

	Blindnieten Rivets aveugles Blind rivets	1.002
	Blindnietmuttern Ecrous de rivets aveugles Blind rivet nuts	1.003
	Rohrnieten Rivets tubulaires Tubular rivets	1.004
	Distanzbolzen Messing vernickelt Entretoises hexagonales laiton nickelé Spacers brass nickel-plated	1.010
	Distanzbolzen Stahl verzinkt Entretoises hexagonales acier zingué Spacers steel zinc-plated	1.013
	Isolier-Distanzbolzen Kunststoff Entretoises hexagonales isolantes plastique Insulating spacers plastic	1.014
	Isolier-Distanzbolzen mit Metall-Gewinde Entretoises hexagonales isolantes avec filet métallique Insulating spacers with metal thread	1.022
	Crimphülsen Douilles à sertir Ferrules	1.026
	Distanzhülsen Metall / Rohrabschnitte Entretoises métal / Pièces tubulaires cylindriques Spacer sleeves metal / Cylindrical tubular pieces	1.028
	Isolier-Distanzrollen Kunststoff Entretoises isolantes plastique Insulating spacer sleeves plastic	1.032
	Kabelbriden Brides de câble Cable clips	1.034
	Klemmscheiben / Klemmbügel Plaquettes de serrage / Etriers de serrage Clamping disks / Clamping straps	1.037
	Scheiben Rondelles Washers	1.040

Blindnieten mit Flachkopf

Rivets aveugles avec tête plate

Blind rivets with a flat head

DIN 7337

* ausgenommen
* excepté
* excepted

Werkstoff:
1099 = Niethülse Aluminium
Nietdorn Stahl verzinkt
8080 = Niethülse rostfreier Stahl
Nietdorn rostfreier Stahl

Matière:
1099 = douille à river aluminium
clou acier zingué
8080 = douille à river acier inox
clou acier inox

Material:
1099 = aluminium riveting sleeve
steel zinc-plated stem
8080 = stainless steel riveting sleeve
stainless steel stem

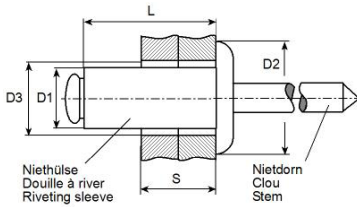

$\varnothing D1$ mm	L mm	S mm	$\varnothing D2$ mm	$\varnothing D3$ mm	DIN	Scherkraft effort tranchant shearing force Nm	Ausreisskraft force d'arrache pull-out strength Nm	Artikelnummer Numéro d'article Part-No.	Werkzeuge Outils Toolings
2.4	4	0.5-2	5	2.5		315	355	fk24040.1099	3954n, 3958n
	5	2-3	5	2.5	*	315	355	fk24050.1099	
	6	2-4	5	2.5		315	355	fk24060.1099	
	8	4-6	5	2.5		315	355	fk24080.1099	
	10	6-8	5	2.5		315	355	fk24100.1099	
3	4	0.5-1.5	6.5	3.1		620	810	fk30040.1099	3954n, 3957n, 3958n
	6	1.5-3.5	6.5	3.1		620	810	fk30060.1099	
	6	1.5-2.5	6.5	3.1		620	810	fk30060.8080	
	8	3.5-5.5	6.5	3.1		620	810	fk30080.1099	
	8	2.5-4.5	6.5	3.1		620	810	fk30080.8080	
	10	5.5-7.5	6.5	3.1		620	810	fk30100.1099	
	10	4.5-6.5	6.5	3.1		620	810	fk30100.8080	
	12	7.5-9.5	6.5	3.1		620	810	fk30120.1099	
	12	6.5-8.5	6.5	3.1		620	810	fk30120.8080	
	14	9.5-11.5	6.5	3.1	*	620	810	fk30140.1099	
	16	11.5-13.5	6.5	3.1		620	810	fk30160.1099	
3.2	4	0.5-1.5	6.5	3.3		760	980	fk32040.1099	3954n, 3957n, 3958n
	4	0.5-1.5	6.5	3.3		760	980	fk32040.8080	
	5	1.5-3	6.5	3.3	*	760	980	fk32050.1099	
	6	1.5-3.5	6.5	3.3		760	980	fk32060.1099	
	6	1.5-2.5	6.5	3.3		760	980	fk32060.8080	
	8	3.5-5.5	6.5	3.3		760	980	fk32080.1099	
	8	2.5-4.5	6.5	3.3		760	980	fk32080.8080	
	10	5.5-7.5	6.5	3.3		760	980	fk32100.1099	
	10	4.5-6.5	6.5	3.3		760	980	fk32100.8080	
	12	7.5-9.5	6.5	3.3		760	980	fk32120.1099	
	12	6.5-8.5	6.5	3.3		760	980	fk32120.8080	
	14	9.5-11.5	6.5	3.3	*	760	980	fk32140.1099	
	15	8.5-12	6.5	3.3		760	980	fk32150.8080	
16	11.5-13.5	6.5	3.3		760	980	fk32160.1099		
18	13.5-15.5	6.5	3.3		760	980	fk32180.1099		
4	5	1-2.5	8	4.1	*	1200	1600	fk40050.1099	3954n, 3957n, 3958n
	6	1.5-3	8	4.1		1200	1600	fk40060.1099	
	6	1.5-2	8	4.1		1200	1600	fk40060.8080	
	8	3-5	8	4.1		1200	1600	fk40080.1099	
	8	2-4	8	4.1		1200	1600	fk40080.8080	
	10	5-6.5	8	4.1		1200	1600	fk40100.1099	
	10	4-6	8	4.1		1200	1600	fk40100.8080	
	12	6.5-8.5	8	4.1		1200	1600	fk40120.1099	
	13	7-9	8	4.1		1200	1600	fk40130.8080	
	14	8.5-10.5	8	4.1		1200	1600	fk40140.1099	
	16	10.5-12.5	8	4.1		1200	1600	fk40160.1099	
	16	10-12	8	4.1		1200	1600	fk40160.8080	
	18	12.5-14.5	8	4.1		1200	1600	fk40180.1099	
	18	12-14	8	4.1		1200	1600	fk40180.8080	
20	14.5-16.5	8	4.1		1200	1600	fk40200.1099		

Blindnietmuttern Ecrus de rivets aveugles Blind rivet nuts

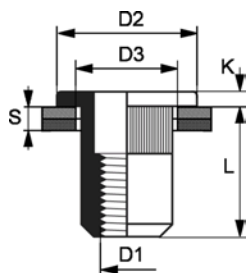

Werkstoff:

.80 = rostfreier Stahl / blank
.99 = Stahl / verzinkt

Matière:

.80 = acier inox / brut
.99 = acier / zingué

Material:

.80 = stainless steel / clean
.99 = steel / zinc-plated

øD1 mm	L mm	S mm	øD2 mm	øD3 mm	K mm	Drehmoment moment de force moment of force Nm	Scherkraft effort tranchant shearing force Nm	Ausreisskraft force d'arrache pull-out strength Nm	Artikelnummer Numéro d'article Part-No.	Werkzeuge Outils Toolings
M3	10	0.5-2.5	7	5	<0.9	3	990	4900	fg30100.99	3955
M4	10	0.5-3	9	6	<1.1	7	2600	7800	fg40100.80	3955, 3956
	10	0.5-3	9	6	<1.1	4.5	1660	7840	fg40100.99	
	11.5	3-4.5	9	6	<1.1	7	2600	7800	fg40115.80	
	11.5	3-5.5	9	6	<1.1	4.5	1660	7840	fg40115.99	
M5	12	0.5-3	10	7	<1.1	12	3920	11760	fg50120.80	3955, 3956
	12	0.5-3	10	7	<1.1	7.8	2760	11070	fg50120.99	
	13.5	3-5.5	10	7	<1.1	12	3920	11760	fg50135.80	
	15	3-5.5	10	7	<1.1	7.8	2760	11070	fg50150.99	
M6	14.5	0.5-3	12	9	<1.6	22.2	5630	20580	fg60145.80	3956
	14.5	0.5-3	12	9	<1.6	20	3430	17640	fg60145.99	
	16	3-5.5	12	9	<1.6	22.2	5630	20580	fg60160.80	
	16	3-5.5	12	9	<1.6	20	3430	17640	fg60160.99	

Werkstoff/Matière/Material
 .1 = Aluminium
 .4 = Kupfer/cuivre/copper
 .6 = Messing/laiton/brass
 .8 = rostfreier Stahl/acier inox/stainless steel
 .9 = Stahl/acier/steel

■ = Oberflächen/Surface/Surface-plating
 Seite/page/page 5.011

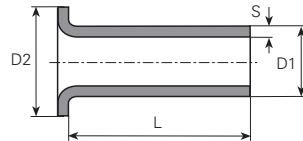

Form A

øD1 mm	S mm	L mm	DIN	Artikelnummer Numéro d'article Part-No.	øD1 mm	S mm	L mm	DIN	Artikelnummer Numéro d'article Part-No.	øD1 mm	S mm	L mm	DIN	Artikelnummer Numéro d'article Part-No.			
0.8	0.2	1	*	a08010020.6	0.8	0.2	3.5		a12035020.6	0.8	0.25	11	*	a15110025.4			
	0.2	1.5	*	a08015020.6		0.2	4		a12040020.6		0.25	11	*	a15110025.6			
	0.2	2	*	a08020020.6		0.2	4.5	*	a12045020.6		0.25	12	*	a15120025.6			
	0.2	2.5	*	a08025020.6		0.2	4.6	*	a12046020.4		0.2	13	*	a15130020.6			
	0.2	3	*	a08030020.6		0.2	5		a12050020.6		0.2	14	*	a15140020.6			
	0.2	3.5	*	a08035020.6		0.2	6		a12060020.6		0.25	14	*	a15140025.6			
	0.2	4	*	a08040020.4		0.2	6.2	*	a12062020.4		0.25	17	*	a15170025.6			
	0.2	4	*	a08040020.6		0.2	6.5	*	a12065020.6		0.25	20	*	a15200025.6			
	0.2	4.5	*	a08045020.6		0.2	7		a12070020.6		0.25	26.5	*	a15265025.4			
	0.2	5	*	a08050020.6		0.2	10		a12100020.6		0.25	30	*	a15300025.6			
	0.2	6	*	a08060020.6		0.2	11	*	a12110020.4		0.25	44	*	a15440025.6			
	0.2	7	*	a08070020.6		0.2	12		a12120020.4		0.25	47	*	a15470025.6			
	0.2	8	*	a08080020.6		0.2	14.5	*	a12145020.6		1.6	0.15	2.5	*	a16025015.6		
	0.2	9	*	a08090020.6		0.2	15		a12150020.6			0.2	2.5	*	a16025020.6		
	0.2	10	*	a08100020.6		0.2	18		a12180020.6			0.2	4	*	a16040020.6		
	1	0.2	1	*		a10010020.6	1.3	0.2	2.5		*	a13025020.6	1.7	0.2	1.6	*	a17016020.4
		0.15	1.5	*		a10015015.6		0.2	6		*	a13060020.6		0.2	3	*	a17030020.6
0.2		1.5	*	a10015020.6	1.4	0.2	2	*	a14020020.6	0.2	4	*		a17040020.6			
0.2		2	*	a10020020.6		0.2	4.5	*	a14045020.6	2	0.2	1.5	*	a20015020.6			
0.15		2.2	*	a10022015.4	1.5	0.25	2		a15020025.6		0.25	1.5	*	a20015025.4			
0.2		2.5	*	a10025020.6		0.2	2.2	*	a15022020.4		0.2	1.8	*	a20018020.6			
0.2		3	*	a10030020.6		0.2	2.5		a15025020.4		0.2	2	*	a20020020.6			
0.2		3.5	*	a10035020.6		0.25	2.5		a15025025.4		0.25	2	*	a20020025.6			
0.2		4	*	a10040020.6		0.25	2.5		a15025025.6		0.3	2	*	a20020030.6			
0.2		4.5	*	a10045020.6		0.2	3		a15030020.4		0.3	2.5	*	a20025030.6			
0.2		5	*	a10050020.6		0.2	3		a15030020.6		0.25	3	*	a20030025.6			
0.2		5.5	*	a10055020.6		0.25	3.2		a15032025.4		0.3	3	*	a20030030.6			
0.2		6	*	a10060020.6		0.2	3.5		a15035020.4		0.25	3.5	*	a20035025.6			
0.2		7	*	a10070020.6		0.2	3.5		a15035020.6		0.3	3.5	*	a20035030.6			
0.2		7.8	*	a10078020.6		0.2	4		a15040020.6		0.25	4	*	a20040025.6			
0.2		8	*	a10080020.6		0.25	4		a15040025.6		0.3	4	*	a20040030.4			
0.2		10	*	a10100020.6		0.2	4.5	*	a15045020.6	0.3	4	*	a20040030.6				
0.2	12	*	a10120020.6	0.2	5		a15050020.6	0.3	4.5	*	a20045030.6						
0.2	13	*	a10130020.6	0.2	5.5	*	a15055020.6	0.3	5	*	a20050030.4						
1.2	0.2	1.5	*	a12015020.4	0.2	6		a15060020.6	0.3	5	*	a20050030.6					
	0.2	2	*	a12020020.4	0.25	6		a15060025.6	0.25	5.5	*	a20055025.6					
	0.2	2	*	a12020020.6	0.2	7		a15070020.6	0.3	6	*	a20060030.6					
	0.2	2.5	*	a12025020.6	0.25	7.5	*	a15075025.4	0.3	6.5	*	a20065030.6					
	0.2	2.8	*	a12028020.4	0.2	8		a15080020.6	0.3	7	*	a20070030.6					
	0.2	3	*	a12030020.6	0.2	10		a15100020.6	0.4	7	*	a20070040.6					

Andere Abmessungen auf Anfrage

Autres dimensions sur demande

Further dimensions on request

Form A

aD1 mm	S mm	L mm	DIN	Artikelnummer Numéro d'article Part-No.	aD1 mm	S mm	L mm	DIN	Artikelnummer Numéro d'article Part-No.	aD1 mm	S mm	L mm	DIN	Artikelnummer Numéro d'article Part-No.	
	0.25	7.5	*	a20075025.6		0.3	8.5	*	a25085030.6		0.5	10		a30100050.6	
	0.3	8		a20080030.6		0.25	9	*	a25090025.6		0.3	11	*	a30110030.6	
	0.4	8	*	a20080040.6		0.3	9	*	a25090030.6		0.3	12		a30120030.6	
	0.3	9	*	a20090030.6		0.4	9	*	a25090040.6		0.3	12		a30120030.9	
	0.4	9	*	a20090040.6		0.3	9.5	*	a25095030.6		0.3	12.4		a30124030.6	
	0.3	9.5	*	a20095030.6		0.25	10		a25100025.6		0.3	13	*	a30130030.6	
	0.3	10		a20100030.6		0.3	10		a25100030.6		0.3	14	*	a30140030.6	
	0.5	10.5		a20105050.6		0.4	10		a25100040.6		0.3	15		a30150030.6	
	0.3	11	*	a20110030.6		0.25	11	*	a25110025.6		0.3	16	*	a30160030.6	
	0.2	12		a20120020.6		0.3	11	*	a25110030.6		0.25	16.2		a30162025.6	
	0.25	12	*	a20120025.6		0.3	11.5	*	a25115030.6		0.25	16.5	*	a30165025.6	
	0.3	12		a20120030.6		0.3	12		a25120030.6		0.3	17	*	a30170030.6	
	0.4	12	*	a20120040.6		0.3	15		a25150030.6		0.3	19	*	a30190030.6	
	0.5	12.5		a20125050.6		0.3	16	*	a25160030.6		0.3	20		a30200030.6	
	0.25	13	*	a20130025.6		0.25	18		a25180025.6		0.25	21.5		a30215025.6	
	0.3	14	*	a20140030.6		0.3	20		a25200030.6		0.3	22	*	a30220030.6	
	0.3	15		a20150030.6		0.3	25		a25250030.6		0.3	23	*	a30230030.6	
	0.25	16	*	a20160025.6		0.3	27	*	a25270030.6		0.3	23.7	*	a30237030.6	
	0.3	16	*	a20160030.6		0.4	30		a25300040.6		0.3	24	*	a30240030.6	
	0.3	18		a20180030.6		0.3	38.5	*	a25385030.6		0.4	25.8		a30258040.6	
	0.4	20	*	a20200040.6		0.3	43	*	a25430030.6		0.3	29	*	a30290030.6	
	0.3	21	*	a20210030.6		0.3	46.5		a25465030.6		0.3	31	*	a30310030.6	
	0.2	22		a20220020.6		2.6	0.2	4	*	a26040020.6		0.3	35		a30350030.6
	0.25	23	*	a20230025.6		2.8	0.3	3.5	*	a28035030.6		0.4	52.5		a30525040.6
	0.3	25		a20250030.6			0.3	4.5	*	a28045030.6	3.2	0.2	18	*	a32180020.6
	0.3	30		a20300030.6			0.3	15.5	*	a28155030.6		0.2	18.5	*	a32185020.6
	0.25	32	*	a20320025.6	3	0.25	2.5	*	a30025025.6	3.5	0.3	4	*	a35040030.6	
	0.2	40		a20400020.6		0.3	3		a30030030.6		0.3	5	*	a35050030.6	
	0.3	50	*	a20500030.6		0.25	3.5		a30035025.6		0.3	6	*	a35060030.6	
2.2	0.15	2.5	*	a22025015.6		0.3	3.5		a30035030.6		0.3	8	*	a35080030.6	
	0.25	2.5	*	a22025025.6		0.5	3.5		a30035050.6		0.3	115	*	a351150030.6	
	0.25	4	*	a22040025.6		0.25	3.8		a30038025.6		0.3	13	*	a35130030.6	
	0.25	5	*	a22050025.6		0.25	4		a30040025.6		0.3	16	*	a35160030.6	
	0.25	17	*	a22170025.6		0.3	4		a30040030.6		0.3	18	*	a35180030.6	
2.4	0.25	5.5	*	a24055025.6		0.25	4.2		a30042025.6		0.3	18.5	*	a35185030.6	
	0.25	15	*	a24150025.6		0.3	4.5	*	a30045030.6		0.3	40	*	a35400030.6	
2.5	0.3	2.5	*	a25025030.6		0.25	5		a30050025.6	3.8	0.3	10.2	*	a38102030.6	
	0.3	3		a25030030.6		0.3	5		a30050030.6		0.3	14.2	*	a38142030.6	
	0.25	3.5		a25035025.6		0.4	5	*	a30050040.6	4	0.2	1.7	*	a40017020.6	
	0.3	3.5		a25035030.6		0.5	5		a30050050.6		0.2	2	*	a40020020.6	
	0.3	4		a25040030.6		0.3	5.5	*	a30055030.6		0.2	2.3	*	a40023020.6	
	0.3	4.5	*	a25045030.10		0.3	6		a30060030.6		0.3	3		a40030030.6	
	0.3	4.5	*	a25045030.6		0.4	6	*	a30060040.6		0.3	3.5	*	a40035030.6	
	0.25	5		a25050025.6		0.3	6.5	*	a30065030.6		0.2	4	*	a40040020.6	
	0.3	5		a25050030.6		0.3	7		a30070030.6		0.4	4		a40040040.6	
	0.4	5		a25050040.6		0.4	7	*	a30070040.6		0.4	5		a40050040.6	
	0.25	5.5	*	a25055025.6		0.3	7.5	*	a30075030.4		0.4	5.5	*	a40055040.6	
	0.3	5.5	*	a25055030.6		0.3	7.5	*	a30075030.6		0.4	6		a40060040.6	
	0.3	6		a25060030.6		0.3	8		a30080030.6		0.4	7		a40070040.6	
	0.3	6.5	*	a25065030.6		0.3	8.5	*	a30085030.6		0.3	7.5	*	a40075030.6	
	0.3	7		a25070030.6		0.3	8.8	*	a30088030.4		0.3	8		a40080030.6	
	0.4	7		a25070040.6		0.3	9	*	a30090030.6		0.4	8		a40080040.6	
	0.25	7.5	*	a25075025.6		0.25	10		a30100025.6		0.2	9		a40090020.6	
	0.3	8		a25080030.6		0.3	10		a30100030.6		0.4	9.6	*	a40096040.6	
	0.4	8		a25080040.6		0.3	10		a30100030.9		0.25	10	*	a40100025.6	

Andere Abmessungen auf Anfrage

Autres dimensions sur demande

Further dimensions on request

Werkstoff/Matière/Material
 .1 = Aluminium
 .4 = Kupfer/cuivre/copper
 .6 = Messing/laiton/brass
 .8 = rostfreier Stahl/acier inox/stainless steel
 .9 = Stahl/acier/steel

■ = Oberflächen/Surface/Surface-plating
 Seite/page/page 5.011

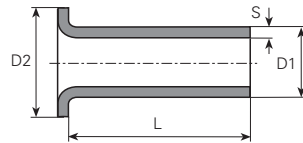

Form A

øD1 mm	S mm	L mm	DIN	Artikelnummer Numéro d'article Part-No.	øD1 mm	S mm	L mm	DIN	Artikelnummer Numéro d'article Part-No.	øD1 mm	S mm	L mm	DIN	Artikelnummer Numéro d'article Part-No.
	0.3	10		a40100030.6■		0.25	4.3	*	a50043025.6■		0.5	10		a60100050.6■
	0.4	10		a40100040.6■		0.5	4.5	*	a50045050.6■		0.5	10		a60100050.9■
	0.4	10.5		a40105040.6■		0.5	5		a50050050.6■		0.5	12.5		a60125050.6■
	0.2	11	*	a40110020.6■		0.5	6.5	*	a50065050.6■		0.25	14	*	a60140025.6■
	0.3	11	*	a40110030.6■		0.5	7		a50070050.6■		0.5	15	*	a60150050.6■
	0.4	12		a40120040.6■		0.5	8		a50080050.6■		0.5	16.5		a60165050.6■
	0.55	12.7		a40127055.10		0.25	10	*	a50100025.6■		0.5	19		a60190050.6■
	0.4	13	*	a40130040.6■		0.5	10		a50100050.6■		0.5	25		a60250050.6■
	0.4	14	*	a40140040.6■		0.5	10		a50100050.9■		0.5	30		a60300050.6■
	0.3	15		a40150030.6■		0.25	11	*	a50110025.6■		0.5	35		a60350050.6■
	0.3	17	*	a40170030.6■		0.5	12		a50120050.6■		0.5	40		a60400050.6■
	0.3	22		a40220030.6■		0.25	13	*	a50130025.6■		0.5	43	*	a60430050.6■
	0.4	25		a40250040.6■		0.5	20		a50200050.4■		0.5	53		a60530050.80
	0.4	28		a40280040.6■		0.35	21		a50210035.6■	7	0.5	9	*	a70090050.6■
						0.35	23	*	a50230035.6■		0.5	15	*	a70150050.6■
						0.5	25		a50250050.6■	7.5	0.25	5	*	a75050025.6■
4.8	0.3	2.7	*	a48027030.6■	6	0.25	3	*	a60030025.6■	8	0.5	10		a80100050.6■
	0.4	4	*	a48040040.6■		0.25	4		a60040025.6■		0.5	15.5	*	a80155050.6■
	0.4	6	*	a48060040.6■		0.25	6	*	a60060025.6■	9	0.3	8	*	a90080030.6■
5	0.25	2.6	*	a50026025.6■		0.25	6	*	a60060025.6■		0.3	10	*	a90100030.6■
	0.25	3	*	a50030025.6■		0.5	8		a60080050.6■	10	0.5	3		a1000300506■
	0.25	4	*	a50040025.6■		0.3	9	*	a60090030.6■					
	0.5	4		a50040050.6■		0.25	10		a60100025.6■					
	0.25	4.2	*	a50042025.6■										

Andere Abmessungen auf Anfrage

Autres dimensions sur demande

Further dimensions on request

Werkstoff/Matière/ Material
 .1 = Aluminium
 .4 = Kupfer/cuivre/copper
 .6 = Messing/laiton/brass
 .8 = rostfreier Stahl/acier inox/stainless steel
 .9 = Stahl/acier/steel

■ = Oberflächen/Surface/Surface-plating
 Seite/page/page 5.011



Form B

øD1 mm	S mm	L mm	DIN	Artikelnummer Numéro d'article Part-No.	øD1 mm	S mm	L mm	DIN	Artikelnummer Numéro d'article Part-No.	øD1 mm	S mm	L mm	DIN	Artikelnummer Numéro d'article Part-No.
1	0.2	1.5	*	b10015020.6	1	0.2	7.5	*	b15075020.6	2	0.3	9	*	b20090030.6
	0.15	2	*	b10020015.4		0.2	8	*	b15080020.6		0.4	9	*	b20090040.6
	0.2	2	*	b10020020.6		0.25	9	*	b15090025.6		0.3	9.5	*	b20095030.6
	0.2	3	*	b10030020.6		0.2	10	*	b15100020.6		0.2	10	*	b20100020.6
	0.2	3.5	*	b10035020.6		0.25	10	*	b15100025.6		0.3	10	*	b20100030.6
	0.2	5	*	b10050020.6		0.2	11	*	b15110020.6		0.3	12	*	b20120030.6
	0.2	9	*	b10090020.6		0.2	12	*	b15120020.6		0.25	13	*	b20130025.6
	0.2	9.5	*	b10095020.6		0.25	13	*	b15130025.6		0.3	13	*	b20130030.6
	0.2	10	*	b10100020.6		0.2	15	*	b15150020.6		0.25	14	*	b20140025.6
	0.2	18	*	b10180020.6		0.25	16	*	b15160025.6		0.3	15	*	b20150030.6
						0.25	24	*	b15240025.6		0.3	23	*	b20230030.6
1.2	0.2	1.5	*	b12015020.6	1.7	0.2	2.3	*	b17023020.6	2.2	0.25	2.5	*	b22025025.6
	0.2	1.6	*	b12016020.4		0.2	2.8	*	b17028020.4		0.25	3	*	b22030025.6
	0.2	2	*	b12020020.4		0.2	3	*	b17030020.6		0.25	3.5	*	b22035025.6
	0.2	2	*	b12020020.6		0.2	7	*	b17070020.6		0.25	4	*	b22040025.6
	0.2	2.5	*	b12025020.6		0.2	8	*	b17080020.6		0.25	4.5	*	b22045025.6
	0.2	3	*	b12030020.6		0.2	9	*	b17090020.6		0.25	5	*	b22050025.6
	0.2	3.5	*	b12035020.6	0.2	11	*	b17110020.6	0.25		5.5	*	b22055025.6	
	0.2	4	*	b12040020.6	2	0.2	2	*	b20020020.6		0.25	6	*	b22060025.6
	0.2	5	*	b12050020.6		0.25	2	*	b20020025.6		0.25	6.5	*	b22065025.6
	0.2	5.5	*	b12055020.6		0.25	2.5	*	b20025025.6		0.25	7	*	b22070025.6
	0.2	8	*	b12080020.6		0.2	3	*	b20030020.6		0.25	8	*	b22080025.6
0.2	9	*	b12090020.6	0.25		3	*	b20030025.6	0.25	8.5	*	b22085025.6		
0.2	10	*	b12100020.6	0.3	3	*	b20030030.6	0.25	9	*	b22090025.6			
0.2	12	*	b12120020.6	0.2	3.5	*	b20035020.6	0.25	9.5	*	b22095025.6			
1.4	0.2	1.2	*	b14012020.6	0.25	3.5	*	b20035025.6	0.25	10	*	b22100025.6		
	0.2	3	*	b14030020.6	0.3	3.5	*	b20035030.6	0.25	16.5	*	b22165025.6		
1.5	0.2	1.5	*	b15015020.6	0.35	3.5	*	b20035035.6	0.25	17	*	b22170025.6		
	0.25	1.7	*	b15017025.6	0.3	3.8	*	b20038030.6	2.3	0.25	3.5	*	b23035025.6	
	0.2	2	*	b15020020.6	0.25	4	*	b20040025.6		0.25	5	*	b23050025.6	
	0.2	2.5	*	b15025020.6	0.3	4	*	b20040030.6		0.25	10	*	b23100025.6	
	0.25	2.5	*	b15025025.6	0.25	4.5	*	b20045025.6	2.4	0.25	2.5	*	b24025025.6	
	0.2	3	*	b15030020.4	0.3	4.5	*	b20045030.6		0.3	4.5	*	b24045030.6	
	0.2	3	*	b15030020.6	0.25	5	*	b20050025.6		0.25	6.5	*	b24065025.6	
	0.25	3	*	b15030025.6	0.3	5	*	b20050030.6		0.25	7	*	b24070025.6	
	0.2	3.5	*	b15035020.6	0.25	5.5	*	b20055025.6		0.25	9	*	b24090025.6	
	0.25	3.5	*	b15035025.4	0.25	6	*	b20060025.6		0.25	10	*	b24100025.6	
	0.25	3.5	*	b15035025.6	0.3	6	*	b20060030.6		0.25	10	*	b24100025.80	
	0.2	4	*	b15040020.6	0.3	6.5	*	b20065030.6		0.25	15	*	b24150025.6	
	0.2	4.5	*	b15045020.6	0.25	7	*	b20070025.6		0.3	15	*	b24150030.6	
	0.2	5	*	b15050020.6	0.3	7	*	b20070030.6		0.3	20	*	b24200030.6	
	0.2	5.5	*	b15055020.6	0.4	7	*	b20070040.6	2.5	0.25	2.5	*	b25025025.6	
	0.25	5.8	*	b15058025.6	0.3	8	*	b20080030.6		0.3	2.5	*	b25025030.6	
	0.2	6.5	*	b15065020.6	0.4	8	*	b20080040.6		0.25	3	*	b25030025.6	
	0.2	7	*	b15070020.6	0.4	8	*	b20080040.6		0.25	3.5	*	b25035025.6	
	0.25	7	*	b15070025.6	0.25	9	*	b20090025.6						

Andere Abmessungen auf Anfrage

Autres dimensions sur demande

Further dimensions on request

Werkstoff/Matière/Material
.1 = Aluminium
.4 = Kupfer/cuivre/copper
.6 = Messing/laiton/brass
.8 = rostfreier Stahl/acier inox/stainless steel
.9 = Stahl/acier/steel

■ = Oberflächen/Surface/Surface-plating
Seite/page/page 5.011

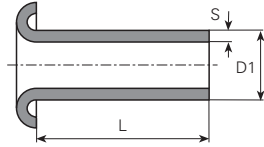

Form B

øD1 mm	S mm	L mm	DIN	Artikelnummer Numéro d'article Part-No.	øD1 mm	S mm	L mm	DIN	Artikelnummer Numéro d'article Part-No.	øD1 mm	S mm	L mm	DIN	Artikelnummer Numéro d'article Part-No.
	0.25	3.5		b25035025.6		0.2	3	*	b26030020.6		0.25	10		b30100025.6
	0.3	3.5		b25035030.6		0.25	4	*	b26040025.6		0.3	10		b30100030.6
	0.25	4		b25040025.6		0.2	4.5	*	b26045020.6		0.5	10		b30100050.6
	0.3	4		b25040030.6		0.2	5	*	b26050020.6		0.3	11	*	b30110030.6
	0.25	4.5	*	b25045025.6		0.2	5.5	*	b26055020.6		0.3	12		b30120030.6
	0.3	4.5	*	b25045030.6		0.2	6	*	b26060020.6		0.3	13	*	b30130030.6
	0.25	5		b25050025.6		0.2	7	*	b26070020.6		0.3	14	*	b30140030.6
	0.3	5.5	*	b25055030.6		0.4	7	*	b26070040.6		0.25	14.5	*	b30145025.6
	0.25	6		b25060025.6		0.2	7.3	*	b26073020.6		0.3	15		b30150030.6
	0.3	6		b25060030.6		0.2	8	*	b26080020.6		0.2	16		b30160020.6
	0.25	6.5	*	b25065025.6		0.2	9.5	*	b26095020.6		0.3	16	*	b30160030.6
	0.3	6.5	*	b25065030.6		0.2	13.2	*	b26132020.6		0.3	17	*	b30170030.6
	0.25	7		b25070025.6	2.8	0.3	6	*	b28060030.6		0.3	18		b30180030.6
	0.3	7		b25070030.6	3	0.25	2	*	b30020025.6		0.5	18		b30180050.6
	0.4	7		b25070040.6		0.3	2.5	*	b30025030.6		0.3	19	*	b30190030.6
	0.25	7.5	*	b25075025.6		0.25	3		b30030025.6		0.3	20		b30200030.6
	0.25	8		b25080025.6		0.3	3		b30030030.6		0.5	20.5		b30205050.80
	0.3	8		b25080030.6		0.25	3.5		b30035025.6		0.3	22		b30220030.6
	0.4	8		b25080040.6		0.3	3.5		b30035030.6		0.2	22.3	*	b30223020.6
	0.3	8.5	*	b25085030.6		0.3	4		b30040030.6		0.3	25		b30250030.6
	0.15	9	*	b25090015.6		0.25	4.5	*	b30045025.6		0.5	25		b30250050.6
	0.25	9	*	b25090025.6		0.5	4.5	*	b30045050.6		0.2	26	*	b30260020.6
	0.3	9	*	b25090030.6		0.25	5		b30050025.6		0.3	26	*	b30260030.6
	0.3	9.5	*	b25095030.6		0.3	5		b30050030.6		0.3	30		b30300030.6
	0.4	9.5	*	b25095040.10		0.4	5	*	b30050040.6		0.5	35		b30350050.6
	0.4	9.5	*	b25095040.6		0.5	5		b30050050.6		0.3	40		b30400030.6
	0.15	10	*	b25100015.6		0.3	5.5	*	b30055030.6	3.2	0.2	5	*	b32050020.6
	0.25	10		b25100025.6		0.25	6		b30060025.6		0.3	6	*	b32060030.6
	0.3	10		b25100030.6		0.3	6		b30060030.6		0.2	7	*	b32070020.6
	0.4	10		b25100040.6		0.5	6		b30060050.6		0.2	8	*	b32080020.6
	0.25	12		b25120025.6		0.2	6.5	*	b30065020.6		0.2	11	*	b32110020.6
	0.25	13	*	b25130025.6		0.25	6.5		b30065025.6		0.2	13	*	b32130020.6
	0.3	14	*	b25140030.6		0.3	6.5	*	b30065030.6		0.2	24.2	*	b32242020.6
	0.4	14	*	b25140040.6		0.2	7	*	b30070020.6	3.5	0.3	3	*	b35030030.6
	0.25	15		b25150025.6		0.25	7		b30070025.6		0.3	3.5	*	b35035030.6
	0.25	17	*	b25170025.6		0.3	7		b30070030.10		0.25	4	*	b35040025.6
	0.3	17	*	b25170030.6		0.3	7		b30070030.6		0.3	4	*	b35040030.6
	0.25	18		b25180025.6		0.3	7.5	*	b30075030.6		0.3	4.5	*	b35045030.6
	0.4	18		b25180040.6		0.25	8		b30080025.6		0.3	5	*	b35050030.6
	0.3	20		b25200030.6		0.3	8		b30080030.6		0.3	5.5	*	b35055030.6
	0.3	22		b25220030.6		0.3	8.5	*	b30085030.6		0.3	6	*	b35060030.6
	0.3	23	*	b25230030.6		0.25	9	*	b30090025.6		0.3	7	*	b35070030.6
	0.3	26	*	b25260030.6		0.3	9	*	b30090030.6		0.3	8	*	b35080030.6
	0.3	33	*	b25330030.6		0.25	9.5	*	b30095025.6		0.3	9	*	b35090030.6
2.6	0.2	2.6	*	b26026020.6		0.2	10		b30100020.6		0.3	10	*	b35100030.6

Andere Abmessungen auf Anfrage

Autres dimensions sur demande

Futher dimensions on request

Form B

$\phi D1$ mm	S mm	L mm	DIN	Artikelnummer Numéro d'article Part-No.	$\phi D1$ mm	S mm	L mm	DIN	Artikelnummer Numéro d'article Part-No.	$\phi D1$ mm	S mm	L mm	DIN	Artikelnummer Numéro d'article Part-No.		
	0.3	11	*	b35110030.6		0.4	19	*	b40190040.6		0.35	12	*	b50120035.6		
	0.3	15	*	b35150030.6		0.4	20	*	b40200040.6		0.5	12	*	b50120050.6		
4	0.3	3	*	b40030030.6		0.8	20	*	b40200080.80		0.25	14	*	b50140025.6		
	0.4	3	*	b40030040.6		0.4	22	*	b40220040.6		0.5	15	*	b50150050.6		
	0.3	3.5	*	b40035030.6		0.4	23	*	b40230040.6		0.5	16	*	b50160050.6		
	0.3	4	*	b40040030.6		0.5	25	*	b40250050.6		0.35	16.6	*	b50166035.6		
	0.3	4.5	*	b40045030.6		0.5	26.5	*	b40265050.6		0.5	17	*	b50170050.6		
	0.3	5	*	b40050030.6		0.4	30	*	b40300040.6		0.5	19	*	b50190050.6		
	0.3	5.5	*	b40055030.6		0.5	30	*	b40300050.6		0.75	20	*	b50200075.6		
	0.3	6	*	b40060030.6		0.4	30.5	*	b40305040.6		0.75	23.5	*	b50235075.80		
	0.4	6	*	b40060040.6		0.3	38	*	b40380030.6		0.75	24	*	b50240075.80		
	0.3	6.2	*	b40062030.6		0.4	38	*	b40380040.6		0.5	40	*	b50400050.6		
	0.3	6.5	*	b40065030.6		0.4	40	*	b40400040.6		5.5	0.5	30.5	*	b55305050.6	
	0.3	7	*	b40070030.6		0.4	42	*	b40420040.6		6	0.25	4	*	b60040025.6	
	0.3	8	*	b40080030.6		0.5	42.5	*	b40425050.6			0.25	5	*	b60050025.6	
	0.4	8	*	b40080040.6		0.5	48.5	*	b40485050.6			0.3	5	*	b60050030.6	
	0.3	9	*	b40090030.6		0.5	50	*	b40500050.6			0.5	5	*	b60050050.6	
	0.4	9	*	b40090040.6		0.5	60	*	b40600050.6			0.25	6	*	b60060025.6	
	0.5	100	*	b4010000506		4.5	0.3	3	*	b45030030.6			0.5	6	*	b60060050.4
	0.3	10	*	b40100030.6			0.25	4	*	b45040025.6			0.5	6	*	b60060050.6
	0.4	10	*	b40100040.6			0.3	10	*	b45100030.6			0.75	7	*	b60070075.4
	0.75	10	*	b40100075.10		0.25	12	*	b45120025.6			0.25	8	*	b60080025.6	
	0.4	10.5	*	b40105040.6		4.8	0.4	8	*	b48080040.6			0.25	9	*	b60090025.6
	0.4	11	*	b40110040.6			5	0.5	4	*	b50040050.6		0.5	12.5	*	b60125050.6
	0.4	12	*	b40120040.6		0.5		4.5	*	b50045050.6		0.25	14	*	b60140025.6	
	0.3	13	*	b40130030.6		0.25		5	*	b50050025.6		0.5	15	*	b60150050.6	
	0.4	13	*	b40130040.6		0.5		5	*	b50050050.6		0.5	20	*	b60200050.6	
	0.5	13.8	*	b40138050.9		0.25		7	*	b50070025.6		0.5	30	*	b60300050.6	
	0.3	14	*	b40140030.6		0.25		8	*	b50080025.6		7.5	0.5	6	*	b75060050.4
0.4	14	*	b40140040.6		0.5	8		*	b50080050.6		8		0.5	6	*	b80060050.6
0.4	16	*	b40160040.6		0.5	8.4		*	b50084050.6			0.5	8	*	b80080050.10	
0.8	16	*	b40160080.80		0.25	10		*	b50100025.6			0.5	10	*	b80100050.6	
0.2	18	*	b40180020.6		0.5	10		*	b50100050.6							

Andere Abmessungen auf Anfrage

Autres dimensions sur demande

Futher dimensions on request

Werkstoff/Matière/Material

.4 = Kupfer/cuivre/copper

.8 = rostfreier Stahl/acier inox/stainless steel

■ = Oberflächen/Surface/Surface-plating
Seite/page/page 5.011

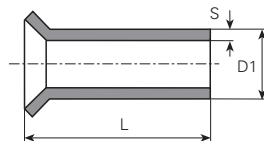

Form C

$\phi D1$ mm	S mm	L mm	DIN	Artikelnummer Numéro d'article Part-No.	$\phi D1$ mm	S mm	L mm	DIN	Artikelnummer Numéro d'article Part-No.	$\phi D1$ mm	S mm	L mm	DIN	Artikelnummer Numéro d'article Part-No.
1	0.2	6.3	*	c10063020.4	1.7	0.2	4	*	c17040020.4	4.5	0.5	9	*	c45090050.80

Andere Abmessungen auf Anfrage

Autres dimensions sur demande

Futher dimensions on request

Distanz-Bolzen Messing vernickelt
Entretoises hexagonales laiton nickelé
Spacers brass nickel-plated

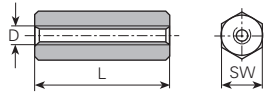

mit Innengewinde durchgehend / avec tige fileté / internal thread

øD mm	L mm	SW mm	Artikelnummer Numéro d'article Part-No.	øD mm	L mm	SW mm	Artikelnummer Numéro d'article Part-No.	øD mm	L mm	SW mm	Artikelnummer Numéro d'article Part-No.
M2	4	4	m20004.00.65	7	7	5	m30007.00.65	20	5	5	m30020.00.65
	5	4	m20005.00.65		7	5.5	m30007.50.65		5.5	m30020.50.65	
	6	4	m20006.00.65		8	5	m30008.00.65		5	m30021.00.65	
	7	4	m20007.00.65		8	5.5	m30008.50.65		5	m30022.00.65	
	8	4	m20008.00.65		9	5	m30009.00.65	M4	10	7	m40010.00.65
	10	4	m20010.00.65		10	5	m30010.00.65		12	7	m40012.00.65
	12	4	m20012.00.65		10	5.5	m30010.50.65		13	7	m40013.00.60
	15	4	m20015.00.65		11	5	m30011.00.65		14	7	m40014.00.65
	18	4	m20018.00.65		11	5.5	m30011.50.65		15	7	m40015.00.60
	20	4	m20020.00.65		12	5	m30012.00.65		15	7	m40015.00.65
M2.5	5	5	m25005.00.65		12	5.5	m30012.50.65		16	7	m40016.00.65
	8	5	m25008.00.65		13	5	m30013.00.65		18	7	m40018.00.65
	9	5	m25009.00.65	13	5.5	m30013.50.65	19		7	m40019.00.65	
	10	5	m25010.00.65	14	5	m30014.00.65	20		7	m40020.00.65	
	12	5	m25012.00.65	14	5.5	m30014.50.65	21	7	m40021.00.65		
	15	5	m25015.00.65	15	5	m30015.00.65	M5	8	8	m50008.00.65	
	18	5	m25018.00.65	15	5.5	m30015.50.65		10	8	m50010.00.65	
20	5	m25020.00.65	16	5	m30016.00.65	12		8	m50012.00.65		
M3	5	5	m30005.00.65	17	5	m30017.00.65		15	8	m50015.00.65	
	5	5.5	m30005.50.65	18	5	m30018.00.65	20	8	m50020.00.65		
	6	5	m30006.00.65	18	5.5	m30018.50.65					
	6	5.5	m30006.50.65	19	5	m30019.00.65					

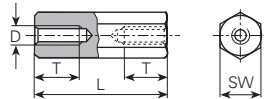

mit Innengewinde beidseitig / avec filet femelle des deux côtés / with internal thread on both sides

øD mm	L mm	SW mm	T mm	Artikelnummer Numéro d'article Part-No.	øD mm	L mm	SW mm	T mm	Artikelnummer Numéro d'article Part-No.	øD mm	L mm	SW mm	T mm	Artikelnummer Numéro d'article Part-No.
M2	25	4	10	m20025.00.65	38	5	10	m30038.00.65	60	7	10	m40060.00.65		
	30	4	10	m20030.00.65		40	5	10		m30040.00.65	7	10	m40070.00.65	
	35	4	10	m20035.00.65		40	5.5	10		m30040.50.65	8	10	m40080.00.65	
	40	4	10	m20040.00.65		45	5	10		m30045.00.65	9	10	m40090.00.65	
	45	4	10	m20045.00.65		45	5.5	10		m30045.50.65	9	10	m40095.00.65	
	M2.5	25	5	10		m25025.00.65	50	5		10	m30050.00.65	M5	25	8
30		5	10	m25030.00.65		50	5.5	10	m30050.50.65	30	8		10	m50030.00.65
35		5	10	m25035.00.65		55	5.5	10	m30055.00.65	35	8		10	m50035.00.65
40		5	10	m25040.00.65		55	5	10	m30055.50.65	40	8		10	m50040.00.65
45		5	10	m25045.00.65		60	5	10	m30060.00.65	45	8		10	m50045.00.65
M3		25	5	10		m30025.00.65	60	5.5	10	m30060.50.65	50		8	10
	25	5.5	10	m30025.50.65		M4	25	7	10	m40025.00.65	55		8	10
	27	5	10	m30027.00.65	30		7	10	m40030.00.65	60	8		10	m50060.00.65
	30	5	10	m30030.00.65	35		7	10	m40035.00.65	70	8		10	m50070.00.65
	30	5.5	10	m30030.50.65	40		7	10	m40040.00.65	80	8		10	m50080.00.65
	33	5	10	m30033.00.65	45		7	10	m40045.00.65	90	8	10	m50090.00.65	
	35	5	10	m30035.00.65	50		7	10	m40050.00.65	100	8	10	m50100.00.65	
	35	5.5	10	m30035.50.65	55		7	10	m40055.00.65					
	37	5	10	m30037.00.65	58		7	10	m40058.00.65					

Andere Abmessungen auf Anfrage

Autres dimensions sur demande

Further dimensions on request

Distanz-Bolzen Messing vernickelt
Entretoises hexagonales laiton nickelé
Spacers brass nickel-plated

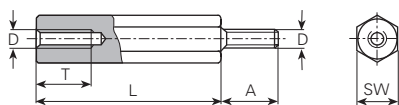

mit Innen- und Aussengewinde / avec filet femelle et mâle / with internal and external thread					
øD mm	L mm	SW mm	T mm	A mm	Artikelnummer Numéro d'article Part-No.
M2	5	4	2.5	6	m20005.01.65
	8	4	5	6	m20008.01.65
	10	4	5	6	m20010.01.65
	12	4	6	6	m20012.01.65
	15	4	6	6	m20015.01.65
	18	4	6	6	m20018.01.65
	20	4	6	6	m20020.01.65
	25	4	6	6	m20025.01.65
	30	4	6	6	m20030.01.65
	35	4	6	6	m20035.01.65
40	4	6	6	m20040.01.65	
M2.5	5	5	3	6	m25005.01.65
	8	5	5	6	m25008.01.65
	9	5	5	6	m25009.01.65
	10	5	5	6	m25010.01.65
	11	5	5	6	m25011.01.65
	12	5	6	6	m25012.01.65
	16	5	6	6	m25016.01.65
	18	5	6	6	m25018.01.65
	20	5	6	6	m25020.01.65
	25	5	6	6	m25025.01.65
	30	5	6	6	m25030.01.65
	35	5	6	6	m25035.01.65
	40	5	6	6	m25040.01.65
	M3	5	5	3	5
5		5.5	3	8	m30005.51.65
8		5	5	6	m30008.01.65
8		5.5	5	8	m30008.51.65
10		5	6	8	m30010.01.65
10		5.5	6	8	m30010.51.65
11		5	6	8	m30011.01.65
11		5.5	6	8	m30011.51.65
12		5	8	8	m30012.01.65
12		5.5	8	8	m30012.51.65
14		5	8	8	m30014.01.65
14		5.5	8	8	m30014.51.65
15		5	8	8	m30015.01.65
15		5.5	8	8	m30015.51.65
16		5	8	8	m30016.01.65
17		5	8	8	m30017.01.65
18		5	8	8	m30018.01.65
18		5.5	8	8	m30018.51.65
20		5	8	8	m30020.01.65
20		5.5	8	8	m30020.51.65
22		5	10	8	m30022.01.65
25		5	10	10	m30025.01.65
25	5.5	10	10	m30025.51.65	
30	5	10	10	m30030.01.65	
M4	5	7	3	8	m40005.01.65
	10	7	5	8	m40010.01.65
	12	7	8	8	m40012.01.65
	14	7	10	8	m40014.01.65
	15	7	10	8	m40015.01.65
	16	7	10	8	m40016.01.65
	18	7	10	8	m40018.01.65
	20	7	10	8	m40020.01.65
	22	7	10	8	m40022.01.65
	25	7	10	10	m40025.01.65
	30	7	10	10	m40030.01.65
	35	7	10	10	m40035.01.65
	40	7	10	10	m40040.01.65
	45	7	10	10	m40045.01.65
	50	7	10	10	m40050.01.65
	55	7	10	10	m40055.01.65
	60	7	10	10	m40060.01.65
	70	7	10	10	m40070.01.65
80	7	10	10	m40080.01.65	
100	7	10	10	m40100.01.65	
M5	10	8	6	8	m50010.01.65
	15	8	10	8	m50015.01.65
	16	8	10	8	m50016.01.65
	18	8	10	8	m50018.01.65
	20	8	10	8	m50020.01.65
	25	8	10	10	m50025.01.65
	30	8	10	10	m50030.01.65
	35	8	10	10	m50035.01.65
	40	8	10	10	m50040.01.65
	45	8	10	10	m50045.01.65
	50	8	10	10	m50050.01.65
	55	8	10	10	m50055.01.65
	60	8	10	10	m50060.01.65
	70	8	10	10	m50070.01.65
	80	8	10	10	m50080.01.65
	90	8	10	10	m50090.01.65
	100	8	10	10	m50100.01.65

Andere Abmessungen auf Anfrage

Autres dimensions sur demande

Further dimensions on request

Distanz-Bolzen UNC 4-40

Entretoises hexagonales UNC 4-40

Spacers UNC 4-40

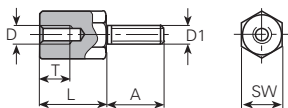

Werkstoff/Matière/Material:

.65 = Messing vernickelt / laiton nickelé / brass nickel-plated

.99 = Stahl verzinkt / acier zingué / steel zinc-plated

mit Innen- und Aussengewinde / avec filet femelle et mâle / with internal and external thread

$\varnothing D$ mm	$\varnothing D1$ mm	L mm	SW mm	T mm	A mm	Artikelnummer Numéro d'article Part-No.
UNC 4-40	UNC 4-40	4.6	5	3.2	8	7663.99
	UNC 4-40	5	5	3.5	8	7666.65
	UNC 4-40	6	5	4.5	5	7672.65
	M3	6.2	5	4.5	8	7664.65
	M3	6.2	4.5	4.5	3.6	7668.65
	M3	5	5	3	8	7671.99
	M3	5	4.5	2.6	7	7682.99
M3	UNC 4-40	6	5	4	4	7669.65

Distanz-Bolzen Stahl verzinkt
Entretoises hexagonales acier zingué
Spacers steel zinc-plated

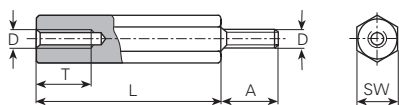

mit Innen-und Aussengewinde / avec filet femelle et mâle / with internal and external thread

øD mm	L mm	SW mm	T mm	A mm	Artikelnummer Numéro d'article Part-No.	øD mm	L mm	SW mm	T mm	A mm	Artikelnummer Numéro d'article Part-No.	
M6	10	9	5	10	m60010.01.99		70	9	10	10	m60070.01.99	
	10	10	5	10	m60010.51.99		70	10	10	10	m60070.51.99	
	15	9	10	10	m60015.01.99		75	9	10	10	m60075.01.99	
	15	10	10	10	m60015.51.99		75	10	10	10	m60075.51.99	
	18	9	10	10	m60018.01.99		80	9	10	10	m60080.01.99	
	20	9	10	10	m60020.01.99		80	10	10	10	m60080.51.99	
	20	10	10	10	m60020.51.99		85	9	10	10	m60085.01.99	
	25	9	10	10	m60025.01.99		85	10	10	10	m60085.51.99	
	25	10	10	10	m60025.51.99		90	9	10	10	m60090.01.99	
	30	9	10	10	m60030.01.99		90	10	10	10	m60090.51.99	
	30	10	10	10	m60030.51.99		95	9	10	10	m60095.01.99	
	35	9	10	10	m60035.01.99		95	10	10	10	m60095.51.99	
	35	10	10	10	m60035.51.99		100	9	10	10	m60100.01.99	
	40	9	10	10	m60040.01.99		100	10	10	10	m60100.51.99	
	40	10	10	10	m60040.51.99		110	9	10	10	m60110.01.99	
	45	9	10	10	m60045.01.99		110	10	10	10	m60110.51.99	
	45	10	10	10	m60045.51.99		120	9	10	10	m60120.01.99	
	48	9	10	10	m60048.01.99		120	10	10	10	m60120.51.99	
	48	10	10	10	m60048.51.99		130	9	10	10	m60130.01.99	
	50	9	10	10	m60050.01.99		130	10	10	10	m60130.51.99	
	50	10	10	10	m60050.51.99		140	9	10	10	m60140.01.99	
	55	9	10	10	m60055.01.99		140	10	10	10	m60140.51.99	
	55	10	10	10	m60055.51.99		150	9	10	10	m60150.01.99	
	60	9	10	10	m60060.01.99		150	10	10	10	m60150.51.99	
	60	10	10	10	m60060.51.99		160	9	10	10	m60160.01.99	
	65	9	10	10	m60065.01.99		160	10	10	10	m60160.51.99	
	65	10	10	10	m60065.51.99							

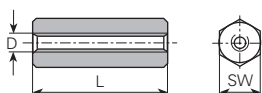

mit Innengewinde durchgehend / avec tige filetée / internal thread

øD mm	L mm	SW mm	T mm	A mm	Artikelnummer Numéro d'article Part-No.
M6	15	9			m60015.00.99
	20	9			m60020.00.99
	25	9			m60025.00.99

Andere Abmessungen auf Anfrage

Autres dimensions sur demande

Further dimensions on request

Isolier Distanz-Bolzen Kunststoff

Entretoises hexagon. isol.

Insulating spacers

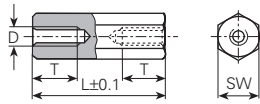

Werkstoff:
pa = Polyamid, schwarz

Matière:
pa = polyamide, noire

Material:
pa = polyamid, black

Temperaturbeständigkeit:
-40°C bis +110°C

Résistant à une température de:
-40°C à +110°C

Temperature range:
-40°C up to +110°C

mit Innengewinde beidseitig / avec filet femelle des deux côtés / with internal thread on both sides

øD mm	L mm	SW mm	T mm	Artikelnummer Numéro d'article Part-No.	øD mm	L mm	SW mm	T mm	Artikelnummer Numéro d'article Part-No.
M2.5	6	5	3	m25006.00.pa		27	6	10	m30027.00.pa
	7	5	3.5	m25007.00.pa		28	6	10	m30028.00.pa
	8	5	4	m25008.00.pa		29	6	10	m30029.00.pa
	9	5	4.5	m25009.00.pa		30	6	10	m30030.00.pa
	10	5	5	m25010.00.pa		31	6	10	m30031.00.pa
	11	5	5.5	m25011.00.pa		32	6	10	m30032.00.pa
	12	5	6	m25012.00.pa		33	6	10	m30033.00.pa
	13	5	6.5	m25013.00.pa		34	6	10	m30034.00.pa
	14	5	7	m25014.00.pa		35	6	10	m30035.00.pa
	15	5	7.5	m25015.00.pa		36	6	10	m30036.00.pa
	16	5	8	m25016.00.pa		37	6	10	m30037.00.pa
	17	5	8.5	m25017.00.pa		38	6	10	m30038.00.pa
	18	5	9	m25018.00.pa		40	6	10	m30040.00.pa
	19	5	9.5	m25019.00.pa		42	6	10	m30042.00.pa
	20	5	10	m25020.00.pa		44	6	10	m30044.00.pa
	21	5	10	m25021.00.pa		46	6	10	m30046.00.pa
	22	5	10	m25022.00.pa		48	6	10	m30048.00.pa
	23	5	10	m25023.00.pa		50	6	10	m30050.00.pa
	24	5	10	m25024.00.pa		55	6	10	m30055.00.pa
	25	5	10	m25025.00.pa		60	6	10	m30060.00.pa
26	5	10	m25026.00.pa	65	6	10	m30065.00.pa		
M3	6	6	3	m30006.00.pa	M4	10	8	5	m40010.00.pa
	7	6	3.5	m30007.00.pa		11	8	5.5	m40011.00.pa
	8	6	4	m30008.00.pa		12	8	6	m40012.00.pa
	9	6	4.5	m30009.00.pa		13	8	6.5	m40013.00.pa
	10	6	5	m30010.00.pa		14	8	7	m40014.00.pa
	11	6	5.5	m30011.00.pa		15	8	7.5	m40015.00.pa
	12	6	6	m30012.00.pa		16	8	8	m40016.00.pa
	13	6	6.5	m30013.00.pa		17	8	8.5	m40017.00.pa
	14	6	7	m30014.00.pa		18	8	9	m40018.00.pa
	15	6	7.5	m30015.00.pa		19	8	9.5	m40019.00.pa
	16	6	8	m30016.00.pa		20	8	10	m40020.00.pa
	17	6	8.5	m30017.00.pa		21	8	10	m40021.00.pa
	18	6	9	m30018.00.pa		22	8	10	m40022.00.pa
	19	6	9.5	m30019.00.pa		23	8	10	m40023.00.pa
	20	6	10	m30020.00.pa		24	8	10	m40024.00.pa
	21	6	10	m30021.00.pa		25	8	10	m40025.00.pa
	22	6	10	m30022.00.pa		26	8	10	m40026.00.pa
	23	6	10	m30023.00.pa		27	8	10	m40027.00.pa
	24	6	10	m30024.00.pa		28	8	10	m40028.00.pa
	25	6	10	m30025.00.pa		29	8	10	m40029.00.pa
26	6	10	m30026.00.pa	30	8	10	m40030.00.pa		
				32	8	10	m40032.00.pa		
				34	8	10	m40034.00.pa		
				36	8	10	m40036.00.pa		
				38	8	10	m40038.00.pa		

Andere Abmessungen auf Anfrage

Autres dimensions sur demande

Further dimensions on request



Verbindungstechnik

Isolier Distanz-Bolzen Kunststoff Entretôises hexagon. isol. Insulating spacers

mit Innengewinde beidseitig / avec file femelle des deux côtés / with internal thread on both sides									
øD mm	L mm	SW mm	T mm	Artikelnummer Numéro d'article Part-No.	øD mm	L mm	SW mm	T mm	Artikelnummer Numéro d'article Part-No.
	40	8	10	m40040.00.pa		50	8	10	m40050.00.pa
	42	8	10	m40042.00.pa		55	8	10	m40055.00.pa
	44	8	10	m40044.00.pa		60	8	10	m40060.00.pa
	46	8	10	m40046.00.pa		65	8	10	m40065.00.pa
	48	8	10	m40048.00.pa					

Andere Abmessungen auf Anfrage

Autres dimensions sur demande

Further dimensions on request

Isolier Distanz-Bolzen Kunststoff

Entretoises hexagon. isol.

Insulating spacers



Werkstoff:
pa = Polyamid, schwarz

Matière:
pa = polyamide, noire

Material:
pa = polyamid, black

Temperaturbeständigkeit:
-40°C bis +110°C

Résistant à une température de:
-40°C à +110°C

Temperature range:
-40°C up to +110°C

mit Innen- und Aussengewinde / avec filet femelle et mâle / with internal and external thread

øD mm	L mm	SW mm	T mm	A mm	Artikelnummer Numéro d'article Part-No.	øD mm	L mm	SW mm	T mm	A mm	Artikelnummer Numéro d'article Part-No.
M3	6	6	3.5	8	m30006.01.pa	M4	10	8	7	8	m40010.01.pa
	8	6	5	8	m30008.01.pa		11	8	7	8	m40011.01.pa
	9	6	6	5	m30009.01.pa		12	8	7	8	m40012.01.pa
	10	6	7	8	m30010.01.pa		13	8	10	8	m40013.01.pa
	11	6	7	8	m30011.01.pa		14	8	10	8	m40014.01.pa
	12	6	9	8	m30012.01.pa		15	8	10	8	m40015.01.pa
	13	6	9	8	m30013.01.pa		16	8	10	8	m40016.01.pa
	14	6	9	8	m30014.01.pa		17	8	10	8	m40017.01.pa
	15	6	10	8	m30015.01.pa		18	8	10	8	m40018.01.pa
	16	6	10	8	m30016.01.pa		19	8	10	8	m40019.01.pa
	17	6	10	8	m30017.01.pa		20	8	10	8	m40020.01.pa
	18	6	10	8	m30018.01.pa		21	8	10	8	m40021.01.pa
	19	6	10	8	m30019.01.pa		22	8	10	8	m40022.01.pa
	20	6	10	8	m30020.01.pa		23	8	10	8	m40023.01.pa
	21	6	10	8	m30021.01.pa		24	8	10	8	m40024.01.pa
	22	6	10	8	m30022.01.pa		25	8	10	8	m40025.01.pa
	23	6	10	8	m30023.01.pa		26	8	10	8	m40026.01.pa
	24	6	10	8	m30024.01.pa		27	8	10	8	m40027.01.pa
	25	6	10	8	m30025.01.pa		28	8	10	8	m40028.01.pa
	26	6	10	8	m30026.01.pa		29	8	10	8	m40029.01.pa
27	6	10	8	m30027.01.pa	30	8	10	8	m40030.01.pa		
28	6	10	8	m30028.01.pa	32	8	10	8	m40032.01.pa		
29	6	10	8	m30029.01.pa	34	8	10	8	m40034.01.pa		
30	6	10	8	m30030.01.pa	36	8	10	8	m40036.01.pa		
32	6	10	8	m30032.01.pa	38	8	10	8	m40038.01.pa		
34	6	10	8	m30034.01.pa	40	8	10	8	m40040.01.pa		
36	6	10	8	m30036.01.pa	45	8	10	8	m40045.01.pa		
38	6	10	8	m30038.01.pa	50	8	10	8	m40050.01.pa		
40	6	10	8	m30040.01.pa	55	8	10	8	m40055.01.pa		
41	6	10	8	m30041.01.pa	60	8	10	8	m40060.01.pa		
45	6	10	8	m30045.01.pa	65	8	10	8	m40065.01.pa		
50	6	10	8	m30050.01.pa							

Andere Abmessungen auf Anfrage

Autres dimensions sur demande

Further dimensions on request

Isolier Distanz-Bolzen Kunststoff

Entretoises hexagon. isol.

Insulating spacers

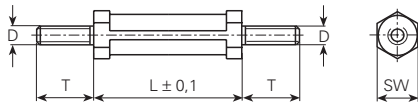

Werkstoff:
pa = Polyamid, schwarz

Matière:
pa = polyamide, noire

Material:
pa = polyamid, black

Temperaturbeständigkeit:
-40°C bis +110°C

Résistant à une température de:
-40°C à +110°C

Temperature range:
-40°C up to +110°C

mit Aussengewinde beidseitig / avec filet mâle des deux côtés / with external thread on both sides

øD mm	L mm	SW mm	T mm	Artikelnummer Numéro d'article Part-No.	øD mm	L mm	SW mm	T mm	Artikelnummer Numéro d'article Part-No.
M3	5	6	6	m30005.11.pa	M4	5	6	6.4	m40005.11.pa
	6	6	6	m30006.11.pa		6	6	6.4	m40006.11.pa
	7	6	6	m30007.11.pa		7	6	6.4	m40007.11.pa
	8	6	6	m30008.11.pa		8	6	6.4	m40008.11.pa
	9	6	6	m30009.11.pa		9	6	6.4	m40009.11.pa
	10	6	6	m30010.11.pa		10	6	6.4	m40010.11.pa
	11	6	6	m30011.11.pa		11	6	6.4	m40011.11.pa
	12	6	6	m30012.11.pa		12	6	6.4	m40012.11.pa
	13	6	6	m30013.11.pa		13	6	6.4	m40013.11.pa
	14	6	6	m30014.11.pa		14	6	6.4	m40014.11.pa
	15	6	6	m30015.11.pa		15	6	6.4	m40015.11.pa
	16	6	6	m30016.11.pa		16	6	6.4	m40016.11.pa
	17	6	6	m30017.11.pa		17	6	6.4	m40017.11.pa
	18	6	6	m30018.11.pa		18	6	6.4	m40018.11.pa
	19	6	6	m30019.11.pa		19	6	6.4	m40019.11.pa
	20	6	6	m30020.11.pa		20	6	6.4	m40020.11.pa
	21	6	6	m30021.11.pa		21	6	6.4	m40021.11.pa
	22	6	6	m30022.11.pa		22	6	6.4	m40022.11.pa
	23	6	6	m30023.11.pa		23	6	6.4	m40023.11.pa
	24	6	6	m30024.11.pa		24	6	6.4	m40024.11.pa
	25	6	6	m30025.11.pa		25	6	6.4	m40025.11.pa
	26	6	6	m30026.11.pa		26	6	6.4	m40026.11.pa
	27	6	6	m30027.11.pa		27	6	6.4	m40027.11.pa
	28	6	6	m30028.11.pa		28	6	6.4	m40028.11.pa
	29	6	6	m30029.11.pa		29	6	6.4	m40029.11.pa
	30	6	6	m30030.11.pa		30	6	6.4	m40030.11.pa
	31	6	6	m30031.11.pa		31	6	6.4	m40031.11.pa
	32	6	6	m30032.11.pa		32	6	6.4	m40032.11.pa
	33	6	6	m30033.11.pa		33	6	6.4	m40033.11.pa
	34	6	6	m30034.11.pa		34	6	6.4	m40034.11.pa
	35	6	6	m30035.11.pa		35	6	6.4	m40035.11.pa
	36	6	6	m30036.11.pa		36	6	6.4	m40036.11.pa

Andere Abmessungen auf Anfrage

Autres dimensions sur demande

Further dimensions on request

Isolier Distanz-Bolzen Kunststoff

Entretoises hexagon. isol.

Insulating spacers

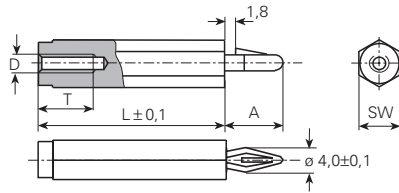

Werkstoff:
pa = Polyamid, schwarz

Matière:
pa = polyamide, noire

Material:
pa = polyamid, black

Temperaturbeständigkeit:
-40°C bis +110°C

Résistant à une température de:
-40°C à +110°C

Temperature range:
-40°C up to +110°C

einschnappbar mit Innengewinde / encliquante avec filet femelle / snap in form with internal thread

øD mm	L mm	SW mm	T mm	A mm	Artikelnummer Numéro d'article Part-No.	øD mm	L mm	SW mm	T mm	A mm	Artikelnummer Numéro d'article Part-No.	
M3	6	8	3	9.5	m30e06.00.pa		30	8	10	9.5	m30e30.00.pa	
	7	8	3.5	9.5	m30e07.00.pa		31	8	10	9.5	m30e31.00.pa	
	8	8	4	9.5	m30e08.00.pa		32	8	10	9.5	m30e32.00.pa	
	9	8	4.5	9.5	m30e09.00.pa		33	8	10	9.5	m30e33.00.pa	
	10	8	5	9.5	m30e10.00.pa		34	8	10	9.5	m30e34.00.pa	
	11	8	5.5	9.5	m30e11.00.pa		35	8	10	9.5	m30e35.00.pa	
	12	8	6	9.5	m30e12.00.pa		36	8	10	9.5	m30e36.00.pa	
	13	8	6.5	9.5	m30e13.00.pa		37	8	10	9.5	m30e37.00.pa	
	14	8	7	9.5	m30e14.00.pa		38	8	10	9.5	m30e38.00.pa	
	15	8	7.5	9.5	m30e15.00.pa		39	8	10	9.5	m30e39.00.pa	
	16	8	8	9.5	m30e16.00.pa		40	8	10	9.5	m30e40.00.pa	
	17	8	8.5	9.5	m30e17.00.pa		41	8	10	9.5	m30e41.00.pa	
	18	8	9	9.5	m30e18.00.pa		42	8	10	9.5	m30e42.00.pa	
	19	8	9.5	9.5	m30e19.00.pa		43	8	10	9.5	m30e43.00.pa	
	20	8	10	9.5	m30e20.00.pa		44	8	10	9.5	m30e44.00.pa	
	21	8	10	9.5	m30e21.00.pa		45	8	10	9.5	m30e45.00.pa	
	22	8	10	9.5	m30e22.00.pa		46	8	10	9.5	m30e46.00.pa	
	23	8	10	9.5	m30e23.00.pa		47	8	10	9.5	m30e47.00.pa	
	24	8	10	9.5	m30e24.00.pa		48	8	10	9.5	m30e48.00.pa	
	25	8	10	9.5	m30e25.00.pa		49	8	10	9.5	m30e49.00.pa	
	26	8	10	9.5	m30e26.00.pa		50	8	10	9.5	m30e50.00.pa	
	27	8	10	9.5	m30e27.00.pa		M4	14	8	9	9.5	m40e14.00.pa
	28	8	10	9.5	m30e28.00.pa			18	8	9	9.5	m40e18.00.pa
	29	8	10	9.5	m30e29.00.pa							

Andere Abmessungen auf Anfrage

Autres dimensions sur demande

Further dimensions on request

Isolier Distanz-Bolzen Kunststoff

Entretoises hexagon. isol.

Insulating spacers

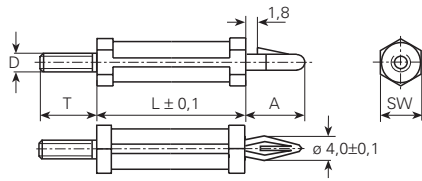

Werkstoff:
pa = Polyamid, schwarz

Matière:
pa = polyamide, noire

Material:
pa = polyamid, black

Temperaturbeständigkeit:
-40°C bis +110°C

Résistant à une température de:
-40°C à +110°C

Temperature range:
-40°C up to +110°C

einschnappbar mit Aussengewinde / encliquante avec filet mâle / snap in form with external thread

øD mm	L mm	SW mm	T mm	A mm	Artikelnummer Numéro d'article Part-No.	øD mm	L mm	SW mm	T mm	A mm	Artikelnummer Numéro d'article Part-No.
M3	5	6	6	9.5	m30d05.01.pa	M4	5	8	6.4	9.5	m40d05.01.pa
	6	6	6	9.5	m30d06.01.pa		6	8	6.4	9.5	m40d06.01.pa
	7	6	6	9.5	m30d07.01.pa		7	8	6.4	9.5	m40d07.01.pa
	8	6	6	9.5	m30d08.01.pa		8	8	6.4	9.5	m40d08.01.pa
	9	6	6	9.5	m30d09.01.pa		9	8	6.4	9.5	m40d09.01.pa
	10	6	6	9.5	m30d10.01.pa		10	8	6.4	9.5	m40d10.01.pa
	11	6	6	9.5	m30d11.01.pa		11	8	6.4	9.5	m40d11.01.pa
	12	6	6	9.5	m30d12.01.pa		12	8	6.4	9.5	m40d12.01.pa
	13	6	6	9.5	m30d13.01.pa		13	8	6.4	9.5	m40d13.01.pa
	14	6	6	9.5	m30d14.01.pa		14	8	6.4	9.5	m40d14.01.pa
	15	6	6	9.5	m30d15.01.pa		15	8	6.4	9.5	m40d15.01.pa
	16	6	6	9.5	m30d16.01.pa		16	8	6.4	9.5	m40d16.01.pa
	17	6	6	9.5	m30d17.01.pa		17	8	6.4	9.5	m40d17.01.pa
	18	6	6	9.5	m30d18.01.pa		18	8	6.4	9.5	m40d18.01.pa
	19	6	6	9.5	m30d19.01.pa		19	8	6.4	9.5	m40d19.01.pa
	20	6	6	9.5	m30d20.01.pa		20	8	6.4	9.5	m40d20.01.pa
	21	6	6	9.5	m30d21.01.pa		21	8	6.4	9.5	m40d21.01.pa
	22	6	6	9.5	m30d22.01.pa		22	8	6.4	9.5	m40d22.01.pa
	23	6	6	9.5	m30d23.01.pa		23	8	6.4	9.5	m40d23.01.pa
	24	6	6	9.5	m30d24.01.pa		24	8	6.4	9.5	m40d24.01.pa
	25	6	6	9.5	m30d25.01.pa		25	8	6.4	9.5	m40d25.01.pa
	26	6	6	9.5	m30d26.01.pa		26	8	6.4	9.5	m40d26.01.pa
	27	6	6	9.5	m30d27.01.pa		27	8	6.4	9.5	m40d27.01.pa
	28	6	6	9.5	m30d28.01.pa		28	8	6.4	9.5	m40d28.01.pa
	29	6	6	9.5	m30d29.01.pa		29	8	6.4	9.5	m40d29.01.pa
	30	6	6	9.5	m30d30.01.pa		30	8	6.4	9.5	m40d30.01.pa
	31	6	6	9.5	m30d31.01.pa		31	8	6.4	9.5	m40d31.01.pa
	32	6	6	9.5	m30d32.01.pa		32	8	6.4	9.5	m40d32.01.pa
	33	6	6	9.5	m30d33.01.pa		33	8	6.4	9.5	m40d33.01.pa
	34	6	6	9.5	m30d34.01.pa		34	8	6.4	9.5	m40d34.01.pa
	35	6	6	9.5	m30d35.01.pa		35	8	6.4	9.5	m40d35.01.pa
	36	6	6	9.5	m30d36.01.pa		36	8	6.4	9.5	m40d36.01.pa

Andere Abmessungen auf Anfrage

Autres dimensions sur demande

Further dimensions on request

Isolier Distanz-Bolzen Kunststoff

Entretoises hexagon. isol.

Insulating spacers

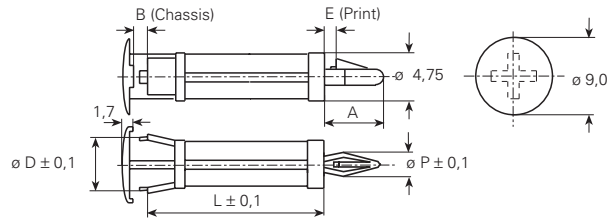

Werkstoff:
pa = Polyamid, schwarz

Matière:
pa = polyamide, noire

Material:
pa = polyamid, black

Temperaturbeständigkeit:
-40°C bis +110°C

Résistant à une température de:
-40°C à +110°C

Temperature range:
-40°C up to +110°C

einschnappbar mit Kopf / encliquante avec tête / snap in form with head

B mm	L mm	øD mm	A mm	E mm	P mm	Artikelnummer Numéro d'article Part-No.	B mm	L mm	øD mm	A mm	E mm	P mm	Artikelnummer Numéro d'article Part-No.	
1	5	5	10.5	0.6	4	ah16e050.pa		16	5	9.9	1.5	3.2	ah2e160.pa	
	7	5	10.5	0.6	4	ah16e070.pa		17	5	9.9	1.5	3.2	ah2e170.pa	
	8	5	10.5	0.6	4	ah16e080.pa		18	5	9.9	1.5	3.2	ah2e180.pa	
	9.5	5	10.5	0.6	4	ah16e095.pa		19	5	9.9	1.5	3.2	ah2e190.pa	
	12	5	10.5	0.6	4	ah16e120.pa		20	5	9.9	1.5	3.2	ah2e200.pa	
	13	5	10.5	0.6	4	ah16e130.pa		3	3.2	5	9.9	1.5	3.2	ah3e032.pa
	15	5	10.5	0.6	4	ah16e150.pa			4	5	9.9	1.5	3.2	ah3e040.pa
	17	5	10.5	0.6	4	ah16e170.pa			5	5	9.9	1.5	3.2	ah3e050.pa
	25	5	10.5	0.6	4	ah16e250.pa			6	5	9.9	1.5	3.2	ah3e060.pa
	27	5	10.5	0.6	4	ah16e270.pa			7	5	9.9	1.5	3.2	ah3e070.pa
2	3.2	5	9.9	1.5	3.2	ah2e032.pa	8		5	9.9	1.5	3.2	ah3e080.pa	
	4	5	9.9	1.5	3.2	ah2e040.pa	9		5	9.9	1.5	3.2	ah3e090.pa	
	5	5	9.9	1.5	3.2	ah2e050.pa	10	5	9.9	1.5	3.2	ah3e100.pa		
	6	5	9.9	1.5	3.2	ah2e060.pa	11	5	9.9	1.5	3.2	ah3e110.pa		
	7	5	9.9	1.5	3.2	ah2e070.pa	12	5	9.9	1.5	3.2	ah3e120.pa		
	8	5	9.9	1.5	3.2	ah2e080.pa	13	5	9.9	1.5	3.2	ah3e130.pa		
	9	5	9.9	1.5	3.2	ah2e090.pa	14	5	9.9	1.5	3.2	ah3e140.pa		
	10	5	9.9	1.5	3.2	ah2e100.pa	15	5	9.9	1.5	3.2	ah3e150.pa		
	11	5	9.9	1.5	3.2	ah2e110.pa	16	5	9.9	1.5	3.2	ah3e160.pa		
	12	5	9.9	1.5	3.2	ah2e120.pa	17	5	9.9	1.5	3.2	ah3e170.pa		
13	5	9.9	1.5	3.2	ah2e130.pa	18	5	9.9	1.5	3.2	ah3e180.pa			
14	5	9.9	1.5	3.2	ah2e140.pa	19	5	9.9	1.5	3.2	ah3e190.pa			
15	5	9.9	1.5	3.2	ah2e150.pa	20	5	9.9	1.5	3.2	ah3e200.pa			

Andere Abmessungen auf Anfrage

Autres dimensions sur demande

Further dimensions on request

Isolier Distanz-Bolzen Kunststoff Entretôises hexagon. isol. Insulating spacers

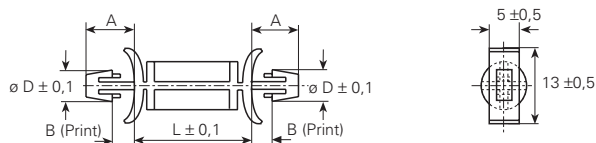

Werkstoff:
pa = Polyamid, schwarz

Matière:
pa = polyamide, noire

Material:
pa = polyamid, black

Temperaturbeständigkeit:
-40°C bis +110°C

Résistant à une température de:
-40°C à +110°C

Temperature range:
-40°C up to +110°C

beidseitig einschnappbar / encliquante des deux côtés / snap-in

B mm	L mm	øD mm	A mm	Artikelnummer Numéro d'article Part-No.	B mm	L mm	øD mm	A mm	Artikelnummer Numéro d'article Part-No.
1.5-2.6	8.5	4.75	7.8	ah15e085.pa		8.5	4	7.8	ah1e085.pa
	12	4.75	7.8	ah15e120.pa		12	4	7.8	ah1e120.pa
	15.1	4.75	7.8	ah15e151.pa		15.1	4	7.8	ah1e151.pa
	18.3	4.75	7.8	ah15e183.pa		18.3	4	7.8	ah1e183.pa
	21.5	4.75	7.8	ah15e215.pa		21.5	4	7.8	ah1e215.pa
	24.5	4.75	7.8	ah15e245.pa		24.5	4	7.8	ah1e245.pa

Andere Abmessungen auf Anfrage

Autres dimensions sur demande

Further dimensions on request

Isolier Distanz-Bolzen / Ziermuttern / Zierschrauben Entretoises hexagon. isol. / Bouchons écrou / Bouchons vis Insulating spacers / Cap nuts / Cap bolts

mit Innen- und Aussengewinde aus Metall

Werkstoff:

ps = Kunststoffmantel aus Polystyrol grau
Aussengewindebolzen aus Stahl verzinkt
Innengewindebüchse aus Messing blank

Temperaturbeständigkeit:
-40°C bis +70°C

avec filet métallique femelle et mâle

Matière:

ps = Partie isolée en polystyrène gris
Tige filetée en acier zingué
Filet intérieur en laiton brut

Résistant à une température de:
-40°C à +70°C

with internal and external metal thread

Material:

ps = Plastic part of grey polystyrene
Threaded-end of zinc-plated steel
Threaded-bush of yellow brass clean

Temperature range:
-40°C up to +70°C

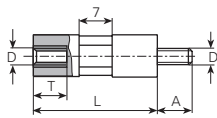

øD mm	L mm	SW mm	T mm	A mm	Artikelnummer Numéro d'article Part-No.
M3	15	6	7	7	m30015.01.ps
	20	6	7	7	m30020.01.ps
	25	6	7	7	m30025.01.ps
	30	6	7	7	m30030.01.ps
	40	6	7	7	m30040.01.ps
	55	6	7	7	m30055.01.ps

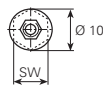
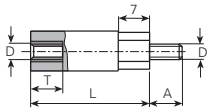

øD mm	L mm	SW mm	T mm	A mm	Artikelnummer Numéro d'article Part-No.
M4	10	9	3.5	7	m40010.01.ps
	12	9	3.5	7	m40012.01.ps
	14	9	3.5	7	m40014.01.ps
	16	9	7	7	m40016.01.ps
	18	9	7	7	m40018.01.ps
	22	9	7	7	m40022.01.ps
	24	9	7	7	m40024.01.ps
	28	9	7	7	m40028.01.ps
	32	9	7	7	m40032.01.ps
	35	9	7	7	m40035.01.ps
	38	9	7	7	m40038.01.ps
	45	9	7	7	m40045.01.ps
	50	9	7	7	m40050.01.ps
	56	9	7	7	m40056.01.ps
	62	9	7	7	m40062.01.ps
	65	9	7	7	m40065.01.ps
	70	9	7	7	m40070.01.ps
	75	9	7	7	m40075.01.ps
80	9	7	7	m40080.01.ps	
85	9	7	7	m40085.01.ps	

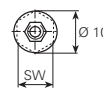
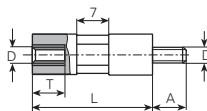

øD mm	L mm	SW mm	T mm	A mm	Artikelnummer Numéro d'article Part-No.
M4	15	9	7	7	m40015.01.ps
	20	9	7	7	m40020.01.ps
	25	9	7	7	m40025.01.ps
	30	9	7	7	m40030.01.ps
	40	9	7	7	m40040.01.ps
	55	9	7	7	m40055.01.ps
	60	9	7	7	m40060.01.ps
	90	9	7	7	m40090.01.ps

Andere Abmessungen auf Anfrage

Autres dimensions sur demande

Further dimensions on request



Verbindungstechnik

Isolier Distanz-Bolzen / Ziermuttern / Zierschrauben Entretoises hexagon. isol. / Bouchons écrou / Bouchons vis Insulating spacers / Cap nuts / Cap bolts

mit Innen- und Aussengewinde aus Metall

Werkstoff:

ps = Kunststoffmantel aus Polystyrol grau
Aussengewindebolzen aus Stahl verzinkt
Innengewindebüchse aus Messing blank

Temperaturbeständigkeit:
-40°C bis +70°C

avec filet métallique femelle et mâle

Matière:

ps = Partie isolée en polystyrène gris
Tige filetée en acier zingué
Filet intérieur en laiton brut

Résistant à une température de:
-40°C à +70°C

with internal and external metal thread

Material:

ps = Plastic part of grey polystyrene
Threaded-end of zinc-plated steel
Threaded-bush of yellow brass clean

Temperature range:
-40°C up to +70°C

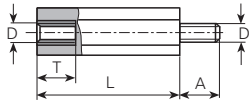

øD mm	L mm	SW mm	T mm	A mm	Artikelnummer Numéro d'article Part-No.
M5	15	13	7	7	m50015.01.ps
	20	13	7	7	m50020.01.ps
	25	13	7	7	m50025.01.ps
	30	13	7	7	m50030.01.ps
	35	13	7	7	m50035.01.ps
	40	13	7	7	m50040.01.ps
	45	13	7	7	m50045.01.ps
	50	13	7	7	m50050.01.ps
	55	13	7	7	m50055.01.ps
	60	13	7	7	m50060.01.ps
	65	13	7	7	m50065.01.ps
	70	13	7	7	m50070.01.ps
	75	13	7	7	m50075.01.ps
	80	13	7	7	m50080.01.ps
	85	13	7	7	m50085.01.ps
	90	13	7	7	m50090.01.ps
100	13	7	7	m50100.01.ps	
110	13	7	7	m50110.01.ps	
120	13	7	7	m50120.01.ps	
M6	15	13	8	7	m60015.01.ps
	20	13	8	7	m60020.01.ps
	25	13	8	7	m60025.01.ps
	30	13	8	7	m60030.01.ps
	35	13	8	7	m60035.01.ps
	40	13	8	7	m60040.01.ps
	45	13	8	7	m60045.01.ps
	50	13	8	7	m60050.01.ps
	55	13	8	7	m60055.01.ps
	60	13	8	7	m60060.01.ps
	65	13	8	7	m60065.01.ps
	70	13	8	7	m60070.01.ps
	75	13	8	7	m60075.01.ps
	80	13	8	7	m60080.01.ps
	85	13	8	7	m60085.01.ps
	90	13	8	7	m60090.01.ps
100	13	8	7	m60100.01.ps	
110	13	8	7	m60110.01.ps	
120	13	8	7	m60120.01.ps	

Andere Abmessungen auf Anfrage

Autres dimensions sur demande

Further dimensions on request

Isolier Distanz-Bolzen / Ziermuttern / Zierschrauben Entretroises hexagon. isol. / Bouchons écrou / Bouchons vis Insulating spacers / Cap nuts / Cap bolts

mit durchgehendem Gewindebolzen Stahl verzinkt

Werkstoff:
ps = Kunststoffmantel aus Polystyrol grau
Durchgehender Gewindebolzen aus Stahl verzinkt

Temperaturbeständigkeit:
-40°C bis +70°C

avec tige filetée totalement en acier zingué

Matière:
ps = Partie isolée en polystyrène gris
Tige filetée totalement en acier zingué

Résistant à une température de:
-40°C à +70°C

with threaded-end rod of zinc-plated steel

Material:
ps = Plastic part of grey polystyrene
Threaded-end rod of zinc-plated steel

Temperature range:
-40°C up to +70°C

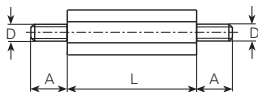

øD mm	L mm	SW mm	A mm	Artikelnummer Numéro d'article Part-No.
M6	45	9	10	m60045.11.ps
	50	9	10	m60050.11.ps
	60	9	10	m60060.11.ps
	70	9	10	m60070.11.ps
	85	9	10	m60085.11.ps
	100	9	10	m60100.11.ps
	110	9	10	m60110.11.ps
	120	9	10	m60120.11.ps
	140	9	10	m60140.11.ps
	180	9	10	m60180.11.ps

Andere Abmessungen auf Anfrage

Autres dimensions sur demande

Further dimensions on request

Isolier Distanz-Bolzen / Ziermuttern / Zierschrauben Entretoises hexagon. isol. / Bouchons écrou / Bouchons vis Insulating spacers / Cap nuts / Cap bolts

mit Innengewinde aus Messing blank

Werkstoff:
ps = Kunststoffmantel aus Polystyrol grau

Temperaturbeständigkeit:
-40°C bis +70°C

avec filet femelle en laiton brut

Matière:
ps = Partie isolée en polystyrène gris

Résistant à une température de:
-40°C à +70°C

with internal thread of brass clean

Material:
ps = Plastic part of grey polystyrene

Temperature range:
-40°C up to +70°C

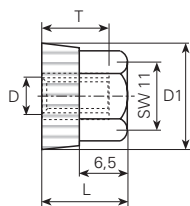

øD mm	L mm	øD1 mm	T mm	Artikelnummer Numéro d'article Part-No.
M4	12 ±1	14	8 ±1	m40.0.ps
M5	12 ±1	14	8 ±1	m50.0.ps
M6	12 ±1	14	8 ±1	m60.0.ps

Andere Abmessungen auf Anfrage

Autres dimensions sur demande

Further dimensions on request

mit Innengewinde aus Stahl verzinkt unverlierbar

Werkstoff:
ps = Kunststoffmantel aus Polystyrol grau

Temperaturbeständigkeit:
-40°C bis +70°C

avec filet femelle en acier zingué imperdable

Matière:
ps = Partie isolée en polystyrène gris

Résistant à une température de:
-40°C à +70°C

with internal thread of yellow zinc-plated steel captive

Material:
ps = Plastic part of grey polystyrene

Temperature range:
-40°C up to +70°C

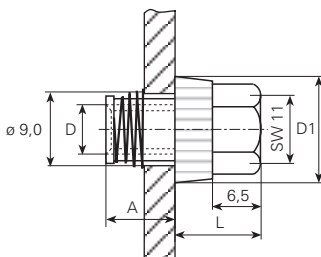

øD mm	L mm	øD1 mm	A mm	Artikelnummer Numéro d'article Part-No.
M6	12 ±1	14	10 ±1	m60.10.ps

Andere Abmessungen auf Anfrage

Autres dimensions sur demande

Further dimensions on request

Zierschraube mit Aussengewinde aus Stahl verzinkt

Werkstoff:
ps = Kunststoffmantel aus Polystyrol grau

Temperaturbeständigkeit:
-40°C bis +70°C

Bouchons vis avec filet mâle en acier zingué

Matière:
ps = Partie isolée en polystyrène gris

Résistant à une température de:
-40°C à +70°C

cap bolt with external thread of zinc-plated steel

Material:
ps = Plastic part of grey polystyrene

Temperature range:
-40°C up to +70°C

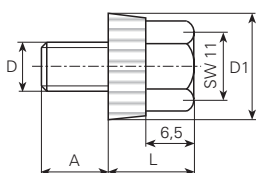

øD mm	L mm	øD1 mm	A mm	Artikelnummer Numéro d'article Part-No.
M4	12 ±1	14	8 ±1	m40.1.ps
M5	12 ±1	14	8 ±1	m50.1.ps
M6	12 ±1	14	8 ±1	m60.1.ps

Andere Abmessungen auf Anfrage

Autres dimensions sur demande

Further dimensions on request

Werkstoff/Matière/Material
.4 = Kupfer/cuivre/copper
.6 = Messing/laiton/brass

■ = Oberflächen/Surface/Surface-plating
Seite/page/page 5.011

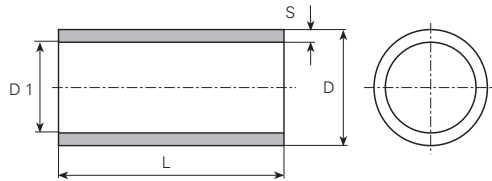

øD mm	S mm	L mm	øD1 mm	Artikelnummer Numéro d'article Part-No.	øD mm	S mm	L mm	øD1 mm	Artikelnummer Numéro d'article Part-No.	øD mm	S mm	L mm	øD1 mm	Artikelnummer Numéro d'article Part-No.	
1	0.2	20	0.6	x10200020.6		0.54	4	2.96	x40040054.4	5.34	0.47	9	4.4	x53090047.4	
2.1	0.3	3.5	1.5	x21035030.4		0.54	4.5	2.96	x40045054.4	5.4	0.42	10	4.56	x54100042.4	
3	0.30	17	2.4	x30170030.4		0.54	6	2.96	x40060054.4		0.5	10.2	4.4	x54102050.4	
3.2	0.3	2.9	2.6	x32029030.4		0.54	7	2.96	x40070054.4	5.43	0.37	10.2	4.69	x54102037.4	
	0.3	12	2.6	x32120030.4		0.54	10	2.96	x40100054.4	5.5	0.25	13	5	x55130025.6	
	0.31	9.5	2.58	x32095031.4		0.54	13	2.96	x40130054.4	5.6	0.4	6.5	4.8	x56065040.4	
	0.34	7.8	2.52	x32078034.4		0.74	4.5	2.56	x40045074.4	5.89	0.64	4	4.61	x59040064.4	
	0.49	4.8	2.22	x32048049.4		0.74	5.5	2.56	x40055074.4		0.64	6	4.61	x59060064.4	
	0.49	7.8	2.22	x32078049.4		0.74	7	2.56	x40070074.4		0.64	7	4.61	x59070064.4	
	0.49	12	2.22	x32120050.4		4.2	0.29	7	3.62	x42070029.4	5.9	0.55	7	4.8	x59070055.6
	0.5	7	2.2	x32070050.4		0.47	9	3.26	x42090047.4		0.65	10	4.6	x59100065.4	
0.5	9	2.2	x32090050.4		4.25	0.3	10	3.65	x42100030.4	6	0.34	9	5.32	x60090034.4	
3.6	0.33	5.5	2.94	x36055033.4		0.32	7	3.61	x42070032.4		0.39	18	5.22	x60180039.4	
	0.33	7	2.94	x36070033.4		4.3	0.35	7.8	3.6	x43078035.4	6.1	0.45	7	5.2	x61070045.4
	0.33	9	2.94	x36090033.4			0.35	9	3.6	x43090035.4		0.45	10.5	5.2	x61105045.4
0.33	10	2.94	x36100033.4		0.35		10.5	3.6	x43105035.4		0.45	13.5	5.2	x61135045.4	
3.61	0.26	3	3.09	x36030026.4		0.46	11	3.38	x43110046.4		0.45	15	5.2	x61150045.4	
	0.26	9.5	3.09	x36095026.4		4.4	0.2	9	4	x44090020.4	6.2	0.47	8	5.26	x62080047.4
3.8	0.3	5.2	3.2	x38052030.6		4.44	0.48	6.3	3.48	x44063048.6		0.52	7.6	5.16	x62076052.6
	0.3	6.3	3.2	x38063030.6		4.5	0.3	7	3.9	x45070030.6		0.56	9	5.08	x62090056.4
	0.3	8	3.2	x38080030.4			0.45	6	3.6	x45060045.4		0.56	12	5.08	x62120056.4
	0.33	8	3.14	x38080033.4			0.45	7	3.6	x45070045.4		0.62	9	4.96	x62090062.4
	0.33	9	3.14	x38090033.4			0.47	9	3.56	x45090047.4		0.65	9	4.9	x62090065.4
	0.43	11	2.94	x38110043.4			0.47	10.7	3.56	x45107047.4		0.65	11	4.9	x62110065.4
					0.5		9	3.5	x45090050.4		0.65	12	4.9	x62120065.4	
3.84	0.47	9	2.9	x38090047.4		0.5	9	3.5	x45090050.6		0.65	12	4.9	x62120065.4	
3.85	0.31	7.8	3.23	x38078031.4		0.5	9	3.5	x45090050.4		0.7	9	4.8	x62090070.4	
	0.31	9	3.23	x38090031.4		0.5	12	3.5	x45120050.4	6.3	0.49	10.5	5.32	x63105049.4	
3.86	0.33	5	3.20	x38050033.4		4.59	0.5	9	3.59	x46090050.4	6.32	0.56	10.5	5.2	x63105056.4
3.88	0.28	10	3.32	x38100028.4		4.6	0.36	6.3	3.88	x46063036.6	6.33	0.41	13.5	5.51	x63135041.4
3.9	0.2	8	3.5	x39080020.4		4.7	0.38	9	3.94	x47090038.4	6.35	0.45	10.15	5.45	x63101045.4
3.92	0.29	9	3.34	x39090029.4		5	0.25	9	4.5	x50090025.6	6.38	0.4	6	5.58	x64060040.4
3.94	0.41	12.8	3.12	x39128041.6		0.34	10.5	4.32	x50105034.4	0.4		9.5	5.58	x64095040.4	
4	0.35	7	3.3	x40070035.4		0.4	10.5	4.2	x50105040.4	0.4		12	5.58	x63120040.4	
	0.35	9	3.3	x40090035.4		0.42	7	4.16	x50070042.4	0.43		12.7	5.52	x63127043.4	
	0.37	13	3.26	x40130037.4		0.42	9	4.16	x50090042.4	6.4	0.42	12	5.56	x64120042.4	
	0.4	6.3	3.20	x40063040.4		0.42	10	4.16	x50100042.4		0.5	8	5.4	x64080050.4	
	0.55	7	2.9	x40070055.4		0.42	10	4.16	x50100042.4		0.5	9.5	5.4	x64095050.4	
	0.7	5.5	2.6	x40055070.4		0.5	11	4	x50110050.4		0.5	12	5.4	x64120050.4	
0.7	7	2.6	x40070070.4		5.08	0.48	9	4.12	x51090048.4		0.5	12	5.4	x64120050.4	
					5.1	0.5	12	4.1	x51120050.4		0.5	13.5	5.4	x64135050.4	
4.03	0.73	10	2.57	x40100073.4		5.12	0.42	9	4.28	x51090042.4	6.45	0.47	6.3	5.51	x64063050.6
4.04	0.34	5.5	3.36	x40055034.4			0.42	10	4.28	x51100042.4	6.5	0.4	6.5	5.7	x65065040.4
	0.34	7	3.36	x40070034.4			0.42	11	4.28	x51110042.4	6.54	0.41	13.5	5.72	x65135041.4
	0.34	10	3.36	x40100034.4		5.2	0.35	6.3	4.5	x52063035.6		0.54	4	5.46	x65040054.4
	0.36	12.8	3.32	x40128036.6			0.52	9	4.16	x52090052.4		0.54	6	5.46	x65060054.4
	0.46	7	3.12	x40070046.4		5.21	0.66	9	3.89	x52090066.4		0.54	6.5	5.46	x65065054.4
	0.46	8.2	3.12	x40082046.4		5.3	0.39	10.5	4.52	x53105039.4		0.54	10	5.46	x65100054.4
	0.46	10	3.12	x40100046.4			0.55	9	4.2	x53090055.4		0.54	13.5	5.46	x65135054.4

Andere Abmessungen auf Anfrage

Autres dimensions sur demande

Further dimensions on request

Crimphülsen Douilles à sertir Crimping sleeves

Werkstoff/Matière/ Material
.4 = Kupfer/cuivre/copper
.6 = Messing/laiton/brass

■ = Oberflächen/Surface/Surface-plating
Seite/page/page 5.011

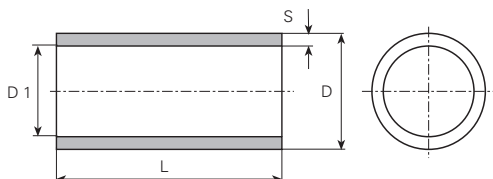

øD mm	S mm	L mm	øD1 mm	Artikelnummer Numéro d'article Part-No.	øD mm	S mm	L mm	øD1 mm	Artikelnummer Numéro d'article Part-No.	øD mm	S mm	L mm	øD1 mm	Artikelnummer Numéro d'article Part-No.
	0.54	16	5.46	x65160054.4 ■	8.15	0.55	12.7	7.05	x81127055.4 ■	10.65	0.63	17.5	9.39	x1061750634 ■
6.6	0.37	13.5	5.86	x66135037.6 ■	8.4	0.55	7	7.3	x84070055.6 ■		0.63	23	9.39	x1062300634 ■
6.63	0.42	13.5	5.79	x66135042.4 ■	8.5	0.4	12	7.7	x85120040.4 ■	11	0.5	25	10	x1102500504 ■
7	0.25	2.5	6.5	x70025025.4 ■	9	0.7	9	7.6	x90090070.6 ■	11.02	0.51	7	10	x1100700516 ■
7.5	0.47	9.5	6.56	x75095047.6 ■	9.35	0.7	12	7.95	x93120070.4 ■	11.05	0.5	15.3	10.05	x1101530504 ■
	0.6	9	6.3	x75090060.4 ■	9.4	0.6	12	8.2	x94120060.4 ■	11.5	0.5	9	10.5	x1150900504 ■
7.64	0.62	7	6.4	x76070062.4 ■	9.5	0.35	12	8.8	x95120035.4 ■	12.02	0.45	7.1	11.12	x1200710456 ■
	0.62	11	6.4	x76110062.4 ■		0.72	4	8.06	x95040072.4 ■		0.51	7	11	x1200700516 ■
	0.62	13.5	6.4	x76135062.4 ■	9.55	0.6	13.5	8.35	x95135060.4 ■	12.25	0.65	15.5	10.95	x1221550654 ■
7.78	0.44	12	6.9	x78120044.4 ■		0.72	13.5	8.11	x95135072.4 ■	12.3	0.45	15.5	11.4	x1231550454 ■
	0.63	12	6.52	x78120063.4 ■	9.8	0.58	13.5	8.64	x98135058.4 ■		0.5	25	11.3	x1232500504 ■
7.84	0.44	13.5	6.96	x78135044.4 ■		0.58	17	8.64	x98170058.4 ■	12.44	0.49	15.5	11.46	x1241550496 ■
7.9	0.5	12	6.9	x79120050.4 ■	10.1	0.45	13.5	9.2	x1011350454 ■	12.5	0.9	15.5	10.7	x1251550904 ■
	0.52	12	6.86	x79120052.4 ■	10.14	0.49	13.5	9.16	x1011350494 ■	12.56	0.71	15.5	11.14	x1251550714 ■
8	0.5	12	7	x80120050.4 ■	10.34	0.45	9.5	9.44	x1030950456 ■	14.5	0.67	22	13.16	x1452200674 ■

Andere Abmessungen auf Anfrage

Autres dimensions sur demande

Further dimensions on request

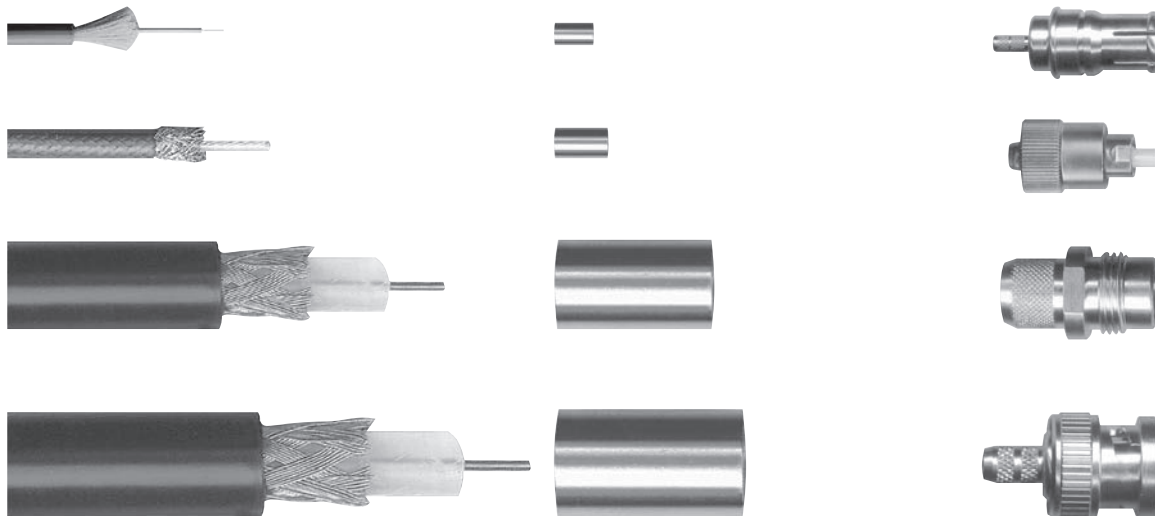

Werkstoff/Matière/Material
 .1 = Aluminium
 .4 = Kupfer/cuivre/copper
 .6 = Messing/laiton/brass
 .9 = Stahl/acier/steel

■ = Oberflächen/Surface/Surface-plating
 Seite/page/page 5.011

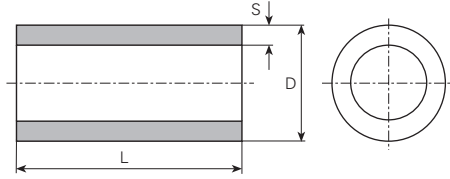

für Bolzen pour borne for stud mm	øD mm	S mm	L mm	Artikelnummer Numéro d'article Part-No.	für Bolzen pour borne for stud mm	øD mm	S mm	L mm	Artikelnummer Numéro d'article Part-No.	für Bolzen pour borne for stud mm	øD mm	S mm	L mm	Artikelnummer Numéro d'article Part-No.	
M2	2.8	0.2	4	x28040020.6■	4.5	4.5	0.9	2	x45020090.10	5	5	0.75	4.5	x50045075.6■	
	3	0.3	2	x30020030.10		4.5	0.9	2.5	x45025090.10		5	1	4.5	x50045100.9■	
	3	0.4	2.1	x30021040.6■		4.5	0.9	3	x45030090.10		5	0.75	5	x50050075.10	
	3	0.3	2.5	x30025030.6■		4.5	0.9	3.5	x45035090.10		5	0.75	5	x50050075.6■	
	3	0.3	3	x30030030.6■		4.5	0.9	4	x45040090.10		5	0.75	5	x50050075.9■	
	3	0.3	3	x30030030.9■		4.5	0.9	4.4	x45044090.10		5	1	5	x50050100.6■	
	3	0.5	3	x30030050.10		4.5	0.9	4.5	x45045090.10		5	0.75	5.5	x50055075.10	
	3	0.3	4	x30040030.10		4.5	0.9	5	x45050090.10		5	0.75	6	x50060075.10	
	3	0.3	5	x30050030.10		4.5	0.9	5	x45050090.9■		5	0.75	6	x50060075.9■	
	3	0.4	5	x30050040.6■		4.5	0.9	6	x45060090.10		5	0.75	6.4	x50064075.6■	
	3	0.5	5	x30050050.6■		4.5	0.9	7	x45070090.10		5	0.75	6.5	x50065075.10	
	3	0.3	6	x30060030.6■		4.5	0.9	7.3	x45073090.10		5	0.75	7	x50070075.10	
	3	0.3	7	x30070030.9■		4.5	0.9	8	x45080090.10		5	0.75	7	x50070075.6■	
	3	0.5	13	x30130050.6■		4.5	0.9	9	x45090090.10		5	0.75	7.2	x50072075.10	
	3	0.5	13	x30130050.9■		4.5	0.9	10	x45100090.10		5	0.75	8	x50080075.10	
	3	0.3	20	x30200030.9■		4.5	0.9	10.5	x45105090.10		5	0.75	8	x50080075.6■	
	3	0.5	20	x30200050.9■		4.5	0.9	11	x45110090.10		5	0.75	8	x50080075.9■	
	4	0.8	1	x40010080.10		4.5	0.9	12	x45120090.10		5	0.75	8.5	x50085075.6■	
	4	0.8	2	x40020080.10		4.5	0.9	13.5	x45135090.10		5	0.75	9	x50090075.10	
	4	0.75	2.5	x40025075.6■		4.5	0.9	14	x45140090.10		5	0.75	9	x50090075.9■	
	4	0.8	3	x40030080.10		4.5	0.9	15	x45150090.10		5	0.75	9.3	x50093075.6■	
	4	0.8	4	x40040080.10		4.5	0.9	16	x45160090.10		5	0.75	9.4	x50094075.6■	
	4	0.75	5	x40050075.6■		4.5	0.9	20	x45200090.10		5	0.75	9.5	x50095075.10	
	4	0.8	5	x40050080.10		M3	4	0.4	4		x40040040.10	5	0.75	9.6	x50096075.6■
	4	0.8	5.3	x40053080.10			5	0.75	10		x40080040.10	5	0.75	10	x50100075.10
	4	0.8	5.5	x40055080.10			5	0.75	10		x40120040.10	5	0.75	10	x50100075.6■
	4	0.8	6	x40060080.10			5	0.75	10		x40120040.6■	5	0.75	10	x50100075.9■
4	0.8	7	x40070080.10	5	0.75		11	x40280040.6■	5	0.75	11	x50110075.10			
4	0.8	8	x40080080.10	4.5	0.5		3	x45030050.6■	5	0.75	11	x50110075.6■			
4	0.8	9	x40090080.10	4.8	0.5		3	x48030050.6■	5	0.75	11	x50110075.9■			
4	0.8	10	x40100080.10	5	0.75		2	x50020075.10	5	0.75	11.5	x50115075.10			
4	0.8	12	x40120080.10	5	0.75		2	x50020075.6■	5	0.75	12	x50120075.10			
4	0.8	15	x40150080.10	5	0.75		2	x50020075.9■	5	0.75	12	x50120075.6■			
4	0.8	16	x40160080.10	5	0.75		2.2	x50022075.10	5	0.75	12	x50120075.9■			
4	0.8	20	x40200080.10	5	0.75		2.5	x50025075.10	5	0.75	13	x50130075.10			
4	0.8	30	x40300080.10	5	0.75		2.5	x50025075.9■	5	0.75	13	x50130075.9■			
4.5	0.9	2.2	x45022090.10	5	0.75		3	x50030075.10	5	0.75	14	x50140075.10			
4.5	0.9	6.5	x45065090.10	5	0.75		3	x50030075.6■	5	0.75	14	x50140075.9■			
M2.5	4	0.5	1.9	x40019050.6■	5		0.75	3	x50030075.9■	5	0.75	15	x50150075.10		
	4	0.5	3	x40030050.6■	5		0.75	3.5	x50035075.10	5	0.75	16	x50160075.10		
	4	0.5	4	x40040050.10	5		0.75	3.7	x50037075.10	5	0.75	16	x50160075.9■		
	4	0.5	4	x40040050.6■	5		0.75	4	x50040075.10	5	0.75	17	x50170075.10		
	4	0.5	9	x40090050.6■	5		0.75	4	x50040075.9■	5	0.75	17	x50170075.9■		
	4	0.5	12	x40120050.6■	5		0.9	4	x50040090.6■	5	0.75	18	x50180075.10		
	4	0.5	18.6	x40186050.6■	5	0.75	4.1	x50041075.6■	5	0.75	18	x50180075.9■			

Andere Abmessungen auf Anfrage

Autres dimensions sur demande

Further dimensions on request

für Bolzen pour borne for stud mm	øD mm	S mm	L mm	Artikelnummer Numéro d'article Part-No.	für Bolzen pour borne for stud mm	øD mm	S mm	L mm	Artikelnummer Numéro d'article Part-No.	für Bolzen pour borne for stud mm	øD mm	S mm	L mm	Artikelnummer Numéro d'article Part-No.
5	0.75	20		x50200075.10		5.5	1.1	24	x55240110.10		6	0.9	9	x60090090.10
5	0.75	22		x50220075.10		5.5	1.1	25	x55250110.10		6	0.75	10	x60100075.9
5	0.75	23		x50230075.10		5.5	1.1	26.8	x55268110.10		6	0.9	10	x60100090.10
5	0.75	23		x50230075.6		5.5	1.1	27.5	x55275110.10		6	0.75	11	x60110075.9
5	0.75	24		x50240075.10		5.5	1.1	30	x55300110.10		6	0.9	11	x60110090.10
5	0.75	24		x50240075.9		5.5	1.1	32	x55320110.10		6	1	11	x60110100.6
5	0.75	25		x50250075.10		5.5	1.1	38	x55380110.10		6	0.9	11.7	x60117090.10
5	0.75	26.5		x50265075.10		5.5	1.1	40	x55400110.10		6	0.75	12	x60120075.6
5	0.75	30		x50300075.10		5.5	1.1	85	x55850110.10		6	0.75	12	x60120075.9
5	0.75	35		x50350075.10		5.6	1	15	x56150100.4		6	0.9	12	x60120090.10
5	0.75	40		x50400075.10		6	1.45	5	x60050145.10		6	0.75	13	x60130075.9
5	0.75	43		x50430075.10	M4	4.8	0.4	6	x48060040.6		6	0.75	14	x60140075.9
5	0.75	50		x50500075.10		5	0.35	3	x50030035.6		6	0.9	14	x60140090.10
5.5	1.1	1		x55010110.10		5	0.35	30	x50300035.10		6	0.75	15	x60150075.9
5.5	1.1	1.5		x55015110.10		5	0.45	4	x50040045.6		6	0.9	15	x60150090.10
5.5	1.1	2		x55020110.10		5	0.5	4	x50040050.6		6	1	15.5	x60155100.6
5.5	1.1	2.5		x55025110.10		5	0.5	6	x50060050.10		6	0.75	16	x60160075.9
5.5	1.1	3		x55030110.10		5	0.5	10	x50100050.10		6	0.9	16	x60160090.10
5.5	1.1	3.5		x55035110.10		5	0.5	14	x50140050.10		6	0.9	17	x60170090.10
5.5	1.1	4		x55040110.10		5	0.5	26	x50260050.10		6	0.75	18	x60180075.6
5.5	1.1	4.2		x55042110.10		5	0.5	30	x50300050.9		6	0.75	18	x60180075.9
5.5	1.1	4.5		x55045110.10		6	0.75	2	x60020075.9		6	0.9	18	x60180090.10
5.5	1.1	4.6		x55046110.10		6	0.9	1.5	x60015090.10		6	0.9	19	x60190090.10
5.5	1.1	4.7		x55047110.10		6	0.9	2	x60020090.10		6	0.75	20	x60200075.9
5.5	1.1	5		x55050110.10		6	0.9	2.5	x60025090.10		6	0.9	20	x60200090.10
5.5	1.1	5.3		x55053110.10		6	0.9	2.6	x60026090.10		6	0.75	22	x60220075.9
5.5	1.1	5.5		x55055110.10		6	1	2.5	x60025100.6		6	0.9	23	x60230090.10
5.5	1.1	5.7		x55057110.10		6	0.75	3	x60030075.9		6	0.75	24	x60240075.9
5.5	1.1	6		x55060110.10		6	0.9	3	x60030090.10		6	0.9	25	x60250090.10
5.5	1.1	6.4		x55064110.10		6	1	3	x60030100.6		6	0.75	26	x60260075.9
5.5	1.1	6.5		x55065110.10		6	0.9	3.5	x60035090.10		6	0.75	28	x60280075.9
5.5	1.1	6.6		x55066110.10		6	1	3.5	x60035100.6		6	0.9	28	x60280090.10
5.5	1.1	7		x55070110.10		6	1	3.5	x60035100.9		6	0.75	30	x60300075.9
5.5	1.1	7.5		x55075110.10		6	0.75	4	x60040075.6		6	0.9	30	x60300090.10
5.5	1.1	8		x55080110.10		6	0.75	4	x60040075.9		6	0.75	32	x60320075.9
5.5	1.1	8.6		x55086110.10		6	0.9	4	x60040090.10		6	0.75	35	x60350075.9
5.5	1.1	9		x55090110.10		6	1	4	x60040100.6		6	0.9	35	x60350090.10
5.5	1.1	9.5		x55095110.10		6	0.9	4.5	x60045090.10		6	0.9	37	x60370090.10
5.5	1.1	10		x55100110.10		6	1	4.5	x60045100.6		6	0.75	38	x60380075.9
5.5	1.1	10.5		x55105110.10		6	1	4.5	x60045100.9		6	0.9	40	x60400090.10
5.5	1.1	10.7		x55107110.10		6	0.75	5	x60050075.9		6	0.75	50	x60500075.9
5.5	1.1	11		x55110110.10		6	0.9	5	x60050090.10		7	1.35	2	x70020135.10
5.5	1.1	11.5		x55115110.10		6	1	5	x60050100.6		7	1.35	2.5	x70025135.10
5.5	1.1	11.6		x55116110.10		6	0.9	5.3	x60053090.10		7	1.4	3	x70030140.10
5.5	1.1	12		x55120110.10		6	0.9	5.5	x60055090.10		7	1.35	3.5	x70035135.10
5.5	1.1	12.5		x55125110.10		6	1	5.5	x60055100.9		7	1.4	4	x70040140.10
5.5	1.1	13		x55130110.10		6	0.75	6	x60060075.9		7	1.4	5	x70050140.10
5.5	1.1	13.5		x55135110.10		6	0.9	6	x60060090.10		7	1.35	5.2	x70052135.10
5.5	1.1	14		x55140110.10		6	1	6	x60060100.6		7	1.4	6	x70060140.10
5.5	1.1	15		x55150110.10		6	0.9	6.5	x60065090.10		7	1.4	7	x70070140.10
5.5	1.1	16		x55160110.10		6	0.75	7	x60070075.9		7	1.4	7.2	x70072140.10
5.5	1.1	18		x55180110.10		6	0.9	7	x60070090.10		7	1.4	8	x70080140.10
5.5	1.1	19		x55190110.10		6	0.75	8	x60080075.9		7	1.35	8.5	x70085135.10
5.5	1.1	20		x55200110.10		6	0.9	8	x60080090.10		7	1.4	9	x70090140.10
5.5	1.1	22		x55220110.10		6	0.75	9	x60090075.9		7	1.4	10	x70100140.10

Andere Abmessungen auf Anfrage

Autres dimensions sur demande

Further dimensions on request

Werkstoff/Matière/ Material
 .1 = Aluminium
 .4 = Kupfer/cuivre/copper
 .6 = Messing/laiton/brass
 .9 = Stahl/acier/steel

■ = Oberflächen/Surface/Surface-plating
 Seite/page/page 5.011

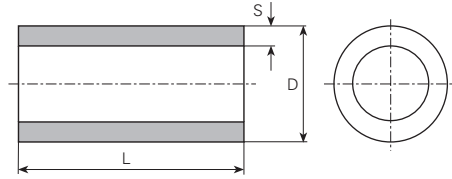

für Bolzen pour borne for stud mm	øD mm	S mm	L mm	Artikelnummer Numéro d'article Part-No.	für Bolzen pour borne for stud mm	øD mm	S mm	L mm	Artikelnummer Numéro d'article Part-No.	für Bolzen pour borne for stud mm	øD mm	S mm	L mm	Artikelnummer Numéro d'article Part-No.
	7	1.35	10.2	x70102135.10		8	1.4	5	x80050140.10		8	1.4	35	x80350140.10
	7	1.4	11	x70110140.10		8	1.2	6	x80060120.9 ■		8	1.4	36	x80360140.10
	7	1.4	12	x70120140.10		8	1.4	6	x80060140.10		8	1.2	38	x80380120.9 ■
	7	1.4	13	x70130140.10		8	1.2	6.5	x80065120.9 ■		8	1.2	40	x80400120.9 ■
	7	1.4	14	x70140140.10		8	1.2	7	x80070120.9 ■		8	1.4	40	x80400140.10
	7	1.4	15	x70150140.10		8	1.4	7	x80070140.10		8	1.2	80	x80800120.9 ■
	7	1.4	16	x70160140.10		8	1.2	8	x80080120.9 ■	M6	7	0.5	7.5	x70075050.6 ■
	7	1.4	16.5	x70165140.10		8	1.4	8	x80080140.10		7	0.5	8	x70080050.6 ■
	7	1.4	17	x70170140.10		8	1.2	9	x80090120.9 ■		8	1	3	x80030100.10
	7	1.4	17.2	x70172140.10		8	1.4	9	x80090140.10		8	1	5	x80050100.9 ■
	7	1.4	18	x70180140.10		8	1.4	9.5	x80095140.10		8	0.5	5	x80050050.6 ■
	7	1.4	20	x70200140.10		8	1.2	10	x80100120.9 ■		8	1	6.5	x80065100.10
	7	1.4	22	x70220140.10		8	1.4	10	x80100140.10		8	0.5	8	x80080050.6 ■
	7	1.4	25	x70250140.10		8	1.2	12	x80120120.9 ■		8	1	13	x80130100.10
	7	1.4	30	x70300140.10		8	1.4	12	x80120140.10		8	1	17	x80170100.9 ■
	8	1.6	5	x80050160.9 ■		8	1.2	13	x80130120.9 ■		10	1.8	4	x1000401809 ■
M5	6	0.5	5	x60050050.10		8	1.2	14	x80140120.9 ■		10	1.8	5	x1000501809 ■
	6	0.5	12	x60120050.6 ■		8	1.4	14	x80140140.10		10	1.8	6	x1000601809 ■
	6	0.5	12.7	x60127050.6 ■		8	1.1	15	x80150110.9 ■		10	1.8	7	x1000701809 ■
	6	0.48	15.5	x60155048.6 ■		8	1.2	15	x80150120.9 ■		10	1.8	8	x1000801809 ■
	6	0.5	40	x60400050.9 ■		8	1.4	15	x80150140.10		10	1.8	9	x1000901809 ■
	6.5	0.75	3	x65030075.10		8	1.2	16	x80160120.9 ■		10	1.8	10	x1001001809 ■
	7	1	2	x70020100.10		8	1.4	16	x80160140.10	10	1.8	11	x1001101809 ■	
	7	1	4	x70040100.10		8	1.2	17	x80170120.9 ■	10	1.8	12	x1001201809 ■	
	7	1	5	x70050100.10		8	1.2	18	x80180120.9 ■	10	1.8	13	x1001301809 ■	
	7	1	5	x70050100.6 ■		8	1.4	18	x80180140.10	10	1.8	15	x1001501809 ■	
	7	1	9	x70090100.6 ■		8	1.4	19	x80190140.10	10	1.8	24	x1002401809 ■	
	7	1	13	x70130100.6 ■		8	1.2	20	x80200120.9 ■	10	1.8	28	x1002801809 ■	
	7	1	15	x70150100.6 ■		8	1.4	20	x80200140.10	10	1.8	30	x1003001809 ■	
	7	1	16	x70160100.6 ■		8	1.2	21	x80210120.9 ■	10	1.8	35	x1003501809 ■	
	7	1	18	x70180100.10		8	1.2	22	x80220120.9 ■	10	1.8	45	x1004501809 ■	
	8	1.2	3	x80030120.9 ■		8	1.4	25	x80250140.10	M8	10	0.8	6	x1000600809 ■
8	1.4	3	x80030140.10		8	1.2	26	x80260120.9 ■	12		1.8	12	x1201201809 ■	
8	1.4	3.5	x80035140.10		8	1.4	26.5	x80265140.10	12		1.8	14	x1201401809 ■	
8	1.2	4	x80040120.9 ■		8	1.4	28	x80280140.10	M10	12	0.7	6	x1200600709 ■	
8	1.4	4	x80040140.10		8	1.2	30	x80300120.9 ■		M12	15	0.8	6	x1500600809 ■
8	1.4	4.5	x80045140.10		8	1.4	30	x80300140.10						
8	1.2	5	x80050120.9 ■		8	1.2	32	x80320120.9 ■						

Andere Abmessungen auf Anfrage

Autres dimensions sur demande

Further dimensions on request

Rohrabschnitte Pièces tubulaires cylind. Cylindrical tubular pcs

Werkstoff/Matière/Material
 .4 = Kupfer/cuivre/copper
 .6 = Messing/laiton/brass
 .8 = rostfreier Stahl/acier inox/stainless steel
 .9 = Stahl/acier/steel

■ = Oberflächen/Surface/Surface-plating
 Seite/page/page 5.011

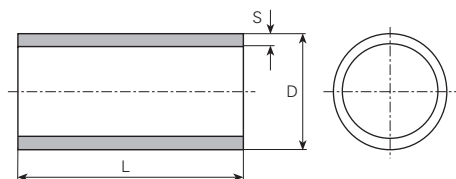

øD mm	S mm	L mm	Artikelnummer Numéro d'article Part-No.	øD mm	S mm	L mm	Artikelnummer Numéro d'article Part-No.	øD mm	S mm	L mm	Artikelnummer Numéro d'article Part-No.
1	0.2	5.7	x10057020.6								
1.1	0.15	2	x11020015.6		0.3	3	x20030030.9		0.5	51.5	x30515050.6
1.2	0.2	3	x12030020.6		0.3	7	x20070030.6		0.7	4	x30040070.4
	0.2	8	x12080020.6		0.4	1.5	x20015040.6		0.7	8.2	x30082070.4
	0.2	10	x12100020.6		0.4	8	x20080040.6	3.5	0.25	12	x35120025.6
1.34	0.12	3.5	x13035012.4		0.4	9	x20090040.6		0.25	14.5	x35145025.6
	0.12	9.5	x13095012.4		0.4	34	x20340040.6	3.7	0.25	4	x37040025.80
	0.12	12	x13120012.4		0.5	6	x20060050.6	3.8	0.3	8	x38080030.6
1.4	0.2	4	x14040020.6		0.5	9	x20090050.6	4	0.25	12	x40120025.6
	0.15	6	x14060015.4		0.5	9.5	x20095050.6		0.25	16	x40160025.9
	0.2	6	x14060020.6		0.5	12.5	x20125050.6		0.3	3	x40030030.6
	0.2	8	x14080020.6		0.5	20	x20200050.6		0.3	8	x40080030.6
	0.2	10	x14100020.6		0.5	48	x20480050.6		0.3	10	x40100030.6
1.5	0.2	6	x15060020.6	2.2	0.2	5	x22050020.6		0.3	12	x40120030.6
	0.2	7	x15070020.6		0.2	10	x22100020.6	4.04	0.46	17	x40170046.4
	0.2	10	x15100020.6	2.3	0.25	33	x23330025.6		0.54	120	x4012000544
	0.25	2	x15020025.6	2.4	0.4	17	x24170040.6		0.54	170	x4017000544
	0.25	3	x15030025.6	2.5	0.2	2	x25020020.6	4.5	0.25	8.5	x45085025.6
	0.25	4	x15040025.6		0.2	3	x25030020.6	5	0.35	5.5	x50055035.6
	0.25	5	x15050025.6		0.2	5	x25050020.6		0.4	22	x50220040.4
	0.25	12	x15120025.6		0.2	6.5	x25065020.6		0.5	12	x50120050.6
1.6	0.1	5	x16050010.6		0.2	8	x25080020.6		0.5	17	x50170050.4
	0.1	22	x16220010.6		0.2	12	x25120020.6	5.2	0.2	3	x52030020.6
	0.1	24	x16240010.6		0.25	3	x25030025.6		0.2	25	x52250020.6
	0.15	3	x16030015.6		0.25	3	x25030025.9	5.5	0.25	3	x55030025.6
1.7	0.2	3	x17030020.4		0.25	5	x25050025.6		0.25	7.3	x55073025.6
	0.2	4	x17040020.4		0.25	5	x25050025.9		0.25	8	x55080025.6
	0.2	5	x17050020.6		0.25	10	x25100025.80	6	0.25	2	x60020025.6
	0.2	8	x17080020.6		0.3	5	x25050030.6		0.25	5	x60050025.6
	0.25	3	x17030025.4		0.4	9	x25090040.6		0.25	15	x60150025.6
1.9	0.2	1.5	x19015020.6		0.4	16	x25160040.6	6.9	1.45	4.5	x69045145.6
	0.2	5	x19050020.6		0.4	18	x25180040.6	7.5	0.2	7	x75070020.6
2	0.2	7	x20070020.6		0.5	30	x25300050.4	8.9	0.22	8.5	x89085022.4
	0.25	5	x20050025.6	3	0.25	6	x30060025.6	9.3	0.25	2.5	x93025025.6
	0.25	15	x20150025.9		0.25	7	x30070025.6	9.5	0.5	2	x95020050.6
					0.3	10	x30100030.6	16.5	1.25	1	x1650101256

Andere Abmessungen auf Anfrage

Autres dimensions sur demande

Further dimensions on request

Isolier Distanz-Rollen Kunststoff

Entretoises isolantes

Insulating spacers

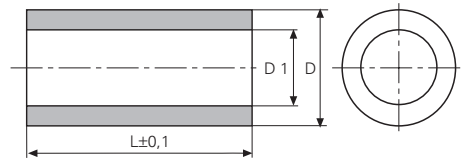

Werkstoff:
 PS=Polystyrol, schwarz
 PA=Polyamid, schwarz
 PC=Polycarbonat, grau

Temperaturbeständigkeit:
 PS -10°C bis +80°C
 PA -40°C bis +110°C
 PC -50°C bis +135°C

Matière:
 PS=polystyrène, noire
 PA=polyamide, noire
 PC=polycarbonate, gris

Résistant à une température de:
 PS -10°C à +80°C
 PA -40°C à +110°C
 PC -50°C à +135°C

Material:
 PS=polystyrene, black
 PA=polyamid, black
 PC=polycarbonate, grey

Temperature range:
 PS -10°C up to +80°C
 PA -40°C up to +110°C
 PC -50°C up to +135°C

für Bolzen pour borne for stud mm	øD mm	øD1 mm	L mm	Artikelnummer Numéro d'article Part-No.	für Bolzen pour borne for stud mm	øD mm	øD1 mm	L mm	Artikelnummer Numéro d'article Part-No.
M2.5	5	2.7	2	x05002027.pa		7	3.6	14	x07014036.ps
	5	2.7	3	x05003027.pa		7	3.6	15	x07015036.pc
	5	2.7	5	x05005027.pa		7	3.6	15	x07015036.ps
	5	2.7	7.5	x05007527.pa		7	3.6	16	x07016036.ps
	5	2.7	10	x05010027.pa		7	3.6	17	x07017036.ps
	5	2.7	13.5	x05013527.pa		7	3.6	18	x07018036.pc
	5	2.7	15	x05015027.pa		7	3.6	18	x07018036.ps
	5	2.7	20	x05020027.pa		7	3.6	18.5	x07018536.pc
M3	6	3.2	3	x06003032.pa		7	3.6	19	x07019036.ps
	6	3.2	4.5	x06004532.pa		7	3.6	20	x07020036.pc
	6	3.2	5	x06005032.pa		7	3.6	20	x07020036.ps
	6	3.2	5.6	x06005632.pa		7	3.6	25	x07025036.pc
	6	3.2	6.4	x06006432.pa		7	3.6	25	x07025036.ps
	6	3.2	7	x06007032.pa		7	3.6	27	x07027036.ps
	6	3.2	7.4	x06007432.pa		7	3.6	28.8	x07028836.pc
	6	3.2	8	x06008032.pa		7	3.6	30	x07030036.pc
	6	3.2	9	x06009232.pa		7	3.6	30	x07030036.ps
	6	3.2	10	x06010032.pa		7	3.6	35	x07035036.pc
	6	3.2	15	x06015032.pa		7	3.6	35	x07035036.ps
	6	3.2	20	x06020032.pa		M4	7	4.1	10
	6	3.2	30	x06030032.pa	8		4.5	3	x08003045.pc
	7	3.6	2	x07002036.pc	8		4.5	3	x08003045.ps
	7	3.6	3	x07003036.pc	8		4.5	4	x08004045.ps
	7	3.6	3	x07003036.ps	8		4.5	5	x08005045.pa
	7	3.6	4	x07004036.ps	8		4.5	5	x08005045.pc
	7	3.6	5	x07005036.pc	8		4.5	5	x08005045.ps
	7	3.6	5	x07005036.ps	8		4.5	6	x08006045.ps
	7	3.6	6	x07006036.pc	8		4.5	7	x08007045.ps
	7	3.6	6	x07006036.ps	8		4.5	8	x08008045.pc
	7	3.6	6.5	x07006536.ps	8		4.5	8	x08008045.ps
	7	3.6	7	x07007036.pc	8		4.5	9	x08009045.ps
7	3.6	7	x07007036.ps	8	4.5		10	x08010045.pa	
7	3.6	8	x07008036.pc	8	4.5		10	x08010045.pc	
7	3.6	8	x07008036.ps	8	4.5		10	x08010045.ps	
7	3.6	9	x07009036.ps	8	4.5	11	x08011045.ps		
7	3.6	10	x07010036.pc	8	4.5	12	x08012045.ps		
7	3.6	10	x07010036.ps	8	4.5	13	x08013045.ps		
7	3.6	11	x07011036.ps	8	4.5	14	x08014045.ps		
7	3.6	12	x07012036.ps	8	4.2	15	x08015042paw		
7	3.6	13	x07013036.ps	8	4.5	15	x08015045.pa		
				8	4.5	15	x08015045.pc		

Andere Abmessungen auf Anfrage

Autres dimensions sur demande

Further dimensions on request

für Bolzen pour borne for stud mm	øD mm	øD1 mm	L mm	Artikelnummer Numéro d'article Part-No.	für Bolzen pour borne for stud mm	øD mm	øD1 mm	L mm	Artikelnummer Numéro d'article Part-No.
	8	4.5	15	x08015045.ps		10	5.5	10	x10010055.ps
	8	4.2	20	x08020042paw		10	5.5	15	x10015055.pc
	8	4.5	20	x08020045.pa		10	5.5	15	x10015055.ps
	8	4.5	20	x08020045.pc		10	5.5	20	x10020055.pc
	8	4.5	20	x08020045.ps		10	5.5	20	x10020055.ps
	8	4.5	25	x08025045.pc		10	5.5	25	x10025055.pc
	8	4.5	25	x08025045.ps		10	5.5	25	x10025055.ps
	8	4.5	30	x08030045.pa		10	5.5	30	x10030055.pc
	8	4.5	30	x08030045.pc		10	5.5	30	x10030055.ps
	8	4.5	30	x08030045.ps		10	5.5	35	x10035055.pc
	8	4.5	35	x08035045.pc		10	5.5	35	x10035055.ps
	8	4.5	35	x08035045.ps		10	5.5	35	x10035055.ps
M5	10	5.5	2.5	x100025550pc	M6	10	6.2	5	x10005062.pa
	10	5.5	3	x10003055.pc		10	6.2	5	x10005062.ps
	10	5.5	3	x10003055.ps		10	6.2	10	x10010062.pa
	10	5.2	5	x10005052.pa		10	6.2	10	x10010062.ps
	10	5.2	5	x10005052paw		10	6.2	15	x10015062.ps
	10	5.2	10	x10010052.pa		10	6.2	20	x10020062.pa
	10	5.2	20	x10020052.pa		10	6.2	20	x10020062.ps
	10	5.2	30	x10030052.pa		10	6.2	25	x10025062.ps
	10	5.5	5	x10005055.pc		10	6.2	30	x10030062.pa
	10	5.5	5	x10005055.ps		10	6.2	30	x10030062.ps
	10	5.5	10	x10010055.pc		10	6.2	35	x10035062.ps

Andere Abmessungen auf Anfrage

Autres dimensions sur demande

Further dimensions on request

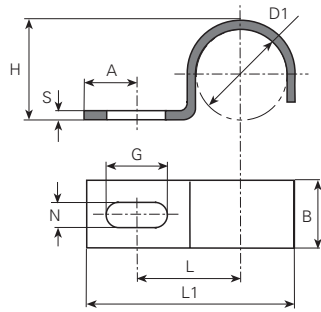

Werkstoff/Matière/Material:
 .99 = Stahl verzinkt / Acier zingué / steel zinc-plated

øD1 mm	L mm	L1 mm	A mm	N mm	G mm	B mm	H mm	S mm	Artikelnummer Numéro d'article Part-No.
4	6.5	14	4.5	3.6	4.8	8	5	0.8	5000.99
4.5	7	14.5	4.5	3.6	4.8	8	4.8	0.8	5001.99
5	7.5	14.7	4	3.6	4.8	8	5	0.8	5002.99
6	7.2	15	3.8	3.6	4.8	8	6.4	0.8	5003.99
7	8.5	16.5	3.8	3.6	4.5	8	6.8	0.8	5004.99
	8.5	16.5	3.5	4.2	4.5	8	6.8	0.8	5004a.99
8	9.2	18.2	3.8	4.2	4.8	8	8	0.8	5005.95
	9.2	18.2	3.8	4.2	4.8	8	8	0.8	5005.99
9	13	23.7	6	4.2	5.7	9	8.8	1	5006.99
11	12.3	24	4.7	4.5	6	9	10.8	1	5007.99

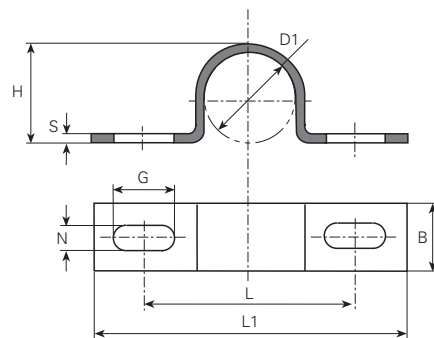

øD1 mm	L mm	L1 mm	N mm	G mm	B mm	H mm	S mm	Artikelnummer Numéro d'article Part-No.
7	20	29.5	4.2	5.7	10	8	1	5100.99
9.5	21.6	29.5	4.2	6	10	10.4	0.9	5101.99
11	25	35	4.2	6	10	11.8	1.2	5102.99
13	26	38	4.2	5.7	10	14	0.9	5103.99

Werkstoff/Matière/Material:

- .60 = Messing blank / laiton brut / brass clean
- .65 = Messing vernickelt / laiton nickelé / brass nickel-plated
- .69 = Messing verzinkt / laiton zingué / brass zinc-plated
- .80 = rostfreier Stahl blank / acier inox brut / stainless steel clean
- .95 = Stahl vernickelt / acier nickelé / steel nickel-plated
- .99 = Stahl verzinkt / acier zingué / steel zinc-plated
- .pr = Presspan / presspan / pressboard

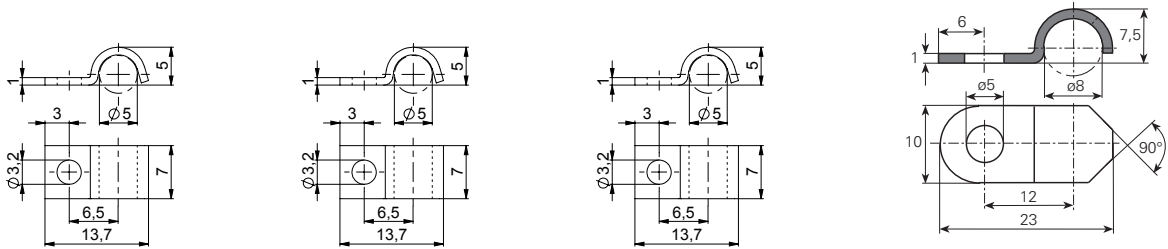

Artikelnummer
Numéro d'article
Part-No.

5112.65

5112.95

5112.99

5113.65

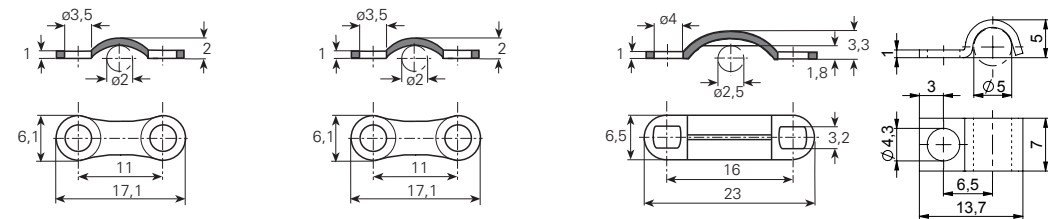

Artikelnummer
Numéro d'article
Part-No.

5114.60

5114.99

5115.99

5116.99

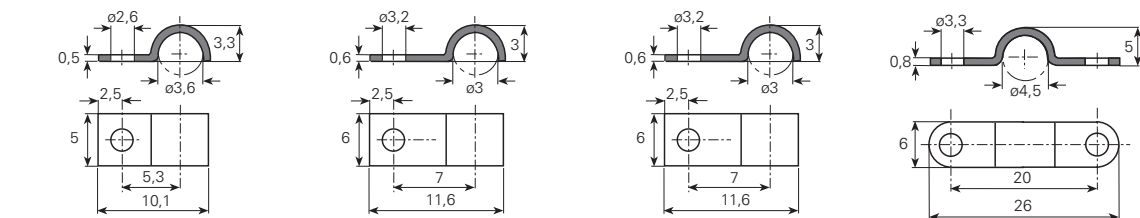

Artikelnummer
Numéro d'article
Part-No.

5117.80

5118.95

5118.99

5120a.99

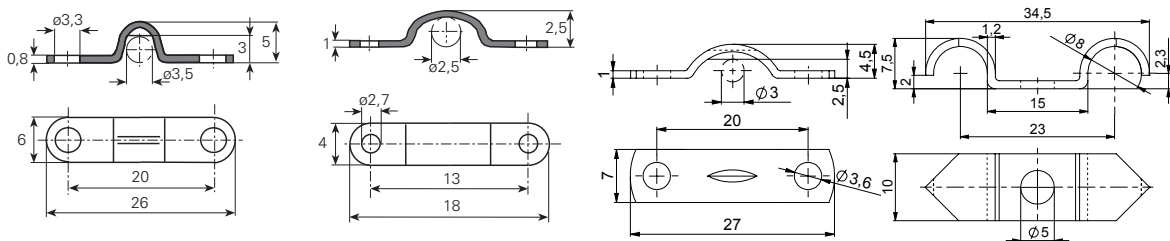

Artikelnummer
Numéro d'article
Part-No.

5120b.99

5121.99

5122.99

5123.69

Kabelbriden

Brides de câble

Cable clips

Werkstoff/Matière/Material:

- .60 = Messing blank / laiton brut / brass clean
- .65 = Messing vernickelt / laiton nickelé / brass nickel-plated
- .69 = Messing verzinkt / laiton zingué / brass zinc-plated
- .80 = rostfreier Stahl blank / acier inox brut / stainless steel clean
- .95 = Stahl vernickelt / acier nickelé / steel nickel-plated
- .99 = Stahl verzinkt / acier zingué / steel zinc-plated
- .pr = Presspan / presspan / pressboard

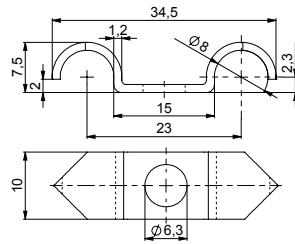

Artikelnummer
Numéro d'article
Part-No.

5124.60

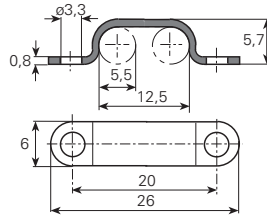

5125.99

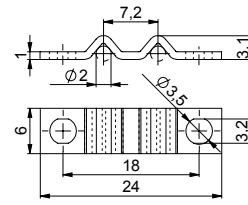

5126.60

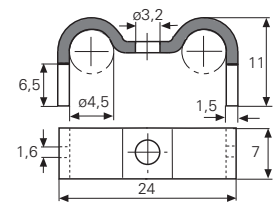

5130.99

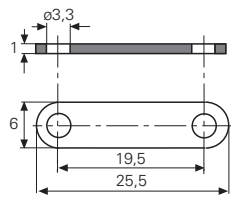

Artikelnummer
Numéro d'article
Part-No.

5135.99

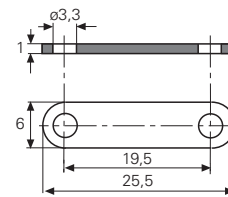

5135.pr

Klemmscheiben und Klemmbügel

Rondelles de serrage

Clamping disks

Werkstoff/Matière/Material
 .5 = Federstahl/acier ressort/spring steel

■ = Oberflächen/Surface/Surface-plating
 Seite/page/page 5.011

Form A

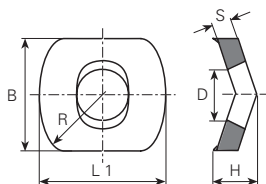

Form B

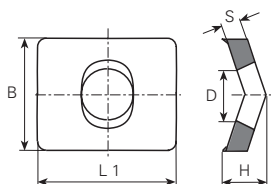

Form H

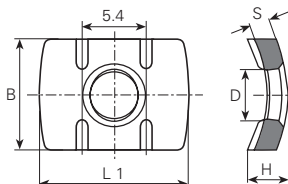

Anschluss-Scheiben

plaquettes de raccordement

connecting disks

für Bolzen pour borne for stud mm	Form	∅D mm	B mm	H mm	L1 mm	R mm	S mm	Artikelnummer Numéro d'article Part-No.
M3	A	3.5	6.9	1.8	7.5	5	0.8	6432.5 ■
M3.5	B	3.7	6.3	1.3	7.2		0.8	6413a.5 ■
	A	3.6	6.9	2.5	8.5		1.4	6414a.5 ■
M4	A	4	7.8	3	10.5	7	1.5	6424a.5 ■
	H	4.05	9.5	3.4	12.7		1.7	6425b.5 ■
	B	4.3	8	3	10		1.5	6422.5 ■

Werkstoff/Matière/Material
 .5 = Federstahl/acier ressort/spring steel
 .6 = Messing/laiton/brass
 .9 = Stahl/acier/steel

■ = Oberflächen/Surface/Surface-plating
 Seite/page/page 5.011

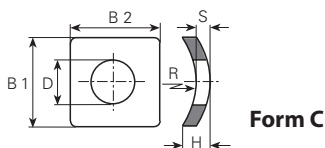

Form C

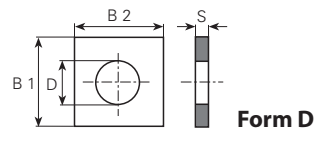

Form D

Klemmscheiben

rondelles de serrage

clamping disks

für Bolzen pour borne for stud mm	Form	∅D mm	B1 mm	B2 mm	S mm	H mm	R mm	Artikelnummer Numéro d'article Part-No.
M2.5	C	2.7	5.9	7	1	2.6	3.5	6441.5 ■
M3	D	3.5	6	6	0.5			6410.6 ■
	C	3.2	5.8	5.8	0.7	1.2	7	6412.5 ■
M3.5	C	3.7	7.2	7.2	0.8	1.7	8	6414.5 ■
M4	C	4.3	8.7	8.7	1	2	9	6416.5 ■
	C	4.3	9.1	8.5	1	1.9	12	6444.5 ■
	D	4.3	8	8	0.8			6464.9 ■
M5	C	5.3	11.2	11.2	1.4	2.9	11	6418.5 ■
M6	C	6.4	14.2	14.2	1.8	3.9	13	6420.5 ■

Anwendungsbeispiele / exemples d'utilisation / examples of application

Anschluss mit einem Leiter
 Raccordement avec un conducteur
 Connexion with one wire

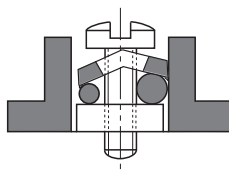
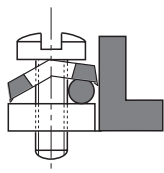

Anschluss mit zwei verschiedenen Leitern
 Raccordement avec deux conducteurs différents
 Connexion with two different wires

Werkstoff/Matière/ Material
 .6 = Messing/laiton/brass
 .8 = rostfreier Stahl/acier inox/stainless steel
 .9 = Stahl/acier/steel

■ = Oberflächen/Surface/Surface-plating
 Seite/page/page 5.011

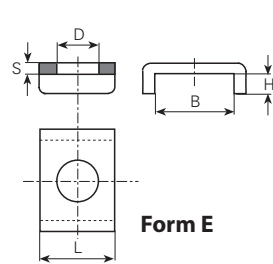

Form E

Klemmbügel

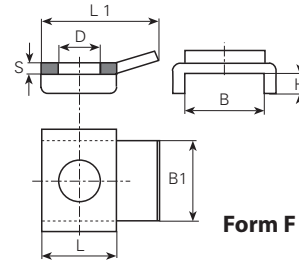

Form F

étriers de serrage

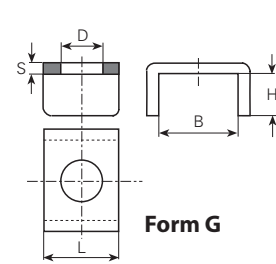

Form G

clamping straps

für Bolzen pour borne for stud mm	Form	øD mm	B mm	L mm	H mm	B1 mm	L1 mm	S mm	Artikelnummer Numéro d'article Part-No.
M3	E	3.2	5.3	6	2			1	6401c.6 ■
	E	3.2	6.2	6	2			1	6402c.6 ■
	E	3.6	6.4	6	2.2			1	6405c.9 ■
	E	3.4	7	6	1			1	6500e.6 ■
	E	3.4	7	6	2.5			1	6501e.6 ■
	G	3.4	7	6	4.5			1	6501g.6 ■
	E	3.6	7	6	2.5			1	6502e.6 ■
M3.5	E	3.9	6.2	6	2			1	6403c.6 ■
	E	3.9	8.1	8	2.5			1	6403e.6 ■
M4	E	4.8	8.4	8	2.5			1.2	64064c.80
	E	4.8	8.4	8	2.5			1.2	64064c.9 ■
	E	4.9	8.5	8	3.5			1.25	64064d.80
	E	4.6	7.2	8.5	3.6			1.5	6407c.6 ■
	E	4.6	7.2	8.5	3.6			1.5	6407c.9 ■
	E	4.5	8.4	8	2.8			1.5	64084c.6 ■
	E	4.5	10.5	8	3.5			1.5	6503e.9 ■
	F	4.5	10.5	8	3.5	9.5	13	1.5	6503f.6 ■
	G	4.5	10.5	8	5.5			1.5	6503g.9 ■
E	4.5	6.9	8.5	3.2			0.8	6506e.9 ■	
M5	E	5.3	8.4	8	2.8			1.2	64065c.9 ■
	E	5.7	10.5	10	2.5			1.5	64085c.6 ■
	E	5.5	12.5	10	4			1.8	6504e.6 ■
	E	5.5	12.5	10	4			1.8	6504e.9 ■
	F	5.5	10.3	10	2.5	10.1	16	1.2	6505e.80
	F	5.5	10.3	10	2.5	10.1	16	1.5	6505f.6 ■
	F	5.5	10.3	10	2.5	10.1	16	1.2	6505k.80
E	5.5	10.3	10	2.5			1.2	6507e.80	
M6	E	7	12.5	12	3.5			1.8	6417c.6 ■
	E	7	12.5	12	3.5			1.8	6417c.80
	E	7	12.5	12	3.5			1.8	6417c.9 ■
	G	7	16.2	14	4.8			1.8	6417g.6 ■
M8	G	8.5	16.2	14	4.8			1.8	6419g.6 ■

Klemmscheiben und Klemmbügel

Rondelles de serrage

Clamping disks

Werkstoff/Matière/Material
 .5 = Federstahl/acier ressort/spring steel
 .6 = Messing/laiton/brass
 .8 = rostfreier Stahl/acier inox/stainless steel
 .9 = Stahl/acier/steel

■ = Oberflächen/Surface/Surface-plating
 Seite/page/page 5.011

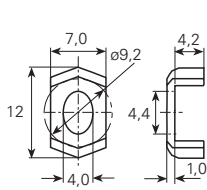

Artikelnummer
 Numéro d'article
 Part-No.

6409.6■

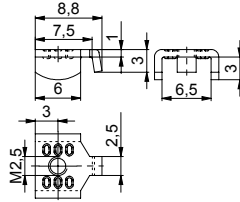

6442.80

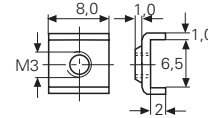

6443.6■

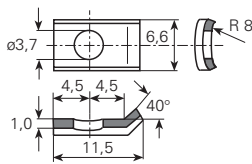

Artikelnummer
 Numéro d'article
 Part-No.

6414c.5■

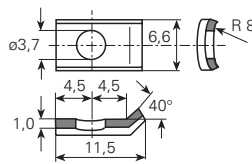

6414c.9■

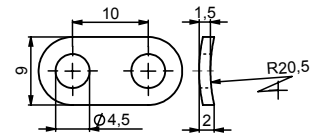

6445.5■

Anwendungsbeispiele / exemples d'utilisation / examples of application

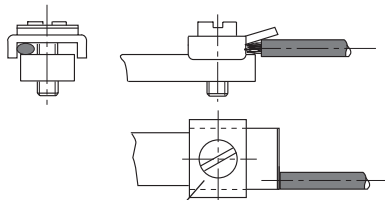

Anschluss mit einem Leiter
 Raccordement avec un conducteur
 Connexion with one wire

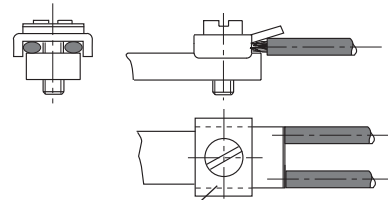

Anschluss mit zwei verschiedenen Leitern
 Raccordement avec deux conducteurs différents
 Connexion with two different wires

Werkstoff/Matière/Material
 AL = Aluminium
 BE = Berylliumkupfer
 BZ = Bronze
 CU = Kupfer
 FS = Federstahl
 HP = Hartpapier
 MS = Messing
 PA = Polyamid
 PR = Presspan
 PV = PVC
 RF = rostfreier Stahl
 ST = Stahl
 TF = PTFE

■ = Oberflächen/Surface/Surface-plating
 Seite/page/page 5.011

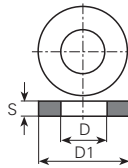

Werkstoff Matière Material	øD mm	øD1 mm	S mm	Artikelnummer Numéro d'article Part-No.	Werkstoff Matière Material	øD mm	øD1 mm	S mm	Artikelnummer Numéro d'article Part-No.
AL	3.2	6	1.5	p03206015010		12.4	25	0.8	p1242500805■
	3.2	7	0.4	p03207004010		15	28	1	p1502801005■
	3.2	7	0.5	p03207005010		15.3	18	0.3	p1531800305■
	3.2	7	0.6	p03207006010		HP	1.2	4.8	0.8
	3.2	7	1.5	p03207015010	1.3		2.5	0.3	p013025030hp
	4.2	10	0.8	p04210008010	1.5		3	0.3	p015030030hp
	6.2	10	0.5	p06210005010	1.6		6	0.3	p016060030hp
	BE	2.2	5	0.2	p0220500202■	2.2	4.5	0.5	p022045050hp
BZ		1.64	2.3	0.2	p0160230202■	2.2	5	0.3	p022050030hp
	FS	5.1	10	0.1	p0511000102■	2.2	5	0.5	p022050050hp
FS		2.2	5	0.1	p0220500105■	2.2	5.5	1	p022055100hp
	2.9	8	0.3	p0290800305■	2.5	5	0.3	p025050030hp	
	3.2	5.5	0.1	p0320550105■	2.5	5	0.5	p025050050hp	
	3.2	6	0.1	p0320600105■	2.8	4.5	0.5	p028045050hp	
	3.2	6	0.2	p0320600205■	2.8	5	0.3	p028050030hp	
	3.2	7	0.1	p0320700105■	2.8	5	0.5	p028050050hp	
	3.6	5.8	0.2	p0360580205■	2.8	5.5	0.5	p028055050hp	
	3.6	5.8	0.3	p0360580305■	2.8	6	0.8	p028060080hp	
	3.6	6	0.1	p0360600105■	2.8	6	1	p028060100hp	
	3.6	6	0.2	p0360600205■	2.8	8	0.5	p028080050hp	
	3.6	6	0.3	p0360600305■	3.2	6	0.2	p032060020hp	
	4.1	7	0.3	p0410700305■	3.2	6	0.5	p032060050hp	
	4.1	16	0.5	p0411600505■	3.2	6	1	p032060100hp	
	4.2	7	0.1	p0420700105■	3.2	6	1.5	p032060150hp	
	4.2	8	0.2	p0420800205■	3.2	8	1	p032080100hp	
	4.3	8	0.15	p0430800155■	3.2	9	0.5	p032090050hp	
	4.3	10	0.2	p0431000205■	3.2	10	1	p032100100hp	
	4.3	10	0.4	p0431000405■	3.2	10	2	p032100200hp	
	5.2	8	0.05	p0520800055■	3.2	12	1	p032120100hp	
	5.2	8	0.1	p0520800105■	3.2	13.8	2	p032138200hp	
	5.3	8	0.2	p0530800205■	3.2	30	1.5	p032300150hp	
	6.1	8.8	0.2	p0610880205■	3.3	8	1	p033080100hp	
	6.2	10	0.05	p0621000055■	3.7	7	0.8	p037070080hp	
	6.2	10	0.1	p0621000105■	3.7	9	0.8	p037090080hp	
	6.4	8	0.1	p0640800105■	4	6	1.5	p040060150hp	
	8	13.8	0.2	p0801380205■	4.2	5.5	0.5	p042055050hp	
	12.35	17.6	0.5	p1231760505■	4.2	6	0.2	p042060020hp	
						4.2	6	1	p042060100hp

Andere Abmessungen auf Anfrage

Autres dimensions sur demande

Further dimensions on request



Verbindungstechnik

Scheiben Rondelles Washers

Werkstoff Matière Material	øD mm	øD1 mm	S mm	Artikelnummer Numéro d'article Part-No.	Werkstoff Matière Material	øD mm	øD1 mm	S mm	Artikelnummer Numéro d'article Part-No.
	4.2	7	0.2	p042070020hp		3.2	6	0.3	p0320600306
	4.2	9	0.8	p042090080hp		3.2	6	0.5	p0320600506
	4.2	10	0.8	p042100080hp		3.2	6	0.8	p0320600806
	4.2	10	1	p042100100hp		3.2	6	1	p0320601006
	4.2	15	0.5	p042150050hp		3.2	7	0.5	p0320700506
	4.3	8	0.5	p043080050hp		3.2	8	0.1	p0320800106
	4.5	8	0.3	p045080030hp		3.2	8	0.2	p0320800206
	4.8	12	1	p048120100hp		3.2	8	0.3	p0320800306
	5.3	12	0.5	p053120050hp		3.2	8	0.5	p0320800506
	5.3	20	1.5	p053200150hp		3.2	12	1	p0321201006
	5.6	11	0.3	p056110030hp		3.7	6	0.5	p0370600506
	6	11	0.5	p060110050hp		3.7	7	0.5	p0370700506
	6	11	1.2	p060110120hp		3.7	8	0.5	p0370800506
	6	11	1.5	p060110150hp		4.2	6	0.5	p0420600506
	6.1	8.5	0.2	p061085020hp		4.2	6.4	0.5	p0420640506
	6.1	20	0.5	p061195050hp		4.2	7	0.5	p0420700506
	6.2	10	0.5	p062100050hp		4.2	7	1.2	p0420701206
	6.2	11	0.5	p062110050hp		4.2	8	0.5	p0420800506
	6.3	9	0.5	p063090050hp		4.2	8	0.8	p0420800806
	6.3	13	1	p063130100hp		4.2	9	0.6	p0420900606
	7	14	1.4	p070140140hp		4.2	10	0.5	p0421000506
	8	11	0.2	p080110020hp		4.2	10	0.8	p0421000806
	8	11	0.3	p080110030hp		4.3	6.5	0.5	p0430650506
	8	18	0.5	p080180050hp		4.3	7.5	0.5	p0430750506
	9	18	1.5	p090180150hp		4.3	8	0.5	p0430800506
	10	14	0.2	p100140020hp		4.3	12	1	p0431201006
	10.5	21	0.8	p105210080hp		5.2	8	0.7	p0520800706
	10.5	22	0.8	p105220080hp		5.3	8	0.5	p0530800506
	12.5	19	1	p125190100hp		5.3	8	0.8	p0530800806
	12.8	20	0.5	p128200050hp		5.3	9	0.5	p0530900506
CU	5.3	8	0.6	p0530800604		5.3	10	0.5	p0531000506
MS	1.5	2.5	0.4	p0150250406		5.3	10	0.8	p0531000806
	1.5	2.5	0.8	p0150250806		5.3	12	0.5	p0531200506
	1.5	3	0.3	p0150300306		5.3	12	0.8	p0531200806
	1.5	4.5	0.5	p0150450506		5.6	11	0.2	p0561100206
	1.8	4	0.3	p0180400306		6	16.9	0.5	p0601690506
	1.8	4.5	0.3	p0180450306		6.1	8.8	0.3	p0610880306
	1.8	5.5	0.5	p0180550506		6.1	8.8	0.5	p0610880506
	2.1	4	0.5	p0210400506		6.1	8.8	0.8	p0610880806
	2.1	6.5	0.4	p0210650406		6.2	10	0.5	p0621000506
	2.2	4.5	0.5	p0220450506		6.3	9	0.5	p0630900506
	2.2	4.8	0.3	p0220480306		6.3	9	0.8	p0630900806
	2.2	5.5	0.5	p0220550506		6.3	12	0.5	p0631200506
	2.2	5.5	1	p0220551006		6.3	14	1.5	p0631401506
	2.2	10	0.3	p0221000306		7.2	12	0.5	p0721200506
	2.5	5	0.4	p0250500406		8	11.5	1	p0801151006
	2.5	5	0.5	p0250500506		8	11.5	1.5	p0801151506
	2.5	6	0.5	p0250600506		8	12	1	p0801201006
	2.8	5	0.5	p0280500506		10.5	22	0.5	p1052200506
	2.8	5.5	0.5	p0280550506		12.4	23	0.5	p1242300506
	2.8	5.6	0.3	p0280560306		12.4	23	1.0	p1242301006
	2.8	7	0.5	p0280700506	PA	2.2	6	0.5	p022060050pa
	3	5	1	p0300501006		2.5	5	0.5	p025050050pa
	3.2	5	0.5	p0320500506		3.2	6	0.8	p032060080pa
	3.2	5.5	0.5	p0320550506		3.2	8	1	p032080100pa
	3.2	6	0.1	p0320600106					

Andere Abmessungen auf Anfrage

Autres dimensions sur demande

Further dimensions on request

Werkstoff/Matière/Material
 AL = Aluminium
 BE = Berylliumkupfer
 BZ = Bronze
 CU = Kupfer
 FS = Federstahl
 HP = Hartpapier
 MS = Messing
 PA = Polyamid
 PR = Presspan
 PV = PVC
 RF = rostfreier Stahl
 ST = Stahl
 TF = PTFE

■ = Oberflächen/Surface/Surface-plating
 Seite/page/page 5.011

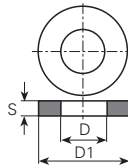

Werkstoff Matière Material	øD mm	øD1 mm	S mm	Artikelnummer Numéro d'article Part-No.	Werkstoff Matière Material	øD mm	øD1 mm	S mm	Artikelnummer Numéro d'article Part-No.
	3.2	8	3	p032080300pa		4.2	8	0.5	p042080050pr
PR	4.2	8	1	p042080100pr		4.2	10	0.5	p042100050pr
PA	4.2	10	0.25	p042100025pa		4.2	10	1	p042100100pr
	4.5	8	0.3	p045080030pa		4.8	12	0.8	p048120080pr
	4.5	8	0.5	p045080050pa		5.3	8	0.5	p053080050pr
	5.3	8	0.5	p053080050pa		5.3	8	1	p053080100pr
	5.5	16	0.4	p055160040pa		5.3	11	0.5	p053110050pr
	5.5	19	1	p055190100pa		5.3	12	1	p053120100pr
	6.5	12	0.5	p065120050pa		6.3	10	0.6	p063100060pr
	6.5	12	1	p065120100pa		6.3	12	0.5	p063120050pr
PV	4.2	7	0.5	p042070050pv		6.4	11	1.6	p064110160pr
	5	11	2	p050110200pv		6.4	12	1	p064120100pr
PR	1.2	3	0.3	p012030030pr		7	14	1.5	p070140150pr
	1.5	3	0.5	p015030050pr		8.2	15	1	p082150100pr
	1.6	6	0.5	p016060050pr		9	12	0.3	p090120030pr
	1.8	3	0.5	p018030050pr		9.2	11.6	0.3	p092116030pr
	1.8	4	0.5	p018040050pr		10	21	1	p100210100pr
	1.8	4.5	0.5	p018045050pr		12.5	19	1	p125190100pr
	2.2	4	0.5	p022040050pr		14.2	24.8	1	p142248100pr
	2.4	5	0.5	p024050050pr	RF	3.1	5.05	0.3	p03105003080
	2.5	5	0.5	p025050050pr		3.2	6	0.5	p03206005080
	2.5	8	0.8	p025080080pr		3.2	10	1	p03210010080
	2.8	4.5	0.5	p028045050pr		4.1	11	1	p04111010080
	2.8	5.5	0.3	p028055030pr		4.2	8	0.1	p04208001080
	2.8	5.5	0.5	p028055050pr		4.2	8	1	p04208010080
	2.8	6.5	0.5	p028065050pr		5.3	8	0.1	p05308001080
	2.8	7	0.5	p028070050pr		5.3	8	0.2	p05308002080
	3.2	5	0.5	p032050050pr		5.6	8	0.4	p05608004080
	3.2	6	0.5	p032060050pr		6.2	12	0.2	p06212002080
	3.2	6	0.8	p032060080pr		12	17	0.5	p12017005080
	3.2	6	1.5	p032060150pr		13.7	24	0.5	p13724005080
	3.2	7	1	p032070100pr	16	28	1.5	p16028015080	
3.2	7	2	p032070200pr	ST	1.8	4	0.3	p0180400309■	
3.2	8	0.5	p032080050pr		1.8	4.5	0.3	p0180450309■	
3.2	8	1	p032080100pr		2.1	5	0.5	p0210500509■	
3.2	8	1.5	p032080150pr		2.2	4.5	0.5	p0220450509■	
3.5	7	0.5	p035070050pr		2.2	5.5	0.5	p0220550509■	
3.7	7	0.8	p037070080pr		2.5	6	0.5	p0250600509■	

Andere Abmessungen auf Anfrage

Autres dimensions sur demande

Further dimensions on request



Verbindungstechnik

Scheiben Rondelles Washers

Werkstoff Matière Material	øD mm	øD1 mm	S mm	Artikelnummer Numéro d'article Part-No.	Werkstoff Matière Material	øD mm	øD1 mm	S mm	Artikelnummer Numéro d'article Part-No.
	2.7	6	0.5	p0270600509		5.3	10	0.5	p0531000509
	2.8	5.5	0.5	p0280550509		5.3	10	0.8	p0531000809
	2.8	6.5	2	p0280652009		5.3	10	1	p0531001009
	2.8	7	0.4	p0280700409		5.3	11	0.5	p0531100509
	2.8	7	0.5	p0280700509		5.3	11	1	p0531101009
	3.2	5	0.5	p0320500509		5.3	12	0.5	p0531200509
	3.2	5.6	0.3	p0320560309		5.3	12	1	p0531201009
	3.2	6	0.5	p0320600509		6.2	10	0.3	p0621000309
	3.2	6	0.8	p0320600809		6.2	12	1	p0621201009
	3.2	7	0.5	p0320700509		6.3	8	0.5	p0630800509
	3.2	7	1.5	p0320701509		6.3	9	0.5	p0630900509
	3.2	8	0.5	p0320800509		6.4	10	0.8	p0641000809
	3.2	8	1.2	p0320801209		6.4	14	1	p0641401009
	3.2	8	1.5	p0320801509		6.4	14	1.5	p0641401509
	3.2	9	0.5	p0320900509		7.2	12	0.3	p0721200309
	3.2	9	1	p0320901009		8	11	1	p0801101009
	3.2	10	0.8	p0321000809		8	14	0.8	p0801400809
	3.2	10	1	p0321001009		8.1	10.8	0.5	p0811080509
	3.7	6	0.5	p0370600509		8.1	12	0.2	p0811200209
	3.7	7	0.5	p0370700509		9	11.5	0.5	p0901150509
	3.7	8	0.5	p0370800509		9.2	13	1.6	p0921301609
	4.1	7	0.7	p0410700709		9.2	13	2	p0921302009
	4.15	11	1	p0411101009		9.5	12	0.5	p0951200509
	4.2	6	0.5	p0420600509		10	15	0.5	p1001500509
	4.2	7	0.5	p0420700509		10	21	1	p1002101009
	4.2	8	0.5	p0420800509		13	21	0.3	p1302100309
	4.2	8	0.8	p0420800809		13	21	0.5	p1302100509
	4.2	8	1.2	p0420801209		16.5	25	0.8	p1652500809
	4.2	9	0.5	p0420900509		18	24	2	p1802402009
	4.2	9	0.8	p0420900809		32.1	37	1.5	p3213701509
	4.2	10	0.5	p0421000509	TF	2.8	4.5	0.5	p028045050tf
	4.2	10	0.8	p0421000809		3	5	0.1	p030050010tf
	4.2	14	1.5	p0421401509		3	5	0.5	p030050050tf
	4.6	7	0.6	p0460700609		6	16	1	p060160100tf
	5	11	1	p0501101009		6.2	20	1	p062200100tf
	5.3	8	0.2	p0530800209					
	5.3	8	0.5	p0530800509					

Andere Abmessungen auf Anfrage

Autres dimensions sur demande

Further dimensions on request

KLINKMANN

www.klinkmann.com

Helsinki

tel. +358 9 540 4940
automation@klinkmann.fi

Yekaterinburg

tel. +7 343 287 19 19
yekaterinburg@klinkmann.spb.ru

Vilnius

tel. +370 5 215 1646
post@klinkmann.lt

St. Petersburg

tel. +7 812 327 3752
klinkmann@klinkmann.spb.ru

Samara

tel. +7 846 273 95 85
samara@klinkmann.spb.ru

Tallinn

tel. +372 668 4500
klinkmann.est@klinkmann.ee

Moscow

tel. +7 495 641 1616
moscow@klinkmann.spb.ru

Kiev

tel. +38 044 495 33 40
klinkmann@klinkmann.kiev.ua

Minsk

tel. +375 17 200 0876
minsk@klinkmann.com

Riga

tel. +371 6738 1617
klinkmann@klinkmann.lv