

SELECTION GUIDE

Essential Components

Get the right components, at the right price, right when you need them.



Klinkmann Finland & Baltics



Allen-Bradley

by ROCKWELL AUTOMATION

Why Choose Rockwell Automation?

Get the right components, at the right price, right when you need them.



Rockwell Automation offers quality Allen-Bradley® industrial components with 115 years of time-tested quality and durability. This catalog is your initial guide to selecting the best components to meet your specific application requirements. Throughout the book we have included resources to help you learn more and contact our local experts.

With Allen-Bradley components, you will find the highest quality at a fair price, an intuitive product selection, quick turnaround time and fast delivery. Additionally, you will get components that perform to your specifications, with the services and support you demand.



Looking for More?

This catalog highlights only our most essential components. For a complete product selection, visit our product directory at <https://rok.auto/directory>

Choose Innovation and Excellence

Rely on Award-Winning Products

Order and install with confidence. Don't just take our word for it. Year after year, Allen-Bradley industrial component products are ranked best in category by your peers. Our winners include:



Reader's Choice awards:

- Sequential logic control
- PLC programming
- Operator interface terminals
- Panel displays
- Electric motor drives
- Input/output systems



Automation World recognized Rockwell Automation as an outstanding supplier in the following categories in 2021:

- Drives
- HMI hardware
- PLCs/PACs
- Machine safety
- MES/MOM software
- Process control software



Control Engineering's 34th Annual Engineers' Choice Awards

Winners:

- Network integration – ethernet hardware, switches
- Motion control
- Process control systems

Honorable Mentions:

- Motion Control – Drives
- Software – Asset Management, reporting
- IIoT Connectivity – software
- Motion Control – Drives, Servo
- Software – Control design

Innovation Awards

"Our PEOPLE are the foundation of all we do, and creating an environment where everyone can do their best work is fundamental to our success."

- Blake Moret,
President and
Chief Executive Officer



World's Most Ethical Companies List

For the thirteenth time, the Ethisphere Institute has named Rockwell Automation as one of the "World's Most Ethical (WME) Companies," a recognition that honors organizations that continue to raise the bar on ethical leadership and corporate behavior.

The Ethisphere Institute is an independent center of research promoting best practices in corporate ethics and governance. World's Most Ethical Company honorees understand the correlation between ethics, reputation and daily interactions.



Rockwell Automation Services

Minimizing Risk. Maximizing Productivity.



Workforce support & training

- Remediate
- Enable
- Supplement
- Optimize



People & asset safety

- Hazardous energy control
- Machine safety



Asset & plant optimization

- Inventory services
- Asset modernization
- Asset performance

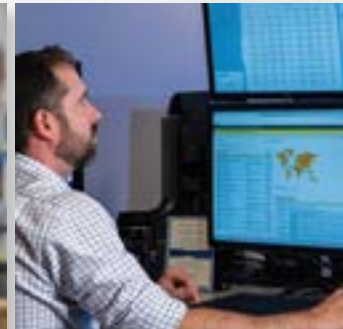

Information infrastructure & security

- Infrastructure development and management
- Asset performance

Product & application lifecycle support



On-demand support

| Integrated support

| Managed support



For more information about how we can help you solve your unique business challenges, contact your local authorized Allen-Bradley distributor or Rockwell Automation sales office, or visit: rok.auto/services



Support

Visit the Rockwell Automation support website for more information on all our offerings.

<https://rok.auto/support>



Online Resources

Rockwell Automation offers a wide range of online tools to assist you in selecting and configuring your application.



Literature Library

Browse Literature Library for technical and commercial publications in multiple languages.

- Application Guides
- User Manuals
- Brochures
- White Papers
- Instruction Sheets



<https://rok.auto/library>

Select, Design and Configure

Browse our diverse collection of tools designed to help you choose the right products, and plan and configure a system to support your business needs.

- Accelerator Toolkits
- System Configuration
- Product Drawings
- Product Certifications
- Product Selection



<https://rok.auto/selection>

Drivers, Software and Downloads

Get access to all the latest resources to support your application.

- Drivers
- Software Downloads
- Firmware Updates
- Software Activations and Transfers
- Network Resources



<https://rok.auto/downloads>



ROK Talk Podcasts

Stay up to date with the latest in Allen-Bradley products.

<https://rok.auto/roktalk-industrial-components>

<https://rok.auto/roktalk-safety-sensing-connectivity>

<https://rok.auto/roktalk-drives>



Looking for More?

This catalog highlights only our most essential components. For a complete product selection, visit our online product directory at

<https://rok.auto/directory>

ESSENTIAL COMPONENTS - TABLE OF CONTENTS

✦ Denotes new product offering

Smart Devices	0-6	Smart Devices 0-6
		Smart Sensing and Industrial Control..... 0-8
		Smart Safety 0-10
		Circuit Breakers ✦ 1-2
		Disconnect Switches 1-16
		Control & Load Switches 1-24
		Contactors ✦ 1-28
		Starters..... 1-42
		Motor Protection ✦ 1-56
		Smart Motor Control 1-62
		Drives..... 1-72
		Additional Power Products ✦ 1-78
Power	1-1	
		Relays & Timers ✦ 2-2
		Programmable Controllers..... 2-20
		Control Circuit & Load Protection ✦ 2-24
		Power Supplies..... ✦ 2-36
		Power Quality & Energy Management 2-44
		Surge & Filter 2-46
		Additional Logic Products 2-50
Logic	2-1	
		Push Buttons..... 3-2
		Signaling ✦ 3-24
		Graphic Terminals..... 3-36
		Additional Operator Interface Products 3-38
Operator Interface	3-1	
		Terminal Blocks..... ✦ 4-2
		Wiring Systems 4-34
		Signal Interface 4-36
		Connection Systems..... 4-40
		Safety Connection Systems 4-50
		Network Media 4-54
		Additional Connectivity Products..... 4-62
Connectivity	4-1	
		GuardLink..... 5-2
		Presence Sensing Safety Devices ✦ 5-4
		Interlock Switches..... ✦ 5-20
		Access Control 5-40
		Safety Relays..... 5-42
		Emergency Stop Devices 5-48
		Safety Limit Switches..... 5-50
		Additional Safety Products ✦ 5-52
Safety	5-1	
		Photoelectric Sensors ✦ 6-2
		Proximity Sensors ✦ 6-48
		Ultrasonic Sensors ✦ 6-78
		Limit Switches 6-82
		Encoders..... ✦ 6-94
		Condition Sensing ✦ 6-101
		RFID ✦ 6-112
		Additional Sensor Products 6-116
Sensors	6-1	

SMART DEVICES



Smart Devices	
Smart Devices.....	0-6
Smart Devices.....	0-14
Smart Sensing and Industrial Control	
Smart Sensing and Industrial Control.....	0-8
Smart Safety	
Smart Safety	0-10

Smart Devices

Make your machines and equipment smarter

Smart Devices are the core of modern automation, which expand what's possible and is a catalyst that makes you more productive and more connected.

Allen-Bradley® Smart Devices deliver information and insights that enable predictive maintenance, speed troubleshooting, reduce downtime – and maximize ROI. Scalable Smart Devices lay the foundation for smarter machines, smart connected systems and knowledge-driven operations.

Real-time data

Current, voltage, kWh, running time, temperature, safety

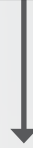

Information

CONTEXTUALIZATION
Production output, warnings/alarms, energy usage, downtime causals

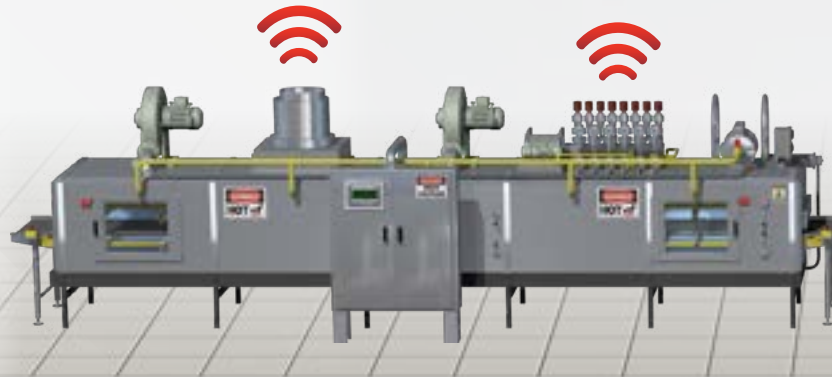

Our Smart Devices include:

Variable Frequency Drives



Servo Drives



Motor Starters



Condition Monitoring





Knowledge
ANALYTICS
Mean time to repair,
predictive maintenance, OEE

Optimize
ACTION
More efficient process workflows,
continuous improvement



Power Monitoring



Motor Protection



Sensors



Safety



Smart Sensing and Industrial Control

Our Integrated Smart Sensing and Industrial Control Solution

When it comes to linking end point devices on the plant floor to The Connected Enterprise, Rockwell Automation offers a wide range of smart sensing and industrial control products that deliver information, advanced functionality and flexibility while increasing efficiency machine- and plant-wide. These Allen-Bradley® sensors and industrial control products use IO-Link technology for visibility of field devices through your Integrated Architecture.

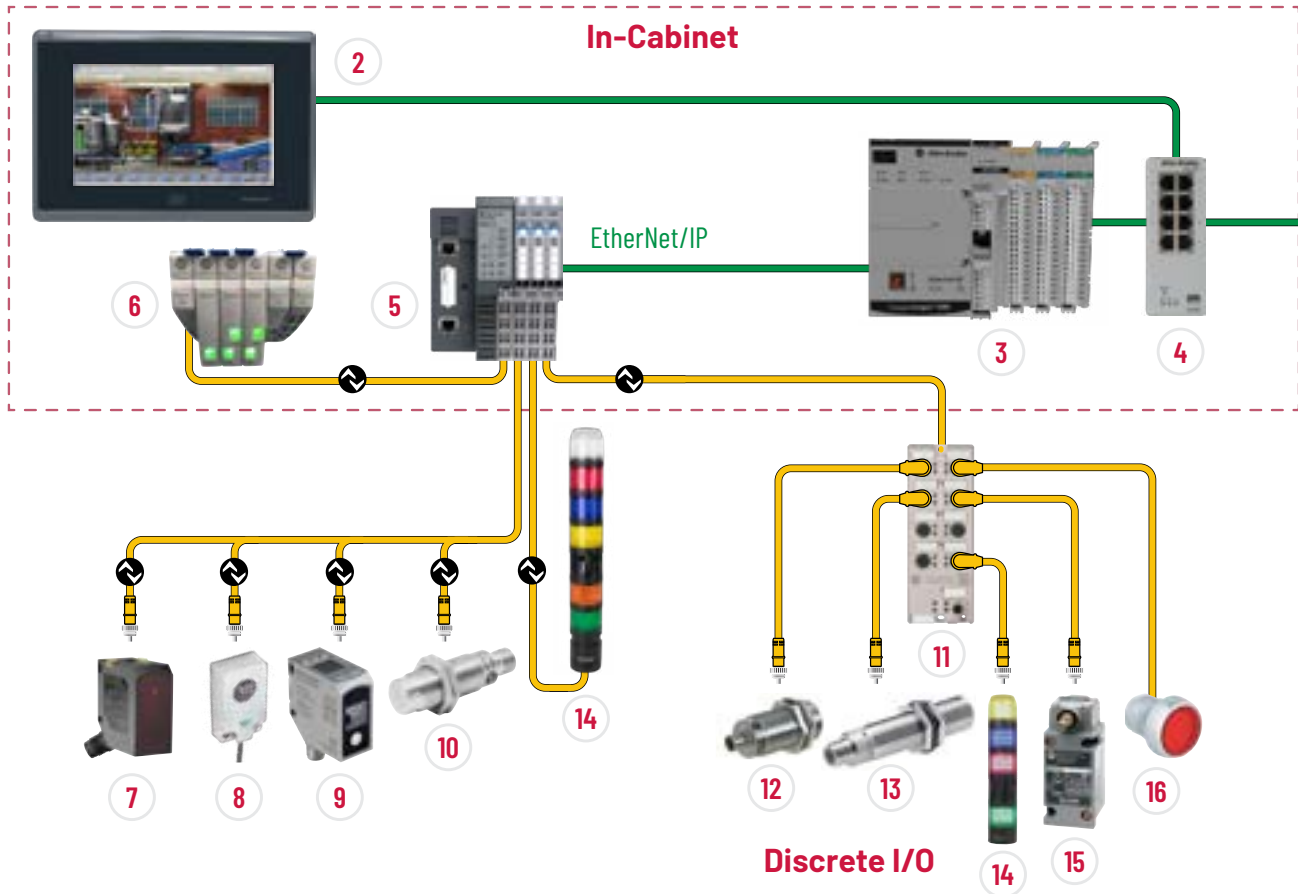

Item Number	Description
2	PanelView™ 5510
3	CompactLogix™ 5380
4	Stratix Switch
5	1734-4IOL Point I/O IO-Link Master
6	1694 Electronic Circuit Protector
7	45DMS Distance Measurement Sensor
8	871FM Mini Flat Pack Proximity Sensor
9	46CLR ColorSight™ True Color Sensor

Item Number	Description
10	871TM Tubular Stainless Steel Sensor
11	ArmorBlock IO-Link Hub
12	872C WorldProx™ Tubular General Purpose Inductive Proximity Sensor
13	871C Tubular Extended Temperature Sensor
14	856T Control Tower™ Stack Lights
15	802T Oiltight Limit Switch
16	800F 22 mm Round Operator

Smart Sensing & Industrial Control

EtherNet/IP®



0-8...0-9

GuardLink



0-10...0-11

CIP Safety

EtherNet/IP®



0-12...0-13

What is IO-Link?

IO-Link is a worldwide open-standard peer-to-peer serial communication protocol (IEC 61131-9) that allows sensors and actuators to easily integrate into The Connected Enterprise. Through IO-Link you can access all sensor configuration parameters, process data and diagnostics. So you can go beyond detecting products on your machine - now you can MONITOR your machine's health as it runs. Plus, IO-Link simplifies setup and commissioning while offering enhanced flexibility for current - and future - processes.

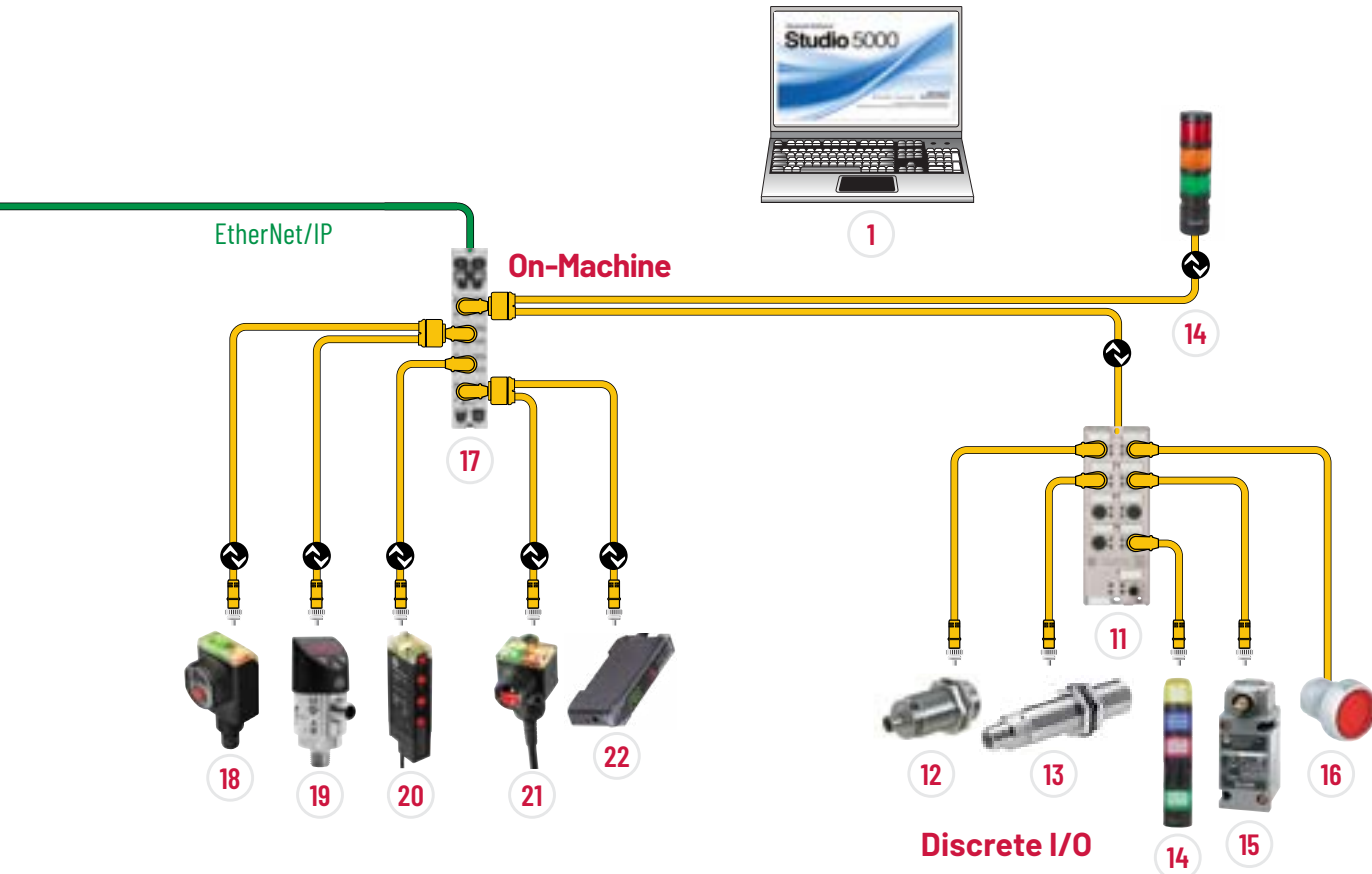

Item Number	Description
1	Studio 5000®
11	ArmorBlock IO-Link Hub
12	872C WorldProx™ Tubular General Purpose Inductive Proximity Sensor
13	871C Tubular Extended Temperature Sensor
14	856T Control Tower™ Stack Lights
15	802T Oiltight Limit Switch

Item Number	Description
16	800F 22 mm Round Operator
17	1732-E8IOLM12R ArmorBlock IO-Link Master
18	42AF RightSight™ M30 Sensor
19	836P Solid-State Pressure Sensor
20	45PLA Polarized Light Array Photoelectric Sensor
21	42EF RightSight™ Sensor
22	46DFA DIN Rail Fiber Optic Amplifier

 Look for this symbol for IO-Link enabled Smart Devices

For more information on our Smart Device products, please visit:
<https://rok.auto/smart-devices>



Smart Safety

Smart Safety Technology

Rockwell Automation smart safety products enhance safety while providing connectivity through The Connected Enterprise. Allen-Bradley Guardmaster® smart safety devices featuring EtherNet/IP connectivity or GuardLink® enabling technology deliver information, diagnostics, advanced functionality and flexibility, while enhancing safety and increasing efficiency machine- and plant-wide.

THE CONNECTED ENTERPRISE/INDUSTRY 4.0

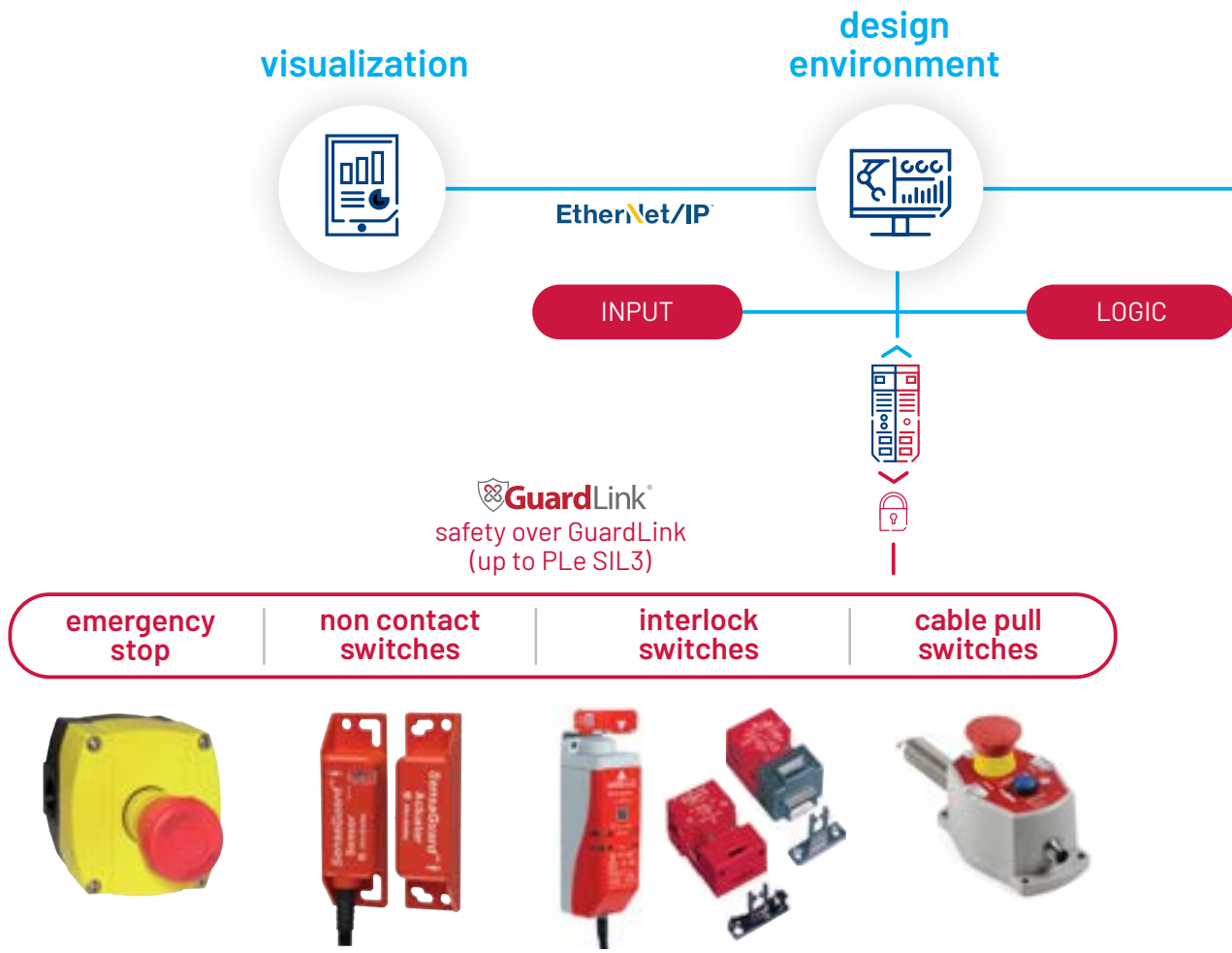

Cable reduction of up to 38%

Smart Sensing & Industrial Control

EtherNet/IP



0-8...0-9

GuardLink

GuardLink

0-10...0-11

CIP Safety

EtherNet/IP



0-12...0-13

Smart safety solutions provide detailed diagnostic data to your design environment, visualization system, information software and GuardLogix® Programmable Automation Controller - enabling Smart Machines for Smart Manufacturing and helping to increase productivity and minimize downtime while reducing total cost of ownership.

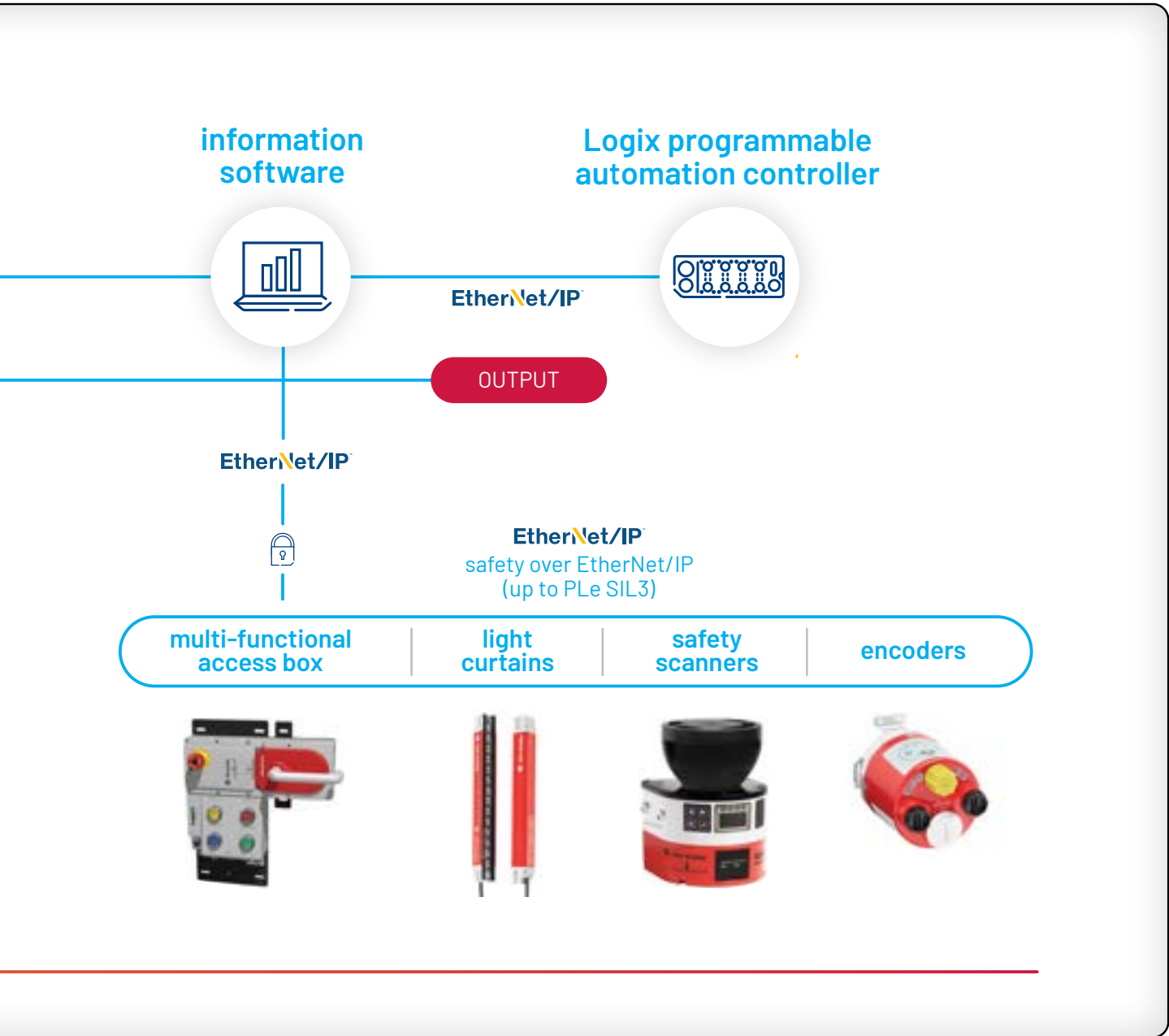

multi-functional access box



light curtains



safety scanners



encoders



Smart Safety

EtherNet/IP®



CIP Safety over EtherNet/IP™ connectivity

SMART DEVICES

440G-MZ Guard Locking Interlock Switch

Guard Locking Switches lock/unlock signals can be provided, giving the devices current state and specific location within the system. Individual indication of the guard doors state including guard open, guard closed, guard locked or guard unlocked can also be provided.



450L Light Curtains

450L Light curtains can be connected simply to GuardLink via a GuardLink enabled tap. Access to the light curtains status along with the location can be communicated.



Lifeline 5

Connect a Lifeline™ 5 Cable Pull Switch to get the location of the device and rope tension status to avoid nuisance trips from occurring when operated.



GuardLink Enabled Tap Indication

LED Input Indicator

Green = Connected input device healthy
 Flashing Green = Connected input device healthy but fault on system
 Red = Trip on connected input device
 Flashing Red = Connected input device has not performed correctly

LED Link Indicator

Green = Operational
 Red = Tripped
 Flashing Red = Faulty tap



Smart Sensing & Industrial Control

EtherNet/IP®



0-8...0-9

GuardLink

GuardLink

0-10...0-11

CIP Safety

EtherNet/IP®



0-12...0-13

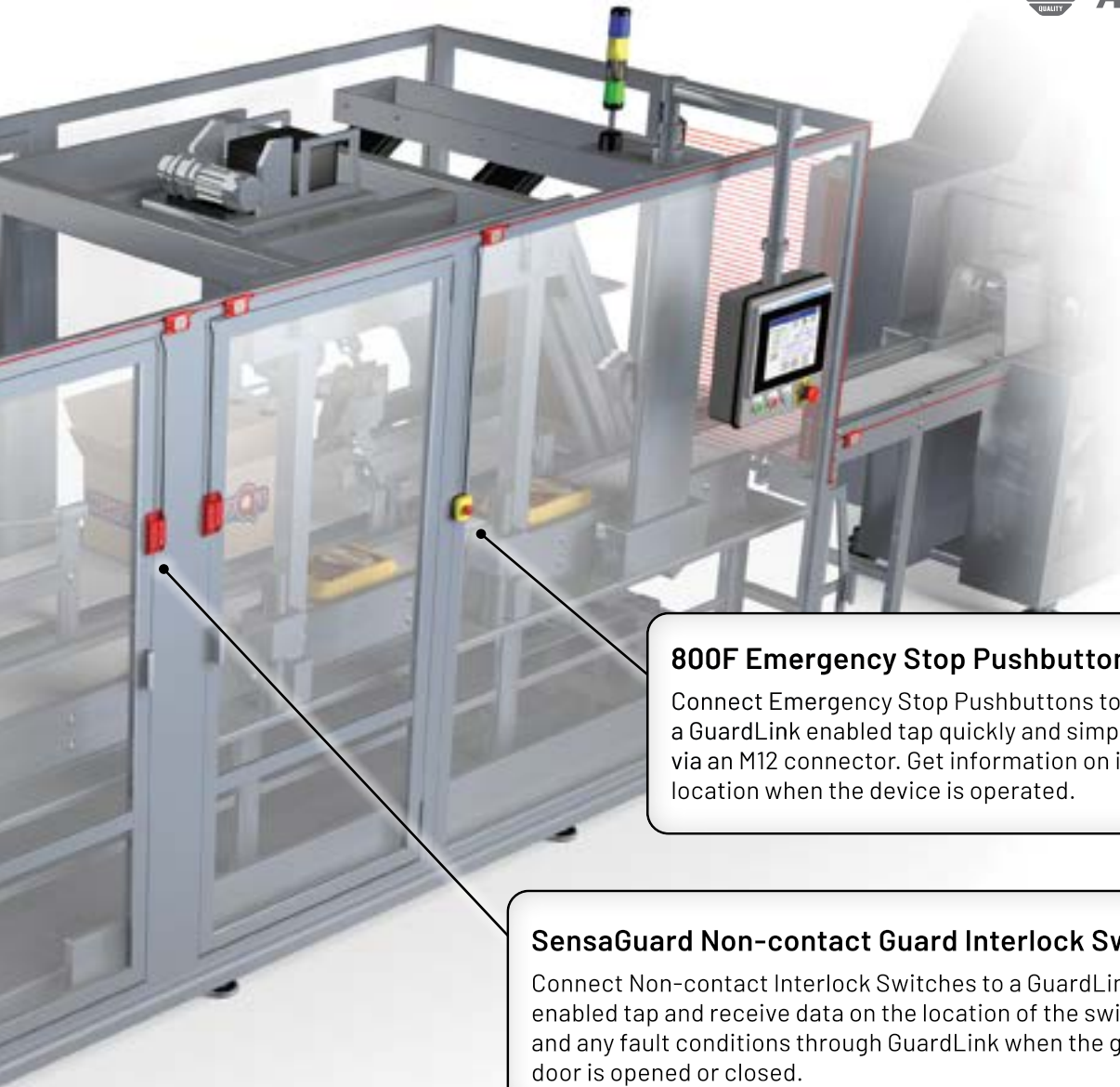

800F Emergency Stop Pushbutton

Connect Emergency Stop Pushbuttons to a GuardLink enabled tap quickly and simply via an M12 connector. Get information on its location when the device is operated.



SensaGuard Non-contact Guard Interlock Switch

Connect Non-contact Interlock Switches to a GuardLink enabled tap and receive data on the location of the switch and any fault conditions through GuardLink when the guard door is opened or closed.



GSR DG - Dual GuardLink Safety Relay

The GSR DG - Dual GuardLink Safety Relay can monitor two GuardLink channels and communicate status information for each safety input device via the EtherNet/IP Network Interface.



Smart Manufacturing Delivers Measurable Results

Improve safety, increase quality and optimize plant performance

Thanks to constant evolution of technology, resulting in free flowing/open connectivity coupled to modern automation solutions, smart manufacturing has morphed from an abstract concept into a technological reality – and is now, arguably, an engineering necessity!

Modern market forces demand levels of flexibility, agility and overall operational equipment effectiveness (OEE) that only smart solutions can deliver. Are you keeping pace?

Many contemporary business outcomes – like reducing downtime – are based around knowledge-driven operations and smart, flexible manufacturing. But what is smart?

How do you get smart? Are you already smart? And what will being smart deliver?

Smart Devices provide the foundation for a digital transformation, Smart Machines provide unsurpassed level of intelligence to drive productivity and Smart Systems enable knowledge-driven operations.

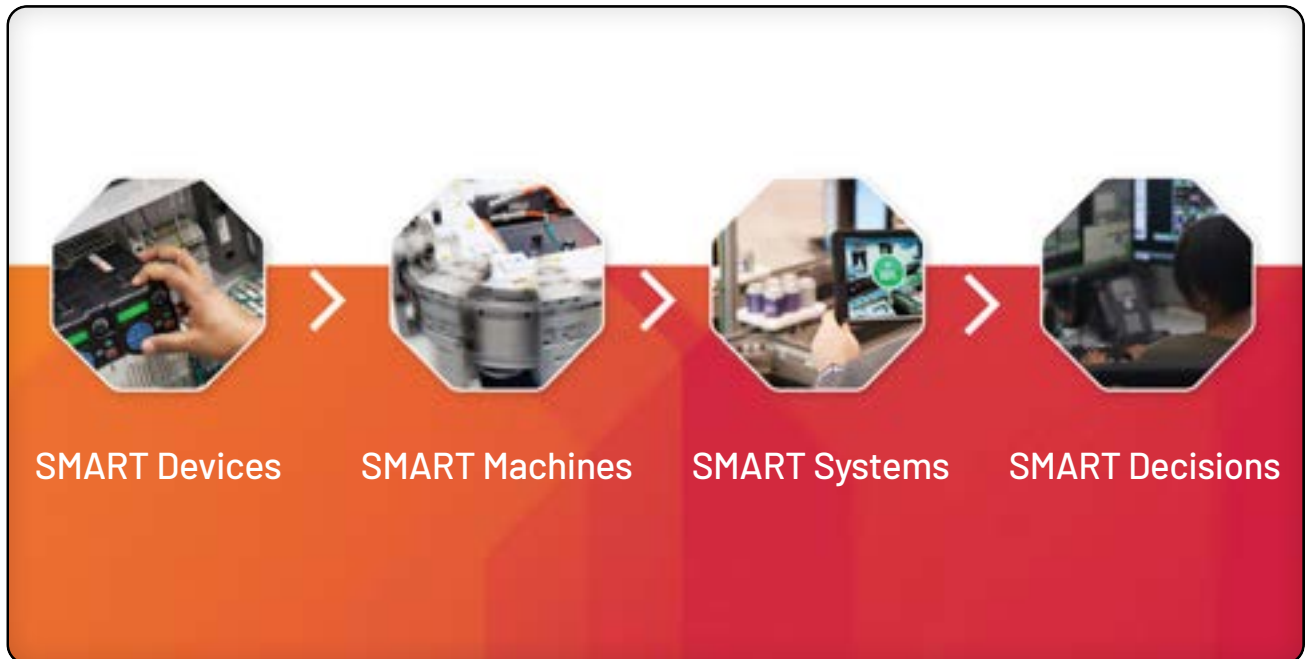

POWER

Circuit Breakers

Motor Circuit Protectors.....	1-3
Motor Protection Circuit Breakers	1-3
Molded Case Circuit Breakers	1-3

Disconnect Switches

Rotary Disconnect Switches.....	1-16
Visible Blade Disconnect Switches	1-20

Control & Load Switches

Control & Load Switches	1-24
Load Switches	1-26

Contactors

IEC Contactors.....	1-28
Safety Contactors	1-36
Definite Purpose Contactors	1-40

Starters

Manual Motor Starters	1-42
Open Starters, IEC.....	1-44
Enclosed Starters, IEC	1-46
Combination Starters, IEC.....	1-48
Open Starters, NEMA.....	1-50
Combination Starters, NEMA.....	1-54

Motor Protection

Bimetallic Overload Relays.....	1-56
Electronic Overload Relays	1-58

Smart Motor Control

Solid-State Contactors.....	1-62
Starting Torque Controller	1-64
SMC Smart Motor Controllers	1-66

Drives

PowerFlex Drives.....	1-72
-----------------------	------

Additional Power Products.....

	1-78
--	------

Circuit Breakers

Applying Circuit Protection

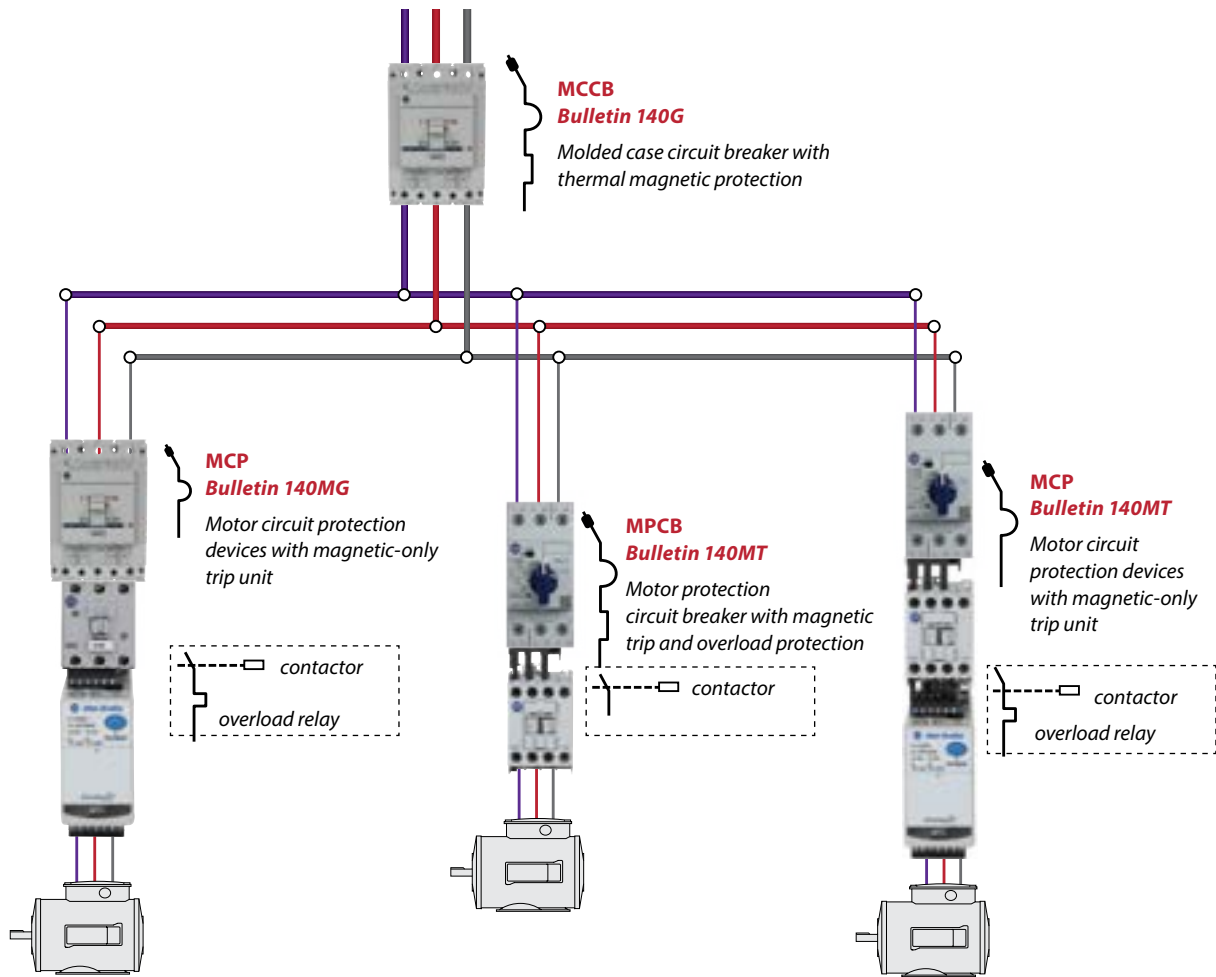

Molded Case Circuit Breakers (MCCB) are designed to protect an electrical circuit from damage caused by overload or short circuit. Their basic function is to detect a fault condition and interrupt current flow. An MCCB can be reset (either manually or automatically) to resume normal operation.

Motor Circuit Protectors (MCP) are designed to provide short circuit (magnetic) protection and disconnect for a motor circuit. They are designed to be used with a contactor (to start/stop the motor) and an overload relay (to protect against overcurrent).

Motor Protection Circuit Breakers (MPCB) are designed to provide short circuit (magnetic) protection, a disconnect for motor circuit, and overload protection for the motor, all in one device.

Circuit Breakers



1-2...1-15

Disconnect Switches



1-16...1-23

Control & Load Switches



1-24...1-27

Contactors



1-28...1-41

Starters



1-42...1-55

Motor Protection



1-56...1-61





Smart Motor Control



1-62...1-71

Product Selection

140MP, 140MT, 140MG (Various Frames)

					
Bulletin No.	140MP-A	140MT-C	140MT-D	140MG	140MG
Frame Size	-	C-Frame	D-Frame	H-Frame	J-Frame
Dimensions (mm)	45x90x85.5(1)	45x96x84	45x96x94	130(5.19)x90(3.54) x82.5(3.25)	160(6.23)x105(4.13) x82.5(3.25)
Current Range (A)	0.1 - 32	0.1 - 32	0.4 - 40	25, 60, 100 adj from 0.4 to 1xIn	40, 60 100, 150 adj from 0.4 to 1.0 In
SCCR @ 480V (kA)	18-30	30-65	30-50-65	65	65
SCCR @ 400V (kA)	15-50-100	15-65-100	50-65-100	65	65
Short Cir. Protection	X	X	X	X	X
Overload Protection	X	X	X	X	X
Overload Trip Class	10A	10	10	3E, 5E, 10E, 20E	3E, 5E, 10E, 20E
Phase Loss Sensitivity	X	X	X	X	X
Short Circuit Indication	-	X	X	X	X
Lockable knob	Optional	Optional	Standard	Toggle	Toggle
Compatible at output of VFD	-	-	X	-	-
MCP Version, High Inrush version	-	-	X	-	-

UL 60947-4-1 Application Ratings

Motor Disc. Rated	X	X	X	X	X
Group Motor Rated	X	X	X	-	-
Tap Conductor Protection	-	X	X	X	X
Man/Self Protected (Type E)	-	X	X	-	-
UL Type F Ratings	-	100-C, 100-E, 100-K	100-C, 100-E, 100-K	-	-

Standards Compliance and Certifications

cULus Listing (3)	X	X	X	X	X
IEC/EN 60947-2	X	X	X	X	X
IEC/EN 60947-4-1	X	X	X	X	X
CE	X	X	X	X	X
ATEX	-	X	X	-	-
IECEX	-	X	X	-	-
EAC	X	X	X	X	X
CCC	X	X	X	X	X
KC	X	-	-	-	-
CB Scheme	X	X	X	-	-

Drives



1-72...1-77

For more information on our complete family of circuit protection products, please visit:
<https://rok.auto/circuit-load-protection>



Circuit Breakers



Product Selection

140MT Motor Circuit Protectors

POWER

Rated Operational Current (I_n) [A]	Motor Current Adjustment Range [A]	Nominal Magnetic Trip Current [A]	Max Short-circuit Current [kA]		Max. 3-phase Hp Ratings ¹				Max. kW, 3-Phase - AC-3 ¹				Cat. No.
			400V (I_{cu})	480V (group motor)	200V	230V	460V	575V	230V	400/415V	500V	690V	
D-Frame, Fixed Magnetic (14 x I_n)													
0.16	–	2.2	100	65	–	–	–	–	–	0.02	0.06	0.06	140MT-D9N-A16
0.25	–	3.5	100	65	–	–	–	–	–	0.04	0.09	0.09	140MT-D9N-A25
0.4	–	5.6	100	65	–	–	–	–	0.06	0.09	0.12	0.18	140MT-D9N-A40
0.63	–	8.8	100	65	–	–	–	–	0.09	0.18	0.18	0.25	140MT-D9N-A63
1	–	14	100	65	–	–	0.5	0.5	0.18	0.25	0.37	0.55	140MT-D9N-B10
1.6	–	22	100	65	0.25	0.33	0.75	0.75	0.25	0.55	0.75	1.1	140MT-D9N-B16
2.5	–	35	100	65	0.5	0.5	1	1.5	0.37	0.75	1.1	1.8	140MT-D9N-B25
4	–	56	100	65	0.75	0.75	2	3	0.75	1.5	2.2	3	140MT-D9N-B40
6.3	–	88	100	65	1	1.5	3	5	1.5	2.2	3	4	140MT-D9N-B63
10	–	140	100	65	2	3	5	7.5	2.2	4	6.3	7.5	140MT-D9N-C10
16	–	224	100	65	3	5	10	10	4	7.5	10	13	140MT-D9N-C16
20	–	280	100	65	5	5	10	15	5.5	10	11	17	140MT-D9N-C20
25	–	350	65	50	7.5	7.5	15	20	5.5	11	15	22	140MT-D9N-C25
29	–	406	50	50	7.5	10	20	25	7.5	13	18.5	25	140MT-D9N-C29
32	–	448	50	50	7.5	10	20	30	7.5	15	20	25	140MT-D9N-C32
36	–	432	50	30	10	10	25	30	–	18.5	20	25	140MT-D9N-C36 ²
40	–	480	50	30	10	10	30	30	11	20	24	30	140MT-D9N-C40 ²
F-Frame, Fixed Magnetic (13 x I_n)													
25	–	325	100	65	7.5	10	20	25	6.3	11	15	22	140M-F8N-C25
32	–	416	65	65	7.5	10	25	30	7.5	15	20	30	140M-F8N-C32
45	–	585	65	65	10	15	30	40	13	22	30	40	140M-F8N-C45

¹ Horsepower/kW ratings shown are for reference. The final selection of the MCP depends on the actual motor full load current.

² Suitable for continuous operation at 90% current rating at 480V only if used in a minimum enclosure size of 250 x 175 x 150 mm (10 x 7 x 6 in).

See technical data for de-rating for Trip class 20 and 30 applications.

Circuit Breakers



1-2...1-15

Disconnect Switches



1-16...1-23

Control & Load Switches



1-24...1-27

Contactors



1-28...1-41

Starters



1-42...1-55

Motor Protection



1-56...1-61

Smart Motor Control



1-62...1-71



Product Selection

140MP Motor Protective Switching Devices

Rated Operational Current (I_r) [A]	Motor Current Adjustment Range [A]	Nominal Magnetic Trip Current [A]	Max Short-circuit Current [kA]		Max. 3-phase Hp Ratings ¹				Max. kW, 3-Phase - AC-3 ¹				Cat. No.
			400V (I_{cu})	480V (group motor)	200V	230V	460V	575V	230V	400/415V	500V	690V	
0.16	0.10...0.16	2	100	30	—	—	—	—	—	0.02	0.06	0.06	140MP-A3E-A16
0.25	0.16...0.25	3.1	100	30	—	—	—	—	—	0.04	0.09	0.09	140MP-A3E-A25
0.4	0.25...0.40	5	100	30	—	—	—	0.25	0.06	0.09	0.12	0.18	140MP-A3E-A40
0.63	0.40...0.63	7.9	100	30	—	—	0.25	0.33	0.09	0.18	0.18	0.25	140MP-A3E-A63
1	0.63...1.0	12.5	100	30	—	—	0.5	0.75	0.18	0.25	0.37	0.55	140MP-A3E-B10
1.6	1.0...1.6	20	100	30	0.25	0.33	1	1	0.25	0.55	0.75	1.1	140MP-A3E-B16
2.5	1.6...2.5	31.3	75	30	0.5	0.75	1.5	2	0.37	0.75	1.1	1.8	140MP-A3E-B25
4	2.5...4.0	50	75	18	1	1	3	3	0.75	1.5	2.2	3	140MP-A3E-B40
6.3	4.0...6.3	78.8	50	18	1.5	2	5	5	1.5	2.2	3	4	140MP-A3E-B63
10	6.3...10	150	50	18	3	3	7.5	10	2.2	4	6.3	7.5	140MP-A3E-C10
12	8.0...12	180	50	18	3	3	7.5	10	3	5.5	6.3	7.5	140MP-A3E-C12
16	10...16	240	15	18	5	5	10	15	4	7.5	10	13	140MP-A3E-C16
20	16...20	300	15	18	5	7.5	15	20	5.5	10	11	17	140MP-A3E-C20
25	20...25	375	15	18	7.5	7.5	20	20	5.5	11	15	22	140MP-A3E-C25
32	25...32	480	15	18	7.5	10	25	30	7.5	15	20	25	140MP-A3E-C32

140MT Motor Protective Switching Devices

Rated Operational Current (I_r) [A]	Motor Current Adjustment Range [A]	Nominal Magnetic Trip Current [A]	Max Short-circuit Current [kA]		Max. 3-phase Hp Ratings ¹				Max. kW, 3-Phase - AC-3 ¹				Cat. No.
			400V (I_{cu})	480V (group motor)	200V	230V	460V	575V	230V	400/415V	500V	690V	
C-Frame, Adjustable Thermal/Fixed Magnetic (14 x I_n)													
0.16	0.10...0.16	2.2	100	65	—	—	—	—	—	0.02	0.06	0.06	140MT-C3E-A16
0.25	0.16...0.25	3.5	100	65	—	—	—	—	—	0.04	0.09	0.09	140MT-C3E-A25
0.4	0.25...0.40	5.6	100	65	—	—	—	—	0.06	0.09	0.12	0.18	140MT-C3E-A40
0.63	0.40...0.63	8.8	100	65	—	—	—	—	0.09	0.18	0.18	0.25	140MT-C3E-A63
1	0.63...1.0	14	100	65	—	—	0.5	0.5	0.18	0.25	0.37	0.55	140MT-C3E-B10
1.6	1.0...1.6	22	100	65	0.25	0.33	0.75	0.75	0.25	0.55	0.75	1.1	140MT-C3E-B16
2.5	1.6...2.5	35	100	65	0.5	0.5	1	1.5	0.37	0.75	1.1	1.8	140MT-C3E-B25
4	2.5...4.0	56	100	65	0.75	0.75	2	3	0.75	1.5	2.2	3	140MT-C3E-B40
6.3	4.0...6.3	88	100	65	1	1.5	3	5	1.5	2.2	3	4	140MT-C3E-B63
10	6.3...10	140	100	65	2	3	5	7.5	2.2	4	6.3	7.5	140MT-C3E-C10
16	10...16	224	65	30	3	5	10	10	4	7.5	10	13	140MT-C3E-C16
20	14.5...20	280	50	30	5	5	10	15	5.5	10	11	17	140MT-C3E-C20
25	18...25	350	15	30	7.5	7.5	15	20	5.5	11	15	22	140MT-C3E-C25
29	23...29	406	15	30	7.5	10	20	25	7.5	13	18.5	25	140MT-C3E-C29
32	26.5...32	448	15	30	7.5	10	20	30	7.5	15	20	25	140MT-C3E-C32

¹ Horsepower/kW ratings shown are for reference. The final selection of the MPCB/MPSD depends on the actual motor full load current.

Drives



For more information on our complete family of circuit protection products, please visit:
<https://rok.auto/circuit-load-protection>



Circuit Breakers

Product Selection

140MT Motor Protection Circuit Breaker for Multiple Motor Installation with Drives



POWER

Rated Operational Current (I_n) [A]	Motor Current Adjustment Range [A]	Nominal Magnetic Trip Current [A]	Max Short-circuit Current [kA]		Max. 3-phase Hp Ratings ¹				Max. kW, 3-Phase - AC-3 ¹				Cat. No.
			400V (I_{cu})	480V (group motor)	200V	230V	460V	575V	230V	400/415V	500V	690V	
D-Frame, Fixed Magnetic (application at output of VFD multi-motor)													
1.6	1.0...1.6	88	100	65	—	—	0.75	—	0.25	0.55	0.75	—	140MT-D9V-B16
2.5	1.6...2.5	88	100	65	0.5	0.5	1	—	0.37	0.75	1.1	—	140MT-D9V-B25
4	2.5...4.0	88	100	65	0.75	0.75	2	—	0.75	1.5	2.2	—	140MT-D9V-B40
6.3	4.0...6.3	88	100	65	1	1.5	3	—	1.5	2.2	3	—	140MT-D9V-B63
10	6.3...10	140	100	65	2	3	5	—	2.2	4	6.3	—	140MT-D9V-C10
16	10...16	224	100	65	3	5	10	—	4	7.5	10	—	140MT-D9V-C16
20	14.5...20	280	100	65	5	5	10	—	5.5	10	11	—	140MT-D9V-C20
25	18...25	350	65	50	7.5	7.5	15	—	5.5	11	15	—	140MT-D9V-C25
29	23...29	406	50	50	7.5	10	20	—	7.5	13	18.5	—	140MT-D9V-C29
32	26.5...32	448	50	50	7.5	10	20	—	7.5	15	20	—	140MT-D9V-C32
36	30...36	432	50	30	10	10	25	—	—	18.5	20	—	140MT-D9V-C36 ²
40	34...40	480	50	30	10	10	30	—	11	20	24	—	140MT-D9V-C40 ²

¹ Horsepower/kW ratings shown in the tables above are for reference. The final selection of the manual starter depends on the actual motor full load current.

² Suitable for continuous operation at 90% current rating at 480V only if used in a minimum enclosure size of 250 x 175 x 150 mm (10 x 7 x 6 in).

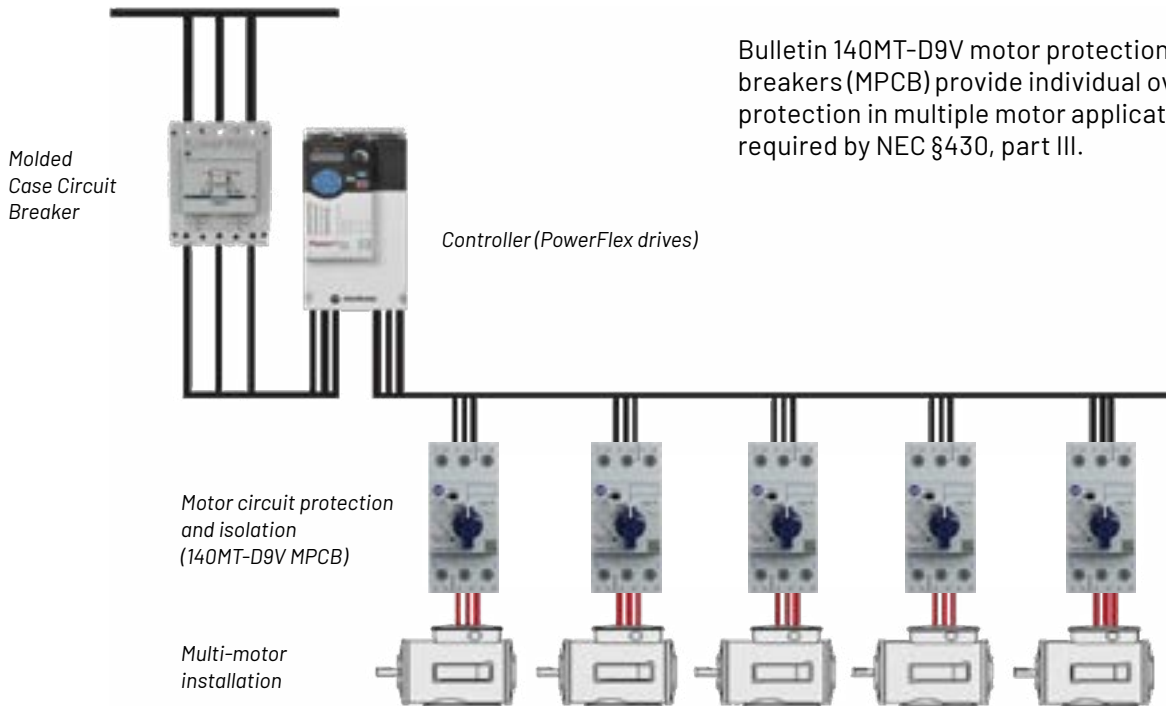

Circuit Breakers



1-2...1-15

Disconnect Switches



1-16...1-23

Control & Load Switches



1-24...1-27

Contactors



1-28...1-41

Starters



1-42...1-55

Motor Protection



1-56...1-61

Smart Motor Control



1-62...1-71



Product Selection

140MG Motor Circuit Protectors

Rated Operational Current (I_n) [A]	Magnetic Trip Current [A]	Ultimate Interrupting Current [kA]	Max. 3-phase Hp Ratings 1		Max. kW, 3-Phase - AC-3 1		Cat. No.
	CAM Setting Range		415V / I_{cu}	230V	460V	230V	
G-Frame							
3	12...33	5	0.5	1.5	0.6	0.75	140MG-G8P-B30
7	28...77	5	2	3	1.1	2.2	140MG-G8P-B70
H-Frame							
30	90...330	70	10	20	5.5	11	140MG-H8P-C30
50	150...550	70	15	30	11	22	140MG-H8P-C50
J-Frame							
100	600...1200	50	30	75	22	37	140MG-J8P-D10
110	660...1320	50	40	75	22	45	140MG-J8P-D11
175	875...1750	70	60	125	37	55	140MG-J8P-D17
200	1000...2000	70	75	150	45	75	140MG-J8P-D20

¹ Horsepower/kW ratings shown in the tables above are for reference. The final selection of the MCP depends on the actual motor full load current.



140MG Motor Protection Circuit Breakers

3-phase kW Ratings (50 Hz)	3-phase Hp Ratings (60Hz)		Max. Short-Circuit Current [kA]		L		U	I	Cat. No.
	400/415V	460V	575V	480V	600V	Motor Current Adjustment Range I_r [A]	Trip Class	50% of I_n	
H-Frame									
11	15	20	65	25	10...25	3E, 5E, 10E, 20E (approx. 2...20 s)	ON or OFF	Adjustable from 6...13 x I_n	140MG-H8E-C25
32	40	50	65	25	24...60				140MG-H8E-C60
55	75	100	65	25	40...100				140MG-H8E-D10
J-Frame									
22	30	40	65	25	16...40	3E, 5E, 10E, 20E (approx. 2...20 s)	ON or OFF	Adjustable from 6...13 x I_n	140MG-J8E-C40
32	40	50	65	25	24...60				140MG-J8E-C60
55	75	100	65	25	40...100				140MG-J8E-D10
80	100	150	65	25	60...150				140MG-J8E-D15

Drives



1-72...1-77

For more information on our complete family of circuit protection products, please visit:
<https://rok.auto/circuit-load-protection>



Circuit Breakers

Accessories

140MT Motor Circuit Protectors and 140MT Motor Protection Circuit Breakers

Auxiliary Contacts

Description	Auxiliary Contacts		For Use With	Cat. No.
	N.O.	N.C.		
Front-mounted	1	0	140MT-C, D	140MT-C-AFA10
	1	1		140MT-C-AFA11
	2	0		140MT-C-AFA20
Right Side-mounted	2	0	140MT-C, D	140MT-C-ASA20
	0	2		140MT-C-ASA02
	1	1		140MT-C-ASA11

Voltage Trip Units

Description	Trip Rating	For Use With	Cat. No.
Shunt trip	110V, 50 Hz / 120V, 60 Hz	140MT-C, D	140MT-C-SND
	230V, 50 Hz		140MT-C-SNF
	240...260V, 60 Hz		140MT-C-SNA
	24V DC		140MT-C-SNZJ
Undervoltage trip	110V, 50 Hz / 120V, 60 Hz	140MT-C, D	140MT-C-UXD
	230V, 50 Hz		140MT-C-UXF
	240...260V, 60 Hz		140MT-C-UXA
	480V, 60 Hz / 415V, 50 Hz		140MT-C-UXB

Handles

Description		For Use With	Cat. No.
Lockable Knob	Black	140MT-C, D	140MT-C-KN
Lockable Knob	Red/Yellow		140MT-C-KRY

Feeder Terminals and Compact Busbars

Description	For Use With	Cat. No.
Feeder Block for Compact Busbar • Supply of compact busbars • Increases terminal capacity	140MT-C, -D	140MT-C-WBE
Feeder Terminal for Compact Busbar • Meets UL Type E spacing requirements	140MT-C, -D 140M-F	140MT-C-WTEN 140M-F-WTE
Three-Phase Compact Busbar for 32 A Motor Protection Circuit Breakers - 64 A Max. Continuous Current • 45 mm spacing • Front-mounted auxiliary contact	2 connections	140MT-C, -D
	3 connections	140MT-C, -D
	4 connections	140MT-C, -D
	5 connections	140MT-C, -D
Three-Phase Compact Busbar for 32 A Motor Protection Circuit Breakers - 64 A Max. Continuous Current • 54 mm spacing • Side-mounted auxiliary contact	2 connections	140MT-C, -D
	3 connections	140MT-C, -D
	4 connections	140MT-C, -D
	5 connections	140MT-C, -D
Three-Phase Compact Busbar for 45 A Motor Protection Circuit Breakers - 115 A Max. Continuous Current • 54 mm spacing • Front-mounted auxiliary contact	2 connections	140M-F
	3 connections	140M-F
	4 connections	140M-F
	4 connections	140M-F
Three-Phase Compact Busbar for 45 A Motor Protection Circuit Breakers - 115 A Max. Continuous Current • 63 mm spacing • Side-mounted auxiliary contact	2 connections	140M-F
	3 connections	140M-F
	4 connections	140M-F

140MG Motor Circuit Protectors and 140MG Motor Protection Circuit Breakers

Operating Mechanisms

Description	For Use With	Shaft Length	Cat. No.
Rotary, variable depth operator kits	140MG-G, I Frames	12 in (30.48 mm)	140G-G-RVM12B
		21 in (53.34 mm)	140G-G-RVM21B
	140MG-H, J Frames	12 in (30.48 mm)	140G-H-RVM12B
		21 in (53.34 mm)	140G-H-RVM21B

Description	For Use With	Cable Length	Cat. No.
Flex cable operator kits	140MG-G Frame	3 ft (9.1 m)	140G-G-FCXB03
		4 ft (1.3 m)	140G-G-FCXB04
		6 ft (1.9 m)	140G-G-FCXB06
	140MG-H, Frame	3 ft (9.1 m)	140G-H-FCXB03
		4 ft (1.3 m)	140G-H-FCXB04
		6 ft (1.9 m)	140G-H-FCXB06

Voltage Trip Units

Description	Trip Rating	For Use With	Cat. No.
Shunt trip	110...127V AC/ 110...125V DC	140MG-H, J	140G-G-SND
			140G-G-SNA
	220...240V AC/ 220...250V DC		140G-G-SNJ
			24...30V AC/DC
Undervoltage trip	110...127V AC/ 110...125V DC	140MG-H, J	140G-G-UVD
			140G-G-UVA
	220...240V AC/ 220...250V DC		140G-G-UVJ
			24...30V AC/DC

Circuit Breakers



1-2...1-15

Disconnect Switches



1-16...1-23

Control & Load Switches



1-24...1-27

Contactors



1-28...1-41

Starters



1-42...1-55

Motor Protection



1-56...1-61

Smart Motor Control



1-62...1-71



Product Selection

140G Assembled Molded Case Circuit Breakers

G Frame, Thermal-Magnetic, Fixed



Rated Current I_n [A]	Thermal Trip [A] $I_r = I_n$	Magnetic Trip [A] I_m	Interrupting Code G2 ²		Interrupting Code G3 ²		Interrupting Code G6 ²	
			Cat. No.		Cat. No.		Cat. No.	
			3 Poles	4 Poles	3 Poles	4 Poles	3 Poles	4 Poles
15	15	500	140G-G2C3-C15	140G-G2C4-C15	140G-G3C3-C15	140G-G3C4-C15	140G-G6C3-C15	140G-G6C4-C15
16	16	500	140G-G2C3-C16	140G-G2C4-C16	140G-G3C3-C16	140G-G3C4-C16	140G-G6C3-C16	140G-G6C4-C16
20	20	500	140G-G2C3-C20	140G-G2C4-C20	140G-G3C3-C20	140G-G3C4-C20	140G-G6C3-C20	140G-G6C4-C20
25	25	500	140G-G2C3-C25	140G-G2C4-C25	140G-G3C3-C25	140G-G3C4-C25	140G-G6C3-C25	140G-G6C4-C25
30	30	500	140G-G2C3-C30	140G-G2C4-C30	140G-G3C3-C30	140G-G3C4-C30	140G-G6C3-C30	140G-G6C4-C30
32	32	500	140G-G2C3-C32	140G-G2C4-C32	140G-G3C3-C32	140G-G3C4-C32	140G-G6C3-C32	140G-G6C4-C32
35	35	500	140G-G2C3-C35	140G-G2C4-C35	140G-G3C3-C35	140G-G3C4-C35	140G-G6C3-C35	140G-G6C4-C35
40	40	500	140G-G2C3-C40	140G-G2C4-C40	140G-G3C3-C40	140G-G3C4-C40	140G-G6C3-C40	140G-G6C4-C40
45	45	500	140G-G2C3-C45	140G-G2C4-C45	140G-G3C3-C45	140G-G3C4-C45	140G-G6C3-C45	140G-G6C4-C45
50	50	500	140G-G2C3-C50	140G-G2C4-C50	140G-G3C3-C50	140G-G3C4-C50	140G-G6C3-C50	140G-G6C4-C50
60	60	600	140G-G2C3-C60	140G-G2C4-C60	140G-G3C3-C60	140G-G3C4-C60	140G-G6C3-C60	140G-G6C4-C60
63	63	600	140G-G2C3-C63	140G-G2C4-C63	140G-G3C3-C63	140G-G3C4-C63	140G-G6C3-C63	140G-G6C4-C63
70	70	700	140G-G2C3-C70	140G-G2C4-C70	140G-G3C3-C70	140G-G3C4-C70	140G-G6C3-C70	140G-G6C4-C70
80	80	800	140G-G2C3-C80	140G-G2C4-C80	140G-G3C3-C80	140G-G3C4-C80	140G-G6C3-C80	140G-G6C4-C80
90	90	900	140G-G2C3-C90	140G-G2C4-C90	140G-G3C3-C90	140G-G3C4-C90	140G-G6C3-C90	140G-G6C4-C90
100	100	1000	140G-G2C3-D10	140G-G2C4-D10	140G-G3C3-D10	140G-G3C4-D10	140G-G6C3-D10	140G-G6C4-D10
110	110	1100	140G-G2C3-D11	140G-G2C4-D11	140G-G3C3-D11	140G-G3C4-D11	140G-G6C3-D11	140G-G6C4-D11
125	125	1250	140G-G2C3-D12	140G-G2C4-D12	140G-G3C3-D12	140G-G3C4-D12	140G-G6C3-D12	140G-G6C4-D12
160 ³	112...160	1600	140G-G2E3-D16	140G-G2E4-D16	140G-G3E3-D16	140G-G3E4-D16	140G-G6E3-D16	140G-G6E4-D16

H Frame, Thermal-Magnetic, Fixed and Adjustable

Rated Current I_n [A]	Thermal Trip [A] $I_r = I_n$	Magnetic Trip [A] I_m	Interrupting Code H2 ²		Interrupting Code H3 ²		Interrupting Code H6 ²	
			Cat. No.		Cat. No.		Cat. No.	
			3 Poles	4 Poles	3 Poles	4 Poles	3 Poles	4 Poles
15	15	400	140G-H2C3-C15	140G-H2C4-C15	140G-H3C3-C15	140G-H3C4-C15	140G-H6C3-C15	140G-H6C4-C15
16	16	400	140G-H2C3-C16	140G-H2C4-C16	140G-H3C3-C16	140G-H3C4-C16	140G-H6C3-C16	140G-H6C4-C16
20	20	400	140G-H2C3-C20	140G-H2C4-C20	140G-H3C3-C20	140G-H3C4-C20	140G-H6C3-C20	140G-H6C4-C20
25	25	400	140G-H2C3-C25	140G-H2C4-C25	140G-H3C3-C25	140G-H3C4-C25	140G-H6C3-C25	140G-H6C4-C25
30	30	400	140G-H2C3-C30	140G-H2C4-C30	140G-H3C3-C30	140G-H3C4-C30	140G-H6C3-C30	140G-H6C4-C30
32	32	400	140G-H2C3-C32	140G-H2C4-C32	140G-H3C3-C32	140G-H3C4-C32	140G-H6C3-C32	140G-H6C4-C32
35	35	400	140G-H2C3-C35	140G-H2C4-C35	140G-H3C3-C35	140G-H3C4-C35	140G-H6C3-C35	140G-H6C4-C35
40	40	400	140G-H2C3-C40	140G-H2C4-C40	140G-H3C3-C40	140G-H3C4-C40	140G-H6C3-C40	140G-H6C4-C40
45	45	500	140G-H2C3-C45	140G-H2C4-C45	140G-H3C3-C45	140G-H3C4-C45	140G-H6C3-C45	140G-H6C4-C45
50	50	500	140G-H2C3-C50	140G-H2C4-C50	140G-H3C3-C50	140G-H3C4-C50	140G-H6C3-C50	140G-H6C4-C50
60	60	600	140G-H2C3-C60	140G-H2C4-C60	140G-H3C3-C60	140G-H3C4-C60	140G-H6C3-C60	140G-H6C4-C60
63	63	600	140G-H2C3-C63	140G-H2C4-C63	140G-H3C3-C63	140G-H3C4-C63	140G-H6C3-C63	140G-H6C4-C63
70	70	700	140G-H2C3-C70	140G-H2C4-C70	140G-H3C3-C70	140G-H3C4-C70	140G-H6C3-C70	140G-H6C4-C70
80	56...80	400...800	140G-H2F3-C80	140G-H2F4-C80	140G-H3F3-C80	140G-H3F4-C80	140G-H6F3-C80	140G-H6F4-C80
90	63...90	450...900	140G-H2F3-C90	140G-H2F4-C90	140G-H3F3-C90	140G-H3F4-C90	140G-H6F3-C90	140G-H6F4-C90
100	70...100	500...1000	140G-H2F3-D10	140G-H2F4-D10	140G-H3F3-D10	140G-H3F4-D10	140G-H6F3-D10	140G-H6F4-D10
110	77...110	550...1100	140G-H2F3-D11	140G-H2F4-D11	140G-H3F3-D11	140G-H3F4-D11	140G-H6F3-D11	140G-H6F4-D11
125	87...125	625...1250	140G-H2F3-D12	140G-H2F4-D12	140G-H3F3-D12	140G-H3F4-D12	140G-H6F3-D12	140G-H6F4-D12
160 ³	112...160	800...1600	140G-H2F3-D16	140G-H2F4-D16	140G-H3F3-D16	140G-H3F4-D16	140G-H6F3-D16	140G-H6F4-D16

² See page 1-12 for the interrupting rating/breaking capacity specifications.

³ IEC only.

Note: End Cap terminals provided as standard.

Drives



For more information on our complete family of circuit protection products, please visit:
<https://rok.auto/circuit-load-protection>



Circuit Breakers

Product Selection

140G Assembled Molded Case Circuit Breakers I Frame, Thermal-Magnetic, Fixed

Rated Current I_n [A]	Thermal Trip [A] $I_r = I_n$	Magnetic Trip [A] I_m	Interrupting Code I2 ²		Interrupting Code I3 ²	
			Cat. No.		Cat. No.	
			3 Poles	4 Poles	3 Poles	4 Poles
90	90	900	140G-I2C3-C90	140G-I2C4-C90	140G-I3C3-C90	140G-I3C4-C90
100	100	1000	140G-I2C3-D10	140G-I2C4-D10	140G-I3C3-D10	140G-I3C4-D10
125	125	1250	140G-I2C3-D12	140G-I2C4-D12	140G-I3C3-D12	140G-I3C4-D12
150	150	1500	140G-I2C3-D15	140G-I2C4-D15	140G-I3C3-D15	140G-I3C4-D15
175	175	1750	140G-I2C3-D17	140G-I2C4-D17	140G-I3C3-D17	140G-I3C4-D17
200	200	2000	140G-I2C3-D20	140G-I2C4-D20	140G-I3C3-D20	140G-I3C4-D20
225	225	2250	140G-I2C3-D22	140G-I2C4-D22	140G-I3C3-D22	140G-I3C4-D22

J Frame, Thermal-Magnetic, Adjustable

Rated Current I_n [A]	Thermal Trip [A] $I_r = I_n$	Magnetic Trip [A] I_m	Interrupting Code J2 ²		Interrupting Code J3 ²		Interrupting Code J6 ²	
			Cat. No.		Cat. No.		Cat. No.	
			3 Poles	4 Poles	3 Poles	4 Poles	3 Poles	4 Poles
80	56...80	400...800	140G-J2F3-C80	140G-J2F4-C80	140G-J3F3-C80	140G-J3F4-C80	140G-J6F3-C80	140G-J6F4-C80
90	63...90	450...900	140G-J2F3-C90	140G-J2F4-C90	140G-J3F3-C90	140G-J3F4-C90	140G-J6F3-C90	140G-J6F4-C90
100	70...100	500...1000	140G-J2F3-D10	140G-J2F4-D10	140G-J3F3-D10	140G-J3F4-D10	140G-J6F3-D10	140G-J6F4-D10
110	77...110	550...1100	140G-J2F3-D11	140G-J2F4-D11	140G-J3F3-D11	140G-J3F4-D11	140G-J6F3-D11	140G-J6F4-D11
125	87...125	625...1250	140G-J2F3-D12	140G-J2F4-D12	140G-J3F3-D12	140G-J3F4-D12	140G-J6F3-D12	140G-J6F4-D12
150	105...160	750...1500	140G-J2F3-D15	140G-J2F4-D15	140G-J3F3-D15	140G-J3F4-D15	140G-J6F3-D15	140G-J6F4-D15
160	112...150	800...1600	140G-J2F3-D16	140G-J2F4-D16	140G-J3F3-D16	140G-J3F4-D16	140G-J6F3-D16	140G-J6F4-D16
175	122.5...175	875...1750	140G-J2F3-D17	140G-J2F4-D17	140G-J3F3-D17	140G-J3F4-D17	140G-J6F3-D17	140G-J6F4-D17
200	140...200	1000...2000	140G-J2F3-D20	140G-J2F4-D20	140G-J3F3-D20	140G-J3F4-D20	140G-J6F3-D20	140G-J6F4-D20
225	157.5...225	1125...2250	140G-J2F3-D22	140G-J2F4-D22	140G-J3F3-D22	140G-J3F4-D22	140G-J6F3-D22	140G-J6F4-D22
250	175...250	1250...2500	140G-J2F3-D25	140G-J2F4-D25	140G-J3F3-D25	140G-J3F4-D25	140G-J6F3-D25	140G-J6F4-D25

K Frame, Thermal-Magnetic, Adjustable

Rated Current I_n [A]	Thermal Trip [A] $I_r = I_n$	Magnetic Trip [A] I_m	Interrupting Code K3 ²		Interrupting Code K6 ²		Interrupting Code K0 ²	
			Cat. No.		Cat. No.		Cat. No.	
			3 Poles	4 Poles	3 Poles	4 Poles	3 Poles	4 Poles
300	210...300	1500...3000	140G-K3F3-D30	140G-K3F4-D30	140G-K6F3-D30	140G-K6F4-D30	140G-K0F3-D30	140G-K0F4-D30
400	280...400	2000...4000	140G-K3F3-D40	140G-K3F4-D40	140G-K6F3-D40	140G-K6F4-D40	140G-K0F3-D40	140G-K0F4-D40

M Frame, Thermal-Magnetic, Adjustable

Rated Current I_n [A]	Thermal Trip [A] $I_r = I_n$	Magnetic Trip [A] I_m	Interrupting Code M5 ²		Interrupting Code M6 ²		Interrupting Code M0 ²	
			Cat. No.		Cat. No.		Cat. No.	
			3 Poles	4 Poles	3 Poles	4 Poles	3 Poles	4 Poles
600	420...600	3000...6000	140G-M5F3-D60	140G-M5F4-D60	140G-M6F3-D60	140G-M6F4-D60	140G-M0F3-D60	140G-M0F4-D60
630 ³	441...630	3150...6300	140G-M5F3-D63	140G-M5F4-D63	140G-M6F3-D63	140G-M6F4-D63	140G-M0F3-D63	140G-M0F4-D63
800	560...800	4000...8000	140G-M5F3-D80	140G-M5F4-D80	140G-M6F3-D80	140G-M6F4-D80	140G-M0F3-D80	140G-M0F4-D80

² See page 1-12 for the interrupting rating/breaking capacity specifications.

³ IEC only.

Note: End Cap terminals provided as standard.

Circuit Breakers



1-2...1-15

Disconnect Switches



1-16...1-23

Control & Load Switches



1-24...1-27

Contactors



1-28...1-41

Starters



1-42...1-55

Motor Protection



1-56...1-61

Smart Motor Control



1-62...1-71



Product Selection

140G Assembled Current-limiting Molded Case Circuit Breakers H Frame, Thermal-Magnetic, Fixed and Adjustable

Rated Current I_n [A]	Thermal Trip [A] I_T	Magnetic Trip [A] I_m	Interrupting Code HC6	Interrupting Code HCO
			Cat. No.	Cat. No.
15	15	400	140G-HC6C3-C15	140G-HCOC3-C15
20	20	400	140G-HC6C3-C20	140G-HCOC3-C20
30	30	400	140G-HC6C3-C30	140G-HCOC3-C30
40	40	400	140G-HC6C3-C40	140G-HCOC3-C40
50	50	500	140G-HC6C3-C50	140G-HCOC3-C50
60	60	600	140G-HC6C3-C60	140G-HCOC3-C60
70	70	700	140G-HC6C3-C70	140G-HCOC3-C70
80	56...80	400...800	140G-HC6F3-C80	140G-HCOF3-C80
90	63...90	450...900	140G-HC6F3-C90	140G-HCOF3-C90
100	70...100	500...1000	140G-HC6F3-D10	140G-HCOF3-D10
125	87...125	625...1250	140G-HC6F3-D12	140G-HCOF3-D12
160 ³	112...160	800...1600	140G-HC6F3-D16	140G-HCOF3-D16

³ IEC only.

J Frame, Thermal-Magnetic, Fixed and Adjustable

Rated Current I_n [A]	Thermal Trip [A] I_T	Magnetic Trip [A] I_m	Interrupting Code JC6	Interrupting Code JCO
			Cat. No.	Cat. No.
25	25	400	140G-JC6C3-C25	140G-JCOC3-C25
30	30	400	140G-JC6C3-C30	140G-JCOC3-C30
40	40	400	140G-JC6C3-C40	140G-JCOC3-C40
50	50	500	140G-JC6C3-C50	140G-JCOC3-C50
60	60	600	140G-JC6C3-C60	140G-JCOC3-C60
70	70	700	140G-JC6C3-C70	140G-JCOC3-C70
80	56...80	400...800	140G-JC6F3-C80	140G-JCOF3-C80
90	63...90	450...900	140G-JC6F3-C90	140G-JCOF3-C90
100	70...100	500...1000	140G-JC6F3-D10	140G-JCOF3-D10
125	87.5...125	625...1250	140G-JC6F3-D12	140G-JCOF3-D12
150	105...150	750...1500	140G-JC6F3-D15	140G-JCOF3-D15
160	112...160	800...1600	140G-JC6F3-D16	140G-JCOF3-D16
175	122.5...175	875...1750	140G-JC6F3-D17	140G-JCOF3-D17
200	140...200	1000...2000	140G-JC6F3-D20	140G-JCOF3-D20
225	157.5...225	1125...2250	140G-JC6F3-D22	140G-JCOF3-D22
250	175...250	1250...2500	140G-JC6F3-D25	140G-JCOF3-D25

K Frame, Thermal-Magnetic, Fixed and Adjustable

Rated Current I_n [A]	Thermal Trip [A] I_T	Magnetic Trip [A] I_m	Interrupting Code HC6	Interrupting Code HCO
			Cat. No.	Cat. No.
15	15	400	140G-HC6C3-C15	140G-HCOC3-C15
20	20	400	140G-HC6C3-C20	140G-HCOC3-C20

Current-limiting molded case circuit breakers (MCCBs) are rated to open in less than half of a cycle under fault conditions which limits the let-through energy, providing enhanced protection for downstream components.

Drives



1-72...1-77

For more information on our complete family of circuit protection products, please visit:
<https://rok.auto/circuit-load-protection>



Circuit Breakers

Product Selection

Interrupting Rating/Breaking Capacity – Thermal-Magnetic Circuit Breakers

Interrupting Rating (50/60 Hz), UL 489/CSA C22.2-5, No. 5-02 [kA]			Breaking Capacity (50/60 Hz), IEC 60947-2 I_{cu} [kA] / I_{cs} %								Interrupting Code	Frame
240V	480V	600V/ 347V	220V		415V		440V		690V			
			I_{cu} [kA]	I_{cs} [%] I_{cu}	I_{cu} [kA]	I_{cs} [%] I_{cu}	I_{cu} [kA]	I_{cs} [%] I_{cu}	I_{cu} [kA]	I_{cs} [%] I_{cu}		
50	25	10	65	75	36	100	36	50	6	75	G2	G
65	35	14	85	75	50	100	50	50	8	50	G3	
100	65	25	100	75	70	50	65	50	10	50	G6	
240V	480V	600V	220V		415V		440V		690V		Interrupting Code	Frame
			I_{cu} [kA]	I_{cs} [%] I_{cu}	I_{cu} [kA]	I_{cs} [%] I_{cu}	I_{cu} [kA]	I_{cs} [%] I_{cu}	I_{cu} [kA]	I_{cs} [%] I_{cu}		
65	25	14	65	100	36	100	36	100	10	100	H2	H
100	35	18	85	100	50	100	50	100	12	100	H3	
150	65	25	100	100	70	100	65	100	15	100	H6, HC6	
200	100	35	150	100	120	100	100	100	18	100	H0, HCO	
200	150	42	200	100	150	100	150	100	20	75	H15	
240V	480V	600V/ 347V	220V		415V		440V		690V		Interrupting Code	Frame
			I_{cu} [kA]	I_{cs} [%] I_{cu}	I_{cu} [kA]	I_{cs} [%] I_{cu}	I_{cu} [kA]	I_{cs} [%] I_{cu}	I_{cu} [kA]	I_{cs} [%] I_{cu}		
50	25	10	50	75	36	75	25	75	5	50	I2	I
65	35	10	85	50	50	50	40	50	6	50	I3	
240V	480V	600V	220V		415V		440V		690V		Interrupting Code	Frame
			I_{cu} [kA]	I_{cs} [%] I_{cu}	I_{cu} [kA]	I_{cs} [%] I_{cu}	I_{cu} [kA]	I_{cs} [%] I_{cu}	I_{cu} [kA]	I_{cs} [%] I_{cu}		
100	35	18	85	100	50	100	50	100	12	100	J3	J
150	65	25	100	100	70	100	65	100	15	100	J6	
200	100	35	150	100	120	100	100	100	20	100	J0	
240V	480V	600V	220V		415V		440V		690V		Interrupting Code	Frame
			I_{cu} [kA]	I_{cs} [%] I_{cu}	I_{cu} [kA]	I_{cs} [%] I_{cu}	I_{cu} [kA]	I_{cs} [%] I_{cu}	I_{cu} [kA]	I_{cs} [%] I_{cu}		
100	35	25	85	100	50	100	40	100	25	100	K3	K
150	65	35	100	100	70	100	65	100	40	100	K6	
200	100	65	200	100	120	100	100	100	70	100	K0	
240V	480V	600V	220V		415V		690V		Interrupting Code	Frame		
			I_{cu} [kA]	I_{cs} [%] I_{cu}	I_{cu} [kA]	I_{cs} [%] I_{cu}	I_{cu} [kA]	I_{cs} [%] I_{cu}				
100	50	25	85	100	50	100	22	75	M5	M		
200	65	35	100	100	70	100	25	75	M6			
200	100	42	200	100	100	100	30	75	M0			

Circuit Breakers



1-2...1-15

Disconnect Switches



1-16...1-23

Control & Load Switches



1-24...1-27

Contactors



1-28...1-41

Starters



1-42...1-55

Motor Protection



1-56...1-61

Smart Motor Control



1-62...1-71

Accessories

140G Assembled Molded Case Circuit Breakers Terminal Lugs

Description	Frame Size	Cat. No. (Pkg. Qty. 3)	Cat. No. (Pkg. Qty. 4)
Cu wire, MCCB only (1) 14...1/0 AWG or 2.5...70 mm ²	G	140G-G-TLC13	140G-G-TLC14
Cu wire, MCP only (1) 14...1/0 AWG or 1.5...70 mm ²		140G-G-TLC13A	-
Multiple cable - Cu wire (6) 14...2 AWG or 2.5...35 mm ²		140G-G-MTL63	140G-G-MTL64
Cu wire only (1) 14...1/0 AWG or 2.5...95 mm ²	H	140G-G-TLC13	140G-G-TLC14
Multiple cable - Cu wire (6) 14...2 AWG or 2.5...35 mm ²		140G-G-MTL63	140G-G-MTL64
Al or Cu wire (1) 14...1/0 AWG or 2.5...50 mm ²	I	140G-I-TLA13	140G-I-TLA14
Al or Cu wire (1) 4...300 MCM or 25...150 mm ²		140G-I-TLA1A3	140G-I-TLA1A4
Cu wire only (1) 10...250 MCM or 6...185 mm ²		140G-I-TLC13	140G-I-TLC14
Multiple cable - Cu wire (6) 12...2 AWG or 2.5...35 mm ²		140G-I-MTL63	140G-I-MTL64
Al or Cu wire (1) 14...1/0 AWG or 2.5...50 mm ²	J	140G-J-TLA13	140G-J-TLA14
Al or Cu wire (1) 4...300 MCM or 25...150 mm ²		140G-J-TLA1A3	140G-J-TLA1A4
Cu wire only (1) 10...250 MCM or 6...185 mm ²		140G-J-TLC13	140G-J-TLC14
Multiple cable - Cu wire (6) 12...2 AWG or 2.5...35 mm ²		140G-J-MTL63	140G-J-MTL64
Cu wire only (1) 250...350 MCM or 120...185 mm ²		140G-J-TLC1A3	140G-J-TLC1A4
Al or Cu wire (1) 250...500 MCM or 120...240 mm ²	K	140G-K-TLA13	140G-K-TLA14
Al or Cu wire (2) 2/0...250 MCM or 95...120 mm ²		140G-K-TLA23	140G-K-TLA24
Multiple cable - Cu wire (6) 6...1/0 AWG or 16...50 mm ²		140G-K-MTL63	140G-K-MTL64
Al or Cu wire (2) 250...500 MCM or 120...240 mm ²	M	140G-M-TLA23	140G-M-TLA24
Al or Cu wire (3) 2/0...400 MCM or 7...185 mm ²		140G-M-TLA13	140G-M-TLA14

Frame Size	Height	3-Pole Cat. No. (Pkg. Qty. 2)	4-Pole Cat. No. (Pkg. Qty. 2)
G	2 in. (50 mm)	140G-G-TC3H	140G-G-TC4H
H	2 in. (50 mm)	140G-H-TC3H	140G-H-TC4H
I	2.36 in. (60 mm)	140G-I-TC3H	140G-I-TC4H
J	2.36 in. (60 mm)	140G-J-TC3H	140G-J-TC4H
K	2.36 in. (60 mm)	140G-K-TC3H	140G-K-TC4H
M	2.36 in. (60 mm)	140G-M-TC3H	140G-M-TC4H



Global Short Circuit Current Ratings Selection Tool

Try out the Global SCCR Selection Tool, providing coordinated high fault branch circuit solutions for motor starters, soft starters and component drives.

<https://rok.auto/sccr>

Drives



1-72...1-77

For more information on our complete family of circuit protection products, please visit:
<https://rok.auto/circuit-load-protection>



Circuit Breakers

Accessories

140G Assembled Molded Case Circuit Breakers Operating Mechanisms

POWER

Description	Frame Size	Handle Color	Shaft Length	Cat. No.
Rotary, variable depth operator kits	G, I	Black	12 in (305 mm)	140G-G-RVM12B
		Red/Yellow		140G-G-RVM12R
		Black	21 in (533 mm)	140G-G-RVM21B
		Red/Yellow		140G-G-RVM21R
	H, J	Black	12 in (305 mm)	140G-H-RVM12B
		Red/Yellow		140G-H-RVM12R
		Black	21 in (533 mm)	140G-H-RVM21B
		Red/Yellow		140G-H-RVM21R
	K	Black	12 in (305 mm)	140G-K-RVM12B
		Red/Yellow		140G-K-RVM12R
		Black	22 in (559 mm)	140G-K-RVM21B
		Red/Yellow		140G-K-RVM21R
	M	Black	12 in (305 mm)	140G-M-RVM12B
		Red/Yellow		140G-M-RVM12R
		Black	22 in (559 mm)	140G-M-RVM21B
		Red/Yellow		140G-M-RVM21R

Description	Frame Size	Handle Type	Cable Length	Cat. No.
Flex cable operator kits	G	Non-metallic Handle, Type 1/3/12/4/4X	3 ft (.91 m)	140G-G-FCXB03
			4 ft (1.3 m)	140G-G-FCXB04
			6 ft (1.9 m)	140G-G-FCXB06
			10 ft (3.0 m)	140G-G-FCXB10
		Stainless Steel Handle, Type 4/4X	3 ft (.91 m)	140G-G-FCSB03
			4 ft (1.3 m)	140G-G-FCSB04
			6 ft (1.9 m)	140G-G-FCSB06
			10 ft (3.0 m)	140G-G-FCSB10
	H	Non-metallic Handle, Type 1/3/12/4/4X	3 ft (.91 m)	140G-H-FCXB03
			4 ft (1.3 m)	140G-H-FCXB04
			6 ft (1.9 m)	140G-H-FCXB06
			10 ft (3.0 m)	140G-H-FCXB10
		Stainless Steel Handle, Type 4/4X	3 ft (.91 m)	140G-H-FCSB03
			4 ft (1.3 m)	140G-H-FCSB04
			6 ft (1.9 m)	140G-H-FCSB06
			10 ft (3.0 m)	140G-H-FCSB10
I	Non-metallic Handle, Type 1/3/12/4/4X	3 ft (.91 m)	140G-I-FMXB03	
		6 ft (1.9 m)	140G-I-FMXB06	

Circuit Breakers



1-2...1-15

Disconnect Switches



1-16...1-23

Control & Load Switches



1-24...1-27

Contactors



1-28...1-41

Starters



1-42...1-55

Motor Protection



1-56...1-61

Smart Motor Control



1-62...1-71

Accessories

140G Assembled Molded Case Circuit Breakers Operating Mechanisms

Description	Frame Size	Handle Type	Cable Length	Cat. No.
Flex cable operator kits	J	Non-metallic Handle, Type 1/3/12/4/4X	3 ft (.91 m)	140G-J-FCXB03
			4 ft (1.3 m)	140G-J-FCXB04
			6 ft (1.9 m)	140G-J-FCXB06
			10 ft (3.0 m)	140G-J-FCXB10
		Stainless Steel Handle, Type 4/4X	3 ft (.91 m)	140G-J-FCSB03
			4 ft (1.3 m)	140G-J-FCSB04
			6 ft (1.9 m)	140G-J-FCSB06
			10 ft (3.0 m)	140G-J-FCSB10
	K	Non-metallic Handle, Type 1/3/12/4/4X	3 ft (.91 m)	140G-K-FCXB03
			4 ft (1.3 m)	140G-K-FCXB04
			6 ft (1.9 m)	140G-K-FCXB06
			10 ft (3.0 m)	140G-K-FCXB10
		Stainless Steel Handle, Type 4/4X	3 ft (.91 m)	140G-K-FCSB03
			4 ft (1.3 m)	140G-K-FCSB04
			6 ft (1.9 m)	140G-K-FCSB06
			10 ft (3.0 m)	140G-K-FCSB10

Auxiliary Contacts

Description	Designation	For Use With	Cat. No.
(1) Auxiliary contact, 250V	AX2	140G-G, H, I, J	140G-G-EA1A
(1) Auxiliary, (1) alarm contact, 250V	AX2/AL1		140G-G-EA1RIA
(1) Auxiliary contact, 24V	1		140G-G-EA1J
(1) Auxiliary, (1) alarm contact, 24V	2		140G-G-EA1RJ
(1) Auxiliary, (1) alarm contact, 250V	AX2/AL1	K, M	140G-K-EA1RIA
(1) Auxiliary, (1) alarm contact, 24V			140G-K-EA1RJ

Shunt Trips

Description	Frame Size	Cat. No.
24...30V AC/DC	G, H, I, J	140G-G-SNJ
48...60V AC/DC		140G-G-SNKY
110...127V AC/110...125V DC		140G-G-SND
220...240V AC/220...250V DC		140G-G-SNA
24...30V AC/DC	K, M	140G-G-SNJ
48...60V AC/DC		140G-G-SNKY
110...127V AC/110...125V DC		140G-G-SND
220...240V AC/220...250V DC		140G-G-SNA

Undervoltage Release

Description	Frame Size	Cat. No.
24...30V AC/DC	G, H, I, J	140G-G-UVJ
48V AC/DC		140G-G-UVKY
60V AC/DC		140G-G-UVY
110...127V AC/110...125V DC		140G-G-UVD
220...240V AC/220...250V DC		140G-G-UVA
380...440V AC		140G-G-UVB
480...525V AC		140G-G-UVC
24...30V AC/DC		K, M
48V AC/DC	140G-K-UKY	
60V AC/DC	140G-K-UVY	
110...127V AC/110...125V DC	140G-K-UVD	
220...240V AC/220...250V DC	140G-K-UVA	
380...440V AC	140G-K-UVB	



Product Selection Tools

Available online or for download, our tools help you access info while in the office or on the go.

<https://rok.auto/selection>

Drives



1-72...1-77

For more information on our complete family of circuit protection products, please visit:
<https://rok.auto/circuit-load-protection>



Disconnect Switches



Rotary Disconnect Switch, Fused 194R

- Up to 1250 A for IEC, and 800 A for UL
- Touch-safe, compact design
- Padlocking available
- Double-break switching for full fuse line and load side isolation when switch is OFF
- Side operation

Rotary Disconnect Switch, Non-fused 194R

- Up to 1250 A for IEC, and 1200 A for UL
- Compact footprint for both UL and IEC switch bodies
- Suitable for severe utilization categories (AC-22 & AC-23)



Rotary Disconnect Switch, Enclosed 194R

- Lock-out tag-out functionality
- Use as at-motor isolation
- Enclosure options:
 - Stainless Steel, NEMA 4/4X (194R-C)
 - Painted Metal, NEMA 3/4/12 (194R-F)
 - Thermoplastic, NEMA 4/4X (194R-K)

* For enclosed disconnect switches, please visit <https://rok.auto/directory>.



Product Selection

194R Rotary Disconnect Switches, UL/CSA

Rated Current [A]	Maximum Hp Ratings, 3-Phase (60 Hz)				Fused		Non-Fused
	240V	480V	600V		Fuse Type	Cat. No. ¹	Cat. No. ³
			Fused	Non-Fused			
30	7.5	15	20	20	30 A Class J, HRCI-J	194R-J30-1753 ²	194R-N30-1753
60	15	30	50	40	60 A Class J, HRCI-J	194R-J60-1753 ²	194R-N60-1753
100	30	60	75	100	100 A Class J, HRCI-J	194R-J100-1753	194R-NU100-1753
200	60	125	150	200	200 A Class J, HRCI-J	194R-J200-1753	194R-NU200-1753
400	125	250	350	350	400 A Class J, HRCI-J	194R-J400-1753	194R-NU400-1753
600	200	500	500	350	600 A Class J, HRCI-J	194R-J600-1753	194R-NU600-1753
800	200	500	500	500	800 A Class L, HRCI-L	194R-L800-1753	194R-NU800-1753
1200	200	500	-	500	-	-	194R-NU1200-1753

¹ Time delay fuses may be required to utilize the disconnect switch at its maximum horsepower rating.

² Blown fuse indicator available by adding **S** to the end of the catalog number.

³ Non-fused disconnect switches must use separately installed fuses for upstream short circuit protection.

194R Rotary Disconnect Switches, IEC

Load Rating [A]	Maximum kW Ratings				Fused		Non-Fused
	200/220/230V	380/400/415V	660/690V		Fuse Type	Cat. No.	Cat. No. ³
			Fused	Non-Fused			
32	9	18.5	30	-	NH000	194R-D32-1753	-
63	18.5	30	55	-	NH000	194R-D63-1753	-
125	-	63	90	55	NH00	194R-D125-1753	194R-NE125-1753
160	-	80	110	55	NH00	194R-D160-1753	194R-NE160-1753
250	-	132	220	90	NH1	194R-D250-1753	194R-NE250-1753
400	-	220	220	150	NH2	194R-D400-1753	194R-NE400-1753
630	-	355	295	150	NH3	194R-D630-1753	194R-NE630-1753
800	-	450	400	185	NH3	194R-D800-1753	194R-NE800-1753
1250	-	560	400	415	NH4a	194R-D1250-1753	194R-NE1250-1753

³ Non-fused disconnect switches must use separately installed fuses for upstream short circuit protection.



Padlockable handle, test mode (30...60 A)



Padlockable handle (100...400 A)



Padlockable handle, standard (30...60 A)

Operating Handles

Range	Handle Operating Shaft ⁴		Padlockable Handle	
	Cat. No. 12 in (304.8 mm)	Cat. No. 21 in (533.4 mm)	Cat. No. Black	Cat. No. Red/Yellow
up to 60 A	194R-S1	194R-S2	194R-PB	194R-PY
up to 60 A	194R-S1	194R-S2	194R-PBT	194R-PYT
100...400 A	194R-R7	194R-R8	194R-HM4	194R-HM4E
600...1250 A	194R-R9	194R-R10	194R-HM4-L	194R-HM4E-L

⁴ For additional lengths, please visit <https://rok.auto/directory>.

Drives



1-72...1-77

For more information on our complete family of circuit protection products, please visit: <https://rok.auto/circuit-load-protection>



Disconnect Switches

POWER

Rotary Disconnect Switch, Non-fused 194U

- Touch-safe, compact design
- UL 30...125 A - IEC 40...160 A
- Can be used as main panel disconnect switch (UL98), or as at-motor disconnect switch (UR)
- NFPA79 compliant handle for robust lock-out/tag-out
- Multiple configuration options



Configuration and Accessories

Body Styles

3- and 4-pole versions are available in both front and base mount.



Base mount style

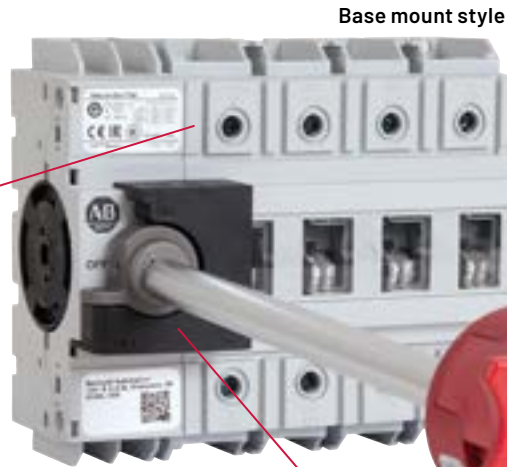

Base mount style

Lock out/tag out

Handle Options

Multiple handle options are available including the NFPA79-compliant handle for robust lock-out/tag-out.



194E handles 194R handles



194L handles

NFPA79-compliant handle

Accessories

Additional accessories are available to meet your application needs.



Ground and 4th pole terminals



Terminal shrouds



Auxiliary contacts

Disconnect Switches

Circuit Breakers



1-2...1-15



1-16...1-23

Control & Load Switches



1-24...1-27

Contactors



1-28...1-41

Starters



1-42...1-55

Motor Protection



1-56...1-61

Smart Motor Control



1-62...1-71

Product Selection

194U Rotary Disconnect Switches

Base Mount	3 pole	194U-A30-1753	194U-A60-1753	194U-A100-1753	194U-A160-1753	
	4 pole	194U-A30-1753 + 194U-A100-FP	194U-A60-1753 + 194U-A100-FP	194U-A100-1753 + 194U-A100-FP	194U-A160-1754	
Front Mount	3 pole	194U-E30-1753	194U-E60-1753	194U-E100-1753	194U-E160-1753	
	4 pole	194U-E30-1753 + 194U-E100-FP	194U-E60-1753 + 194U-E100-FP	194U-E100-1753 + 194U-E100-FP	194U-E160-1754	
Standard Compliance		cULus, EAC, IEC	cULus, EAC, IEC	cULus, EAC, IEC, CCC	cULus, EAC, IEC, CCC	
UL compliance		UL98	UL98	UL98	UL98	UR
Ampere Rating	[A]	30	60	100	100	125
Max Hp/FLA, 3-phase AC						
240V	[Hp/A]	10/28	20/54	30/80	40/104	40/104
480V	[Hp/A]	20/27	40/52	50/65	75/96	75/96
600V	[Hp/A]	30/32	30/32	30/32	100/99	100/99
Short Circuit Rating						
J Fuse	[kA]	200	200	200	100	100
T Fuse	[kA]	200	200	200	100	100
Fuse Size	[A]	100/60	100/60	100/100	200	200
Rated Oper. Current AC-23 A 400...415V	[A]	40	63	90	160	
Rated Oper. Power AC-23 A 400...415V	[kW]	15	18.5	45	75	

Handles and Accessories

Description	For Use with	Color / Type	Catalog Number
Padlockable Handle 3R, 3 1/2, 4, 4X Protection	Bul. 194U disconnect switches up to 60A	Black	194R-PB
		Red/Yellow	194R-PY
	Bul 194U base mounted switches, 30...125A	Black	194E-SB
		Red/Yellow	194E-SY
Type N handle, 0-I, OFF-ON 67x67mm	Front and base mount switches 30...100A	Red/Yellow	194L-HE6N-175
Switch handle	Front mounted switches up to 160A	Black	194U-FB
		Red/Yellow	194U-FY
NFPA 79 internal operating handle with 12in. (30,5cm) shaft	Bul 194U base mounted switches, 30...125A	-	194U-N1
Extension kit for N handle	Base mounted 30...100A	9.25in. (23,5cm)	194U-G3393
Shaft for S-Type handle	Base mounted 30...125A	12in. (30,5cm)	194U-S1
Front mount handle adapter	Front mounted switches	-	194U-DMA
Auxiliary Contact	All 194U switches	NC	194U-NC
		Auxiliary Contact	194U-NO
		NO/NC	194U-NONC
Terminal shroud	30...100A switches	1 pole (Qty 1)	194U-C1
		3 pole (Qty 1)	194U-C3
	125 (160)A switches	1 pole (Qty 1)	194U-160-C1
		3 pole (Qty 1)	194U-160-C3

Drives



1-72...1-77

For more information on our complete family of circuit protection products, please visit:
<https://rok.auto/circuit-load-protection>



Disconnect Switches

Visible Blade Disconnect Switch 1494U Universal Mechanism

- 30...100 A, 3-pole, 600 V AC/DC ratings
- Universal mechanism allows for rod or cable operation
- Fusible or non-fusible versions
- Lockable handle
- Visible blade construction for safety



Visible Blade Construction

- Reliable visible blade indication
- Blades visible – switch is de-energized
- Blades hidden – switch is energized

Fuse Blocks

- Common base across 30/60/100 A
 - Integrated Phase Barriers
 - J and R fuse clips are available for the fusible styles

Lug Connectors

- Included aluminum lugs will accept copper or aluminum wire

Universal Mechanism

- Provides flexibility of installation for either rod or cable operated applications



1494U Rod Operated System



1494U Cable Operated System

Lug Connectors

Disconnect Switch Size [A]	Description	Wire Size	Cat. No.
30...60	Aluminum, 1 port	(1) #14...2 AWG, copper-aluminum (2) #14...10 AWG, copper (2) #12...10 AWG, aluminum	1494U-LA36
100	Aluminum, 1 port	(2) #12...4 AWG, copper-aluminum (1) #14...1/0 AWG, copper (1) #12...1/0 AWG, aluminum	1494U-LA100
30...100	Aluminum, 6 port	(1) #14...4 AWG, copper (1) #12...4 AWG, aluminum (2) #10 AWG, copper-aluminum	1494U-LM31

Circuit Breakers



1-2...1-15

Disconnect Switches



1-16...1-23

Control & Load Switches



1-24...1-27

Contactors



1-28...1-41

Starters



1-42...1-55

Motor Protection



1-56...1-61

Smart Motor Control



1-62...1-71

Product Selection

1494U Disconnect Switches ¹

Continuous Current Rating [A] 600V AC, 600V DC	Maximum Hp - UL and CSA Applications					1-Phase, AC		DC ²	Maximum kW - IEC Applications (Category AC 23)			Switch with Right-Hand Mechanism Cat. No.
	3-Phase, 60 Hz					3-Phase, 50 Hz			3-Phase, 50 Hz			
	115V	200...208V	230V	460V	575V	115V	230V		600V	220...240V	380...440V	
30	3	7.5	7.5	15	20	2	3	15	5.5	11	15	1494U-D30
60	7.5	15	15	30	50	3	10	30	11	22	37	1494U-D60
100	-	25	30	60	75	-	-	50	22	45	55	1494U-D100

¹ Aluminum lug/line kits are provided with each disconnect switch.

² Ratings based on using two poles in series to break one line of the DC supply voltage and the remaining pole breaking the second DC supply line.

Connecting Rods

Disconnect Switch Size [A]	Enclosure Working Depth [in. (mm)] ³		Cat. No.
	Minimum	Maximum	
30, 60, 100, 200	6-3/4 (172)	19 (483)	1494U-R1

³ Enclosure working depth is measured from the top of the flange to the disconnect switch mounting surface. Dimensions are approximate.
NOTE: For enclosure depths greater than 19 in. but less than 23 in., select catalog number 1494V-RA4.

Operating Handles

Handle Type	Description	Mounting	Disconnect Switch Size [A]	Cat. No.
Type 1, 3R, 4, 4X, 12	Nonmetallic	Right or Left Flange	30, 60, 100	1494U-HP1
Type 1, 3R, 4, 12	Painted Metal			1494U-HM1
Type 4, 4X	Stainless Steel			1494U-HS1

Cable Mechanism

Disconnect Switch Size [A]	Cable Length [ft (m)]	Right-Hand Cable Mechanism Cat. No.
30, 60, 100	3 (0.91)	1494U-C313
	4 (1.22)	1494U-C314
	5 (1.52)	1494U-C315
	6 (1.83)	1494U-C316

Fuse Clip Kits

Fuse Class	Fuse Clip Rating [A]		Cat. No.
	250V	600V	
H/J	30	-	1494U-FC302J
	60	30	1494U-FC30J
	-	60	1494U-FC60J
	100	100	1494U-FC100J
R	30	-	1494U-FC302R
	60	30	1494U-FC30R
	-	60	1494U-FC60R
	100	100	1494U-FC100R

Trailer Fuse Block Kits

Disconnect Switch Size [A]	Cat. No.
30	1494U-F30
60	1494U-F60
100	1494U-F100



Product Selection Tools

Available online or for download, our tools help you access info while in the office or on the go.

<https://rok.auto/selection>

Drives



1-72...1-77

For more information on our complete family of circuit protection products, please visit:
<https://rok.auto/circuit-load-protection>



Disconnect Switches



Visible Blade Disconnect Switches 1494V Variable Depth

- 200...600 A, 3-pole, 600V AC ratings
- Rod-operated, flange-mounted handle
- Fusible or non-fusible versions
- Lockable handle
- Visible blade construction for safety

Visible Blade Disconnect Switches 1494C Cable Operated

- 200...600 A, 3-pole, 600V AC ratings
- Cable operation allows flexible mounting within the panel
- Fusible or non-fusible versions
- Lockable handle
- Visible blade construction for safety



Application Spotlight

Bulletin 1494 disconnect switches are time proven, robust design with visible blade construction that is the product of choice in automotive manufacturing applications.

Circuit
Breakers



1-2...1-15

**Disconnect
Switches**



1-16...1-23

Control &
Load Switches



1-24...1-27

Contactors



1-28...1-41

Starters



1-42...1-55

Motor
Protection



1-56...1-61

Smart
Motor Control



1-62...1-71

Product Selection

1494V Visible Blade Disconnect Switch Components

Continuous Current Rating [A] 600V AC, 250V DC	NEMA, UL, CSA Maximum Rating Hp		IEC Utilization Category AC-23 Maximum Rating kW		Rod Operated	
	3-Phase, 60 Hz		3-Phase, 50 Hz		Switch with Right-Hand Mechanism	Switch with Left-Hand Mechanism
	200...208V	460V	220...240V	380...440V	Cat. No.	Cat. No.
200	50...60	125	48	90	1494V-DS200	1494V-DSX200
400	75	250	90	185	1494V-DS400	1494V-DSX400
600	150	400	150	295	1494V-DS600 ¹	

1494C Visible Blade Disconnect Switch Components

Continuous Current Rating [A] 600V AC, 250V DC	NEMA, UL, CSA Maximum Rating Hp		IEC Utilization Category AC-23 Maximum Rating kW		Cable Operated	
	3-Phase, 60 Hz		3-Phase, 50 Hz		Switch with Right-Hand Mechanism	Switch with Left-Hand Mechanism
	200...208V	460V	220...240V	380...440V	Cat. No.	Cat. No.
200	50...60	125	48	90	1494F-D200	1494F-DX200
400	75	250	90	185	1494F-D400	1494F-DX400
600	150	400	150	295	1494V-DS600 ¹	

¹ Switch can be converted in the field for left-hand operation.

Cable Mechanisms for 1494C Disconnect Switch

Disconnect Switch Size [A]	Cable Length [ft]	Right-Hand Cable Mechanisms	Left-Hand Cable Mechanisms
		Cat. No.	Cat. No.
200	4	1494C-CM5	1494C-CMX5
	5	1494C-CM6	1494C-CMX6
	6	1494C-CM7	1494C-CMX7
	10	1494C-CM8	1494C-CMX8
400	4	1494C-CM9	1494C-CMX9
	5	1494C-CM10	1494C-CMX10
	6	1494C-CM11	1494C-CMX11
	10	1494C-CM12	1494C-CMX12
600	4	1494C-CM13	1494C-CMX13
	5	1494C-CM14	1494C-CMX14
	6	1494C-CM15	1494C-CMX15
	10	1494C-CM16	1494C-CMX16

Connecting Rods for 1494V Disconnect Switches

Disconnect Switch Size [A]	Enclosure Depth [in. (mm)] ²		Cat. No.
	Minimum	Maximum	
200	6-3/4 (172)	9-1/8 (232)	1494V-RA3
	6-3/4 (172)	21-5/8 (549)	1494V-RA4
400, 600	9-1/2 (241)	10 (254)	1494V-RB3 ³
	9-1/2 (241)	23 (584)	1494V-RB4 ³

² Enclosure depth is measured from the top of the flange to the disconnect switch mounting surface.

³ Kit includes two connecting rods.

Trailer Fuse Block Kits for 1494V & 1494C

Disconnect Switch Size [A]	Cat. No.
200	1494V-FS200
400	1494V-FS400
600	1494V-FS600

Fuse Clip Kits for 1494V & 1494C

Fuse Class	Fuse Clip Rating [A]		Cat. No. ⁴
	250V	600V	
J	200	200	1401-N45
	400	400	1401-N46
	600	600	⁵

⁴ Includes six clips and mounting hardware.

⁵ Fuse clips not required: fuse bolts directly to terminal.

Operating Handles for 1494V & 1494C

Handle Type ⁶	Description	Disconnect Switch Size [A]	Cat. No.
Type 1, 3R, 4, 4X, 12	Nonmetallic	200	1494F-P1
		400, 600	1494F-M1
Type 1, 3R, 4, 12	Painted Metal	200	1494F-M2
		400, 600	1494F-S1
Type 4, 4X	Stainless Steel	200	1494F-S2
		400, 600	

⁶ Right or left flange mounting available.

Drives



For more information on our complete family of circuit protection products, please visit:
<https://rok.auto/circuit-load-protection>



Control & Load Switches

POWER

Control & Load Switches 194L

- Available in ON-OFF, changeover, star-delta (wye-delta), reversing, ammeter, voltmeter and step switch configurations
- Front door, Base/DIN Rail mounting configurations
- 1-6-pole versions
- Enclosed products available up to 25 A
- Padlockable handles available (up to 3 padlocks)



Switch Body



Shaft



Handle



N Style



G Style



I Style



A Style

Bulletin 194L Control & Load Switches are designed for use as manual motor controllers and at motor disconnects.



IP66 enclosure, shaft and handle are orderable as components.

Handles (Includes OFF-ON legend plate and control knob)

Type (for front or base mounting)	With Legend Plate 0-1, 48 x 48 mm	With Legend Plate 0-1, 67 x 67 mm
	Cat. No.	Cat. No.
A - Standard switch	194L-HE4A-175	194L-HE6A-175
G - Disconnect switch	194E-HE4G-175	194L-HE6G-175
I - Emergency stop	194L-HE4I-175	194L-HE6I-175
N - Disconnect switch/Emergency stop	194E-HE4N-175	194L-HE6N-175

Control & Load Switches

Circuit
Breakers



1-2...1-15

Disconnect
Switches



1-16...1-23



1-24...1-27

Contactors



1-28...1-41

Starters



1-42...1-55

Motor
Protection



1-56...1-61

Smart
Motor Control



1-62...1-71

Product Selection

194L Switch Bodies, ON-OFF

Function	I AC-21A [A]	Poles	Front/Door Mounting	Base/DIN Rail Mounting
			Cat. No. ¹	Cat. No. ¹
	12	1	194L-E12-1751	194L-A12-1751
		2	194L-E12-1752	194L-A12-1752
		3	194L-E12-1753	194L-A12-1753
	16	1	194L-E16-1751	194L-A16-1751
		2	194L-E16-1752	194L-A16-1752
		3	194L-E16-1753	194L-A16-1753
	20	1	194L-E20-1751	194L-A20-1751
		2	194L-E20-1752	194L-A20-1752
		3	194L-E20-1753	194L-A20-1753
	25	1	194L-E25-1751	194L-A25-1751
		2	194L-E25-1752	194L-A25-1752
		3	194L-E25-1753	194L-A25-1753

¹ To change number of poles, change final number to **1, 2, 3** or **4**.

194L Switch Bodies, Changeover Switches

Function	I AC-21A [A]	Poles	Front/Door Mounting
			Cat. No.
	12	3	194L-E12-3503
		4	194L-E12-3504
	16	3	194L-E16-3503
		4	194L-E16-3504
	20	3	194L-E20-3503
		4	194L-E20-3504
	25	3	194L-E25-3503
		4	194L-E25-3504

194L Switch Bodies, Changeover Switches 2

Function	I AC-21A [A]	Poles	Front/Door Mounting
			Cat. No.
	12	3	194L-E12-2503
	16		194L-E16-2503
	20		194L-E20-2504
	25		194L-E25-2503

² With both 0-1 and OFF/ON inscriptions.

Enclosed Control & Load Switches

For Use With	Number of Contacts	IP66 Enclosure, ABS Material	Required Shaft for ABS	IP66 Enclosure, Noryl Material	Required Shaft for Noryl
		Cat. No.	Cat. No.	Cat. No.	Cat. No.
194L-A12/16	1...2	194L-G3572	194L-G3195	194L-G3576	194L-G3195
	3...4	194L-G3572	194L-G2830	194L-G3576	194L-G2830
	5...6	194L-G3573	194L-G3195	194L-G3577	194L-G3195
194L-A20/25	1...2	194L-G3572	194L-G3194	194L-G3576	194L-G3194
	3...4	194L-G3572	194L-G2830	194L-G3576	194L-G2830
	5...6	194L-G3573	194L-G3194	194L-G3577	194L-G3194

Drives



1-72...1-77

For more information on our complete family of control and load switch products, please visit:
<https://rok.auto/control-load-switches>



Control & Load Switches

POWER

Load Switches 194E

- Base/DIN Rail, or front-door mounting configurations
- Available in OFF-ON and changeover configurations
- 3- and 6-pole switches
- Enclosed products available up to 100 A
- Padlockable handles available (up to 3 padlocks)

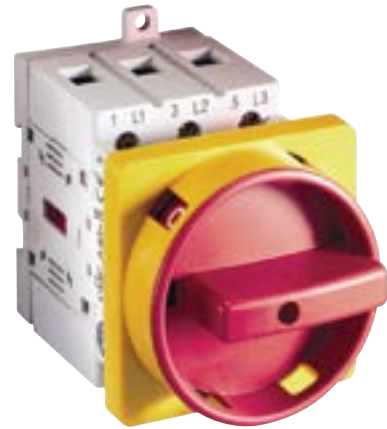

Bulletin 194E load switches are suitable as motor disconnect or other load switch applications.



Handle Options

Available as front mounting/DIN mounting

194E
16...100 A



N Style



G Style



I Style



A Style

Enclosed Load Switches

Base/DIN Rail Mounting Only





Stainless steel

Non-metallic





Thermoplastic

Control & Load Switches

Circuit Breakers



1-2...1-15

Disconnect Switches



1-16...1-23



1-24...1-27

Contactors



1-28...1-41

Starters



1-42...1-55

Motor Protection



1-56...1-61

Smart Motor Control



1-62...1-71

Product Selection

OFF-ON 3-Pole Switch (includes operating shaft)

Function	I AC-21A [A]	Front/Door Mounting	Base/DIN Rail Mounting
		Cat. No.	Cat. No.
	16	194E-E16-1753	194E-A16-1753
	25	194E-E25-1753	194E-A25-1753
	32	194E-E32-1753	194E-A32-1753
	40	194E-E40-1753	194E-A40-1753
	63	194E-E63-1753	194E-A63-1753
	80	194E-E80-1753	194E-A80-1753
	100	194E-E100-1753	194E-A100-1753

OFF-ON 6-Pole Switch (includes operating shaft)

Function	I AC-21A [A]	Front/Door Mounting	Base/DIN Rail Mounting
		Cat. No.	Cat. No.
	16	194E-E16-1756	194E-A16-1756
	25	194E-E25-1756	194E-A25-1756
	32	194E-E32-1756	194E-A32-1756
	40	194E-E40-1756	194E-A40-1756
	63	194E-E63-1756	194E-A63-1756
	80	194E-E80-1756	194E-A80-1756
	100	194E-E100-1756	194E-A100-1756

Enclosed Load Switches, 3-Pole

Description	Rated Operational Current [A]	Cat. No.
Enclosed Switches	16	194E-◆A16 ¹
	25	194E-◆A20 ¹
	32	194E-◆A32 ¹
	40	194E-◆A40 ¹
	63	194E-◆A63 ¹
	80	194E-◆A80 ¹
	100	194E-◆A00 ¹
Thermoplastic enclosure, IP66	16	194E-Y16-1753-4N ²
	25	194E-Y25-1753-6N ²
	32	194E-Y32-1753-6N ²
	40	194E-Y40-1753-6N ²

¹ Catalog number shown is for black handle. To order a red/yellow handle, add an **E** to the end of the catalog number.

² Catalog number shown is for red/yellow handle.

◆ The catalog number as listed is incomplete. Select an enclosure type code from the table below.

◆ Enclosure Type

Code	Description
C, D	Stainless steel enclosure, IP66, UL Type 4/4X, Hinged
K	Non-metallic enclosure, IP66, UL Type 4/4X
A	Painted steel, IP54, Type 1, Hinged
F, G	Painted steel, IP66, Type 3/4/12, Hinged

Handles (Includes OFF-ON legend plate and control knob)

Type (for front or base mounting)	Up to 16 A	25...100A
	Cat. No.	Cat. No.
A Standard switch	194L-HE4A-175	194E-HE6A-175
G Disconnect switch	194E-HE4G-175	194E-HE6G-175
I Emergency Stop	194L-HE4I-175	194E-HE6I-175
N Disconnect switch/Emergency stop	194E-HE4N-175	194E-HE6N-175

Accessories

Auxiliary Contacts	Cat. No.	For Use With
1 N.O. + 1 N.C.	194E-A-P11	194E-A16...100
	194E-E-P11	194E-E16...100
1 N.O. + 1 N.C.L.B.	194E-A-PL11	194E-A16...100
	194E-E-PL11	194E-E16...100
2 N.O. + 2 N.C.	194E-A-P22	194E-A16...100
	194E-E-P22	194E-E16...100
1 N.O.E.B.	194E-A16-PD10	194E-A16
	194E-A-PD10	194E-A25...100
	194E-E16-PD10	194E-E16
	194E-E-PD10	194E-E25...100
Additional Pole, 1 N.O.	Neutral Terminal	For Use With
194E-A16-NP	194E-A16-TN	194E-A16
194E-A25-NP	194E-A32-TN	194E-A25
194E-A32-NP	194E-A32-TN	194E-A32
194E-A40-NP	194E-A63-TN	194E-A40
194E-A63-NP	194E-A63-TN	194E-A63
194E-A80-NP	194E-A100-TN	194E-A80
194E-A100-NP	194E-A100-TN	194E-A100
194E-E16-NP	194E-E16-TN	194E-E16
194E-E25-NP	194E-E32-TN	194E-E25
194E-E32-NP	194E-E32-TN	194E-E32
194E-E40-NP	194E-E63-TN	194E-E40
194E-E63-NP	194E-E63-TN	194E-E63
194E-E80-NP	194E-E100-TN	194E-E80
194E-E100-NP	194E-E100-TN	194E-E100

Drives



For more information on our complete family of control and load switch products, please visit:
<https://rok.auto/control-load-switches>



Contactors

POWER

Miniature IEC Contactors 100-K/104-K

- Designed for commercial and light industrial applications
- 5...12 A
- Compact size with fewer panel depth and height requirements
- Full-voltage non-reversing and reversing contactors
- Same dimensions for AC and DC



Miniature IEC contactors can be used on the compact bus bar mounting system as shown below.¹

140MT Motor Protection
Circuit Breaker

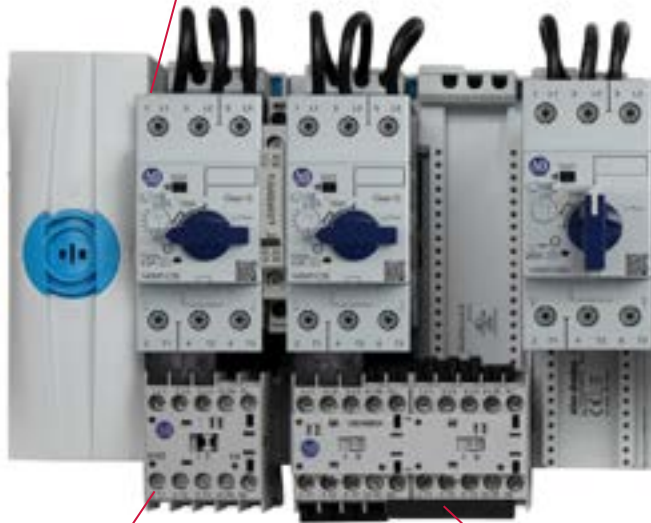

100-K Miniature Contactor

104-K Reversing
Miniature Contactor

Accessories²



Auxiliary contact
block

Reversing wiring kit



Mechanical interlock



Connecting
module



Surge suppressor
modules

² Additional details on accessories can be found on page 1-32.

¹ Additional details on the 141 Mounting Systems can be found on page 1-77.

Circuit
Breakers



1-2...1-15

Disconnect
Switches



1-16...1-23

Control &
Load Switches



1-24...1-27

Contactors



1-28...1-41

Starters



1-42...1-55

Motor
Protection



1-56...1-61

Smart
Motor Control



1-62...1-71

Product Selection

AC- and DC-Control Miniature Contactors ¹

Rated Operational Current [A]		Ratings for Switching AC Motors			Power Poles		Aux. Contacts		Direct-on-Line	
		3-Phase kW	3-Phase Hp						Screw Terminal	Spring Clamp
AC-3	AC-1	400/415V	200/230V	460/575V	N.O.	N.C.	N.O.	N.C.	Cat. No.	Cat. No.
3-pole										
5	20	2.2	1-1/2	3	3	0	1	0	100-K05⊗10	100-KR05⊗10
							0	1	100-K05⊗01	100-KR05⊗01
9	20	4	2	5			1	0	100-K09⊗10	100-KR09⊗10
							0	1	100-K09⊗01	100-KR09⊗01
12	20	5.5	3	7-1/2			1	0	100-K12⊗10	-
							0	1	100-K12⊗01	-
4-pole										
5	20	2.2	1-1/2	3	4	0	0	0	100-K05⊗400	-
					2	2	0	0	100-K05⊗200	-
9	20	4	2	5	4	0	0	0	100-K09⊗400	-
					2	2	0	0	100-K09⊗200	-
12	20	5.5	3	7-1/2	4	0	0	0	100-K12⊗400	-
					2	2	0	0	100-K12⊗200	-

⊗ The catalog number as listed is incomplete. Select a coil voltage code from the table below.

¹ Additional details on accessories can be found on page 1-32.

⊗ Coil Voltage Codes for AC and DC Control

AC Control	
Code	Description
KJ	24V, 50/60 Hz
D	110V, 50 Hz/120V, 60 Hz
KF	230V, 50/60 Hz
KA	240V, 50/60 Hz

DC Control	
Code	Description
DJ	24V, Integrated diode
ZJ	24V, Standard

For more coil voltage codes, please visit <https://rok.auto/directory>.



Product Certifications

Global certifications available online:

<https://rok.auto/certifications>

Drives



For more information on our complete family of IEC contactor products, please visit: <https://rok.auto/iec-contactors>



Contactors

POWER

IEC Contactors 100-C/104-C

- 9...97 A
- Environmentally friendly materials
- Low-consumption AC or DC coils
- Common accessories for all contactor sizes



Flexible Starter Configurations

Three Component Starter



Two Component Starter



Short Circuit Protection Provided Separately

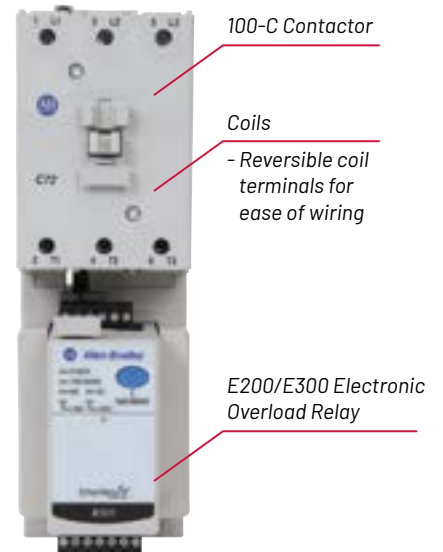

Multiple mounting methods available:

- Panel mount
- DIN Rail
- Bus bar



Circuit Breakers



1-2...1-15

Disconnect Switches



1-16...1-23

Control & Load Switches



1-24...1-27

Contactors



1-28...1-41

Starters



1-42...1-55

Motor Protection



1-56...1-61

Smart Motor Control



1-62...1-71

Product Selection

AC- and DC-Operated Contactors ³

Rated Operational Current [A]		Ratings for Switching AC Motors – AC-2, AC-3			Direct-on-Line			Reversing		
		3-Phase kW	3-Phase Hp		Auxiliary Contacts ^{1,2}		Cat. No.	Auxiliary Contacts installed per contactor		Cat. No.
AC-3	AC-1	400/415V	200/230V	460/575V	N.O.	N.C.		N.O.	N.C.	
3-pole, Screw Terminals										
9	32	4	5	7-1/2	1	0	100-C09⊗10	1	1	104-C09⊗22
12	32	5.5	7-1/2	10	1	0	100-C12⊗10	1	1	104-C12⊗22
16	32	7.5	10	15	1	0	100-C16⊗10	1	1	104-C16⊗22
23	32	11	15	15	1	0	100-C23⊗10	1	1	104-C23⊗22
30	65	15	20	25	0	0	100-C30⊗00	1	1	104-C30⊗22
37	65	18.5/20	25	30	0	0	100-C37⊗00	1	1	104-C37⊗22
43	85	22	30	30	0	0	100-C43⊗00	1	1	104-C43⊗22
55	85	30	40	40	0	0	100-C55⊗00	1	1	104-C55⊗22
60	100	32	40	50	0	0	100-C60⊗00	1	1	104-C60⊗22
72	100	40	50	60	0	0	100-C72⊗00	1	1	104-C72⊗22
85	100	45	60	60	0	0	100-C85⊗00	1	1	104-C85⊗22
97	130	55	75	75	0	0	100-C97⊗00	1	1	104-C97⊗22

⊗ The catalog number as listed is incomplete. Select a coil voltage code from the table below.

¹ To add an N.O. auxiliary contact, the catalog number can be changed from 100C-C30⊗00 to 100C-C30⊗10.

² To add an N.C. auxiliary contact, the catalog number can be changed from 100C-C30⊗00 to 100C-C30⊗01.

³ Additional details on accessories can be found on page 1-32.

⊗ Coil Voltage Codes for AC and DC Control

AC Control		DC Control with Integrated Surge Suppression	
Code	Description	Code	Description
KJ	24V, 50/60 Hz	DJ	24V (60...97 A only)
D	110V, 50 Hz/120V, 60 Hz	EJ	24V, Electronic (9...55 A only)
KF	230V, 50/60 Hz	ED	110V, Electronic (9...55 A only)
G	400-415V, 50 Hz		
L	200-220V 50 Hz / 208-240V 60 Hz		

For more coil voltage codes, please visit <https://rok.auto/directory>.



Global Short Circuit Current Ratings Selection Tool

Try out the Global SCGR Selection Tool, providing coordinated high fault branch circuit solutions for motor starters, soft starters and component drives.

<https://rok.auto/sccr>

Drives



1-72...1-77

For more information on our complete family of IEC contactor products, please visit: <https://rok.auto/iec-contactors>



Contactors

Accessories

100-K Miniature Contactors

Description	Auxiliary Contacts		Spring Clamp Cat. No.	Screw Terminals Cat. No.
	N.O.	N.C.		
Front-mounted auxiliary contacts	0	2	100-KRFC02	100-KFC02
	1	1	100-KRFC11	100-KFC11
	2	0	100-KRFC20	100-KFC20
	2	2	100-KRFC22	100-KFC22
	3	1	100-KRFC31	100-KFC31
	4	0	100-KRFC40	100-KFC40

Description	Cat. No.	
RC suppressor	24...48V AC	100-KFSC50
	110...280V AC	100-KFSC280
	380...480V AC	100-KFSC480
MOV surge suppressor	12...55V AC, 12...77V DC	100-KFSV55
	56...136V AC, 78...180V DC	100-KFSV136
	137...277V AC, 181...250V DC	100-KFSV277
Diode surge suppressor	12...250V DC	100-KFSD250
Mechanical interlock	100-KMCH	
Power wiring kit- for reversing and start/delta combinations	100-KPR	
ECO connecting module for electrical and mechanical connection to a 140M-T motor protection circuit breaker - 12 A	140M-T-PEK12	



Sales Offices and Distributors

Our network of sales offices and distributors offers exceptional knowledge and service to help you design, implement and support your automation investment.

<https://rok.auto/buy>

Circuit
Breakers



1-2...1-15

Disconnect
Switches



1-16...1-23

Control &
Load Switches



1-24...1-27

Contactors



1-28...1-41

Starters



1-42...1-55

Motor
Protection



1-56...1-61

Smart
Motor Control



1-62...1-71



Accessories

100-C Contactors with Screw Terminals

Description	Auxiliary Contacts		Screw Terminals Cat. No.
	N.O.	N.C.	
Front-mounted auxiliary contacts	0	2	100-FA02
	1	1	100-FA11
	2	0	100-FA20
	2	2	100-FA22
	3	1	100-FA31
	4	0	100-FA40
Side-mounted auxiliary contacts	0	1	100-SB01
	1	0	100-SB10
	0	1	100-SB11
	2	0	100-SB20

Surge Suppressors		Cat. No.
RC Module	24...48V AC, 50/60 Hz	100-FSC48
	110...280V AC, 50/60 Hz	100-FSC280
	380...480V AC, 50/60 Hz	100-FSC480
MOV Surge Suppressor	12...55V AC, 12...77V DC	100-FSV55
	56...136V AC, 78...180V DC	100-FSV136
	137...277V AC, 181...250V DC	100-FSV277

Mechanical Interlock	For Use With	Cat. No.
Mechanical only, without aux contacts	100-C (except 100C-40... C90)	100-MCA00
Mechanical/electrical, with 2 N.C. aux contacts		100-MCA02

Timing Modules	For Use With	Cat. No.
Pneumatic Timing Modules: Contacts switch after the delay time, main control relay contacts continue to operate without delay	On-Delay 0.3...30 s Range	100-C w/ AC Coils or DC Electronic Coils
	On-Delay 2...180 s Range	
Electronic Timing Modules: Delay of the contactor or control relay solenoid, contactor or control relay is energized at the end of the delay time	On-Delay 0.1...3 s Range	100-C w/ 110...240V, 50/60 Hz or 110...250V conventional DC coils
	On-Delay 1...30 s Range	
	On-Delay 10...180 s Range	
	On-Delay 0.1...3 s Range	100-C w/ 24...48V conventional DC coils
	On-Delay 1...30 s Range	

Reversing Power Wiring Kit	For Use With	Cat. No.
For reversing connection with a solid-state or thermal overload relay	100-C09...C23	105-PW23
	100-C30...C37	105-PW37
	100-C43...C55	105-PW55
	100-C60...C97	105-PW85

Drives



1-72...1-77

For more information on our complete family of IEC contactor products, please visit:
<https://rok.auto/iec-contactors>



Contactors

POWER

IEC Contactors 100-E/104-E

- 9...2650 A
- Compact size for smaller panel space requirements
- Wide range electronic coils for reduced energy consumption
- Environmentally friendly



The Bulletin 100-E/104-E contactor family offers wide range AC/DC electronic coils for reduced energy consumption and a compact design.

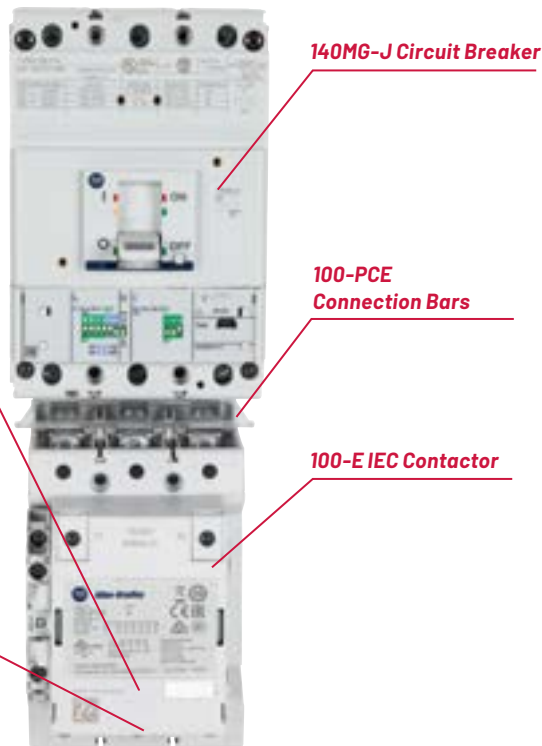

Optional 24V DC PLC Interface

- Separate hold-in auxiliary contact not required
- Optional on 100-E116...E370 contactors
- Standard on all 100-E400...E2650 contactors
- 200-220V 50 Hz / 208-240V 60 Hz

Optional built-in terminal lugs

- Finger-safe protection
- Allows for 2 wires per pole
- For contactors up to 146A

⊗ Coil Voltage Codes for AC and DC Control

AC/DC Control	
Electronic Standard Coils, 100-E09...E370	
Code	Description
KJ	24...60V 50-60 Hz, DC
KD	100...250V 50-60 Hz, DC
KN	250...500V 50-60 Hz, DC
Electronic Coils with PLC Interface, 100-E116...E370	
Code	Description
ED	100...250V 50-60 Hz, DC
EN	250...500V 50-60 Hz, DC
Electronic Coils with PLC Interface, 100-E400...E750, E1260	
Code	Description
EJ	24...60V DC ¹
ED	100...250V 50-60 Hz, DC
EN	250...500V 50-60 Hz, DC
Electronic Coils with PLC Interface, 100-E860, E1060, E2050, E2650	
Code	Description
ED	100...250V 50-60 Hz, DC

¹ Also available for 100-E09...E38

Circuit Breakers



1-2...1-15

Disconnect Switches



1-16...1-23

Control & Load Switches



1-24...1-27

Contactors



1-28...1-41

Starters



1-42...1-55

Motor Protection



1-56...1-61

Smart Motor Control



1-62...1-71



Safety Contactors 100S-C/104S-C, 100S-E

- 9...750 A
- SUVA third party certification
- AC and DC operating coils
- Mechanically linked or mirror contact performance

POWER

Safety contactors provide mechanically linked, or mirror, contact performance, which is required in feedback circuits monitoring energy isolating switchgear used in hazardous motion loads.

Red contact housing for easy identification

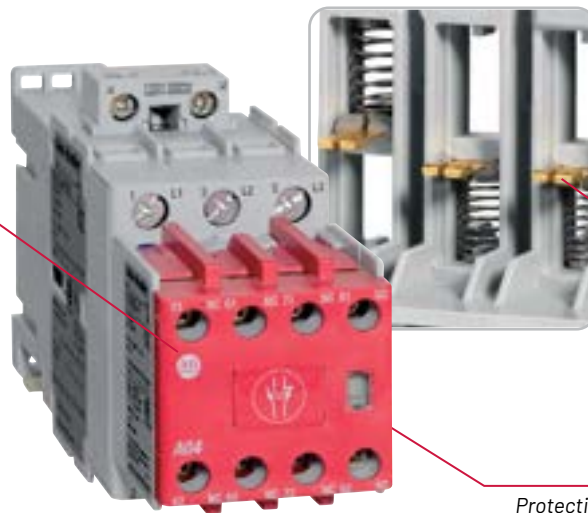

Gold plated, bifurcated contacts for improved signal reliability

Protective cover prevents manual operation

100S-C Safety Contactor

Certifications (100S-C)

- CE Marked
- cULus Listed (File No. E3125; Guide NLDX, NLDX7)
- CCC

Certifications (100S-E)

- CE Marked
- cULus Listed (File No. E41850; Guide NLDX, NLDX7)
- SUVA Certified
- CCC

Drives



1-72...1-77

For more information on our complete family of IEC contactor products, please visit:
<https://rok.auto/iec-contactors>



Contactors

Product Selection

100-E/104-E Contactors – 3-Pole AC- and DC-operated Direct-on-line Contactors

Rated Operational Current I _e [A]		Ratings for switching AC motors - AC-2, AC-3											Auxiliary Contacts		Cat No.
60 °C	40 °C	kW (50 Hz)							Hp (60 Hz)				N.O.	N.C.	
AC-3 (400V)	AC-1 (690V)	220-240V	380-400V	415V	440V	500V	690V	1000V	200V	230V	460V	575V			
9	25	2.2	4	4	4	5.5	5.5	–	2	2	5	7.5	1	0	100-E09⊗10
													0	1	100-E09⊗01
12	28	3	5.5	5.5	5.5	7.5	7.5	–	3	3	7.5	10	1	0	100-E12⊗10
													0	1	100-E12⊗01
16	30	4	7.5	9	9	9	9	–	5	5	10	15	1	0	100-E16⊗10
													0	1	100-E16⊗01
26	45	6.5	11	11	15	15	15	–	7.5	7.5	15	20	0	0	100-E26⊗00
32	50	9	15	15	18.5	18.5	18.5	–	10	10	20	25	0	0	100-E30⊗00
38	50	11	18.5	18.5	22	22	22	–	10	10	25	30	0	0	100-E38⊗00
40	70	11	18.5	22	22	22	22	–	10	15	30	40	0	0	100-E40⊗00
52	100	15	22	30	30	30	30	–	15	20	40	50	0	0	100-E52⊗00
65	105	18.5	30	37	37	37	37	–	20	25	50	60	0	0	100-E65⊗00
80	125	22	37	45	45	45	45	35	25	30	60	75	0	0	100-E80⊗00
96	130	25	45	55	55	55	55	40	30	30	60	75	0	0	100-E96⊗00

AC/DC Operated Contactors

Rated Operational Current [A]		Ratings for Switching AC Motors - AC-2, AC-3			Direct-on-Line Contactors			Reversing Contactors		
AC-3	AC-1	3-Phase kW (50 Hz)	3-Phase Hp (60 Hz)		Auxiliary Contacts ¹		Cat. No.	Auxiliary Contacts ¹ installed per contactor		Cat. No.
400V	690V		400V	460V	575V	N.O.		N.C.	N.O.	
116	160	55	75	100	1	1	100-E116⊗11 ¹	2	2	104-E116⊗22 ¹
146	225	75	100	125	1	1	100-E146⊗11 ¹	2	2	104-E146⊗22 ¹
190	275	90	125	150	1	1	100-E190⊗11	2	2	104-E190⊗22
205	350	110	150	200	1	1	100-E205⊗11	2	2	104-E205⊗22
265	400	132	200	250	1	1	100-E265⊗11	2	2	104-E265⊗22
305	500	160	250	300	1	1	100-E305⊗11	2	2	104-E305⊗22
370	600	200	300	350	1	1	100-E370⊗11	2	2	104-E370⊗22
400	600	200	350	400	1	1	100-E400⊗11	2	2	104-E400⊗22
460	700	250	400	500	1	1	100-E460⊗11	2	2	104-E460⊗22
580	800	315	500	600	1	1	100-E580⊗11	2	2	104-E580⊗22
750	1050	400	600	700	1	1	100-E750⊗11	2	2	104-E750⊗22
860	1350	475	800	1000	1	1	100-E860⊗11	–	–	–
1060	1650	560	900	1150	1	1	100-E1060⊗11	–	–	–
–	1260	–	–	–	1	1	100-E1260⊗11	–	–	–
–	2050	–	–	–	1	1	100-E2050⊗11	–	–	–
–	2650	–	–	–	1	1	100-E2650⊗11	–	–	–

⊗ The catalog number as listed is incomplete. Select a coil voltage code from the table to the left.

¹ To order with built-in terminal lugs, add the letter "L" to the end of the catalog number (e.g. 100-E116⊗11L).

Circuit Breakers



1-2...1-15

Disconnect Switches



1-16...1-23

Control & Load Switches



1-24...1-27

Contactors



1-28...1-41

Starters



1-42...1-55

Motor Protection



1-56...1-61

Smart Motor Control



1-62...1-71

Product Selection

100-E/104-E Contactors – 3-Pole AC- and DC-operated Reversing Contactors

Rated Operational Current I_e [A]		Ratings for switching AC motors – AC-2, AC-3											Auxiliary Contacts		Cat No.
60 °C	40 °C	kW (50 Hz)							Hp (60 Hz)				N.O.	N.C.	
AC-3 (400V)	AC-1 (690V)	220-240V	380-400V	415V	440V	500V	690V	1000V	200V	230V	460V	575V			
9	25	2.2	4	4	4	5.5	5.5	–	2	2	5	7.5	0	1	104-E09⊗02
													1	1 ¹	104-E09⊗22 ²
12	28	3	5.5	5.5	5.5	7.5	7.5	–	3	3	7.5	10	0	1	104-E12⊗02
													1	1 ¹	104-E12⊗22 ²
16	30	4	7.5	9	9	9	9	–	5	5	10	15	0	1	104-E16⊗02
													1	1 ¹	104-E16⊗22 ²
26	45	6.5	11	11	15	15	15	–	7.5	7.5	15	20	0	1 ¹	104-E26⊗02 ²
													1	1	104-E26⊗22
32	50	9	15	15	18.5	18.5	18.5	–	10	10	20	25	0	1 ¹	104-E30⊗02 ²
													1	1	104-E30⊗22
38	50	11	18.5	18.5	18.5	22	22	–	10	10	25	30	0	1 ¹	104-E38⊗02 ²
													1	1	104-E38⊗22
40	70	11	18.5	22	22	22	22	–	10	15	30	40	1	1	104-E40⊗22
52	100	15	22	30	30	30	30	–	15	20	40	50	1	1	104-E52⊗22
65	105	18.5	30	37	37	37	37	–	20	25	50	60	1	1	104-E65⊗22
80	125	22	37	45	45	45	45	35	25	30	60	75	1	1	104-E80⊗22
96	130	25	45	55	55	55	55	40	30	30	60	75	1	1	104-E96⊗22

¹ The N.C. auxiliary contact is supplied as part of the mechanical/electrical interlock.

² For AC control voltages only.

100S-C Safety Contactors

Rated Operational Current [A]		Ratings for switching AC motors			Auxiliary Contacts		No. of Poles	AC Coil Control Cat. No. ¹
AC-3	AC-1	3-Phase kW (50 Hz)	3-Phase Hp (60 Hz)		N.O.	N.C.		
		400/415V	460V	575V				
9	32	4	5	7 1/2	1	4	3	100S-C09⊗14BC
12	32	5.5	7-1/2	10	1	4	3	100S-C12⊗14BC
16	32	7.5	10	15	1	4	3	100S-C16⊗14BC
23	32	11	15	15	1	4	3	100S-C23⊗14BC
30	65	15	20	25	1	4	3	100S-C30⊗14BC
37	65	18.5/20	25	30	1	4	3	100S-C37⊗14BC
43	85	22	30	30	1	4	3	100S-C43⊗14BC
55	85	30	40	40	1	4	3	100S-C55⊗14BC
60	100	32	40	50	1	4	3	100S-C60⊗14BC
72	100	40	50	60	1	4	3	100S-C72⊗14BC
85	100	45	60	60	1	4	3	100S-C85⊗14BC
97	130	55	75	75	1	4	3	100S-C97⊗14BC

⊗ The catalog number as listed is incomplete. Select a coil voltage code from the table below.

¹ For additional contact configurations, please visit our online product directory. BC = bifurcated and C = standard.

Drives



For more information on our complete family of IEC contactor products, please visit:
<https://rok.auto/iec-contactors>



CONTACTORS

Product Selection

100S-E Safety Contactors – 3-Pole AC- and DC-operated Safety Contactors

Rated Operational Current I_n [A]		Ratings for switching AC motors - AC-2, AC-3											Auxiliary Contacts			Direct-on-line
60 °C	40 °C	kW (50 Hz)							Hp (60 Hz)				N.O.	N.C.	N.C. ¹	Contactor
AC-3 (400V)	AC-1 (690V)	220-240V	380-400V	415V	440V	500V	690V	1000V	200V	230V	460V	575V				
9	25	2.2	4	4	4	5.5	5.5	—	2	2	5	7.5	1	0	4	100S-E09⊗14C
12	28	3	5.5	5.5	5.5	7.5	7.5	—	3	3	7.5	10	1	0	4	100S-E12⊗14C
16	30	4	7.5	9	9	9	9	—	5	5	10	15	1	0	4	100S-E16⊗14C
26	45	6.5	11	11	15	15	15	—	7.5	7.5	15	20	2	0	2	100S-E26⊗22C
32	50	9	15	15	18.5	18.5	18.5	—	10	10	20	25	2	0	2	100S-E30⊗22C
38	50	11	18.5	18.5	22	22	22	—	10	10	25	30	2	0	2	100S-E38⊗22C
40	70	11	18.5	22	22	22	22	—	10	15	30	40	2	0	2	100S-E40⊗22C
52	100	15	22	30	30	30	30	—	15	20	40	50	2	0	2	100S-E52⊗22C
65	105	18.5	30	37	37	37	37	—	20	25	50	60	2	0	2	100S-E65⊗22C
80	125	22	37	45	45	45	45	35	25	30	60	75	2	0	2	100S-E80⊗22C
96	130	25	45	55	55	55	55	40	30	30	60	75	2	0	2	100S-E96⊗22C

¹ The N.C. contact meets IEC 60947-4-1 Annex F requirements for mirror contact performance.

100S-E Safety Contactors

Rated Operational Current [A]		Ratings for switching AC motors			Auxiliary Contacts			No. of Poles	Cat. No. ²
AC-3	AC-1	3-Phase kW (50 Hz)		3-Phase Hp (60 Hz)	N.O.	N.C.	N.C. ³		
400V	690V	400V	460V	575V					
116	160	55	75	100	1	1	1	3	100S-E116⊗12C ²
146	225	75	100	125	1	1	1	3	100S-E146⊗12C ²
190	275	90	125	150	1	1	1	3	100S-E190⊗12C
205	350	110	150	200	1	1	1	3	100S-E205⊗12C
265	400	132	200	250	1	1	1	3	100S-E265⊗12C
305	500	160	250	300	1	1	1	3	100S-E305⊗12C
370	600	200	300	350	1	1	1	3	100S-E370⊗12C
400	600	200	350	400	1	1	1	3	100S-E400⊗12C
460	700	250	400	500	1	1	1	3	100S-E460⊗12C
580	800	315	500	600	1	1	1	3	100S-E580⊗12C
750	1050	400	600	700	1	1	1	3	100S-E750⊗12C

⊗ The catalog number as listed is incomplete. Select a coil voltage code from the table below.

² To order with built-in terminal lugs, add the letter "L" to the end of the catalog number (e.g. 100-E116⊗11L).

³ The N.C. contact meets IEC 60947-4-1 Annex F requirements for mirror contact performance.

⊗ Coil Voltage Codes for AC and DC Control

AC Control, 100S-C	
Code	Description
KJ	24V, 50/60 Hz
D	110V, 50 Hz/ 120V, 60 Hz
KF	230V, 50/60 Hz

DC Control, 100S-C	
Code	Description
EJ	24V, Electronic coils (9...55 A only)
DJ	24V, Integrated diode (60...97 A only)

AC/DC Control, 100S-E	
Code	Description
Electronic Standard Coils, 100S-E09...E370	
KJ	24...60V 50-60 Hz, DC
KD	100...250V 50-60 Hz, DC
KN	250...500V 50-60 Hz, DC
Electronic Coils with PLC Interface, 100S-E116...E370	
ED	100...250V 50-60 Hz, DC
EN	250...500V 50-60 Hz, DC

AC/DC Control, 100S-E	
Code	Description
Electronic Coils with PLC Interface, 100S-E400...E750, E1260	
EJ	24...60V DC ¹
ED	100...250V 50-60 Hz, DC
EN	250...500V 50-60 Hz, DC
Electronic Coils with PLC Interface, 100S-E860, E1060, E2050, E2650	
ED	100...250V 50-60 Hz, DC
L	200-220V 50 Hz / 208-240V 60 Hz

Circuit Breakers



1-2...1-15

Disconnect Switches



1-16...1-23

Control & Load Switches



1-24...1-27

CONTACTORS



1-28...1-41

Starters



1-42...1-55

Motor Protection



1-56...1-61

Smart Motor Control



1-62...1-71

Accessories

Auxiliary Contact Blocks with Standard Auxiliary Contacts

Description	N.O.	N.C.	For Use With	Cat. No.
Auxiliary Contact Blocks for Front Mounting <ul style="list-style-type: none"> 1-pole Quick and easy mounting without tools Screw connection terminals Switching down to 12V, 3mA Mirror contact performance to the main contactor poles L= Late break N.C./early make N.O. 	1	0	100-E09... 100-E96	100-EFA10
	0	1		100-EFA01
Auxiliary Contact Blocks for Side Mounting <ul style="list-style-type: none"> 2-pole Two-way numbering for right or left mounting on the contactor With or without sequence terminal designations Quick and easy mounting without tools Screw connecting terminals Switching down to 12V, 3mA Mirror contact performance to the main contactor poles 	1	1	100-E26... 100-E96	100-ESB11

Mechanical Interlocks

Description		For Use With	Cat. No.
Mechanical Interlock <ul style="list-style-type: none"> For interlocking of two contactors Two fixing clips included 	Mechanical only, without auxiliary contacts	100-E09... 100-E38 (3 pole), 100-E09⊗400... 100-E38⊗400	100-EMCA00A
		100-EMCA00B	
Mechanical and Electrical Interlock <ul style="list-style-type: none"> For interlocking of two contactors Two fixing clips, a mechanical interlock and an electrical interlock block with A2 – A2 connection included Front-face connection of the electrical interlock block connects the 2 built-in N.C. interlocking contacts with the two coils The electrical diagram is used with the A2-A2 connection 	Mechanical/ electrical interlock	100-E40... 100-E96 (3 pole), 100-E40⊗400... 100-E80⊗400	100-EMCA02

Side Mounted Auxiliary Contacts

Description	For Use With	Mtg. Position	N.O.	N.C.	Cat. No.
Standard contacts <ul style="list-style-type: none"> Left or right side mtg. Min. switching 24V 50 mA 	100-E116...E370	Inside	1	1	100-ES1-11
		Outside	1	1	100-ES2-11
	100-E400... E2650	Inside	1	1	100-ES3-11
		Outside	1	1	100-ES4-11
Standard contacts <ul style="list-style-type: none"> Left or right side mtg. Min. switching 3V 1 mA 	100-E116...E370	Inside	1	-	100-ES1-B10
		Inside	-	1	100-ES1-B01
	100-E400... E2650	Inside	1	-	100-ES3-B10
		Inside	-	1	100-ES3-B01

Terminal Lugs

Description	For Use With	Cat. No.
Terminal Lug Kit (set of two)	100-E116...E146	100-ECL146
Terminal Lugs (set of three)	100-E190...E205	100-ETL205
	100-E265...E370	100-ETL370
		100-ETL370B ²
	100-E400...E460	100-ETL580
	100-E580...E1250	100-ETL750
	100-E860	100-ETL860
100-ETL1060		
	100-ETL1060B ³	

² Accepts 2 conductors.

³ Accepts 6 conductors.

Mechanical Interlock

Description	For Use With	Cat. No.
For interlocking two contactors	100-E116...E370	100-EM1-00
	100-E400...E2650	100-EM2-00

Drives



1-72...1-77

For more information on our complete family of IEC contactor products, please visit:
<https://rok.auto/iec-contactors>



Contactors

POWER

Definite-Purpose Contactors 400

- 1...4 pole options, 25...120 A resistive loads
- Feed-through wiring
- Double-break contacts
- Snap-on auxiliary contacts
- Rated for inductive lighting and resistive loads



Stationary Terminal

One piece terminal design with integral dual 0.250 quick connects. Meets NEMA Standard for spacing without insulated terminals.



Base Assembly

High arc-resistant polyester hold stationary terminals, positions actuator, and magnet/coil assembly.

Exclusive Terminal Screw

Hex, Slotted, Phillips, screw, #10-32 SEM's. Box lugs standard on 40 FLA models and larger.

Applications

- Air conditioners
- Compressors
- Welding equipment
- Business machines
- Power supplies
- Refrigeration equipment
- Resistive heating
- Food service equipment



1-40

Circuit Breakers



1-2...1-15

Disconnect Switches



1-16...1-23

Control & Load Switches



1-24...1-27

Contactors



1-28...1-41

Starters



1-42...1-55

Motor Protection



1-56...1-61

Smart Motor Control



1-62...1-71

Product Selection

400 Definite-Purpose Contactors

Full Load Amps [A]	No. of Poles	Max. Continuous Ampere Rating [A]		Line Voltage [V]	Locked Rotor Current [A]	Resistive Current Rating [A]	Control Voltage [V]	Max. [Hp]		Cat. No.
		Tungsten Lamp Loads ¹	Ballast Lighting Load					1-Phase	3-Phase	
20/25	2	25		240/277	150	35	120	2	-	400-DP25N⊗2
				480	125	35	240	3	-	
				600	100			3	-	
	3	25		240/277	150	35	110/120	2	5	400-DP25N⊗3⊕
				480	125	35	240/277	5	10	
				600	100	35	480	-	15	
30	2	30		240/277	150	40	120	2	-	400-DP30N⊗2
				480	125	40	240	3	-	
				600	100			3	-	
	3	30		240/277	180	40	110/120	2	5	400-DP30N⊗3⊕
				480	150	40	240/277	5	10	
				600	150	40	480	-	15	
40	2	40		240/277	240	50	120	-	-	400-DP40N⊗2
				480	200	50	240	-	-	
				600	120	50	240	-	-	
40	3	-		240/277 480 600	240 200 120	50 50 50	110/120	-	-	400-DP40N⊗3
							200/208	-	-	
							240/277	-	-	
							480	-	-	
							600	-	-	

¹ Max. 480V line, 277V load.

⊕ The catalog number as listed is incomplete. Select coil voltage code from the table.

★ Factory-installed Modifications

Description	Suffix Code
Auxiliary contact - 1 N.O./1 N.C. with QC for 3-pole - 20/25 and 30 A only	-AB5
Auxiliary contact - SPDT with QC for 3-pole - 20/25 and 30 A only	-A5
Auxiliary contact - 2 SPDT with QC for 3-pole - 20/25 and 30 A only	-AA5

⊗ AC Coil Voltage Codes

Code	Description
J	24V
D	120V
A	208/240V
F	277V
B	480V

Accessories

Description	Cat. No.
Arc covers for 20/25 and 30 A - 2-pole	400-C2
Mechanical interlock kit	20/25...40 A, 3-pole 400-MK1
DIN Rail adapter	20/25...40 A, 1-...4-pole 400-DRA
Auxiliary contact	1 N.O./1 N.C. w/QCs 400-AB1
	SPDT w/QCs 400-A1
	2-SPDT w/QCs 400-B2

Sales Offices and Distributors

Our network of sales offices and distributors offers exceptional knowledge and service to help you design, implement and support your automation investment.

<https://rok.auto/buy>



Drives



1-72...1-77

For more information on our complete family of NEMA contactor products, please visit:
<https://rok.auto/nema-contactors>



Starters

POWER

Manual Motor Low Voltage Starters 600, 609, 609U, 609TU

- Undervoltage protection
- Manual operation with overload protection
- Ideal for low HP applications, up to 10 HP three phase



Manual motor starters are specifically designed for full voltage motor starting applications where remote push button control is not necessary. They are ideally suited for starting and protecting smaller motors frequently used for fans and blowers.

600 Manual Starting Switches



- Single phase
- Starting and overload protection of small AC/DC motors up to 1 Hp

609 Manual Starting Switches



- Single and three phase
- Contact position indicator
- Locking feature
- Reversing and 2-speed
- Wide range of enclosures, including hazardous location



609U & 609TU Manual Starting Switches

- Undervoltage protection
- Single and three phase
- Contact position indicator
- Locking feature
- Wide range of enclosures
- Push button or toggle switch

1-42

Circuit Breakers



1-2...1-15

Disconnect Switches



1-16...1-23

Control & Load Switches



1-24...1-27

Contactors



1-28...1-41

Starters



1-42...1-55

Motor Protection



1-56...1-61

Smart Motor Control



1-62...1-71

Product Selection

600 Manual Motor Starters

Type	No. of Poles	Open Type Without Enclosure Includes Legend Plate	Type 1 General Purpose Enclosure Surface Mount	Type 1 General Purpose Enclosure Flush Mount Includes Flush Plate Only
Switch Only				
Toggle	1	600-TOX4	600-TAX4	600-TQX4
	2	600-TOX5	600-TAX5	600-TQX5
Key	2	600-TOX49	600-TAX49	600-TQX49
Lever	1	600-TOX149	600-TAX149	-
Switch with Neon Pilot Light (115 or 230V)				
Toggle	1	600-TOX216	600-TAX216	600-TQX216
	2	600-TOX109	600-TAX109	600-TQX109
Key	2	600-TOX110	600-TAX110	600-TQX110
Switch and Hand-Off-Auto Selector Switch (for use on AC only)				
Toggle	2	-	600-TAX9	600-TQX9
Switch with Neon Pilot Light and Hand-Off-Auto Selector Switch (115 or 230V, AC only)				
Toggle	2	-	600-TAX142	600-TQX142
Key	2	-	600-TAX145	-

609 Manual Motor Starters

Type	Phase	Size	Max. Hp Rating				Open Type without Enclosure	Type 1 General Purpose Enclosure Surface Mount
			Motor Voltage, 60 Hz					
			115V	200V	230V	460...575V	Cat. No.	Cat. No.
Push Button	1	0	1	-	2	-	609-AOX	609-AAX
		1	2	-	3	-	609-BOX	609-BAX
		1P	3	-	5	-	609-XOX	609-XAX
Toggle Lever	3	0	-	3	3	5	609-AOW	609-AAW
		1	-	7-1/2	7-1/2	10	609-BOW	609-BAW
Toggle Lever	1	0	1	-	2	-	609T-AOX	609T-AAX
		1	2	-	3	-	609T-BOX	609T-BAX
		1P	3	-	5	-	609T-XOX	609T-XAX
	3	0	-	3	3	5	609T-AOW	609T-AAW
		1	-	7-1/2	7-1/2	10	609T-BOW	609T-BAW

Heater Elements – All single-phase starters require one heater element and three-phase starters require three heater elements.

Product selection for 609U & 609TU is available at <https://rok.auto/lv-starters>

Drives



1-72...1-77

For more information on our complete family of IEC starter products, please visit: <https://rok.auto/lv-starters>



Starters

POWER

IEC Eco Starters 190E/191E

- 5...23 A
- Type 1 and 2 coordination
- AC or DC coils available
- Shares common accessories with 100-C/100-K contactors and 140M motor protection circuit breakers



The 190E/191E motor controllers can be used in a variety of applications. These starters can be used in a group motor application or as a stand-alone product without any additional short-circuit protection in the motor branch circuits. Rated Type F combination motor controllers (UL/CSA).

Options for Field Assembly

190/191-E starters can be field assembled. Simply select the following:

- 100-K/104-K miniature contactor (page 1-28) or 100-C/104-C contactor (page 1-30)
- 140MT motor protection circuit breaker (page 1-3)
- Eco connecting module

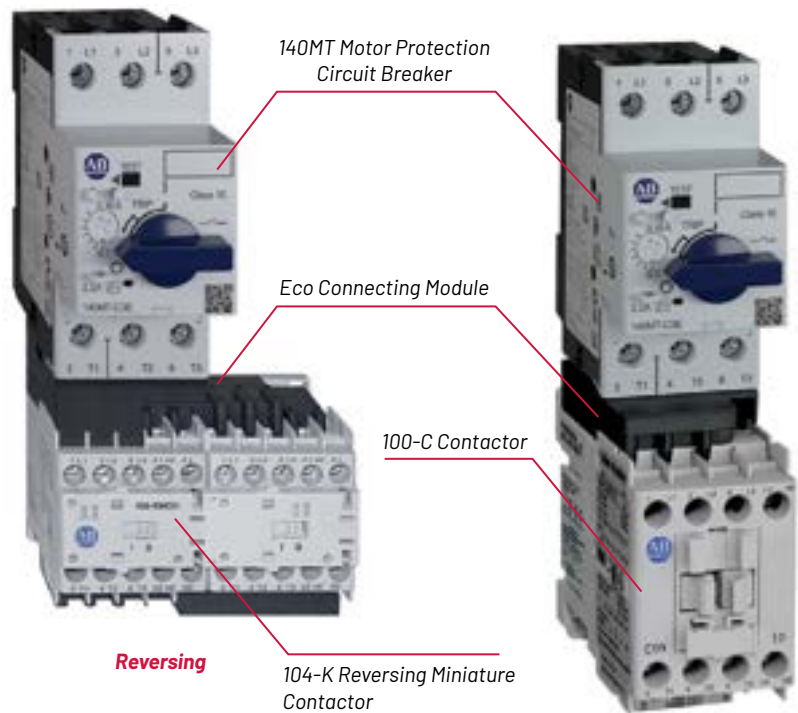

Direct-on-Line

Circuit Breakers



1-2...1-15

Disconnect Switches



1-16...1-23

Control & Load Switches



1-24...1-27

Contactors



1-28...1-41

Starters



1-42...1-55

Motor Protection



1-56...1-61

Smart Motor Control



1-62...1-71

Product Selection

IEC Eco Starters with AC and DC-Operated Contactors

Motor Current Adjustment Range [A]	3-Phase kW (50 Hz)	3-Phase Hp (60 Hz)	Max. Short-Circuit Current Type 1 Coordination [kA]	With 100-K IEC Miniature Contactors		With 100-C IEC Contactors	
				Direct-on-Line Cat. No.	Reversing Cat. No.	Direct-on-Line Cat. No.	Reversing Cat. No.
0.10...0.16	0.02	-	65	190E-KMN⊗2-CA16X	191E-KMN⊗1-CA16X	190E-AN⊗2-CA16X	191E-AN⊗3-CA16X
0.16...0.25	0.06	-	65	190E-KMN⊗2-CA25X	191E-KMN⊗1-CA25X	190E-AN⊗2-CA25X	191E-AN⊗3-CA25X
0.25...0.40	0.09	-	65	190E-KMN⊗2-CA40X	191E-KMN⊗1-CA40X	190E-AN⊗2-CA40X	191E-AN⊗3-CA40X
0.40...0.63	0.12...0.18	-	65	190E-KMN⊗2-CA63X	191E-KMN⊗1-CA63X	190E-AN⊗2-CA63X	191E-AN⊗3-CA63X
0.63...1.00	0.25	0.5	65	190E-KMN⊗2-CB10X	191E-KMN⊗1-CB10X	190E-AN⊗2-CB10X	191E-AN⊗3-CB10X
1.00...1.60	0.37...0.55	0.5...1	65	190E-KMN⊗2-CB16X	191E-KMN⊗1-CB16X	190E-AN⊗2-CB16X	191E-AN⊗3-CB16X
1.60...2.50	0.75	0.75...1.5	65	190E-KMN⊗2-CB25X	191E-KMN⊗1-CB25X	190E-AN⊗2-CB25X	191E-AN⊗3-CB25X
2.50...4.00	1.1...1.5	1.5...3	65	190E-KMN⊗2-CB40X	191E-KMN⊗1-CB40X	190E-AN⊗2-CB40X	191E-AN⊗3-CB40X
4.00...6.30	2.2	3...5	65	190E-KNN⊗2-CB63X	191E-KNN⊗1-CB63X	190E-AN⊗2-CB63X	191E-AN⊗3-CB63X
6.30...10.0	3.0...4.0	5...7.5	65	190E-KPN⊗2-CC10X	191E-KPN⊗1-CC10X	190E-BN⊗2-CC10X	191E-BN⊗3-CC10X
10.0...11.0	5.5	7.5	30	190E-KPN⊗2-CC16X	191E-KPN⊗1-CC16X	-	-
10.0...12.0	4.0...5.5	7.5	30	-	-	190E-BN⊗2-CC16X	191E-BN⊗3-CC16X
10.0...16.0	5.5...6.3	7.5...10.0	30	-	-	190E-CN⊗2-CC16X	191E-CN⊗3-CC16X

⊗ The catalog number as listed is incomplete. Select a coil voltage code from the table below.

Accessories

Description	For Use With	Cat. No.
ECO Connecting Modules - 25 A	140MT-C to 100-C09...C23	140M-C-PEC23

POWER

⊗ Coil Voltage Codes for AC and DC Control

AC Control		24V DC Control	
Code	Description	Code	Description
KJ	24V, 50/60 Hz	ZJ	Standard (190E/191E-K)
D	110V, 50 Hz/120V, 60 Hz	DJ	Integrated diode (190E/191E-K)
KF	230V, 50/60 Hz	EJ	Electronic with integrated diode (190/191E-A...D)



Product Selection Tools

Available online or for download, our tools help you access info while in the office or on the go.

<https://rok.auto/selection>

Drives



1-72...1-77

For more information on our complete family of IEC starter products, please visit: <https://rok.auto/lv-starters>



Starters

POWER

Enclosed Starters, IEC 109-C/105-C

- Reversing and non-reversing
- Electronic motor protection
- Non-combination, disconnecting means to be provided separately
- Factory modifications available



Compact Installation

Plastic enclosures provide a compact, cost effective solution to help reduce machine space and expand product flexibility.

100-C Contactor



E1 Plus Electronic Overload Relay

Wiring Made Easy

Metal enclosures now feature component wiring color-coded by function. The wiring sleeve-cover corresponds to a colored label on the terminal block, reducing wiring errors and allowing for quicker installation times.

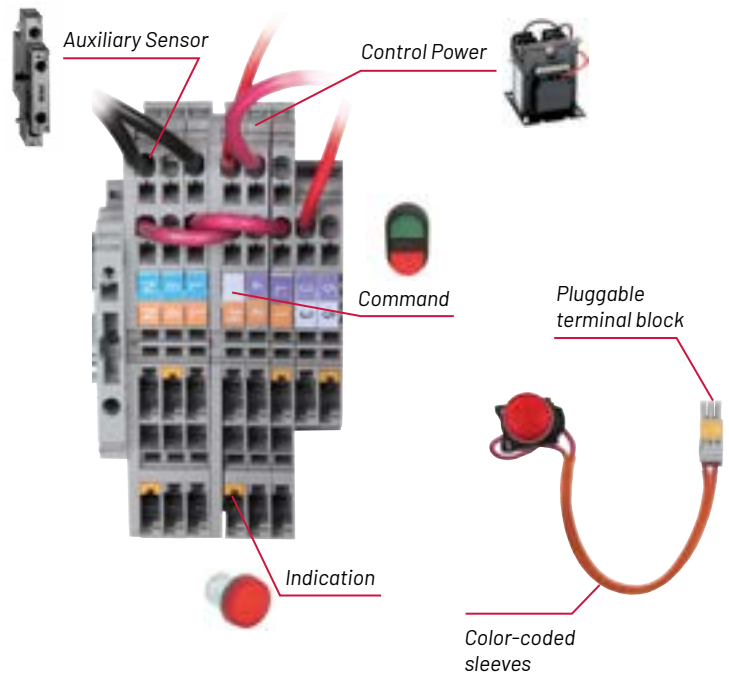

1-46

Circuit Breakers



1-2...1-15

Disconnect Switches



1-16...1-23

Control & Load Switches



1-24...1-27

Contactors



1-28...1-41

Starters



1-42...1-55

Motor Protection



1-56...1-61

Smart Motor Control



1-62...1-71

Product Selection

IEC Enclosed Starters, Plastic

Type		Direct-on-Line Starter ² 109-C	Reversing 105-C
Ratings AC-3	E1 Plus ¹ Overload Relay	IP66, Type 4/4X/12, Molded Plastic	IP66, Type 4/4X/12, Molded Plastic
Amps	Motor Current Setting Range		With FORWARD/OFF/REVERSE Multifunction Push Button (3 Functions) and Reset
[A]	[A]	Cat. No.	Cat. No.
9	1.0...5.0	109-C09K⊗E1C-⊕	105-C09L⊗E1C-1M-7
9	3.2...16.0	109-C09K⊗E1D-⊕	105-C09L⊗E1D-1M-7
12	3.2...16.0	109-C12K⊗E1D-⊕	105-C12L⊗E1D-1M-7
16	3.2...16.0	109-C16K⊗E1D-⊕	105-C16L⊗E1D-1M-7
23	5.4...27.0	109-C23K⊗E1E-⊕	105-C23L⊗E1E-1M-7
30	9.0...45.0	109-C30L⊗E1F-1M-7 ³	-
37	9.0...45.0	109-C37L⊗E1F-1M-7 ³	-
43	9.0...45.0	109-C43L⊗E1F-1M-7 ³	-

¹ For Eutectic Alloy Overload Relay, please visit <https://rok.auto/directory>.

² For other enclosure types, please visit <https://rok.auto/directory>.

³ With START/STOP Multifunction Push Button (2 Functions) and Reset.

⊗ The catalog number as listed is incomplete. Select a coil voltage code from the table to the right.

⊕ The catalog number as listed is incomplete. Replace with start and stop (1) or reset (7).

⊗ Coil Voltage Codes for AC and DC Control

AC Control	
Code	Description
KJ	24V, 50/60 Hz
D	110V, 50 Hz/120V, 60 Hz
KF	230V, 50/60 Hz

DC Control with Integrated Surge Suppression	
Code	Description
DJ	24V (60...97 A only)
EJ	24V, Electronic (9...55 A only)
ED	110V, Electronic (9...55 A only)

IEC Enclosed Starters, Metal ⁴

Amps	Max. Hp Rating				Cat. No.	
	3-Phase				Type 1 (IP42)	
	200V AC	230V AC	460V AC	575V AC	Non-reversing	Reversing
9	2	2	5	7 1/2	109-C09AD-OLR	105-C09AD-OLR
12	3	3	7 1/2	10	109-C12AD-OLR	105-C12AD-OLR
16	5	5	10	15	109-C16AD-OLR	105-C16AD-OLR
23	5	7 1/2	15	15	109-C23AD-OLR	105-C23AD-OLR
30	7 1/2	10	20	25	109-C30AD-OLR	105-C30AD-OLR
37	10	10	25	30	109-C37AD-OLR	105-C37AD-OLR

⁴ All starters come standard with a 120V AC coil.

Electronic Overload Relays

IEC Contactor	Overload Relay FLA Range [A]	Three-phase Cat. No.
109-C09...109-C23	0.1...0.5	193-EEAB
	0.2...1.0	193-EEBB
	1.0...5.0	193-EECB
	5.4...27	193-EEEB
109-C30...109-C55	5.4...27	193-EEED
	9...45	193-EEFD
	11...55	193-EEQD
External reset adapter is required		193-ERA

Snap-together Accessory Kits

Kit Description	Cat. No.
Push Button, Start-Stop	198-SSPB ⁵
Selector Switch, Plastic, HOA/FOR	198-3SS
Push Button, For-Rev-Stop	198-FRSPB ⁶
Pilot Light, 24...120V AC/DC, Red LED	198-RUPL
Pilot Light, 24...120V AC/DC, Green LED	198-GUPL
Pilot Light, 24...120V AC/DC, White LED	198-WUPL
N.O./N.C. Auxiliary contact kit	198-SA11 ⁵
208/120V AC transformer kit	1497-HD50 ⁷
240/120V AC transformer kit	1497-AD50 ⁷
480/120V AC transformer kit	1497-BD50 ⁷
600/120V AC transformer kit	1497-CD50 ⁷

⁵ Can only be used with non-reversing starters and contactors.

⁶ Can only be used with reversing starters.

⁷ Transformer kits are pre-engineered with fuses and fuse covers.

Drives



1-72...1-77

For more information on our complete family of IEC starter products, please visit:
<https://rok.auto/lv-starters>



Starters

POWER

Combination Starters, IEC 112/113

- 112 with fusible and non-fusible disconnect switches 113 with circuit breakers
- Non-reversing and reversing
- IP42 (Type 1) and IP66 (Type 3/4/12) enclosures
- Padlockable handle for up to three padlocks



These full-voltage combination starters are designed to provide the disconnecting means, short-circuit protection (with suitable fuses), control and overload protection for three-phase squirrel-cage motors. All starters include a normally open auxiliary contact as standard.

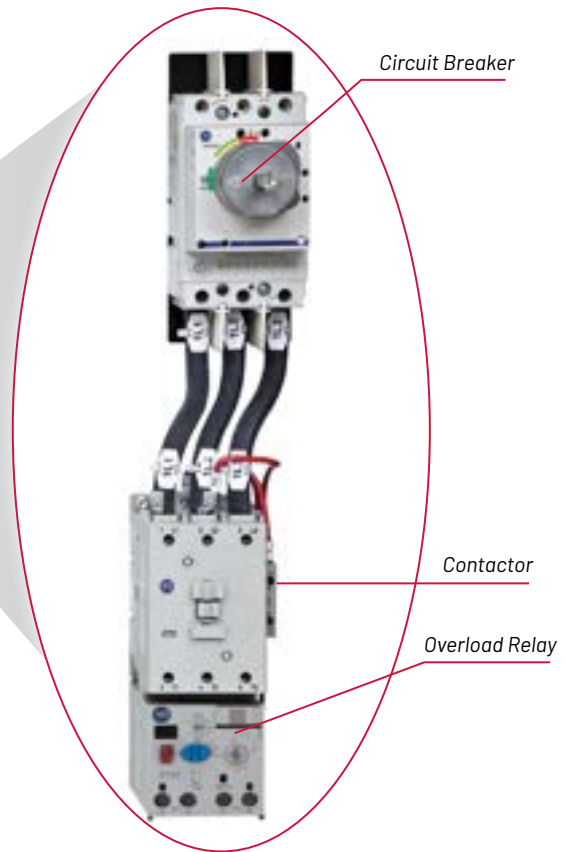

Enclosures

- IP42 (Type 1) general purpose sheet metal (hinged cover)
- IP66 (Type 3/4/12) watertight, dusttight sheet metal (hinged cover)

1-48

Circuit Breakers



1-2...1-15

Disconnect Switches



1-16...1-23

Control & Load Switches



1-24...1-27

Contactors



1-28...1-41

Starters



1-42...1-55

Motor Protection



1-56...1-61

Smart Motor Control



1-62...1-71

Product Selection

IEC Combination Starters, Non-Reversing

Ratings (AC3, AC4)			IP42 (Type 1) General Purpose Sheet Metal Enclosure (Hinged Cover)			IP66 (Type 3/4/12) Watertight, Dusttight Sheet Metal Enclosure (Hinged Cover)		
Max. I _e [A]	Hp		Fusible Disconnect Type ¹		Circuit Breaker Type	Fusible Disconnect Type ¹		Circuit Breaker Type
	230V	460V	Fuse Clip Rating/ UL Class	Cat. No.	Cat. No.	Fuse Clip Rating/ UL Class	Cat. No.	Cat. No.
9	2	5	30 A/Class J	112-C09A⊗⊕	-	30 A/Class J	112-C09F⊗⊕	-
12	3	7.5	30 A/Class J	112-C12A⊗⊕	-	30 A/Class J	112-C12F⊗⊕	-
23	7.5	15	30 A/Class J	112-C23A⊗⊕	-	30 A/Class J	112-C23F⊗⊕	-
30	10	20	60 A/Class J	112-C30A⊗⊕	113-C30A⊗⊕-□	60 A/Class J	112-C30F⊗⊕	113-C30F⊗⊕-□
43	15	30	60 A/Class J	112-C43A⊗⊕	113-C43A⊗⊕-□	60 A/Class J	112-C43F⊗⊕	113-C43F⊗⊕-□
60	20	40	100 A/Class J	112-C60A⊗⊕	113-C60A⊗⊕-□	100 A/Class J	112-C60F⊗⊕	113-C60F⊗⊕-□
72	25	50	100 A/Class J	112-C72A⊗⊕	113-C72A⊗⊕-□	100 A/Class J	112-C72F⊗⊕	113-C72F⊗⊕-□

⊗ The catalog number as listed is incomplete. Select a coil voltage code, circuit breaker code, and overload relay code from the tables below.

¹ Non-fusible versions also available.

□ Circuit Breaker Code

Code	Max. Hp	Code	Max. Hp	Code	Max. Hp	Code	Max. Hp
33	0.5	39	5	43	20	50	100
35	1	40	7.5	44	25	51	125
36	1.5	41	10	45	30	52	150
38	3	42	15	48	60	54	200

⊕ Overload Relay Code

Full Load Current Range [A]	3-Phase Overload Relay Code
0.1...0.5	E1A
0.2...1.0	E1B
1.0...5.0	E1C
3.2...16	E1D
5.4...27	E1E
9.0...45	E1F
18...90	E1G

⊗ Coil Voltage Codes for AC and DC Control

AC Control		DC Control with Integrated Surge Suppression	
Code	Description	Code	Description
KJ	24V, 50/60 Hz	DJ	24V (60...97 A only)
D	110V, 50 Hz/120V, 60 Hz	EJ	24V, Electronic (9...55 A only)
KF	230V, 50/60 Hz	ED	110V, Electronic (9...55 A only)
KA	240V, 50/60 Hz		

Modifications

Description	Suffix Code
START-STOP push button	1
Hand-Off-Auto selector switch	3
Red pilot light	4R

Drives



1-72...1-77

For more information on our complete family of IEC starter products, please visit:
<https://rok.auto/lv-starters>



Starters

POWER

Space-Saving NEMA Full Voltage Starters 300

- NEMA sizes 0...8
- Energy-saving, universal coil design covers wide-range of AC and DC control voltages (sizes 4...8)
- Solid-state overload relay (direct mount through size 4)
- Panel or DIN rail mounts available
- Safety versions available (sizes 4...8)



Approximate size of traditional NEMA contactor 7 x 13.39 in., 178 x 340 mm (W x L)

The Allen-Bradley® Bulletin 300 NEMA Contactors and motor starters provide a space-saving and cost-effective alternative for applications requiring NEMA-rated motor control. Based on our Bulletin 100 IEC Contactor design these NEMA-rated products are compatible with a wide range of accessories as well as solid-state overload relays.



Compatible with full range of Bulletin 100C/E accessories for wide selection

Compact design saves panel space

Bulletin 300 Size 5
5.51 x 8.86 in., 140 x 225 mm (W x L)
actual size 30% smaller

Energy-saving, wide range AC/DC current coils (sizes 4...8)

1-50

Circuit Breakers



1-2...1-15

Disconnect Switches



1-16...1-23

Control & Load Switches



1-24...1-27

Contactors



1-28...1-41

Starters



1-42...1-55

Motor Protection



1-56...1-61

Smart Motor Control



1-62...1-71

Product Selection

3-Pole AC/DC Operated Contactors and Starters

NEMA Size	Continuous Current Rating (A)	Switching of 3-phase Motors – AC-2, AC-3				Auxiliary Contacts Each Contactor		Bulletin 300 Direct On-line Contactor	Bulletin 305 Reversing Starter	Bulletin 309 Starter	Safety Contactor
		Hp (60 Hz)				N.O.	N.C.				
		200 V	230 V	460 V	575 V						
0	18	3	3	5	5	1	-	300-A0⊗930	305-A0⊗-⊕	309-A0⊗-⊕	•
1	27	7.5	7.5	10	10	1	-	300-B0⊗930	305-B0⊗-⊕	309-B0⊗-⊕	•
2	45	10	15	25	25	1	-	300-C0⊗930	305-C0⊗-⊕	309-C0⊗-⊕	•
3	90	25	30	50	50	1	-	300-D0⊗930	305-D0⊗-⊕	309-D0⊗-⊕	•
4	135	40	50	100	100	1	1	300-E0⊗9311 ¹	305-E0⊗-⊕	309-E0⊗-⊕	300S-E0⊗9312C ¹
5	270	75	100	200	200	1	1	300-F0⊗9311	-	-	300S-F0⊗9312C
6	540	150	200	400	400	1	1	300-G0⊗9311	-	-	300S-G0⊗9312C
7	810	250	300	600	600	1	1	300-H0⊗9311	-	-	300S-H0⊗9312C
8	1215	-	450	900	900	1	1	300-J0⊗9311	-	-	300S-J0⊗9312C

⊗ The catalog number as listed is incomplete. Select a control voltage code from the tables below.

⊕ The catalog number as listed is incomplete. Select a overload relay code from the table below.

Example: **Cat. No. 305-A0D-⊕** becomes **Cat. No. 305-A0D-EEC**.

¹ To order with built-in terminal lugs, add the letter "L" to the end of the catalog number (for example, **300-E0⊗9311-L**).

⊗ Coil Voltage Codes and Terminal Position (NEMA Sizes 0...3)

	[V]	24	110	120	220	240	277	440	480	550	600
NEMA Size 0...3	AC, 50 Hz	K ²	D	P ²	A	T ²	-	B	-	C	-
	AC, 60 Hz	J ²	-	D	-	A	T ²	-	B	-	C
	AC, 50/60 Hz	KJ	-	-	-	KA ²	-	-	-	-	-
NEMA Size 0...2	DC	EJ	-	-	-	-	-	-	-	-	-
NEMA Size 3	DC	DJ ²	-	-	-	-	-	-	-	-	-

² Bulletin 300 contactors only

³ 24...60V DC only.

⊗ Coil Voltage Codes (NEMA sizes 4...8)

Electronic Coils with PLC Interface	[V]	24...60	48...130	100...250	250...500
NEMA Size 4...5	AC/DC	J	Y	D	B
NEMA Size 4...5	AC/DC with PLC Input	-	-	ED	EN
NEMA Size 6...7		EJ ³	EY	ED	EN
NEMA Size 8		-	-	ED	-

⊕ E1 Plus Overload Relay (Bulletin 305, 309, NEMA Sizes 0...4)

NEMA Size	Adjustment Range [A]	Overload Relay Code
0	1.0...5	EEC
0...1	5.4...27	EEE
2	9...45	EEF
3	18...90	EEG
4	30...150	A2M

Drives



For more information on our complete family of IEC starter products, please visit:
<https://rok.auto/lv-starters>



Starters

POWER

NEMA Full-Voltage Starters 509 Heavy Duty Industrial 309 Space and Energy Saving

- NEMA sizes 00...5
- Available as a modular kit for faster delivery
- Includes a 120V AC coil and (1) N.O. auxiliary contact as standard
- Solid-state overload relays: Class 10, 15, 20, and 30
- Snap-together wiring available on lift-off enclosures
- Enclosure rating: Type 1, 3R/12, 4/4X stainless steel, and 7 & 9



The 509 NEMA Starters are designed for full-voltage starting of polyphase squirrel-cage motors. These starters are available for constant horsepower, constant torque or variable torque, three-phase motors.

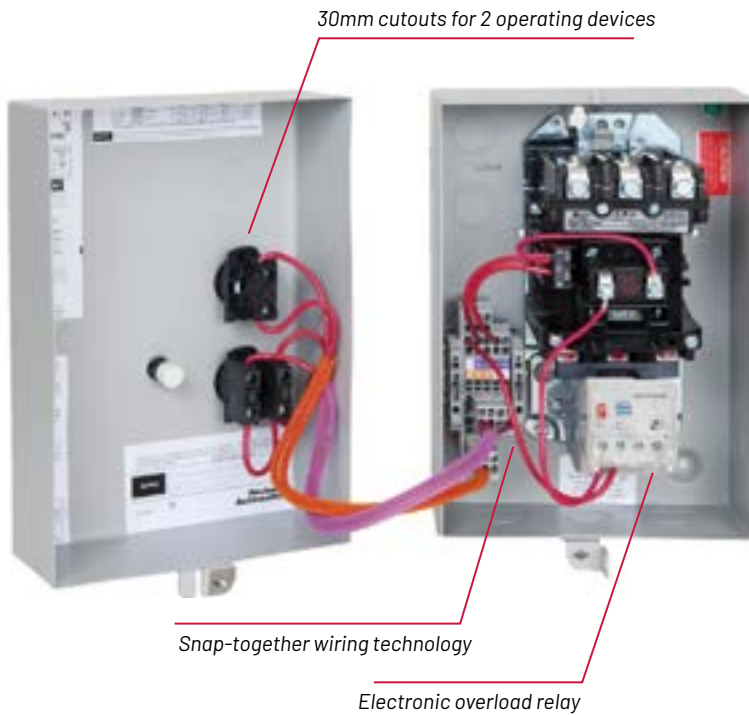

509 Enclosed Starter

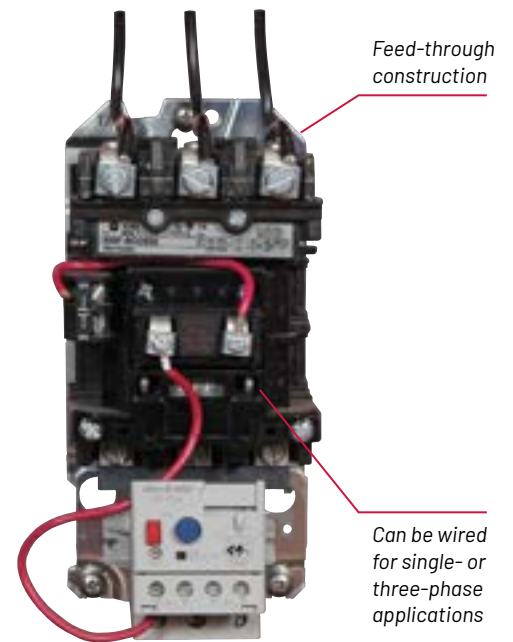

509 Open Starter

1-52

Circuit Breakers



1-2...1-15

Disconnect Switches



1-16...1-23

Control & Load Switches



1-24...1-27

Contactors



1-28...1-41

Starters



1-42...1-55

Motor Protection



1-56...1-61

Smart Motor Control



1-62...1-71

Product Selection

NEMA Reversing and Non-reversing Starters and Contactors¹

NEMA Size	Max. Hp Rating				Catalog Number				
	3-Phase				Type 1				
	200V	230V	460V	575V	Non-reversing	Reversing	Non-reversing space saving	Reversing space saving	Contactor ¹
00	1 1/2	1 1/2	2	2	509-TAD-XXX	505-TAD-XXX	-	-	500-TAD930
0	3	3	5	5	509-AAD-XXX	-	309-AAD-XXX	305-AAD-XXX	500-AAD930
1	7 1/2	7 1/2	10	10	509-BAD-XXX	-	309-BAD-XXX	305-BAD-XXX	500-BAD930
2	10	15	25	25	509-CAD-XXX	-	309-CAD-XXX	-	500-CAD930

¹ All starters and contactors come standard with a 120V AC coil.

NEMA Sizes 0...3 by Components

Base Contactor with 120V Coil

Open Type Without Enclosure		
NEMA Size	Continuous Ampere Rating [A]	Cat. No.
0	18	500F-A0D930
1	27	500F-B0D930
2	45	500F-C0D930
3	90	500F-D0D930

Coils⁴

Description	NEMA Size		
	0...1	2	3
	Cat. No.	Cat. No.	Cat. No.
24V DC	599-B24DC	599-C24DC	599-D24DC
110V 50 Hz, 120V 60 Hz	599-CB236	599-CC236	599-CD236
220V 50 Hz, 240V 60 Hz	599-CB254	599-CC254	599-CD254
440V 50 Hz, 480V 60 Hz	599-CB273	599-CC273	599-CD273

⁴ For 309 replacement coils and overloads, visit <https://rok.auto/directory>.

Command and Indication Devices

Kit Description	Cat. No.
Push Button, Start-Stop	198-SSPB ²
Selector Switch, Plastic, HOA/FOR	198-3SS
Pilot Light, 24...120V AC/DC, Red LED	198-RUPL
Pilot Light, 24...120V AC/DC, Green LED	198-GUPL
208/120V AC transformer kit	1497-HD50 ³
240/120V AC transformer kit	1497-AD50 ³
480/120V AC transformer kit	1497-BD50 ³
600/120V AC transformer kit	1497-CD50 ³

² Can only be used with non-reversing starters and contactors.

³ Transformer kits are pre-engineered with fuses and fuse covers.

Solid-State Overload Relays⁵

NEMA Size	Current Range [A]	Cat. No.
0, 1	1.0...5.0	592-1EFCC
0...2	5.4...27	592-1EFEC
3	11...55	592-1EFFD
3	20...110	592-1EFGD

⁵ For Eutectic Alloy Overload Relays, please visit <https://rok.auto/directory>.

Drives



1-72...1-77

For more information on our complete family of IEC starter products, please visit:
<https://rok.auto/lv-starters>



Starters

POWER

Combination Starters, NEMA 312, 512 / 313, 513

- 312, 512 with fusible and non-fusible disconnect switches
313, 513 with circuit breakers
- Starter sizes 0...7
- Patented snap-together wiring¹
- Overload relays: eutectic or solid-state
- Reversing and non-reversing available
- NEMA Type 1, 4/12/3R, 4/4X, 3R/7-9
- UL listed and CSA certified



The robust NEMA combination starters, now with patented snap-together wiring, are versatile in designs and flexible in configurations, allowing various command and indication options, enclosure sizes and environmental type ratings.

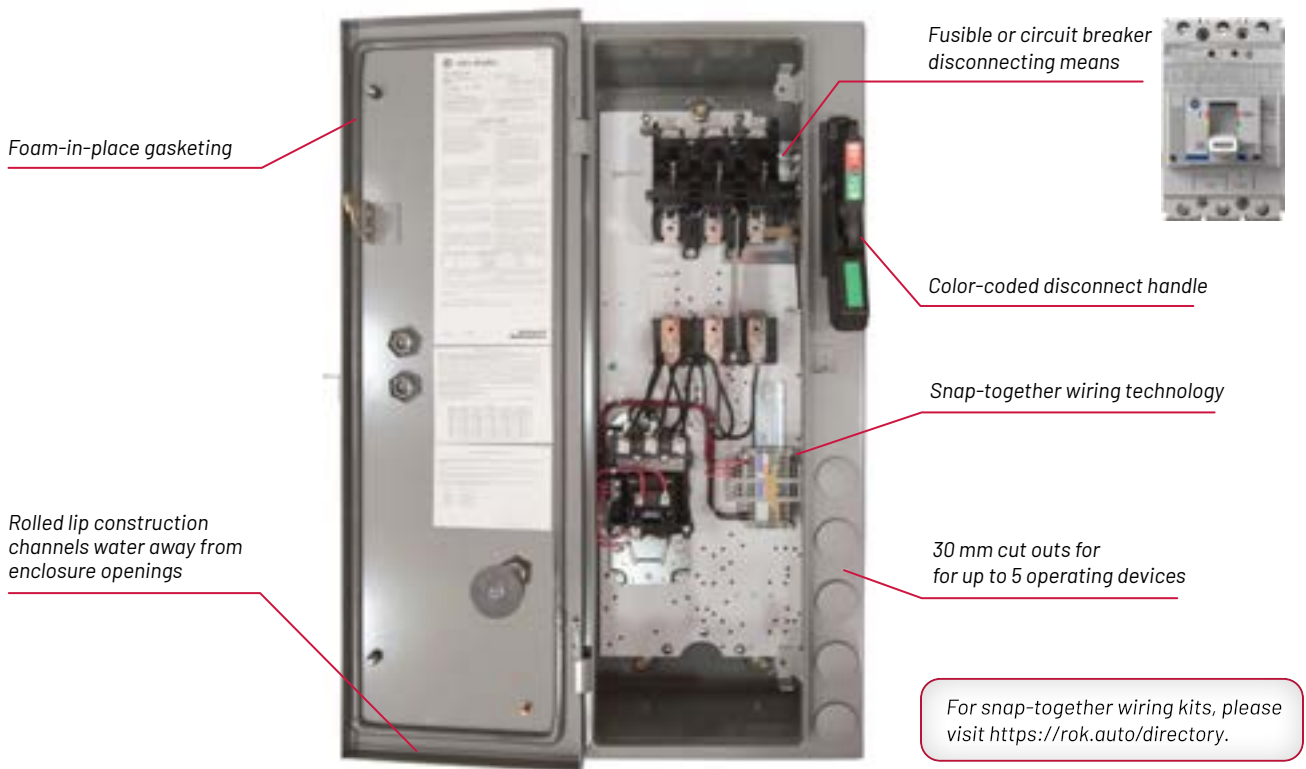

¹ Snap-together wiring is not available for NEMA size 6 reversing starters and higher, or for NEMA Type 7/9.

1-54

Circuit Breakers



1-2...1-15

Disconnect Switches



1-16...1-23

Control & Load Switches



1-24...1-27

Contactors



1-28...1-41

Starters



1-42...1-55

Motor Protection



1-56...1-61

Smart Motor Control



1-62...1-71

Product Selection

312, 512 NEMA Non-Reversing Combination Starters in Type 3R/4/12 Rainproof, Dustproof Enclosures

Size	Cont. Ampere Rating [A]	Max. Hp Rating ²		Fuse Clip Rating [A] ¹	312-*	512-*
		Motor Voltage, 60 Hz			Cat. No.	Cat. No.
		230V	460...575V			
1	27	7-1/2	10	30	312-BF⊗-R03	512-BF⊗-R24R
2	45	15	25	60	312-CF⊗-R06	512-CF⊗-R25R
3	90	30	50	100	312-DF⊗-R10	512-DF⊗-R26R
4	135	50	100	200	312-EF⊗-R20	512-EF⊗-R27R
		50	100	400	312-EF⊗-J40	512-EF⊗-R28J
5	270	75	200	400	312-FF⊗-R40	512-FF⊗-R28R
6	540	200	400	600 ³	312-GF⊗-R60	512-GF⊗-R29R

513 NEMA Non-Reversing Combination Starters

Size	Cont. Ampere Rating [A]	Max. Hp Rating ²			313-*	513-*
		Motor Voltage, 60 Hz			Cat. No.	Cat. No.
		230V	460V	575V		
1	27	1/2...1	0...1	0...1	313-BF⊗-C15	513-BF⊗-C35
		1-1/2...3	1-1/2...3	1-1/2...3	313-BF⊗-C15	513-BF⊗-C38
		5...7-1/2	5...7-1/2	5...7-1/2	313-BF⊗-C30	513-BF⊗-C40
2	45	10	-	-	313-CF⊗-C30	513-CF⊗-C41
		15	15	15	313-CF⊗-C30	513-CF⊗-C42
		-	20...25	20...25	313-CF⊗-C50	513-CF⊗-C44
3	90	30	-	30	313-DF⊗-C50	513-DF⊗-C45
		-	30...50	40...50	313-DF⊗-D10	513-DF⊗-C47
4	135	-	-	60	313-EF⊗-D10	513-EF⊗-C48
		-	60...75	-	313-EF⊗-D12	513-EF⊗-C49
		-	100	75...100	313-EF⊗-D15	513-EF⊗-C50
5	270	100	-	-	313-FF⊗-D30	513-FF⊗-C50
		-	-	125	313-FF⊗-D30	513-FF⊗-C51
		-	125...150	-	313-FF⊗-D40	513-FF⊗-C52
6	540	150	-	-	313-GF⊗-D60	513-GF⊗-C52T
		200	-	-	313-GF⊗-D60	513-GF⊗-C54T
		-	250	250	313-GF⊗-D60	513-GF⊗-C56T

⊗ The catalog number as listed is incomplete. Select coil voltage and overload relay codes from the tables. Use product configuration tool for additional options and accessories.

¹ Fuses not included. Select per NEC.

² Full load current must not exceed continuous ampere rating.

³ For 230V and 460V Hp ratings, limit the maximum fuse sizing to 125% of motor full load current.

⊗ AC Coil Voltage Codes

Common or Transformer Control	
Code	Line Voltage
H	208V, 60 Hz
A	240V, 60 Hz
B	480V, 60 Hz
C	600V, 60 Hz

120V Separate Control (No Transformer)

Code	Description
HD	208V / 120V, 60 Hz
AD	240V / 120V, 60 Hz
BD	480V / 120V, 60 Hz
CD	600V / 120V, 60 Hz

★ Overload Relay Code

NEMA Size	FLC Adjustment Range [A]	Overload Relay Code
0, 1	0.2...1.0	A2C
	1.0...5.0	A2E
	3.2...16	A2F
1	5.4...27	A2G
	9...45	A2J
2	5.4...27	A2G
	11...55	A2J
3	11...55	A2J
	20...100	A2L
4	30...150	A2M
5	60...300	A2N
6	120...600	A2R

Drives



1-72...1-77

For more information on our complete family of IEC starter products, please visit:
<https://rok.auto/lv-starters>



Motor Protection

POWER

Bimetallic Overload Relays 193-K/193-T1

- Most basic motor protection device
- Overload protection trip class 10
- Phase loss sensitivity
- Rated for DC and variable frequency drives applications up to 400 Hz
- 1 N.O. and 1 N.C. auxiliary contacts



Bimetallic Thermal Overload Relays are motor protectors for IEC applications.

- 193-K bimetallic overload relays are for use with 100-K and 104-K miniature reversing contactors.
- 193-T1 bimetallic overload relays are for use with 100-C and 104-C Contactors.

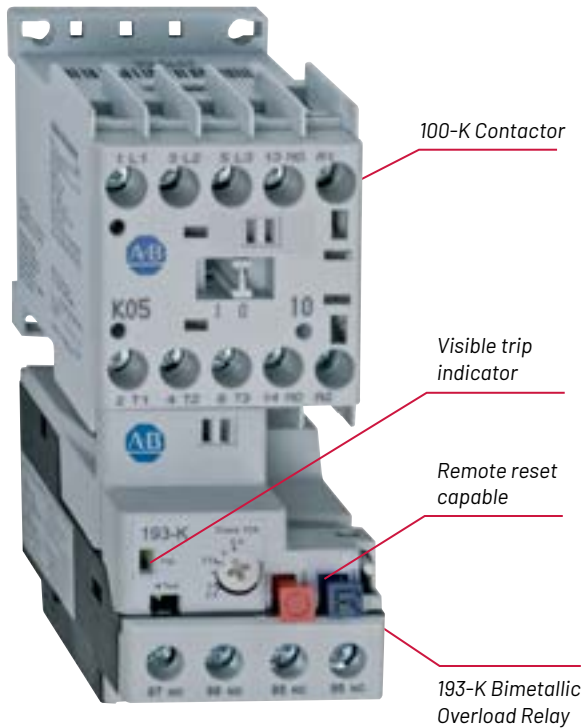

Applications

- Conveyors
- Fans
- Pumps
- VFD-controlled motors



Remote Reset Solenoid

For remote reset of 193-K and 193-T1 overload relays

1-56

Circuit Breakers



1-2...1-15

Disconnect Switches



1-16...1-23

Control & Load Switches



1-24...1-27

Contactors



1-28...1-41

Starters



1-42...1-55

Motor Protection



1-56...1-61

Smart Motor Control



1-62...1-71

Product Selection

Bimetallic Overload Relays

Mounts to Contactor	Adjustment Range [A]	Cat. No.
100-C09...100-C23	0.90...1.3	193-T1AB13
	1.8...2.5	193-T1AB25
	2.9...4.0	193-T1AB40
	4.5...6.3	193-T1AB60
	5.5...7.5	193-T1AB75
	7.2...10	193-T1AC10
	9.0...12.5	193-T1AC12
	11.3...16	193-T1AC16
100-C30...100-C37	21...25	193-T1AC25
	15...20	193-T1BC20
	21...25	193-T1BC25
	29...36	193-T1BC36
100-C43...100-C55	33...38	193-T1BC38
	17...25	193-T1CC25
	35...47	193-T1CC47
100-C60...100-C97	45...60	193-T1CC60
	35...47	193-T1DC47
	45...60	193-T1DC60 ¹
	58...75	193-T1DC75 ¹
	72...90	193-T1DC90 ¹
	77...97	193-T1DC97 ¹

¹ Panel mount version available.

Mounts to Contactor	Adjustment Range [A]	Cat. No.
100-K05...K12	0.16...0.25	193-KA25
	0.25...0.40	193-KA40
	0.35...0.50	193-KA50
	0.45...0.63	193-KA63
	0.55...0.80	193-KA80
	0.75...1.0	193-KB10
	0.9...1.3	193-KB13
	1.1...1.6	193-KB16
	1.4...2.0	193-KB20
	1.8...2.5	193-KB25
	2.3...3.2	193-KB32
	2.9...4.0	193-KB40
	3.5...4.8	193-KB48
	4.5...6.3	193-KB63
100-K09...K12	5.5...7.5	193-KB75
	7.2...10.0	193-KC10
100-K12	9.0...12.5	193-KC12



Product Selection Tools

Available online or for download, our tools help you access info while in the office or on the go.

<https://rok.auto/selection>

Accessories

Description		For Use With	Cat. No.
DIN Rail/Panel Mounting Adapter	For separate mounting of overload relays. Snaps on to 35 mm top hat rail	193-T1AA, 193-T1AB, 193-T1AC, 193-T1BC	193-T1APM
Screw Adapter	For screw fixing of the 193-T1APM panel adapter. (2 required per adapter)	193-T1APM	140M-C-N45
Remote Reset Solenoid	24V AC, 50/60 Hz	193-K, 193-T1	193-T1RKJ
	110/120V AC, 50/60 Hz		193-T1RD
	220/240V AC, 50/60 Hz		193-T1RKF
	24V DC		193-T1RZJ
	48V DC		193-T1RZY
	115V DC		193-T1RZD

Drives



1-72...1-77

For more information on our complete family of circuit protection products, please visit:
<https://rok.auto/circuit-load-protection>



Motor Protection

POWER

Electronic Overload Relays E100

- Adjustable trip class, 10 or 20
- 5:1 wide current adjustment range to cover a variety of motor applications
- 48% footprint reduction using pass-thru solution
- Pass-thru minimizes number of power terminal connections
- Accurate and repeatable settings to help minimize commissioning time
- Built-in thermal memory and phase loss detection helps protect your motor investment



The E100 Electronic Overload Relay is the next generation basic-tier electronic overload relay. It has enhanced features to better safeguard your motor protection investments, including increased accuracy and repeatability, a self-powered design with lower heat dissipation, and an aggressive component certification strategy.

Optional Accessories

- Ground fault/jam
- Remote reset and/or indication
- Anti-tamper shields
- DIN rail/panel mounting
- External CT configurations

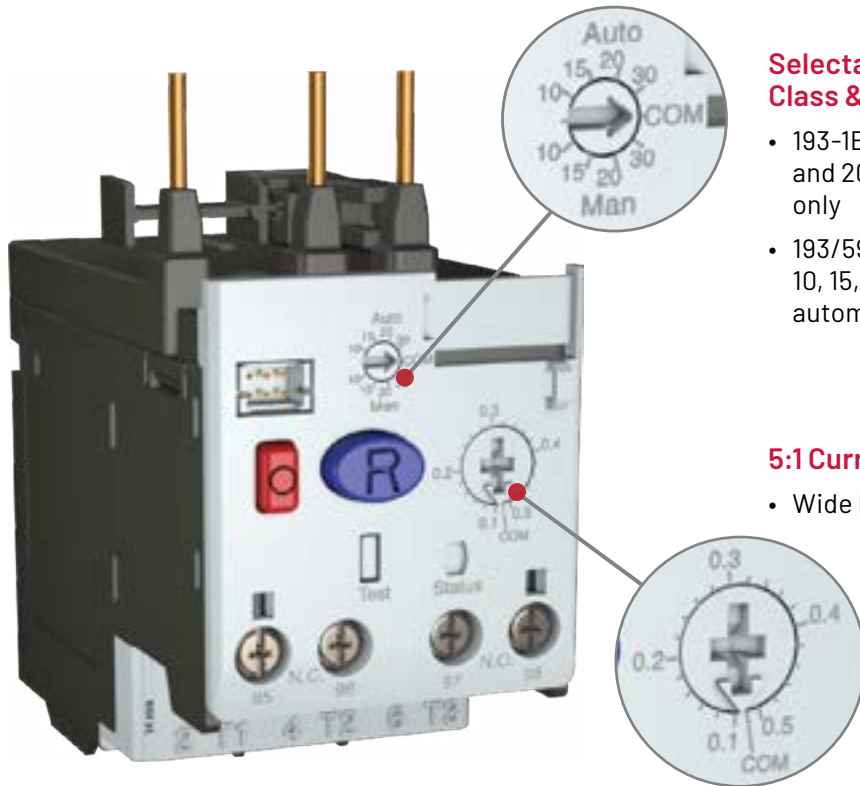

E100-EF shown

Selectable Trip Class & Reset Mode

- 193-1EE: Trip Class 10 and 20, manual reset only
- 193/592-1EF: Trip Class 10, 15, 20, 30, manual or automatic reset

5:1 Current Range

- Wide FLA range

1-58

Circuit Breakers



1-2...1-15

Disconnect Switches



1-16...1-23

Control & Load Switches



1-24...1-27

Contactors



1-28...1-41

Starters



1-42...1-55

Motor Protection



1-56...1-61

Smart Motor Control



1-62...1-71

Product Selection

Current Range [A]	Mounting Style	Cat. No.
0.1 - 0.5	IEC Direct Mount (100-C09...C23)	193-1EEAB
0.2 - 1	IEC Direct Mount (100-C09...C23)	193-1EEBB
1 - 5	IEC Direct Mount (100-C09...C23)	193-1EECB
3.2 - 16	IEC Direct Mount (100-C09...C23)	193-1EEDB
5.4 - 27	IEC Direct Mount (100-C09...C23)	193-1EEEB
5.4 - 27	IEC Direct Mount (100-C30...C55)	193-1EEED
11 - 55	IEC Direct Mount (100-C30...C55)	193-1EEFD
20 - 100	IEC Direct Mount (100-C60...C97)	193-1EEGE
0.1 - 0.5	IEC Direct Mount (100-C09...C23)	193-1EFAB
0.2 - 1	IEC Direct Mount (100-C09...C23)	193-1EFBB
1 - 5	IEC Direct Mount (100-C09...C23)	193-1EFGB
3.2 - 16	IEC Direct Mount (100-C09...C23)	193-1EFDB
5.4 - 27	IEC Direct Mount (100-C09...C23)	193-1EFEB
5.4 - 27	IEC Direct Mount (100-C30...C55)	193-1EFED
11 - 55	IEC Direct Mount (100-C30...C55)	193-1EFFD
20 - 100	IEC Direct Mount (100-60...C97)	193-1EFGE
0.1 - 0.5	NEMA Direct Mount (Size 00)	592-1EFAT
0.2 - 1.0	NEMA Direct Mount (Size 00)	592-1EFBT
1.0 - 5.0	NEMA Direct Mount (Size 00)	592-1EFCT
3.2 - 16	NEMA Direct Mount (Size 00)	592-1EFDT
0.2 - 1.0	NEMA Direct Mount (Size 0...2)	592-1EFBC
1.0 - 5.0	NEMA Direct Mount (Size 0...2)	592-1EFCC
3.2 - 16	NEMA Direct Mount (Size 0...2)	592-1EFDC
5.4 - 27	NEMA Direct Mount (Size 0...2)	592-1EFEC
11 - 55	NEMA Direct Mount (Size 0...2)	592-1EFFC
20 - 100	NEMA Direct Mount (Size 3)	592-1EFGD
30 - 150	External CT Configurations	193-1EFHZ
40 - 200	External CT Configurations	193-1EFJZ
60 - 300	External CT Configurations	193-1EFKZ
100 - 500	External CT Configurations	193-1EFLZ
120 - 600	External CT Configurations	193-1EFMZ
160 - 800	External CT Configurations	193-1EFNZ
80 - 400	External CT Configurations	193-1EFWZ
1 - 5	Pass - Thru	193-1EECP
3.2 - 16	Pass - Thru	193-1EEDP
5.4 - 27	Pass - Thru	193-1EEEP
11 - 55	Pass - Thru	193-1EEFP
20 - 100	Pass - Thru	193-1EEGP
1 - 5	Pass - Thru	193-1EFCP
3.2 - 16	Pass - Thru	193-1EFDP
5.4 - 27	Pass - Thru	193-1EFEP
11 - 55	Pass - Thru	193-1EFFP
20 - 100	Pass - Thru	193-1EFGP

Accessories

Accessory	Cat. No.
Base Unit Anti-Tamper Shield	193-1BC8
Universal Protection Module	193-1EGJ
Protection Accessory Anti-Tamper Shield	193-1EMC
240V AC Remote Reset Solenoid	193-1EMRA
120V AC Remote Reset Solenoid	193-1EMRD
24V DC Remote Reset Solenoid	193-1EMRZ
DIN Rail/Panel Adapter Frame B	193-1EPB
DIN Rail/Panel Adapter Frame D	193-1EPD
DIN Rail/Panel Adapter Frame E	193-1EPE
External Reset Adapter	193-1ERA
ERID Adapter	193-1ERR
Remote indication Display with Reset	193-ERID
Remote Indication Display - No Reset	193-1ERIDN
Accessory Panel/DIN Mounting Kit	193-1EIKIT1
Accessory Install Kit & Spare TBs	193-1EIKIT2

Drives



1-72...1-77

For more information on our complete family of circuit protection products, please visit:
<https://rok.auto/circuit-load-protection>



Motor Protection

POWER

Electronic Overload Relays E300/E200

- Modular design for application customization
- Sensing, control, and communication modules
- Diagnostic information to monitor motor performance
- Logix integration with add-on profiles, add-on instructions, and Pre-configured Operator Faceplate Objects
- Dual-port EtherNet/IP, DeviceNet, and non-networked communication options
- Simplified wiring between E300™/E200™ Electronic Overload Relay and 100-C contactor



The E300/E200 Electronic Overload Relays provide a flexible design and advanced intelligence. With real-time motor diagnostic information to proactively indicate when a motor is having a problem allowing you to efficiently troubleshoot.

Mounting Options

Multiple mounting options allow you to install the E300/E200 Electronic Overload Relays into your existing system.



Modular Design

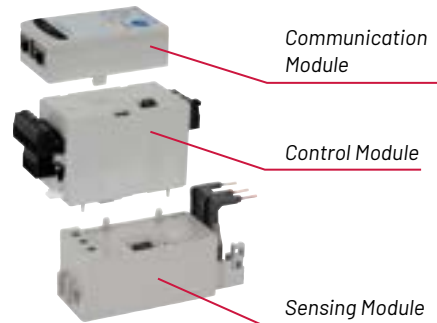

DeviceLogix

- Faster local I/O processing
- Helps improve control system performance
- Increase system reliability
- Increase system/machine modularity

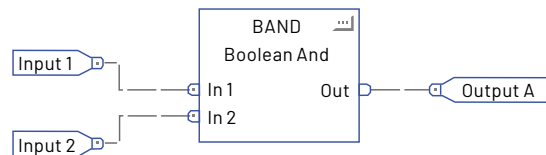

Circuit Breakers



1-2...1-15

Disconnect Switches



1-16...1-23

Control & Load Switches



1-24...1-27

Contactors



1-28...1-41

Starters



1-42...1-55

Motor Protection



1-56...1-61

Smart Motor Control



1-62...1-71

Product Selection

Sensing Modules

Mounting Options	Current Range [A]	For Use With	Cat. No.
IEC Contactors	0.5...30	100-C09...C23	193-ESM-⊗-30A-C23
		100-C30...C55	193-ESM-⊗-30A-C55
	6...60	100-C30...C55	193-ESM-⊗-60A-C55
	10...100	100-C60...100-C97	193-ESM-⊗-100A-C97
	20...200	100-E116...100-E146	193-ESM-⊗-200A-E146
		100-E190...100-E205	193-ESM-⊗-200A-E205
DIN Rail / Panel Mount Power Terminals	0.5...30	All contactors and external current transformers	193-ESM-⊗-30A-T
	6...60	All contactors	193-ESM-⊗-60A-T
	10...100		193-ESM-⊗-100A-T
DIN Rail / Panel Mount Power Terminals. Directly replaces 193-ECPM_	0.5...30	All contactors and external current transformers	193-ESM-⊗-30A-E3T
	6...60	All contactors	193-ESM-⊗-60A-E3T
	10...100		193-ESM-⊗-100A-E3T
DIN Rail / Panel Mount Pass-thru	0.5...30	All contactors and external current transformers	193-ESM-⊗-30A-P
	6...60	All contactors	193-ESM-⊗-60A-P
	10...100		193-ESM-⊗-100A-P
NEMA Contactors	0.5...30	NEMA Size 0...2	592-ESM-⊗-30A-S2
	6...60		592-ESM-⊗-60A-S2
	10...100	NEMA Size 3	592-ESM-⊗-100A-S3

⊗ The catalog number as listed is incomplete. Use an **I** (Current), **IG** (Current/Ground Fault) or **VIG** (Voltage/Current/Ground Fault) to complete the catalog number.

Control Modules

Description	No. of Inputs/Outputs	Rated Control Voltage [V]	Cat. No.
I/O Module	6 in/3 out	24V DC	193-EIO-63-24D
	2 in/2 out		193-EIO-22-24D
	4 in/3 out	110...120V AC, 50/60 Hz	193-EIO-43-120
	2 in/2 out		193-EIO-22-120
	4 in/3 out	220...240V AC, 50/60 Hz	193-EIO-43-240
	2 in/2 out		193-EIO-22-240
I/O and Protection Module. Thermistor (PTC) and External Ground Fault Current ¹	4 in/2 out	24V DC	193-EIOGP-42-24D
	2 in/2 out	110...120V AC, 50/60 Hz	193-EIOGP-22-120
	2 in/2 out	220...240V AC, 50/60 Hz	193-EIOGP-22-240

¹ Requires core balanced ground fault sensor, refer to chart on 1-57.

Communication Modules

Description	Cat. No.
EtherNet/IP	193-ECM-ETR
DeviceNet	193-ECM-DNT
Parameter Configuration Module (E200)	193-ECM-PCM

Expansion Modules

Description	No. of Inputs/Outputs	Rated Control Voltage [V]	Cat. No.
Digital Expansion Module, 24V DC	4 in/2 out	24V DC	193-EXP-DIO-42-24D
Digital Expansion Module, 120V AC	4 in/2 out	110...120V AC, 50/60 Hz	193-EXP-DIO-42-120
Digital Expansion Module, 240V AC	4 in/2 out	220...240V AC, 50/60 Hz	193-EXP-DIO-42-240
Analog Expansion Module: mA, V, RTD, and Resistance	3 universal in/1 out	-	193-EXP-AIO-31 ²
Expansion Power Supply	-	24V DC	193-EXP-PS-DC
		110...240V AC, 50/60 Hz	193-EXP-PS-AC
Starter Control Station with 3-Meter Cable	-	-	193-EOS-SCS
Starter Diagnostic Station with 3-Meter Cable	-	-	193-EOS-SDS ²

² Module requires control module firmware v3.xxx or higher for Series A. No firmware version restrictions for Series B control modules.

Drives



For more information on our complete family of circuit protection products, please visit:
<https://rok.auto/circuit-load-protection>



Smart Motor Control

POWER

Solid-State Contactors 156-C

- Ideal for high duty cycle applications
- Operational current rating 20...85 A
- 1, 2, or 3-phase capable
- AC and DC control options
- Zero cross switching to help reduce EMC emissions



The next generation 156-C solid-state contactors from Allen-Bradley are flexible in configuration and design, these devices can be panel or DIN Rail mounted complete with the integrated heatsink and do not require additional components or assembly. Microprocessor and PLC compatible, the solid-state contactors can be used in applications that range from heaters to small motors and valves.

Panel or DIN Rail mounting
for flexible installation

Compact modular design
with heatsink

Optimized to help reduce electrical costs and needs

- Low electrical and acoustical noise
- Low input power
- Operational current up to 85 A (AC-1), 65 A (AC-3)
- Line voltage ratings up to 600V
- UL/cUL as a motor controller
- IEC AC51/AC53 resistive/inductive rated



LED Status Indicators

2 or 3 phase capable in 3 pole configuration
(1 pole option available)

Circuit Breakers



1-2...1-15

Disconnect Switches



1-16...1-23

Control & Load Switches



1-24...1-27

Contactors



1-28...1-41

Starters



1-42...1-55

Motor Protection



1-56...1-61

Smart
Motor Control



1-62...1-71

Product Selection

Single-Phase Power Contactors

Current Rating [A]	Control Voltage	Rated Power @ 40 °C (104 °F)						Operational voltage < 240 V AC	Operational Voltage < 600 V AC
			115V	230V	400V	480V	600V		
20	20 - 275 V AC 24 - 190 V DC	Hp	1/3	1	2	3	3	156-C1P20NAB	156-C1P20NCB
	5 to 32 volts DC	kW	0.18	0.37	0.75	1.1	1.5	156-C1P20NAD	156-C1P20NCD
25	20 - 275 V AC 24 - 190 V DC	Hp	1/3	1	2	3	3	156-C1P25NAB	156-C1P25NCB
	5 to 32 volts DC	kW	0.18	0.37	0.75	1.1	1.5	156-C1P25NAD	156-C1P25NCD
43	20 - 275 V AC 24 - 190 V DC	Hp	1-1/2	3	5	7-1/2	10	-	156-C1P43NCB
	5 to 32 volts DC	kW	0.6	1.5	2.2	3.7	4.0	-	156-C1P43NCD
65	20 - 275 V AC 24 - 190 V DC	Hp	2	5	7-1/2	10	15	-	156-C1P65NCB
	5 to 32 volts DC	kW	0.75	1.5	4.0	4.0	5.5	-	156-C1P65NCD
85	20 - 275 V AC 24 - 190 V DC	Hp	2	5	7-1/2	10	15	-	156-C1P85NCB
	5 to 32 volts DC	kW	0.75	1.5	4.0	4.0	5.5	-	156-C1P85NCD

Dual-Phase Power Contactors

Current Rating [A]	Control Voltage	Rated Power @ 40 °C (104 °F)						Operational voltage < 240 V AC	Operational Voltage < 600 V AC
			115V	230V	400V	480V	600V		
25	20 - 275 V AC 24 - 190 V DC	Hp	1-1/2	3	5	7-1/2	10	-	156-C2P25NCB
	5 to 32 volts DC	kW	1.1	3.0	5.5	5.5	9.0	-	156-C2P25NCD
40	20 - 275 V AC 24 - 190 V DC	Hp	3	5	10	10	15	-	156-C2P40NCB
	5 to 32 volts DC	kW	1.5	4.0	7.5	9.0	11.0	-	156-C2P40NCD
75	20 - 275 V AC 24 - 190 V DC	Hp	5	10	15	20	25	-	156-C2P75NCBA
	5 to 32 volts DC	kW	3.0	7.5	11.0	15.0	22.0	-	156-C2P75NCDA

Three-Phase Power Contactors

Current Rating [A]	Control Voltage	Rated Power @ 40 °C (104 °F)						Operational voltage < 240 V AC	Operational Voltage < 600 V AC
			115V	230V	400V	480V	600V		
20	20 - 275 V AC 24 - 190 V DC	Hp	1	3	5	7-1/2	10	156-C3P20NAB	156-C3P20NCB
	5 to 32 volts DC	kW	0.8	2.2	4.0	5.5	7.5	156-C3P20NAD	156-C3P20NCD
25	20 - 275 V AC 24 - 190 V DC	Hp	2	3	7-1/2	10	10	-	156-C3P25NCB
	5 to 32 volts DC	kW	1.1	2.2	4.0	5.5	7.5	-	156-C3P25NCD
30	20 - 275 V AC 24 - 190 V DC	Hp	2	5	10	10	15	-	156-C3P30NCB
	5 to 32 volts DC	kW	1.5	3.0	5.5	7.5	11.0	-	156-C3P30NCD
40	20 - 275 V AC 24 - 190 V DC	Hp	2	5	10	10	15	-	156-C3P40NCBA
	5 to 32 volts DC	kW	1.4	4.0	7.5	9.0	11.0	-	156-C3P40NCDD
65	20 - 275 V AC 24 - 190 V DC	Hp	3	10	15	20	25	-	156-C3P65NCBA
	5 to 32 volts DC	kW	3.0	5.5	11.0	15.0	20.0	-	156-C3P65NCDA

Drives



1-72...1-77

For more information on our complete family of circuit protection products, please visit:
<https://rok.auto/motor-control-contactors>



Smart Motor Control

POWER

Starting Torque Controllers 154

- Ideal for reducing electrical and mechanical system shock
- Operational current rating 12...25 A
- 1 or 3-phase capable with 1 or 2 controlling phases
- AC and DC control options
- Adjustable torque setting and ramp time duration



The Allen-Bradley® Starting Torque Controller (STC) is designed for low horsepower single and three-phase squirrel cage induction motors. It is designed to help reduce system shock (electrical and mechanical) typically seen when directly starting on line voltage. This provides a smoother start and helps decrease downtime due to shock and vibration related problems. Typical applications include fans, material handling, pumps, palletizers, car washes and reduced voltage start single-phase applications.

Compact modular design with heat sink

Panel or DIN Rail mounting for flexible installation

Optimized to help reduce downtime due to shock and vibration problems

- 10%...80% initial torque value
- 0.5...5 secs ramp time
- Operational current up to 25A
- Line voltage ratings up to 600V
- UL/cUL as a motor controller
- IEC AC53 inductive ratings

Initial torque adjustment dial

Duration ramp adjustment dial

LED status indicators

1 or 3-phase capable



1-64

Circuit Breakers



1-2...1-15

Disconnect Switches



1-16...1-23

Control & Load Switches



1-24...1-27

Contactors



1-28...1-41

Starters



1-42...1-55

Motor Protection



1-56...1-61

Smart Motor Control



1-62...1-71

Product Selection

Single-Phase with Single Control Phase Starting Torque Controllers

Current Rating [A]	Rated Power @ 40 °C (104 °F)			Control Voltage	
		115V	230V	24V AC/DC	100...240VAC
12	Hp	0.5	2	154-SP1C12NAR	154-SP1C12NAD
	kW	0.55	1.1		
16	Hp	0.5	2	154-SP1C16NAR	154-SP1C16NAD
	kW	0.75	1.5		
25	Hp	1	3	154-SP1C25NAR	154-SP1C25NAD
	kW	1.5	3		

Three-Phase with Single Control Phase Starting Torque Controllers

Current Rating [A]	Rated Power @ 40 °C (104 °F)					Control Voltage	
		220V	400V	460V	575V	24V AC/DC	100...240VAC
12	Hp	3	5	7.5	10	154-TP1C12NCR	154-TP1C12NCD
	kW	3	5.5	6.3	6.3		
16	Hp	5	7.5	10	10	154-TP1C16NCR	154-TP1C16NCD
	kW	4	7.5	7.5	7.5		
25	Hp	7.5	10	15	20	154-TP1C25NCR	154-TP1C25NCD
	kW	6.3	11	13	15		

Three-Phase with Two Control Phases Starting Torque Controllers

Current Rating [A]	Rated Power @ 40 °C (104 °F)					Control Voltage	
		220V	400V	460V	575V	24V AC/DC	100...240VAC
12	Hp	3	5	7.5	10	154-TP2C12NCR	154-TP2C12NCD
	kW	3	5.5	6.3	6.3		
16	Hp	5	7.5	10	10	154-TP2C16NCR	154-TP2C16NCD
	kW	4	7.5	7.5	7.5		
25	Hp	7.5	10	15	20	154-TP2C25NCR	154-TP2C25NCD
	kW	6.3	11	13	15		

Drives



1-72...1-77

For more information on our complete family of circuit protection products, please visit:
<https://rok.auto/motor-control-contactors>



Smart Motor Control

POWER

Smart Motor Controller 150 SMC™-3

- Solid-state soft-start motor controller with internal bypass
- Current ratings of 1...480 A
- Compact footprint
- Five Start/Stop modes
- Built-in machine overload protection
- 3-phase monitoring



Internal Bypass
The bypass automatically closes when the motor reaches its nominal speed, minimizing heat generation.

- Reduced enclosure size
- Reduced total cost

Easy and Secure Setup
DIP switches allow setting of the START/STOP profile, built-in overload, connection type, trip class, and auxiliary contact characteristics.

- Process optimization
- Setup efficiency

Hold to Test/ Push to Reset Button
Used to simulate fault conditions or reset the unit.

- Reduces downtime
- Assists during setup

Ultra-Compact Size
1...37 A units are only 45 mm wide.

- Reduced panel space
- Higher-density installations

Simplified Motor FLA Setup
Rotary switch allows quick and easy setup of motor FLA.

- Setup efficiency
- Protects motor assets

LED Display
Status information provided including RUN, Fault type and OFF.

- Instant status display
- Assists during troubleshooting

45 mm

Circuit Breakers



1-2...1-15

Disconnect Switches



1-16...1-23

Control & Load Switches



1-24...1-27

Contactors



1-28...1-41

Starters



1-42...1-55

Motor Protection



1-56...1-61

Smart Motor Control



1-62...1-71

Product Selection

Line-Connected Controllers

Rated Voltage [V AC]	Current Rating [A]	Starting Duty		Open Type		IP65 (Type 4/12) Enclosed Non-Combination Controllers Cat. No. ¹
		kW	Hp, 60 Hz	100...240V AC 50/60 Hz Control	24V AC/DC Control	
		350%	350%	Cat. No.	Cat. No.	
380/400/ 415/460	1...3	1.1	0.5...1.5	150-C3NBD	150-C3NBR	150-C3FBD
	3...9	4	1.5...5	150-C9NBD	150-C9NBR	150-C9FBD
	5.3...16	7.5	5...10	150-C16NBD	150-C16NBR	150-C16FBD
	6.3...19	7.5	5...10	150-C19NBD	150-C19NBR	150-C19FBD
	9.2...25	11	7.5...15	150-C25NBD	150-C25NBR	150-C25FBD
	10...30	15	7.5...20	150-C30NBD	150-C30NBR	150-C30FBD
	12.3...37	18.5	10...25	150-C37NBD	150-C37NBR	150-C37NBD
	14.3...43	22	10...30	150-C43NBD	150-C43NBR	150-C43FBD
	20...60	30	15...40	150-C60NBD	150-C60NBR	150-C60FBD
	28.3...85	45	25...60	150-C85NBD	150-C85NBR	150-C85FBD
	27...108	55	50...75	150-C108NBD	150-C108NBR ¹	150-C108FBD
	34...135	75	60...100	150-C135NBD	150-C135NBR ¹	150-C135FBD
	67...201	95...110	75...150	150-C201NBD	150-C201NBR ¹	150-C201FBD
	84...251	95...132	100...200	150-C251NBD	150-C251NBR ¹	150-C251FBD
	106...317	95...160	125...250	150-C317NBD	150-C317NBR ¹	150-C317FBD
	120...361	110...200	250...300	150-C361NBD	150-C361NBR ¹	150-C361FBD
160...480	160...250	300...400	150-C480NBD	150-C480NBR ¹	150-C480FBD	

¹ Separate 120V or 240V single phase is required for fan operation.

Accessories

Protective Modules

Description	For Use With	Cat. No.
480V Protective Module	150-C3...37NB	150-C84
	150-C43...85NB (line and/or load)	150-C84P
	150-C108...480NB (line and/or load)	150-F84L

Replacement Fan

Description	For Use With	Cat. No.
Field installable	150-C3...37	150-CF64
	150-C43...85	150-CF147
replacement fan	150-C108, 150-C135	41391-801-03
	150-C201, 150-C251	41391-801-01
	150-C317...C480	41391-801-02

Terminal Lug Kits (108...480 A)

Current Rating [A] ²	Wire Size	Total No. of Line Controller Terminal Lugs		Pkg. Qty.	Cat. No.	Terminal Covers Cat. No.
		Per Line Side	Per Load Side			
108...135 ³	#6...250 MCM AWG	3	3	3	199-LF1	150-TC1
201...251 ³	16...120 mm ²	6	6			150-TC2
317...480 ³	#4...500 MCM AWG 25...240 mm ²	6	6		199-LG1	150-TC3

² 5...85 A units have box lugs standard. No additional lugs are required.

³ When a multi-conductor lug is required, refer to the Instruction Sheet for appropriate lug catalog number.

Auxiliary Contact Blocks

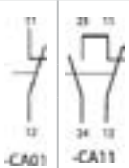
Description	N.O.	N.C.	Connection Diagram	Cat. No.
Side mount with sequence terminal designations • 1- and 2-pole • Quick and easy mounting without tools • One block per device only	1	0		150-CA10
	2	0		150-CA20
	0	1		150-CA01
	1	1		150-CA11 (Form C)

Drives



1-72...1-77

For more information on our complete family of soft starter products, please visit:
<https://rok.auto/lv-soft-starters>



Smart Motor Control

POWER

Smart Motor Controller 150 SMC™ Flex

- Solid-state soft-start motor controller with internal bypass
- Current ratings of 1...1250 A
- Modular for installation and maintenance
- Built-in LCD and keypad
- Nine Start/Stop modes & up to three slow-speed modes
- Full metering and diagnostics



Integral Bypass

The bypass automatically closes when the motor reaches its nominal speed, minimizing heat generation.

- Reduced enclosure size
- Reduced total cost

Feed-through Wiring

Power Pole

Communications

Optional communication modules allow the SMC-Flex to be connected to multiple networks.

- Common DPI modules reduce inventory
 - EtherNet/IP, DeviceNet, ControlNet and other networks available

Advanced Monitoring and Diagnostics

Built-in current and voltage protection provide enhanced power monitoring and diagnostic capabilities.

- No additional monitoring equipment required
- PTC input
- Ground fault detection

Simplified Application Setup

Built-in multilingual, backlit LCD display for programming and monitoring.

- Setup efficiency
- Process optimization



Circuit Breakers



1-2...1-15

Disconnect Switches



1-16...1-23

Control & Load Switches



1-24...1-27

Contactors



1-28...1-41

Starters



1-42...1-55

Motor Protection



1-56...1-61

Smart Motor Control



1-62...1-71

Product Selection

Line-Connected Controllers

Rated Voltage [V AC]	Motor Current [A]	kW	Hp, 60 Hz	Open Type		IP65 (Type 4/12) Enclosed Non-Combination Controllers ^{3,4}
				100...240V AC 50/60 Hz Control ¹	24V AC/DC Control ²	
				Cat. No.	Cat. No.	
400/415/460	1...5	2.2	3	150-F5NBD	150-F5NBR	150-F5FBD
	5...25	11	15	150-F25NBD	150-F25NBR	150-F25FBD
	8.6...43	22	30	150-F43NBD	150-F43NBR	150-F43FBD
	12...60	30	40	150-F60NBD	150-F60NBR	150-F60FBD
	17...85	45	60	150-F85NBD	150-F85NBR	150-F85FBD
	27...108	55	75	150-F108NBD	150-F108NBR	150F-D10JCD
	34...135	75	100	150-F135NBD	150-F135NBR	150F-D13JCD
	67...201	110	150	150-F201NBD	150-F201NBR	150F-D20JCD
	84...251	132	200	150-F251NBD	150-F251NBR	150F-D25JCD
	106...317	160	250	150-F317NBD	150-F317NBR	150F-D31JCD
	120...361	200	300	150-F361NBD	150-F361NBR	150F-D36JCD
	160...480	250	400	150-F480NBD	150-F480NBR	150F-D48JCD
	208...625	355	500	150-F625NBE	-	150F-D62JCD
	260...780	450	600	150-F780NBE	-	150F-D78JCD
323...970	560	800	150-F970NBE	-	-	
416...1250	710	1000	150-F1250NBE	-	-	

¹ 625...1250 A devices listed are only available for 110/120V control. For 230/240V control, change the **E** in the catalog number to an **A**.
Example: Catalog number 150-F625NBE becomes 150-F625NBA.

² Separate 120V or 240V single-phase power supply is required for fan operation.

³ Line and load termination are provided as standard.

⁴ These controllers require a separate 100...240V, 50/60 Hz single-phase control source. To add a control circuit transformer to the enclosure, add the appropriate option code to the catalog number.

Accessories

Terminal Lug Kits (108...1250 A)

Current Rating [A] ⁵	Wire Size	Total No. of Line Controller Terminal Lugs		Cat. No.	Terminal Covers
		Per Line Side	Per Load Side		Cat. No.
108...135 ⁶	#6...250 MCM AWG	3	3	199-LF1	150-TC1
201...251 ⁶	16...120 mm ²	6	6		150-TC2
317...480 ⁶	#4...500 MCM AWG 25...240 mm ²	6	6	199-LG1	150-TC3
625...780	2/0...500 MCM AWG	6	6	100-DL630	
970	4/0...500 MCM AWG	3	3	100-DL860	
1250 ⁷	2/0...500 MCM AWG	3	3	100-DL630	
	4/0...500 MCM AWG	3	3	100-DL860	

⁵ 5...85 A units have box lugs standard. No additional lugs are required.

⁶ When a multi-conductor lug is required, see the SMC-Flex user manual for recommended lugs.

⁷ The 1250 A device requires (1) catalog number 100-DL630 and (1) catalog number 100-DL860 per connection.

Protective Modules

Current Rating [A]	Description	Cat. No.
5...85	480V Protective Module	150-F84
108...1250		150-F84L
5...85	600V Protective Module	150-F86
108...1250		150-F86L
5...480 ⁸	Core Balance Current Transformer	825-CBCT

⁸ For the 625...1250 A devices, please see user manual.

Communication Modules

Network	Cat. No.
EtherNet/IP	20-COMM-E
Dual-port EtherNet/IP	20-COMM-ER
DeviceNet	20-COMM-D
ControlNet (Coax)	20-COMM-C
PROFIBUS DP	20-COMM-P

Drives



1-72...1-77

For more information on our complete family of soft starter products, please visit:
<https://rok.auto/lv-soft-starters>



Smart Motor Control

POWER

Smart Motor Controller 150 SMC™-50

- Internal Bypass Power Structure
 - Ideal for standard applications
 - Current ratings of 108...480 A
- Solid-State Power Structure
 - Ideal for harsh environments
 - Ideal for more aggressive duty-cycle applications
 - Current ratings of 90...520 A
 - Normal and heavy-duty ratings
- 17 Start/stop modes and 3 slow-speed modes
- DeviceLogix programming for embedded user logic



The scalable design of the SMC-50 satisfies a wide variety of control needs. Advanced monitoring, superior communications capabilities and Energy Saver mode help increase efficiency and reduce downtime. The Internal Bypass power structure automatically closes when the motor reaches its nominal speed, minimizing heat generation. It offers reduced enclosure size and cost. The Solid-State power structure offers higher operations per hour, scalable thermal ratings and higher SCCR ratings.

		SMC 50 with Internal Bypass	150 SMC 50 Solid-State
Simplified, Scalable Application Setup	Optional parameter configuration module, human interface module, or PC-based software for programming and monitoring simplifies setup.	• Setup efficiency • Process optimization	✓
Hardware Expansion Ports	Three hardware expansion ports accept optional digital and analog I/O expansion modules as well as a protection module (PTC, Ground Fault, Current Feedback).	• Process scalability and optimization • Application flexibility (simple to complex)	✓
Common Control Module	All features/functions are included in standard control module including linear acceleration/deceleration, torque control, pump control, Smart Motor Braking (SMB), and Energy Saver mode.	• Reduced inventory • Increased efficiency	✓
Hold to Test/Push to Reset Button	Used to quickly test for fault conditions or reset the unit.	• Reduces downtime • Assist during setup	✓
LED Display	Multi-colored LED provides both diagnostics and controller status information.	• Instant status display • Assists during troubleshooting	✓
Communications	Optional communication modules allow the SMC-50 to be connected to multiple networks.	• Common DPI modules reduce inventory • EtherNet/IP, DeviceNet, ControlNet and other networks available	✓

SMC-50 Virtual Demonstration

For more information please visit: <https://rok.auto/SMC50>

Circuit Breakers



1-2...1-15

Disconnect Switches



1-16...1-23

Control & Load Switches



1-24...1-27

Contactors



1-28...1-41

Starters



1-42...1-55

Motor Protection



1-56...1-61

Smart Motor Control



1-62...1-71

Product Selection

Line-Connected Controllers

Rated Voltage [V AC]	Motor Current [A]	kW	Hp, 60 Hz	Open Type		IP65 (Type 4/12) Enclosed Non-Combination Controllers Cat. No. ^{1,2}
				100...240V AC, 50/60 Hz	24V DC	
				Cat. No.	Cat. No.	
Internal Bypass						
400/415 (kW) 460 (Hp)	27...108	55	75	150-S108NBD	150-S108NBR	150S-D10JDC
	34...135	75	100	150-S135NBD	150-S135NBR	150S-D13JDC
	67...201	110	150	150-S201NBD	150-S201NBR	150S-D20JDC
	84...251	132	200	150-S251NBD	150-S251NBR	150S-D25JDC
	106...317	160	250	150-S317NBD	150-S317NBR	150S-D31JDC
	120...361	200	300	150-S361NBD	150-S361NBR	150S-D36JDC
	160...480	250	400	150-S480NBD	150-S480NBR	150S-D48JDC
Solid-State						
400/415 (kW) 460 (Hp)	30...90	17	25...60	150-SB1NBD	150-S1NBR	150S-C90JCD-3B-BP ³
	37...110	20	30...75	150-SB2NBD	150-SB2NBR	150S-D11JCD-3B-BP ³
	47...140	30	40...100	150-SB3NBD	150-SB3NBR	150S-D14JCD-3B-BP ³
	60...180	37	50...150	150-SB4NBD	150-SB4NBR	150S-D18JCD-3B-BP ³
	70...210	40	60...150	150-SC1NBD	150-SC1NBR	150S-D21JCD-3B-BP ³
	87...260	50	75...200	150-SC2NBD	150-SC2NBR	150S-D26JCD-3B-BP ³
	107...320	63	100...250	150-SC3NBD	150-SC3NBR	150S-D32JCD-3B-BP ³
	120...361	75	100...300	150-SD1NBD	150-SD1NBR	150S-D36JCD-3B-BP ³
	140...420	80	125...300	150-SD2NBD	150-SD2NBR	150S-D42JCD-3B-BP ³
174...520	100	150...450	150-SD3NBD	150-SD3NBR	150S-D52JCD-3B-BP ³	

¹ Line and load termination are provided as standard.

² These controllers require a separate 100...240V, 50/60 Hz single-phase control source. To add a control circuit transformer to the enclosure, add the appropriate option code to the catalog number.

³ Requires a bypass contactor. Add **-BP** or **-NB** to the end of the catalog number to denote an IEC or NEMA bypass contactor, respectively. Example: For an IEC bypass contactor, catalog number 150-SB1NBD becomes catalog number 150-SB1NBD-**BP**.

Accessories

Option Modules

Description	Cat. No.
PTC, ground fault & current feedback	150-SM2
Analog I/O: 2 Inputs, 2 outputs	150-SM3
Digital I/O : 4 100...240V AC inputs, 3 relay outputs	150-SM4
Basic parameter configuration	150-SM6
Core Balance Ground Fault Sensor ⁴	825-CBCT

⁴ Used with a Cat. No. 150-SM2.

Communication Modules⁵

Network	Cat. No.
EtherNet/IP	20-COMM-E
Dual-port EtherNet/IP	20-COMM-ER
DeviceNet	20-COMM-D
ControlNet (Coax)	20-COMM-C
PROFIBUS DP	20-COMM-P

⁵ Additional modules are available.

Bypass Kit (Solid State Only)

Description	Cat. No.
C-Frame Bypass Kit (210...320 A)	150-SCBK
D-Frame Bypass Kit (361...520 A)	150-SDBK

Protective Modules

AC Line Voltage (VAC)	Cat. No.
200...480	150-F84L
200...600	150-F86L

Line-Connected Controllers Terminal Lug Kits

Current Rating [A]	Wire Size	Total No. of Line Controller Terminal Lugs		Pkg. Qty.	Cat. No.	Terminal Covers
		Per Line Side	Per Load Side			Cat. No.
Internal Bypass						
108...135 ⁶	#6...250 MCM AWG	3	3	3	199-LF1	150-TC1
201...251 ⁶	16...120 mm ²	6	6	3		150-TC2
317...480 ⁶	#4...500 MCM AWG 25...240 mm ²	6	6	3	199-LG1	150-TC3
Solid-State						
90...180	#6...250 MCM AWG, 16...120 mm ²	3	3	3	199-LF1 ⁷	150-STCB
210...320	#6...250 MCM AWG, 16...120 mm ²	6 ⁸	6	3	199-LF1	-
361...520	#4...500 MCM AWG, 25...240 mm ²	6 ⁸	6	3	199-LG1	-

⁶ When a multi-conductor lug is required, see the SMC-Flex user manual for recommended lugs.

⁷ For SMC-50 Solid-State with External Bypass see SMC Technical Data Document for recommended lugs.

⁸ Six additional line side terminal lugs needed for bypass kit.

Drives



1-72...1-77

For more information on our complete family of soft starter products, please visit:
<https://rok.auto/lv-soft-starters>



Drives

POWER

AC Drives

22F PowerFlex® 4M

- Power ratings of 0.2...11 kW / 0.25...15 Hp at 120V, 240V, and 480V to meet a wide range of applications
- Volts per hertz and slip compensation to meet application demands
- Flexible, time-saving installation using DIN Rail mounting with A and B frame drives
- Feed-through wiring for simple retrofitting into applications requiring variable speed motor control
- Side-by-side mounting in ambient temperatures up to 40 °C (104 °F), saving valuable panel space



Providing powerful motor speed control in a compact, space saving design, the Allen-Bradley® PowerFlex 4M AC drive is the smallest and most cost effective member of the PowerFlex family of drives.

Integral human interface module (HIM) with a 4-digit display for simple configuration

Drives operate up to 50 °C (122 °F) with minimal spacing

5 digital inputs (24V DC, 2 programmable)
1 analog input (unipolar voltage or current)
1 relay (form C)

Feed-through wiring for simple retrofitting

Supports a wide range of communication option cards, including EtherNet/IP and DeviceNet

An integral RS485/DSI port supports low-cost multi-drive networking

A compact footprint requires a 120 mm (4.7 in.) air-flow gap at the top and bottom of the drive, helping save space inside a panel



Circuit Breakers



1-2...1-15

Disconnect Switches



1-16...1-23

Control & Load Switches



1-24...1-27

Contactors



1-28...1-41

Starters



1-42...1-55

Motor Protection



1-56...1-61

Smart Motor Control



1-62...1-71

Product Selection

Single-Phase, 50/60 Hz, No Brake, IP20, NEMA/UL Type Open

Drive Ratings		100...120V AC			200...240V AC			Cat. No. with EMC Filter
kW	Hp	Output Current [A]	Frame Size	Cat. No.	Output Current [A]	Frame Size	Cat. No.	
0.2	0.25	1.6	A	22F-V1P6N103	1.6	A	22F-A1P6N103	22F-A1P6N113
0.4	0.5	2.5	A	22F-V2P5N103	2.5	A	22F-A2P5N103	22F-A2P5N113
0.75	1	4.5	B	22F-V4P5N103	4.2	A	22F-A4P2N103	22F-A4P2N113
1.1	1.5	6	B	22F-V6P0N103	-	-	-	-
1.5	2	-	-	-	8	B	22F-A8P0N103	22F-A8P0N113
2.2	3	-	-	-	11	B	22F-A011N103	22F-A011N113

Three-Phase, 50/60 Hz, No Brake, IP20, NEMA/UL Type Open

Drive Ratings		200...240V AC			380...480V AC			Cat. No. with EMC Filter
kW	Hp	Output Current [A]	Frame Size	Cat. No.	Output Current [A]	Frame Size	Cat. No.	
0.2	0.25	1.6	A	22F-B1P6N103	-	-	-	-
0.4	0.5	2.5	A	22F-B2P5N103	1.5	A	22F-D1P5N103	22F-D1P5N113
0.75	1	4.2	A	22F-B4P2N103	2.5	A	22F-D2P5N103	22F-D2P5N113
1.5	2	8	A	22F-B8P0N103	4.2	A	22F-D4P2N103	22F-B8P0N103
2.2	3	12	B	22F-B012N103	6	B	22F-D6P0N103	22F-D6P0N113
3.7	5	17.5	B	22F-B017N103	8.7	B	22F-D8P7N103	22F-D8P7N113
5.5	7.5	25	C	22F-B025N104	13	C	22F-D013N104	22F-D013N114
7.5	10	33	C	22F-B033N104	18	C	22F-D018N104	22F-D018N114
11	15	-	-	-	24	C	22F-D024N104	22F-D024N114

Specifications

Power Ratings	100...120V: 0.2...1.1 kW / 0.25...1.5 Hp 200...240V: 0.2...7.5 kW / 0.25...10 Hp	380...480V: 0.4...11 kW / 0.5...15 Hp	
Motor Control	Volts per hertz	Slip compensation	-
Application	Open loop speed regulation	-	-
Control I/O	5 digital inputs (24V DC, 2 programmable)	1 analog input (unipolar voltage or current)	1 relay (form C)
Communications	Integral RS485 with Modbus RTU/DSI	Optional: DeviceNet, Bluetooth, EtherNet/IP, PROFIBUS DP, ControlNet, BACnet (Optional networks for use only with external DSI communications kit)	
Control Features	Flying start V/F ratio	Bus regulator Auto Restart	4 preset speeds Multi-drive connectivity (requires communication option card)

Drives



1-72...1-77

For more information on our complete family of compact drives, please visit:
<https://rok.auto/compact-drives>



Drives

POWER

AC Drives 25A PowerFlex® 523

- Power ratings of 0.2...22 kW / 0.25...30 Hp in global voltage classes from 100...600V to meet a wide range of applications
- Modular design features a removable control module that allows simultaneous wiring installation and software configuration to help increase productivity
- AppView® application parameter groups and CustomView™ configuration help speed machine commissioning
- Volts per hertz and sensorless vector control provide flexible motor control options



Allen-Bradley PowerFlex 523 AC drives are designed to help reduce installation and configuration time while offering the control you need for your application. These drives offer convenient programming features and installation flexibility in a cost-effective solution.

Supports a wide range of communication option cards, including dual port EtherNet/IP™ and DeviceNet

An integral RS485/DSI port supports low-cost multi-drive networking

A compact footprint requires a 50 mm (1.96 in.) mounting clearance for air flow at the top and bottom of the drive, helping save space inside a panel



An integral LCD human interface module (HIM) eases configuration with multi-language support and QuickView™ scrolling text to help explain parameters and codes

Drives operate in ambient temperatures from -20... +50 °C (-4...+122 °F). With current derating and a control module fan kit, up to 70 °C (158 °F)

5 digital inputs (24V DC, 4 programmable)
1 analog input (unipolar voltage or current)
1 relay (form C)

Explore the PowerFlex 523 AC drive in our virtual brochure:
<https://rok.auto/PowerFlex520>

Circuit Breakers



1-2...1-15

Disconnect Switches



1-16...1-23

Control & Load Switches



1-24...1-27

Contactors



1-28...1-41

Starters



1-42...1-55

Motor Protection



1-56...1-61

Smart Motor Control



1-62...1-71

Product Selection

Single-Phase

Drive Ratings, Normal & Heavy Duty		100...120V AC, 50/60 Hz			200...240V AC, 50/60 Hz			
kW	Hp	Output Current [A]	Frame Size	Cat. No.	Output Current [A]	Frame Size	Cat. No.	Cat. No. with EMC Filter
0.2	0.25	1.6	A	25A-V1P6N104	1.6	A	25A-A1P6N104	25A-A1P6N114
0.4	0.5	2.5	A	25A-V2P5N104	2.5	A	25A-A2P5N104	25A-A2P5N114
0.75	1	4.8	B	25A-V4P8N104	4.8	A	25A-A4P8N104	25A-A4P8N114
1.1	1.5	6	B	25A-V6P0N104	-	-	-	-
1.5	2	-	-	-	8	B	25A-A8P0N104	25A-A8P0N114
2.2	3	-	-	-	11	B	25A-A011N104	25A-A011N114

Three-Phase

Drive Ratings				200...240V AC, 50/60 Hz			380...480V AC, 50/60 Hz				525...600V AC, 50/60 Hz		
Normal Duty		Heavy Duty		Output Current [A]	Frame Size	Cat. No.	Output Current [A]	Frame Size	Cat. No.	Cat. No. with EMC Filter	Output Current [A]	Frame Size	Cat. No.
kW	Hp	kW	Hp										
0.2	0.25	0.2	0.25	1.6	A	25A-B1P6N104	-	-	-	-	-	-	-
0.4	0.5	0.4	0.5	2.5	A	25A-B2P5N104	1.4	A	25A-D1P4N104	25A-D1P4N114	0.9	A	25A-E0P9N104
0.75	1	0.75	1	4.8	A	25A-B5P0N104	2.3	A	25A-D2P3N104	25A-D2P3N114	1.7	A	25A-E1P7N104
1.5	2	1.5	2	8	A	25A-B8P0N104	4	A	25A-D4P0N104	25A-D4P0N114	3	A	25A-E3P0N104
2.2	3	2.2	3	11	A	25A-B011N104	6	A	25A-D6P0N104	25A-D6P0N114	4.2	A	25A-E4P2N104
4	5	4	5	17.5	B	25A-B017N104	10.5	B	25A-D010N104	25A-D010N114	6.6	B	25A-E6P6N104
5.5	7.5	5.5	7.5	24	C	25A-B024N104	13	C	25A-D013N104	25A-D013N114	9.9	C	25A-E9P9N104
7.5	10	7.5	10	32.3	D	25A-B032N104	17	C	25A-D017N104	25A-D017N114	12	C	25A-E012N104
11	15	11	15	48.3	E	25A-B048N104	24	D	25A-D024N104	25A-D024N114	19	D	25A-E019N104
15	20	11	15	62.1	E	25A-B062N104	30	D	25A-D030N104	25A-D030N114	22	D	25A-E022N104
18.5	25	15	20	-	-	-	37	E	-	25A-D037N114	27	E	25A-E027N104
22	30	18.5	25	-	-	-	43	E	-	25A-D043N114	32	E	25A-E032N104

Specifications

Power Ratings	100...120V: 0.2...1.1 kW / 0.25...1.5 Hp 380...480V: 0.4...22 kW / 0.5...30 Hp	200...240V: 0.2...15 kW / 0.25...20 Hp 525...600V: 0.4...22 kW / 0.5...30 Hp
Motor Control	Volts per hertz	Sensorless vector control Sensorless vector control with Economizer
Application	Open loop speed regulation	-
Control I/O	5 digital inputs (24V DC, 4 programmable)	1 relay (form c) 1 analog input (unipolar voltage or current)
Communications	Integral RS485 with Modbus RTU/DSI PROFIBUS® DP option card	DeviceNet option card Dual port EtherNet/IP option card
Control Features	Flying start V/F ratio Bus regulator Process PID	Common DC bus Fiber application specific features PTC input compatible 1/2 DC bus operation 8 datalinks (4 in and 4 out, requires comm. option card) Multi-drive connectivity (requires comm. option card) 8 preset speeds

Drives



1-72...1-77

For more information on our complete family of compact drives, please visit:
<https://rok.auto/compact-drives>



Drives

POWER

AC Drives 25B PowerFlex® 525

- Power ratings of 0.4...22 kW / 0.5...30 Hp in global voltage classes from 100...600V to meet a wide range of applications
- Standard built-in single port for EtherNet/IP and Safe Torque-off
- AppView application parameter groups and CustomView configuration help speed machine commissioning



Allen-Bradley PowerFlex 525 AC drives are designed to support fast and easy installation and configuration and provide a variety of motor control and flexible mounting options. Available with standard built in EtherNet/IP communications and safe torque-off.

An embedded port for EtherNet/IP supports seamless integration into the Logix environment and EtherNet/IP networks

- 7 digital inputs (24V DC, 6 programmable)
- 2 analog inputs (1 bipolar voltage, 1 current)
- 2 digital outputs
- 1 analog output (1 unipolar voltage or current)
- 2 relays (1 form A relay & 1 form B relay; 24V DC, 120V AC, 240V AC)

Embedded Safe Torque-Off can help to protect personnel



Modular design features a removable control module that allows simultaneous wiring installation and software configuration to help increase productivity

Volts per hertz, sensorless vector control, closed loop velocity vector control and permanent magnet motor control to meet a wide range of applications¹

A built in DSI port supports multi-drive networking, connecting up to five PowerFlex AC drives on one node

¹ Permanent magnet motor control is scheduled for a future firmware release.

Circuit Breakers



1-2...1-15

Disconnect Switches



1-16...1-23

Control & Load Switches



1-24...1-27

Contactors



1-28...1-41

Starters



1-42...1-55

Motor Protection



1-56...1-61

Smart Motor Control



1-62...1-71

Product Selection

Single-Phase

Drive Ratings, Normal & Heavy Duty		100...120V AC, 50/60 Hz			200...240V AC, 50/60 Hz			
kW	Hp	Output Current [A]	Frame Size	Cat. No.	Output Current [A]	Frame Size	Cat. No.	Cat. No. with EMC Filter
0.4	0.5	2.5	A	25B-V2P5N104	2.5	A	25B-A2P5N104	25B-A2P5N114
0.75	1	4.8	B	25B-V4P8N104	4.8	A	25B-A4P8N104	25B-A4P8N114
1.1	1.5	6	B	25B-V6P0N104	-	-	-	-
1.5	2	-	-	-	8	B	25B-A8P0N104	25B-A8P0N114
2.2	3	-	-	-	11	B	25B-A011N104	25B-A011N114

Three-Phase

Drive Ratings				200...240V AC, 50/60 Hz			380...480V AC, 50/60 Hz				525...600V AC, 50/60 Hz		
Normal Duty		Heavy Duty		Output Current [A]	Frame Size	Cat. No.	Output Current [A]	Frame Size	Cat. No.	Cat. No. with EMC Filter	Output Current [A]	Frame Size	Cat. No.
kW	Hp	kW	Hp										
0.4	0.5	0.4	0.5	2.5	A	25B-B2P5N104	1.4	A	25B-D1P4N104	25B-D1P4N114	0.9	A	25B-E0P9N104
0.75	1	0.75	1	4.8	A	25B-B5P0N104	2.3	A	25B-D2P3N104	25B-D2P3N114	1.7	A	25B-E1P7N104
1.5	2	1.5	2	8	A	25B-B8P0N104	4	A	25B-D4P0N104	25B-D4P0N114	3	A	25B-E3P0N104
2.2	3	2.2	3	11	A	25B-B011N104	6	A	25B-D6P0N104	25B-D6P0N114	4.2	A	25B-E4P2N104
4	5	4	5	17.5	B	25B-B017N104	10.5	B	25B-D010N104	25B-D010N114	6.6	B	25B-E6P6N104
5.5	7.5	5.5	7.5	24	C	25B-B024N104	13	C	25B-D013N104	25B-D013N114	9.9	C	25B-E9P9N104
7.5	10	7.5	10	32.3	D	25B-B032N104	17	C	25B-D017N104	25B-D017N114	12	C	25B-E012N104
11	15	11	15	48.3	E	25B-B048N104	24	D	25B-D024N104	25B-D024N114	19	D	25B-E019N104
15	20	11	15	62.1	E	25B-B062N104	30	D	25B-D030N104	25B-D030N114	22	D	25B-E022N104
18.5	25	15	20	-	-	-	37	E	-	25B-D037N114	27	E	25B-E027N104
22	30	18.5	25	-	-	-	43	E	-	25B-D043N114	32	E	25B-E032N104

Specifications

Power Ratings	100...120V: 0.2...1.1 kW / 0.25...1.5 Hp 380...480V: 0.4...22 kW / 0.5...30 Hp	200...240V: 0.2...15 kW / 0.25...20 Hp 525...600V: 0.4...22 kW / 0.5...30 Hp
Motor Control	Volts per hertz	Sensorless vector control Sensorless vector control with Economizer
Application	Open loop speed regulation	-
Control I/O	5 digital inputs (24V DC, 4 programmable)	1 relay (form c) 1 analog input (unipolar voltage or current)
Communications	Integral RS485 with Modbus RTU/DSI PROFIBUS® DP option card	DeviceNet option card Dual port EtherNet/IP option card
Control Features	Flying start, Fiber application specific features, 8 datalinks (4 in and 4 out), V/F ratio, Common DC bus, Position control, Bus regulator, 1/2 DC bus operation, StepLogic Function (Relay & Timers), Process PID, Regulation with encoder feedback or analog input, 16 preset speeds, PTC input compatible, Multi-drive connectivity (requires communication option card)	

Drives



For more information on our complete family of compact drives, please visit:
<https://rok.auto/compact-drives>



Additional Power Products

CrossBoard® System

The CrossBoard System provides flexibility in motor control and protection devices. The out-of-the-box system is provided as one complete base unit, a bus structure with touch-safe plastic housing, which can be directly assembled and fitted with components after unpacking. Components simply snap onto the CrossBoard without tools, meaning the connection is automatic. Available in two widths (225 and 405 mm), the base units can be combined by adding a supply module to bridge the base units.

- Space saving and clear, clean design
- High degree of safety with IEC 61439 and UL 508 standard ratings, including IP20 touch-safe protection
- Out-of-the-box system that saves substantial time on installation and maintenance
- System components plug in easily without tools
- Up to 100 A UL (125 IEC)



Available in two widths

A True Plug and Play Power Distribution System



Three mounting options:

Standard DIN

- 225 mm - up to 2 kg
- 405 mm - up to 2 kg

Deep Profile DIN

- 225 mm - up to 2 kg
- 405 mm - up to 2 kg

Panel Mounted

- Recommended

Circuit Breakers



1-2...1-15

Disconnect Switches



1-16...1-23

Control & Load Switches



1-24...1-27

Contactors



1-28...1-41

Starters



1-42...1-55

Motor Protection



1-56...1-61

Smart Motor Control



1-62...1-71

ArmorStart® Distributed Motor Controllers

- Offers EtherNet/IP™ or DeviceNet™ communication capabilities and Embedded Switch Technology
- Offers local disconnecting means, embedded field I/O, and local logic that uses DeviceLogix® software
- Offers LED status and diagnostic indication
- Includes a hardened, wash-down rating with the ability to mount the device near the motor or machine, which provides shorter cable runs
- Allows the ability to choose factory installed options for specific applications
- Is suitable for group installations with high short circuit current rating
- Available for use with round quick connect power media or fixed pipe and wire



Learn more about the On-Machine Solution from the Armor Start virtual demo:
<https://rok.auto/VBR-Armorstart>

MachineAlert™ Dedicated Function Motor Protection Relays 809S/813S/814S/817S

- Programmable latching or inhibit at set level
- Adjustable time delay settings
- Three-phase devices are powered by the measuring circuit
- LED indication for relay, alarm, and power supply
- Global application with CE and UL approvals
- For product selection, visit <https://rok.auto/directory>.



Drives



1-72...1-77

For more information on our complete family of motor control products, please visit:
<https://rok.auto/motor-control>



Additional Power Products



Molded Case Circuit Breakers

The Bulletin 140UT-D Molded Case Circuit Breaker (MCCB) UL489 and IEC 60947-2 Listed circuit breaker for global applications. The current-limiting circuit breaker provides fixed short-circuit and overcurrent protection and offers high interrupting ratings for 2- and 3-pole devices. These circuit breakers are suitable for back feeding at 240V and 480Y/277V.

- UL 489 and IEC 60947-2 MCCB up to 40A
- Reduce panel footprint with compact design
- Lower heat load with improved thermal performance
- SCCR tested with 100-E, 100-C and 100-K contactors and connecting modules
- Back feeding capability

NEMA Vacuum Contactors

1102C/1104C NEMA vacuum contactors provide motor control system reliability in harsh, dirty environments.

- 1500V AC maximum
- Current ratings: 200, 400, and 600 A
- Visual ON/OFF indicator
- Line and load terminals up front for ease of wiring
- Snap-on side mount auxiliary contacts



Lighting Contactors

The 500LG compact, modular-designed lighting contactors deliver simplicity and versatility in product configuration, to meet a wide range of applications including full-bus and split-bus lighting panelboards.

- Contacts switch ballast (fluorescent or HID), tungsten, and general use loads
- Available in 30 A rating, with up to 12 field-convertible poles (maximum of 8 N.C.)
- Finger and back-of-hand safe power terminals
- Electronically and mechanically held versions



Circuit Breakers



1-2...1-15

Disconnect Switches



1-16...1-23

Control & Load Switches



1-24...1-27

Contactors



1-28...1-41

Starters



1-42...1-55

Motor Protection



1-56...1-61

Smart Motor Control



1-62...1-71



Enclosed At-motor Disconnecting Means

Suitable as at-motor disconnecting means (UL508), available in metal enclosures.

- 140M Motor Protection Circuit Breakers (MPCB)
- 194R Rotary Disconnect Switches

IEC Enclosures for Low Voltage Starters

198E starter enclosures are designed for a multitude of IEC starter configurations. They are available in metal or plastic, and are suitable for either indoor or outdoor environments. The enclosures are rated UL Type 1, 3, 4, 4X, 12, 12K (IP42 to IP66).



Combination Starter, IEC 103H/107H

- Type E and Type F combination motor controllers (UL/CSA)
- 0.1...45 A
- 140M Motor Protection Circuit Breakers
- 100-C / 104-C Contactor
- Factory - installed options available

Drives



1-72...1-77

For more information on our complete family of motor control products, please visit:
<https://rok.auto/motor-control>



Additional Power Products

Enclosed Soft Starters 150, 152, 153

- 90...520 A
- Snap-together wiring technology
- Floor standing Type 1, 12, 3R (IP54) enclosures
- Up to 100 kA Interrupting Capacity



Pump Control Panels

Solutions for a wide variety of pumping applications. Designed for standalone usage, the water-tight NEMA Type 3R enclosure can be placed either indoors or outdoors. With pole mounting brackets on the enclosure, the panel can be installed in remote locations.

- NEMA starters: durable direct-on-line (DOL), up to 200 Hp
- Smart Motor Controllers: five start/stop modes, built-in overload protection, up to 300 Hp
- PowerFlex variable frequency drives up to 250 Hp

Hazardous Locations Solutions

- Copper-free cast aluminum alloy
- Compact designs for inside and outside applications
- Flexible configuration options
- Gasket inside cover to guard against moisture and corrosive elements



Certifications and Ratings

- UL listed/CSA certified
- UL classified enclosures
- Class I Division 1 & 2, Groups C, D
- 65 kA short circuit rating
- Class II Division 1 & 2, Groups E, F & G
- 10,000 A short circuit rating
- NEMA type 3R, 7-9 rated



Circuit Breakers



1-2...1-15

Disconnect Switches



1-16...1-23

Control & Load Switches



1-24...1-27

Contactors



1-28...1-41

Starters



1-42...1-55

Motor Protection



1-56...1-61

Smart Motor Control



1-62...1-71

Modified Industrial Controls

Instead of waiting weeks to get industrial control products with customer requested options, our availability strategy allows our products to be configured as close to the customer as possible.

Configure products such as:

- Enclosed starters
- Stack lights
- Wiring assemblies



Modified Industrial Control Panels

We will turn your high volume custom panels into a repeatable solution with panels tailored to your specifications so you get exactly what you need, when you need it.

Customizable Panels Include:

- Programmable controllers
- Starters
- Distributed I/O
- Servo drives
- Push buttons and pilot lights
- Partner products and other third-party devices



For more information on Modified Industrial Controls, please visit:
<https://rok.auto/modified-icp>



Drives



1-72...1-77

For more information on our complete family of motor control products, please visit:
<https://rok.auto/motor-control>



LOGIC

Relays & Timers

Economy Timing Relays.....	2-2
High Performance Timing Relays	2-2
Tube Base Relays	2-4
Miniature Ice Cube Relays.....	2-6
Slim Line Relays	2-8
Terminal Block Relays.....	2-10
Dial Timing Relay	2-12
NEMA Heavy-Duty Relays.....	2-14
Industrial Control Relays.....	2-16
Safety Control Relays	2-18

Programmable Controllers

Micro Controllers.....	2-20
Connected Components Workbench Software.....	2-21

Control Circuit & Load Protection

Miniature Circuit Breakers.....	2-24
Regional Circuit Breakers.....	2-28
Residual Current Devices.....	2-30
Fuse Holders	2-32
Modular Electronic Circuit Protection.....	2-34

Power Supplies

Switched Mode.....	2-36
Switched Mode Modules	2-41
Uninterruptible Power Supplies	2-42

Power Quality & Energy Management

PowerMonitor 500	2-44
PowerMonitor 1000.....	2-44
PowerMonitor 5000	2-44

Surge & Filter

DIN Rail AC Power Surge Protector	2-46
Filter Protective Devices	2-48

Additional Logic Products

	2-50
--	------

Relays & Timers

LOGIC

Economy Timing Relays 700-FE

- Adjustable functions and timing
- Socket-free DIN Rail mount
- Coil surge protection

High Performance Timing Relays 700-FS

- Additional adjustable functions and timing
- Coil surge protection
- Hazardous location version available



700-FE Economy Timing Relays are a very narrow 17.5 mm wide. They have a timing range of 0.05 s...10 hr. The multi-function version helps reduce your spare parts inventory and standardize your design.

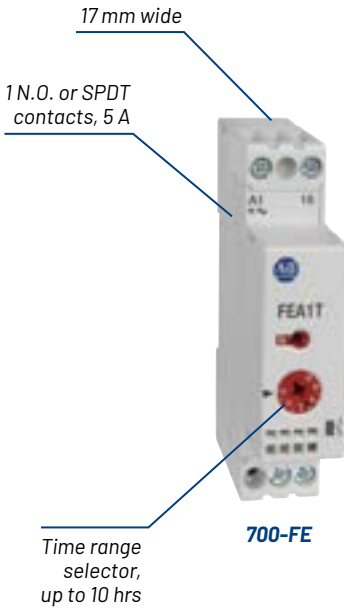

700-FS DIN Rail High Performance Timing Relays have a 22.5 mm space-saving design and a timing range of 0.05 s...60 hr. The multi-function timing helps you reduce stock and standardize your design.

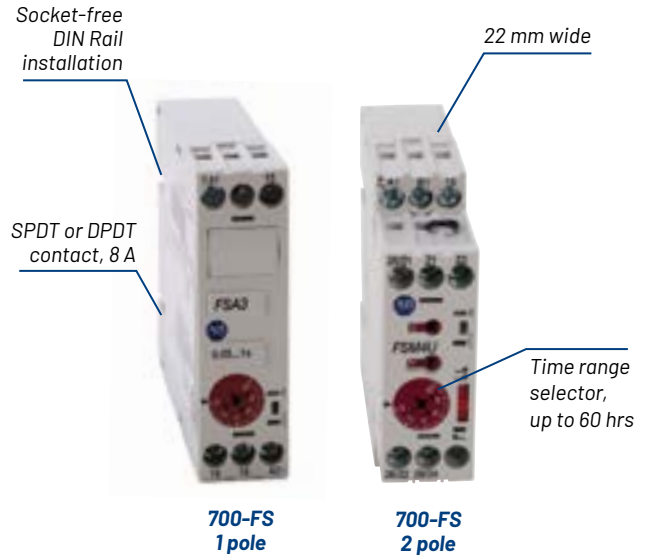

Relays & Timers



2-2...2-19

Programmable Controllers



2-20...2-23

Control Circuit & Load Protection



2-24...2-35

Power Supplies



2-36...2-43

Power Quality & Energy Management



2-44...2-45

Surge & Filter



2-46...2-49

Product Selection

Economy Timing Relays

Operating Mode	Contact Output	Cat. No.
ON-delay	1 N.O.	700-FEAITU22
	SPDT (1 C/O)	700-FEA3TU23
OFF-delay	1 N.O.	700-FEBITU22
	SPDT (1 C/O)	700-FEB3TU23
One Shot	1 N.O.	700-FEDITU22
	SPDT (1 C/O)	700-FED3TU23
ON-delay, OFF-delay, One Shot, Flasher (repeat cycle starting with pulse)	1 N.O.	700-FEMITU22
ON-delay, OFF-delay, One Shot, Flasher (repeat cycle starting with pulse)	SPDT (1 C/O)	700-FEM3TU23
Star-Delta	2 N.O. (1 side common)	700-FEY2QU23

Accessories

700-FE

Description	Pkg. Qty	Cat. No.
Panel mounting adapter - For surface mounting according to drilling plan EN 50002	5	199-FSA

High Performance Timing Relays

Operating Mode	Contact Output	Timing Range	Cat. No.
ON-delay	SPDT 1 C/O Contact	0.05 s...60 hr	700-FSA3UU23
		0.05...1 s	700-FSA3AU23
		0.5...10 s	700-FSA3CU23
0.5...10 min		700-FSA3GU23	
OFF-delay		0.05 s...60 hr	700-FSB3UU23
		0.05...1 s	700-FSB3AU23
		0.5...10 s	700-FSB3CU23
ON- and OFF-delay		0.5...10 min	700-FSB3GU23
		0.05...1 s	700-FSC3AU23
One shot		0.5...10 s	700-FSC3CU23
	0.05...1 s	700-FSD3AU23	
ON-delay	DPDT 2 C/O Contacts	0.5...10 s	700-FSD3CU23
		0.05 s...60 hr	700-FSA4UU23
OFF-delay	(SPDT) 1 C/O	0.05 s...60 hr	700-FSB4UU23
		0.05 s...60 hr	700-FSM3UU23 ²
Multi-function ¹	(DPDT) 2 C/O	0.05 s...60 hr	700-FSM3UZ12
		0.05 s...60 hr	700-FSM4UU23 ²
		0.05 s...60 hr	700-FSM4UZ12
Star-Delta	2 N.O. (1 side common)	1.5 . . 30 s	700-FSY2DU23

¹ Catalog number ending in suffix U23 = input voltage of 24...48V DC/24...240V AC and suffix Z12 = input voltage 12V DC.

² Add **-EX** for hazardous location rating Class I Div 2, Class I, Zone 2, ATEX and IEC EX.

Accessories

700-FS

Description	Pkg. Qty.	Cat. No.
Setting knob with scale (for time setting without tools)	10	700-FSK
Panel mounting adapter (for surface mounting according to drilling plan EN 50 002)	5	199-FSA



Relays & Timers

Tube Base Relays 700-HA

- 10 A contact rating
- DPDT or 3PDT
- Pin-style (8- or 11-pin)
- ON/OFF flag indicator
- LED, push-to-test with manual override options
- Optional bifurcated gold-plated contacts available for low energy switching



Tube-style bases are popular in general-purpose relay applications and meet a wide range of needs with 2-pole (8-pin) and 3-pole (11-pin) options. Socket bases are available in North American (open) and IEC (guarded) styles.

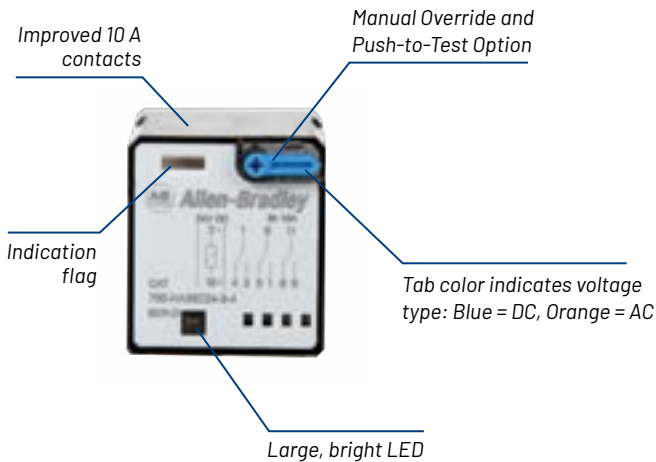

Ideal Applications

- Switching currents or voltage too high for PLC outputs to handle
- Interfacing two or more system voltages - for example, 24V to 120V

Relays & Timers



2-2...2-19

Programmable Controllers



2-20...2-23

Control Circuit & Load Protection



2-24...2-35

Power Supplies



2-36...2-43

Power Quality & Energy Management



2-44...2-45

Surge & Filter



2-46...2-49

Product Selection

Tube Base Relays

Description	Contact Rating	Coil Voltage	Cat. No. ^{1,2,3,4}	
			2-pole (DPDT) 8-pin, 2 Form C	3-pole (3PDT) 11-pin, 3 Form C
General purpose relay single AgNi contact	10 A B300	12V AC	700-HA32A12	700-HA33A12
		24V AC	700-HA32A24	700-HA33A24
		120V AC	700-HA32A1	700-HA33A1
		230V AC	700-HA32A03	700-HA33A03
		240V AC	700-HA32A2	700-HA33A2
		12V DC	700-HA32Z12	700-HA33Z12
		24V DC	700-HA32Z24	700-HA33Z24
		110V DC	700-HA32Z1	700-HA33Z1
		125V DC	700-HA32Z01	700-HA33Z01

- ¹ LED Option: Add suffix **-4** to the selected 700-HA Relay Catalog number; for the 240V AC units, add **-4L**.
- ² Push-to-test, Manual Override, and LED Option: Add suffix **-3-4** to the selected 700-HA Relay Catalog number; for the 240V AC units, add **-3-4L**.
- ³ Push-to-test and Manual Override option: Add suffix **-3** to the selected 700-HA relay.
- ⁴ For Gold-plated bifurcated contacts, please visit <https://rok.auto/directory>.



700-HN100



700-HN205

Accessories

Description	Pkg. Qty.	Cat. No.	
Screw terminal tube base socket - guarded terminal style	2-pole (DPDT) 8-pin	10	700-HN100
	3-pole (3PDT) 11-pin	10	700-HN101
Screw terminal tube base socket open style construction	2-pole (DPDT) 8-pin	10	700-HN125
	3-pole (3PDT) 11-pin	10	700-HN126
Screw terminal tube base socket For use with or without timing/surge suppression module - guarded terminal style	2-pole (DPDT) 8-pin	10	700-HN204
	3-pole (3PDT) 11-pin	10	700-HN205
Diode with LED surge suppressor ⁵	10	700-ADL1R	
Diode surge suppressor ⁵	10	700-ADR	
RC surge suppressor ⁵	10	700-AR2	
Timing module ⁵	1	700-AT3	
Varistor with LED surge suppressor ⁵	10	700-AV3R	
Multi-function multi-range time module ^{5,6}	1	700-HT3	

⁵ Suppressors and timer modules easily plug into sockets (catalog numbers 700-HN204 and 700-HN205). For use with 700-HA relays.

⁶ Catalog number 700-HT3 is wired with signal "S" connected to "A1". See wiring diagram marked on the timer module.



Relays & Timers

Miniature Ice Cube Relays 700-HC

- 7 or 10 A contact ratings
- DPDT or 4PDT
- Blade-style
- ON/OFF flag indicator
- LED, push-to-test with manual override options
- Optional bifurcated gold-plated contacts available for low energy switching



700-HC Miniature Square Base Relays are 2-pole or 4-pole plug-in relays for your low-energy switching applications. The same sockets can be used for DPDT or 4PDT versions, which improves flexibility and reduces inventory.

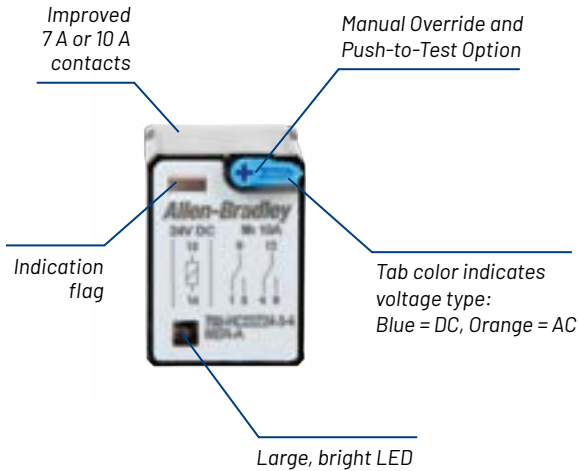

Ideal Applications

- Provides longer life for PLC, saving money and increasing efficiency
- Switching currents or voltages too high for PLC outputs to handle
- Interfacing two or more system voltages - for example, 24V to 120V
- Multiplies PLC outputs by using relays to turn many devices on and off simultaneously
- Provides isolation from solid-state output leakage current

Relays & Timers



2-2...2-19

Programmable Controllers



2-20...2-23

Control Circuit & Load Protection



2-24...2-35

Power Supplies



2-36...2-43

Power Quality & Energy Management



2-44...2-45

Surge & Filter



2-46...2-49



Product Selection

Miniature Ice Cube Relays

Description	Contact Rating	Coil Voltage	Pkg. Qty.	Cat. No. ^{1,2,3,4}
DPDT 2-pole 2 form C contacts: 10 A = AgNi contacts	10 A C300 R300 Low energy rating; (10V, 10 mA)	24V DC	1	700-HC22Z24
		120V AC		700-HC22A1
4PDT 4-pole 4 form C contacts: 7 A = AgNi contacts	7 A C300 R300 Low energy rating; (10V, 10 mA)	24V AC	1	700-HC24A24
		120V AC		700-HC24A1
		240V AC		700-HC24A2
		12V DC		700-HC24Z12
		24V DC		700-HC24Z24
		48V DC		700-HC24Z48

¹ LED option: Add suffix **-4** to the selected 700-HC relay catalog number; for the 240V AC units, add **-4L**.

² Push-to-test and LED option: Add suffix **-3-4** to the selected 700-HC relay catalog number; for the 240V AC units, add **-3-4L**.

³ Push-to-test and Manual Override option: Add suffix **-3** to the selected 700-HC relay.

⁴ For Gold-plated bifurcated contacts, please visit <https://rok.auto/directory>.



700-HN103



700-HN104

Accessories

Description	Pkg. Qty.	Cat. No.
Screw terminal socket - guarded terminal style	10	700-HN103
Screw terminal socket for use with or without timing/surge suppression module - guarded terminal style	10	700-HN104
Screw terminal base socket - Open-style construction	10	700-HN128
Diode with LED surge suppressor ⁵	10	700-ADL1R
Diode surge suppressor ⁵	10	700-ADR
RC surge suppressor ⁵	10	700-AR2
Timing module ⁵	1	700-AT3
Varistor with LED surge suppressor ⁵	10	700-AV3R
Multi-function multi-range time module ^{5,6}	1	700-HT3

⁵ Suppressors and Time Modules easily plug into socket (catalog number 700-HN104). For use with 700-HC relays.

⁶ Catalog number 700-HT3 is wired with signal "S" connected to "A1." See wiring diagram marked on the timer module.



Relays & Timers

Slim Line Relays 700-HK

- 8 A (2-pole) or 16 A (1-pole) contact ratings
- DPDT or SPDT
- Blade-style
- ON/OFF flag indicator
- LED, push-to-test and manual override options
- Standard or gold-plated AgNi contacts
- Maximum duty version available
- Screw or push-in socket terminals

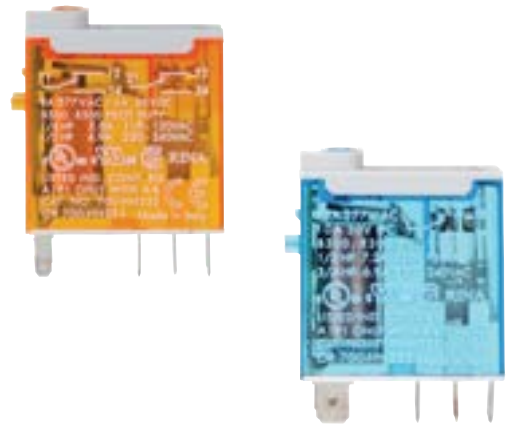

The 700-HK relays are designed for a variety of high-density isolation and interposing applications. Installation is easy and cost effective through the use of the 8-way jumper wiring system that requires only one wire connection to a coil, common or contact power distribution terminal. Optional gold contacts switch low-energy loads reliably as low as 5V, 10 mA, 50 mW.

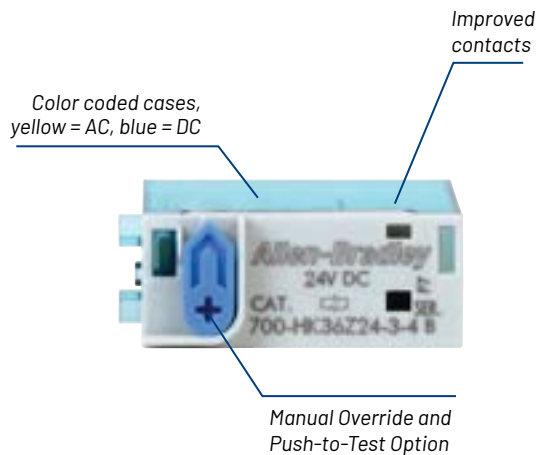

Ideal Applications

- Provides longer life for PLC, saving money and increasing efficiency
- Switching currents or voltages too high for PLC outputs to handle
- Interfacing two or more system voltages – for example, 24V to 120V
- Multiplies PLC outputs by using relays to turn two devices on and off simultaneously
- Provides isolation from solid-state output leakage current

Relays & Timers



2-2...2-19

Programmable Controllers



2-20...2-23

Control Circuit & Load Protection



2-24...2-35

Power Supplies



2-36...2-43

Power Quality & Energy Management



2-44...2-45

Surge & Filter



2-46...2-49

Product Selection

Slim Line Relay

Description	Contact Rating	Coil Voltage	Pkg. Qty.	Cat. No. ^{1,2,3}
SPDT 1-pole 1 form C AgNi contacts	16 A	24V AC	1	700-HK36A24
		120V AC		700-HK36A1
		240V AC		700-HK36A2
		12V DC		700-HK36Z12
		24V DC		700-HK36Z24
		110V DC		700-HK36Z1
DPDT 2-pole 2 form C AgNi contacts	8 A	24V AC	1	700-HK32A24
		120V AC		700-HK32A1
		240V AC		700-HK32A2
		12V DC		700-HK32Z12
		24V DC		700-HK32Z24
		110V DC		700-HK32Z1

¹ LED option: Add suffix **-4** to the selected 700-HK relay catalog number; for the 240V AC units, add **-4L**.

² Push-to-test and LED option: Add suffix **-3-4** to the selected 700-HK relay catalog number; for 240V AC units, add suffix **-3-4L**.

³ For AgNi contact with gold plating: Replace **3** with **X** in catalog number. For example, catalog number 700-HK**3**6A1 becomes catalog number 700-HK**X**6A1.

Accessories

Description	Pkg. Qty.	Cat. No.
Screw terminal socket - guarded terminal style, accepts forked lug conductors. ⁵	10	1-pole, 5-blade, 10 A 700-HN121
		2-pole, 8-blade, 5 A 700-HN122
Push-in terminal socket ⁵	10	1-pole, 5-blade 700-HN223
Screw terminal socket for use with or without timing/surge suppression module - guarded terminal style ^{4,5}	10	1-pole, 5-blade, 16 A 700-HN221
		2-pole, 8-blade, 8 A 700-HN222
Push-in terminal socket ⁵	10	2-pole, 8-blade 700-HN224
8-way jumper (can be cut to length)	1	Red 700-HN180R
	1	Grey 700-HN180G
	1	Blue 700-HN180B

⁴ Suppressors and time modules easily plug into socket (catalog number 700-HN221). For use with 700-HK relays.

⁵ Socket includes retainer clip.



700-HN221



700-HN223



700-HN222



700-HN224

Sales Offices and Distributors

Our network of sales offices and distributors offers exceptional knowledge and service to help you design, implement and support your automation investment.

<https://rok.auto/buy>



Relays & Timers

LOGIC

Terminal Block Relays 700-HL / 700-HL Next Gen

- Terminal Block style (1-pole: 6.2 mm wide)
- 6 A (1-pole) or 10 A (2-pole) contact rating
- Screw or spring-clamp terminal (700-HL) & screw or push-in terminals (700-HL Next Gen)
- Silver or gold contacts
- LED, reverse polarity and surge protection
- Replaceable relay modules
- Wide range voltage input (700-HL Next Gen)



700-HL Terminal Block Relays work in a variety of high-density isolation and interposing applications. The thin per-pole interface (6.2 mm wide) and quick connections help reduce installation costs. Optional leakage current suppression circuit design addresses nuisance coil turn-on or contact non-drop-out concerns for TRIAC controller outputs. The spring-clamp terminal base option is ideal for applications that are subject to vibration.

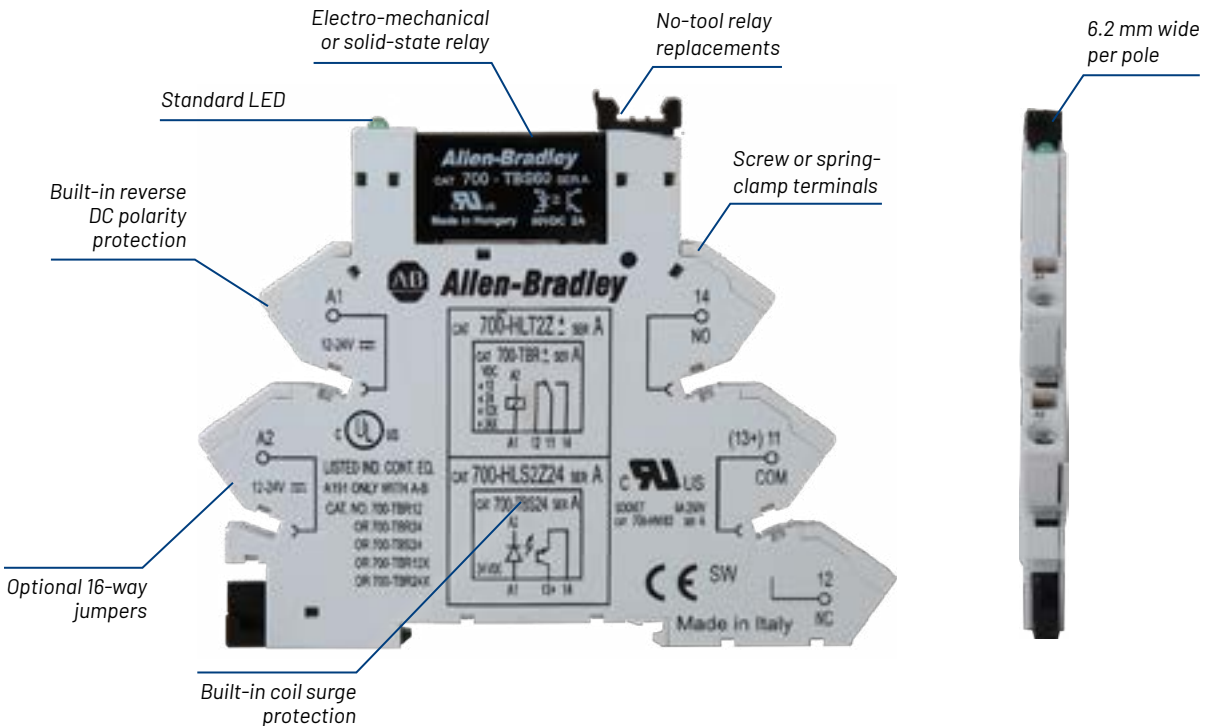

Relays & Timers



2-2...2-19

Programmable Controllers



2-20...2-23

Control Circuit & Load Protection



2-24...2-35

Power Supplies



2-36...2-43

Power Quality & Energy Management



2-44...2-45

Surge & Filter



2-46...2-49

Product Selection

Terminal Block Relay – 1-pole

Assembled Devices Input Voltage	Output Type	Pkg. Qty.	Screw Terminals	Spring-Clamp Terminals	Solid-State			
					Screw Terminals (DC Output)	Spring Clamp Terminals (DC Output)	Screw Terminals (AC Output)	
Cat. No. ¹								
24V DC	SPDT (1 C/O); $I_{th} = 6$ A	10	700-HLT1Z24 ³	700-HLT2Z24	700-HLS1Z24 ³	700-HLS2Z24	700-HLS1Z24	
24V AC/DC			700-HLT1U24	700-HLT2U24	-	-	-	
110/125V AC/DC			700-HLT1U1 ³	700-HLT2U1	700-HLS1U1 ³	700-HLS2U1	700-HLS1U1	
220...240V AC/DC			700-HLT1U2 ³	700-HLT2U2	700-HLS1U2 ³	700-HLS2U2	700-HLS1U2	
Built-in LCSC (leakage current suppression circuit) ^{2,3}			120V AC and 125V DC	700-HLT1L1 ³	-	700-HLS1L1 ³	-	700-HLS1L1
			240V AC	700-HLT1L2 ³	-	700-HLS1L2 ³	-	700-HLS1L2

Terminal Block Relay – 1 and 2 Pole Screw and Push-in

Input Voltage	Pkg. Qty.	Cat No. (Screw Terminals)	Cat No. (Push-in Terminals)	Cat No. (Screw Terminals) (DC Output)	Cat No. (Push-in Terminals) (DC Output)	Cat No. (Screw Terminals) (AC Output)	Cat No. (Push-in Terminals) (AC Output)
12V AC/DC	10	700-HLTN1U12	700-HLTN2U12	-	-	-	-
24V AC/DC	10	700-HLTN1U24	700-HLTN2U24	700-HLSN1U24	700-HLSN2U24	700-HLSN1U24	700-HLSN2U24
24...240V AC/DC ⁴	10	700-HLTN1U18	700-HLTN2U18	700-HLSN1U18	700-HLSN2U18	700-HLSN1U18	700-HLSN2U18

Terminal Block Relay – 2-pole

Assembled Devices Input Voltage	Output Type	Pkg. Qty.	Screw Terminals	Spring-Clamp Terminals
			Cat. No. ¹	
12V DC	DPDT (2 C/O); $I_{th} = 10$ A	10	700-HLT1Z212	700-HLT2Z212
24V DC			700-HLT1Z224	700-HLT2Z224
24V AC/DC			700-HLT1Z2U24	700-HLT2Z2U24
110/125V AC/DC			700-HLT1Z2U1	700-HLT2Z2U1
220...240V AC/DC			700-HLT1Z2U2	700-HLT2Z2U2

¹ For gold-plated contacts, add the letter **X** at the end of the catalog number. For example: if catalog number 700-TBR24 is required with gold plating, it becomes catalog number 700-TBR24X. Gold-plated contacts are not available in the two-pole 12 and 48V DC relays.

² Leakage current suppression up to 2.2 mA off state current.

³ Electromechanical relay to solid-state relay interchangeability is possible.

⁴ Leak current suppression up to 2.2 mA off state current.

Hazardous location versions available.



Relays & Timers

LOGIC

Dial Timing Relay 700-HR

- Timing range from 0.05 s...300 hr
- 5 A contact ratings or transistor outputs
- Socket- or panel-mount
- Single- or multi-function
- Multi-voltage inputs
- Up to 8 timing functions



700-HR Dial Timing Relays are plug-in, socket-mounted timing relays. They are easy to set, and can be panel- or DIN Rail-mounted.

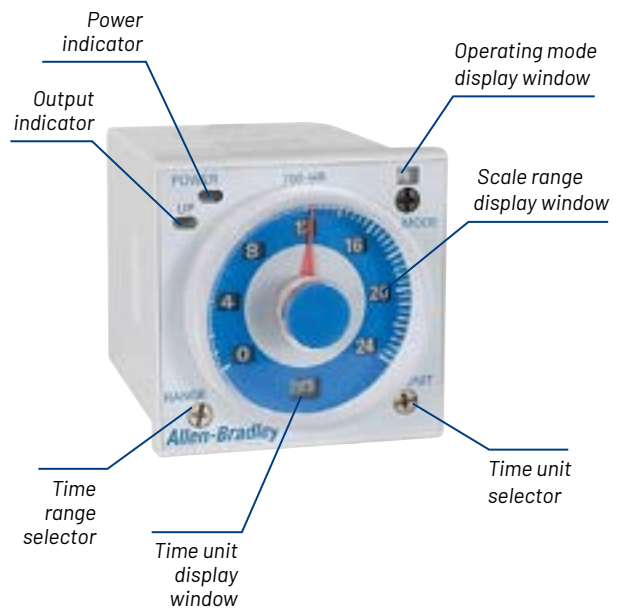

Relays & Timers



2-2...2-19

Programmable Controllers



2-20...2-23

Control Circuit & Load Protection



2-24...2-35

Power Supplies



2-36...2-43

Power Quality & Energy Management



2-44...2-45

Surge & Filter



2-46...2-49

Product Selection

Dial Timing Relay

Timing Mode	No. of Pins	Input Voltage	Contact Output	Cat. No. ¹
ON-delay (A), OFF-delay (D) One Shot (E), Repeat cycle OFF-Start (B), Repeat cycle ON-start (B2), Signal ON/OFF-delay (C), Delayed One Shot (J), Signal ON/OFF - delay (G)	11	24...48V AC 12...48V DC	DPDT	700-HR52TU24
		100...240V AC 100...125V DC		700-HR52TA17 ²
ON-delay (A), One Shot (E), Repeat cycle OFF-start (B), Repeat cycle ON-start (B2), Delayed One Shot (J)	8	24...48V AC 12...48V DC	SPDT timed + instantaneous contact	700-HRS42TU24
		24...48V AC/DC		700-HRP42TU24
		100...240V AC 100...125V DC		700-HRS42TA17
ON-delay (A)	8	24...48V AC/DC	SPDT timed + instantaneous contact	700-HRC12TU24
		24...48V AC 12...48V DC	DPDT	700-HRM12TU24
		100...240V AC	SPDT timed + instantaneous contact	700-HRM12TA17
Repeat cycle OFF-start (B)	8	12...48V DC/24...48V AC	DPDT	700-HRF72DU26
		100...125V DC/100...240V AC		700-HRF72DU27
Repeat cycle ON-start (B2)	8			700-HRF82DU27

¹ Star-Delta model also available.

² Compatible with connections to 3-wire sensors.



700-HN100

Accessories

Description	Pkg. Qty.	Cat. No.
Screw terminal socket - guarded terminal style	8-pin	700-HN100
	11-pin	700-HN101
Frame adapter - For flush or door mounting	1	700-HN130
Protective cover	1	700-HN132



Need Help?

The Rockwell Automation Support Center is your 24/7 support for the answers you need now.

<https://rok.auto/support>



Relays & Timers

LOGIC

NEMA Heavy-Duty Relays 700-P

- NEMA and IEC ratings
- 600V maximum AC/DC
- Broad current switching options (10 A, 20 A, 35 A)
- For machine tool and other heavy-duty applications



Heavy-Duty Relays have four types of contact cartridges to meet your specific switching requirements. Time delay, latching attachments, overlapping, and logic reed contacts can be combined into one relay to yield a custom-tailored application solution.

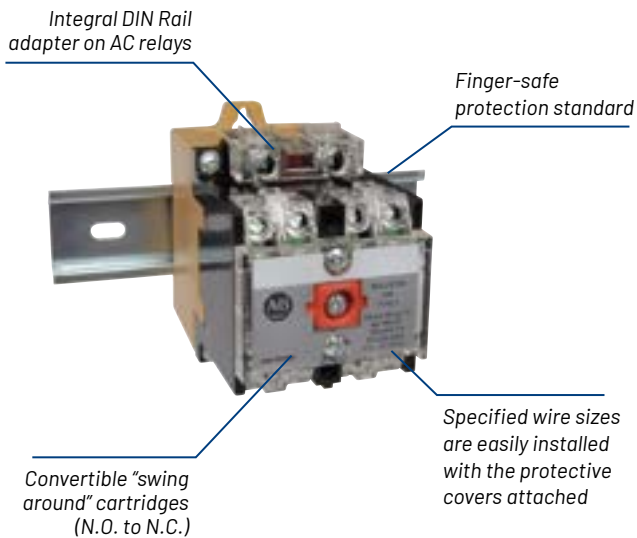

Relays & Timers



2-2...2-19

Programmable Controllers



2-20...2-23

Control Circuit & Load Protection



2-24...2-35

Power Supplies



2-36...2-43

Power Quality & Energy Management



2-44...2-45

Surge & Filter



2-46...2-49

Product Selection

NEMA Heavy-Duty Modular Relay = Base Blank Relay + Contact Cartridge Kit + Adder Decks (optional) + Operating Coil

Base Relays (up to 4 poles)

Description	Coil	Cat. No.
Base blank relay	AC	110/120V AC 700-P◆00A1
	DC	24V DC 700DC-P◆00Z24

◆ Change symbol to **0,2,4** for number of poles required. 2 and 4 pole models include standard contact cartridge.

Individual Cartridge Selection

Description	Cat. No.
Standard contact cartridge - 10A	700-CP1
Master cartridge - 20A	700-CPM

Contact Cartridge Kits

Description	Package Contents	Cat. No.
Master cartridge relay kit	(4) Master contact cartridges 20 A rating	700-PMCKIT
Heavy-duty contact relay kit	Master cartridge kit, plus: (4) jumper terminals (to make two 35 A power pole contacts)	700-PHDKIT



Standard
contact cartridge
700-CP1



Master
contact cartridge
700-CPM

Adder Decks

Device Description	Additional Contact Cartridge Kits Required	Cat. No.
8 pole device	1 additional kit	700-PB00
12 pole device	2 additional kits	700-PB00 (Qty. 1) 700-PC00 (Qty. 1)

AC Operating Coils

Coil Volts	60 Hz Cat. No.	50 Hz Cat. No.
24	PA013	PA407
110 ¹	-	PA236
115...120 ¹	PA236	-
110...115 ²	-	PA322
120	PA322	-

¹ This coil is optimized for 115...120V, 60 Hz applications and will operate satisfactorily at 110V, 50 Hz.

² This coil is optimized for 110...115V, 50 Hz applications and will operate satisfactorily at 120V, 60 Hz.



Product Selection Tools

Available online or for download, our tools help you access info while in the office or on the go.

<https://rok.auto/selection>



Relays & Timers

LOGIC

Industrial Control Relays 700-K Mini

- Bifurcated contacts for low-level signals
- Optional integrated coil protection diode

700-CF / 700-EF

- Mechanically linked contact performance
- Gold-plated, bifurcated version for low level switching (700-CF)
- Master control relay version rated 15 A (AC-15 (700-CF)
- Electronic coils (700-EF)
- Wide control voltage range (700-EF)
- Add on auxiliary control blocks (front or side mount)



700-K, 700-CF and 700-EF IEC control relays are compact industrial relays capable of switching low-energy signals and providing features required for demanding industrial applications – mechanically linked contacts, timing options, long contact life – in an IEC design. These relays share accessories with the equivalent 100 IEC contactors.

Wide range of accessories to meet your application requirements

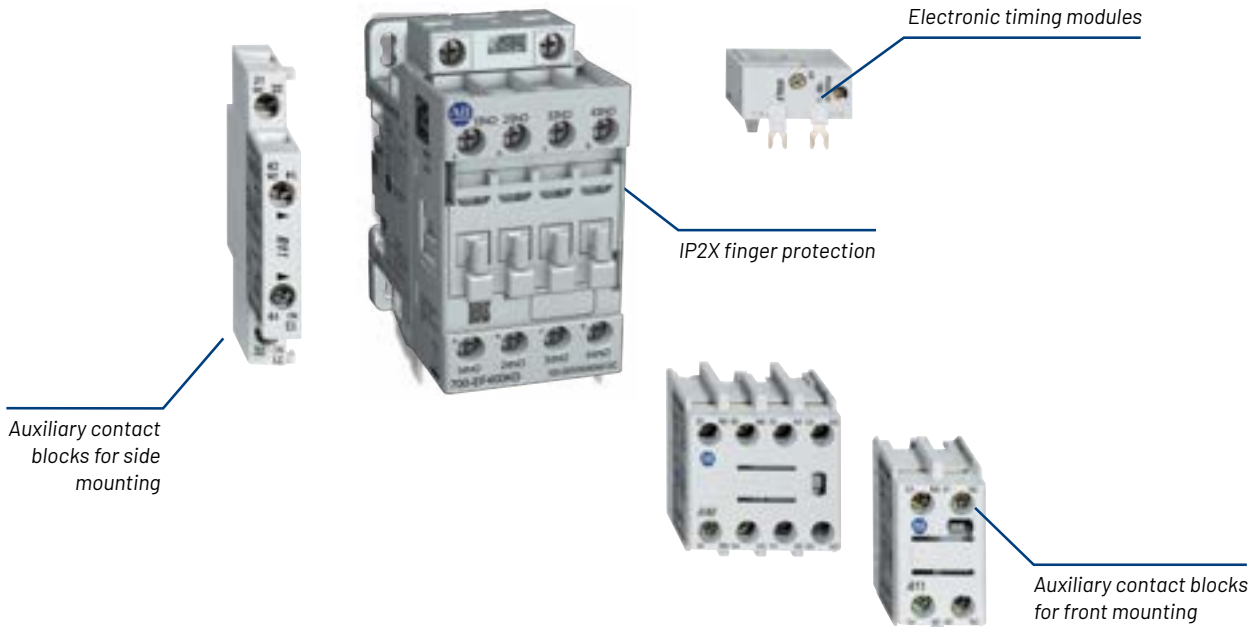

Relays & Timers



2-2...2-19

Programmable Controllers



2-20...2-23

Control Circuit & Load Protection



2-24...2-35

Power Supplies



2-36...2-43

Power Quality & Energy Management



2-44...2-45

Surge & Filter



2-46...2-49

Product Selection

Control Relays

AC-12 I_{th} [A]		AC-15 I_b [A]		No. of Contacts		Screw Terminals
40 °C	60 °C	240V	400V	N.O.	N.C.	Cat. No.
20	20	10	6	2	2	700-CF220⊗
				3	1	700-CF310⊗
				4	0	700-CF400⊗

⊗ The catalog number as listed is incomplete. Select a coil voltage code from the table below.

Control Relays

AC-12 I_{th} [A]	AC-15 I_b [A]			No. of Contacts		Screw Terminals
</ 40 °C	24V	120V	240V	N.O.	N.C.	Cat. No.
16	6	6	4	2	2	700-EF220-⊗
				3	1	700-EF310-⊗
				4	0	700-EF400-⊗

⊗ The catalog number as listed is incomplete. Select a coil voltage code from the table below.

Miniature Control Relays

AC-12 I_{th} [A]		AC-15 I_b [A]							No. of Contacts		Screw Terminals	Spring Clamp Terminals
40 °C	60 °C	24/48V	120V	240V	400V	500V	600V	690V	N.O.	N.C.	Cat. No.	Cat. No.
10	6	3	2	1	0.6	4	0	700-K40E-⊗	700-KR40E-⊗			
						3	1	700-K31Z-⊗	700-KR31Z-⊗			
						2	2	700-K22Z-⊗	700-KR22Z-⊗			
						1+1 ¹	1+1 ¹	700-KL22Z-⊗	700-KRL22Z-⊗			

¹ Late Break N.C. / Early Make N.O.

⊗ The catalog number as listed is incomplete. Select a coil voltage code from the table above.

⊗ Coil Voltage Codes for AC and DC Control 700-CF / 700-K

AC Control		DC Control	
Code	Description	Code	Description
KJ	24V, 50/60 Hz	EJ	24V electronic (700-CF only)
D	110V, 50 Hz/120V, 60 Hz	ZJ	24V *
KF	230V, 50 Hz	DJ	24V with integrated diode *
K	240V, 60 Hz *		

* 700-K only

⊗ Coil Voltage Codes for 700-EF

AC / DC Control 700-EF	
Code	Description
KJ	24...60V AC
	20...60V DC
KY	48...130V AC/DC
KD	100...250V AC/DC
KN	250...500V AC/DC



Relays & Timers

LOGIC

Safety Control Relays 700-HPS, 700S-EF, 700S-P/-PK

- Designed for use in safety circuits
- NEMA, IEC and general purpose styles
- Mechanically linked contacts



Allen-Bradley® relays designed for use in safety circuits are available in NEMA, IEC and general purpose styles. All feature mechanically linked contacts to comply with applicable IEC standards and are marked accordingly.

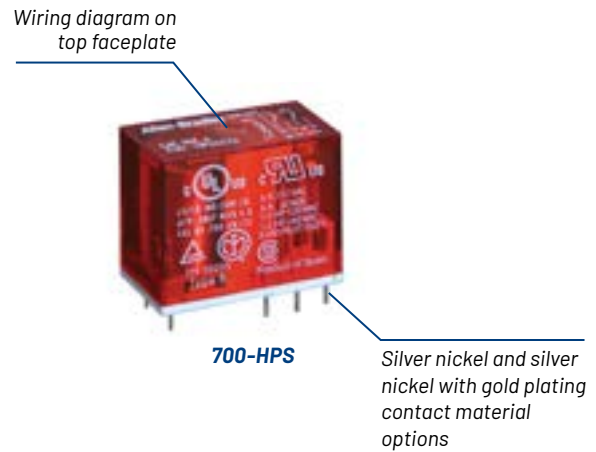
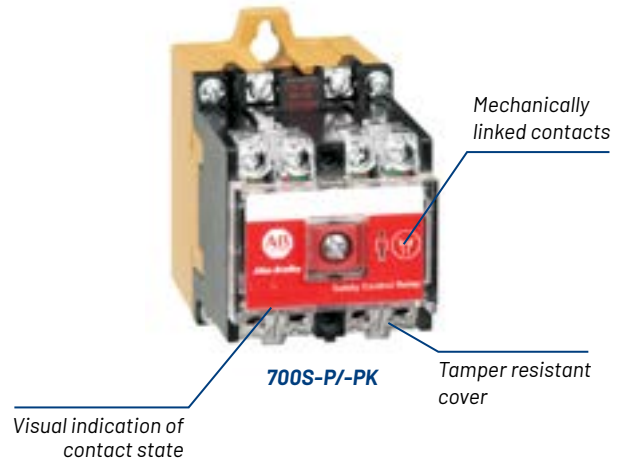
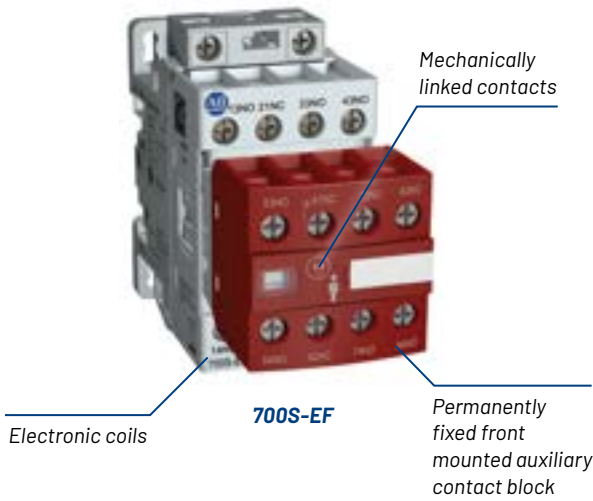

Relays & Timers



2-2...2-19

Programmable Controllers



2-20...2-23

Control Circuit & Load Protection



2-24...2-35

Power Supplies



2-36...2-43

Power Quality & Energy Management



2-44...2-45

Surge & Filter



2-46...2-49

Product Selection

IEC Safety Control Relays ¹

No. of Contacts		Standard Contacts
N.O.	N.C.	Cat. No.
4	4	700S-EF440⊗IC
5	3	700S-EF530⊗IC
6	2	700S-EF620⊗IC

¹ For contact ratings, see 700-EF on page 2-17.

⊗ The catalog number as listed is incomplete. Select a coil voltage code from the table at right.

NEMA Safety Control Relays – Standard, 10 A

No. of Contacts		AC Coils	24V DC Coil
N.O.	N.C.	Cat. No.	Cat. No.
3	1	700S-P310⊗	700S-DCP310DZ24
2	2	700S-P220⊗	700S-DCP220DZ24
7	1	700S-P710⊗	700S-DCP710DZ24
6	2	700S-P620⊗	700S-DCP620DZ24
5	3	700S-P530⊗	700S-DCP530DZ24
4	4	700S-P440⊗	700S-DCP440DZ24
3	5	700S-P350⊗	700S-DCP350DZ24
10	2	700S-P1020⊗	700S-DCP1020DZ24

⊗ The catalog number as listed is incomplete. Select a coil voltage code from the table at right.

NEMA Safety Control Relays – Master, 20 A

No. of Contacts		120V AC Coil	24V DC Coil
N.O.	N.C.	Cat. No.	Cat. No.
7	1	700S-PK710A1	700S-DCPK710Z24
6	2	700S-PK620A1	700S-DCPK620Z24
5	3	700S-PK530A1	700S-DCPK530Z24
4	4	700S-PK440A1	700S-DCPK440Z24
3	5	700S-PK350A1	700S-DCPK350Z24
10	2	700S-PK1020A1	700S-DCPK1020Z24
3	1	700S-PK310A1	700S-DCPK310Z24

⊗ Coil Voltage Codes for AC and DC Control

Code	Description	Code	Description
IEC Safety Control Relays Standard AC/DC		IEC Safety Control Relays Low Consumption	
KJ	24...60V AC 20...60V DC	EQ	12...20V DC
KY	48...130V AC/DC	QJ	24V DC Faster drop out
KD	100...250V AC/DC	EJ	24...60V AC 20...60V DC
KN	250...500V AC/DC		
NEMA Safety Control Relays		NEMA Safety Control Relays	
A24	24V, 60 Hz	Z24	24V DC
B11	110V, 50Hz		
A1	120V, 60 Hz		

General Purpose Safety Control Relays

Description	Coil Voltage	AgNi + Au Gold Plated Contacts	AgNi Contacts
		Cat. No.	Cat. No.
8 A Relay	6V DC	700-HPSXZ06	700-HPSZ206
	12V DC	700-HPSXZ12	700-HPSZ212
	24V DC	700-HPSXZ24	700-HPSZ224
	48V DC	700-HPSXZ48	700-HPSZ248
	60V DC	700-HPSXZ60	700-HPSZ260
	110V DC	700-HPSXZ1	700-HPSZ21
	125V DC	700-HPSXZ01	700-HPSZ201
Socket	-	700-HN123	



Safety

Our innovative safety products and solutions improve the functional operation of your machinery while helping to increase personnel safety, efficiency and productivity.

<https://rok.auto/safety-products>



Programmable Controllers

LOGIC

Micro Controllers

Micro800™ Family, Bulletin 2080

- Wide range of micro controllers (built-in I/O from 10...48 pts)
- Use Connected Components Workbench™ software to program your Micro800 Controllers
- Micro800 Expansion I/O and plug-in modules to customize your controller
- Supports a wide variety of communication protocols to suit specific application needs: EtherNet/IP™, DeviceNet®, Modbus TCP, Modbus RTU, ASCII and Open socket capabilities



Micro800 Control Systems are easy to install and maintain. One software package applies to the entire family. Right-size your controllers for your standalone machines. Invest in the functionality you need, and use Expansion I/O and plug-in modules for a system tailored to your specific application.



Micro810® Controllers Smart Relay Micro PLC

- Offers 12-point controllers
- Includes 8 A outputs, which replace the need for external relays
- Supports program download through USB programming port (adapter required)
- Allows you to configure and operate smart relay function blocks without a PC (LCD required)

* Product selection starts on page 2-22.



Micro820® Controllers Remote Automation Micro PLC

- Offers 20-point controllers
- Provides embedded 0...10V non-isolated 4-channel analog input and 1-channel analog output for speed control of an AC drive
- Communicates via EtherNet/IP and serial
- Supports program download through USB with an optional 3.5 in. remote LCD
- Supports up to two Micro800 plug-in modules

* Product selection starts on page 2-22.

Programmable Controllers

Relays & Timers



2-2...2-19



2-20...2-23

Control Circuit & Load Protection



2-24...2-35

Power Supplies



2-36...2-43

Power Quality & Energy Management



2-44...2-45

Surge & Filter



2-46...2-49

Connected Components Workbench™ Software

- Single software to program your controllers, configure your drives, servo drives and safety relays, and design your human machine interface (HMI) screens
- Easy to Configure – Single software for the Micro Control System reduces machine development time and cost
- Easy to Program – Simplify programming with sample code, user-defined function blocks (UDFB) and user-defined data types (UDDT)
- Easy to Visualize – Reference Micro800 and CompactLogix™ controller variables when creating HMI tags

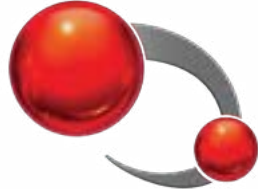

Download Connected Components Workbench software!
<https://rok.auto/ccw>



Micro830® Controllers Flexible Micro PLC with Simple Motion

- Offers 10-point, 16-point, 24-point, and 48-point controllers
- Supports up to five Micro800 plug-in modules
- Provides embedded motion capabilities, up to three axes with 100 kHz pulse train outputs, (PTO)
- Provides embedded communications via USB programming port and non-isolated serial port

* Product selection starts on page 2-22.



Micro870 Controller with Expansion I/O Modules

Micro850® and Micro870® Controllers Scalable Micro PLCs with Ethernet

- Provides embedded communications via non-isolated serial port (for RS-232 and RS-485 communications) and Ethernet port
- Provides embedded motion capabilities: Micro850 – up to three axes with 100 kHz PTO; Micro870 – up to two axes with 100 kHz PTO

Micro850 Controllers

- Supports up to five Micro800 plug-in modules and up to four Micro800 expansion I/O modules
- Offers 24-point and 48-point controllers

Micro870 Controllers

- Twice the memory capacity of Micro850 controller that supports up to 20,000 program steps and up to 128 KB user data
- Supports up to three plug-in modules, up to eight Expansion I/O modules and up to 304 I/O points
- Offers 24-point controllers

* Product selection starts on page 2-23.



Programmable Controllers

Product Selection



Micro810® Controllers, 12 Point

Line Power	Inputs	Outputs	Cat. No.
24V DC	(8) 12/24V DC ¹	(4) relay	2080-LC10-12QWB
120/240V AC	(8) 120/240V AC	(4) relay	2080-LC10-12AWA
24V DC	(8) 12/24V DC ¹	(4) 24V source DC	2080-LC10-12QBB
12V DC	(8) 12V DC ¹	(4) relay	2080-LC10-12DWD
Accessories			
Description		Cat. No.	
USB adapter plug		2080-USBADAPTER	
1.5 in. LCD display and keypad		2080-LCD	
120/240V AC to 24V DC power supply for Micro810, Micro820 and Micro830 10/16pt		2080-PSAC-12W	

¹ Four configurable as analog.



Micro820® Controllers, 20 Point

Line Power	Inputs	Outputs	Cat. No.
24V DC	(12) 24V DC	(7) 24V DC source	2080-LC20-20QBB
	(12) 24V DC	(7) relay	2080-LC20-20QWB
	(8) 120V AC (4) 24V DC	(7) relay	2080-LC20-20AWB
	(12) 24V DC	(7) 24V DC source	2080-LC20-20QBRR
	(12) 24V DC	(7) relay	2080-LC20-20QWBR
	(8) 120V AC (4) 24V DC	(7) relay	2080-LC20-20AWBR
Accessories			
Description		Cat. No.	
Micro800™ 3.5 inch remote LCD display module		2080-REMLCD	
MicroSD™ card 2 GB		2080-SD-2GB	
120/240V AC to 24V DC power supply Micro810, Micro820 and Micro830 10/16pt		2080-PSAC-12W	



Micro830® Controllers, 10...48 Points

Line Power	Inputs	Outputs	Cat. No.
24V DC	(2) normal 24V DC/AC (4) fast 24V DC	(4) relay	2080-LC30-10QWB
	(2) normal 24V DC/AC (4) fast 24V DC	(2) normal 24V DC sink, (2) fast 24V DC sink	2080-LC30-10QVB
	(10) 120V AC	(6) relay	2080-LC30-16AWB
	(6) normal 24V DC/AC (4) fast 24V DC	(4) normal 24V DC sink, (2) fast 24V DC sink	2080-LC30-16QVB
	(6) normal 24V DC/AC (4) fast 24V DC	(6) relay	2080-LC30-16QWB
	(6) normal 24V DC/AC (8) fast 24V DC	(8) normal 24V DC source, (2) fast 24V DC source	2080-LC30-24QBB
	(6) normal 24V DC/AC (8) fast 24V DC	(8) normal 24V DC sink, (2) fast 24V DC sink	2080-LC30-24QVB
	(6) normal 24V DC/AC (8) fast 24V DC	(10) relay	2080-LC30-24QWB
	(28) 120V AC	(20) relay	2080-LC30-48AWB
	(16) normal 24V DC/AC (12) fast 24V DC	(16) normal 24V DC source, (4) fast 24V DC source	2080-LC30-48QBB
	(16) normal 24V DC/AC (12) fast 24V DC	(16) normal 24V DC sink, (4) fast 24V DC sink	2080-LC30-48QVB
	(16) normal 24V DC/AC (12) fast 24V DC	(20) relay	2080-LC30-48QWB
Accessories			
Description		Cat. No.	
120/240V AC to 24V DC power supply for Micro800		2080-PS120-240VAC	

Programmable Controllers

Relays & Timers



2-2...2-19

Control Circuit & Load Protection



2-24...2-35

Power Supplies



2-36...2-43

Power Quality & Energy Management



2-44...2-45

Surge & Filter



2-46...2-49



2-20...2-23

Product Selection

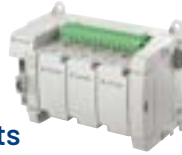

Micro850® Controllers, 24...48 Points

Line Power	Inputs	Outputs	Cat. No.
24V DC	(14) 120V AC	(10) relay	2080-LC50-24AWB
	(14) 24V DC	(10) 24V DC source	2080-LC50-24QBB
	(14) 24V DC	(10) 24V DC sink	2080-LC50-24QVB
	(14) 24V DC	(10) relay	2080-LC50-24QWB
	(28) 120V AC	(20) relay	2080-LC50-48AWB
	(28) 24V DC	(20) 24V DC source	2080-LC50-48QBB
	(28) 24V DC	(20) 24V DC sink	2080-LC50-48QVB
	(28) 24V DC	(20) relay	2080-LC50-48QWB
Accessories			
Description		Cat. No.	
120/240V AC to 24V DC power supply for Micro800		2080-PS120-240VAC	



Expansion I/O Modules

Description	Cat. No.
8-point, 120V AC input	2085-IA8
8-point, 240V AC input	2085-IM8
8-point, 120/240V AC triac output	2085-OA8
16-point, 12/24V DC sink/source input	2085-IQ16
32-point, 12/24V DC sink/source input	2085-IQ32T
16-point, 12/24V DC sink transistor output	2085-OV16
16-point, 12/24V DC source transistor output	2085-OB16
8-point, AC/DC relay output	2085-OW8
16-point, AC/DC relay output	2085-OW16
4-channel, 14-bit isolated voltage/current input	2085-IF4
8-channel, 14-bit isolated voltage/current input	2085-IF8
4-channel, 12-bit isolated voltage/current output	2085-OF4
4-channel, 16-bit RTD and TC isolated input	2085-IRT4
2085 bus terminator	2085-ECR
Expansion power supply module	2085-EP24VDC

Micro870® Controllers, 24 Point



Line Power	Inputs	Outputs	Cat. No.
24V DC	(14) 24V DC	(10) relay	2080-LC70-24QWB
24V DC	(14) 24V DC	(10) 24V DC source	2080-LC70-24QBB



Plug-in Modules¹

Description	Cat. No.
4-channel V/I analog input unipolar 0...20 mA, 0...10V, 12bits (non-isolated)	2080-IF4
2-channel V/I analog input unipolar 0...20 mA, 0...10V, 12bits (non-isolated)	2080-IF2
2-channel V/I analog output unipolar 0...20 mA, 0...10V, 12 bits	2080-OF2
RS232/485 isolated serial port	2080-SERIALISOL
6-channel trim pot analog input	2080-TRIMPOT6
Project, data log, recipe backup and high accuracy RTC 1	2080-MEMBAK-RTC 2080-MEMBAK-RTC2
2-channel RTD (non-isolated)	2080-RTD2
2-channel thermocouple (non-isolated)	2080-TC2
4-point, 12/24V DC sink/source input	2080-IQ4
4-point relay output, individually isolated, 2 A	2080-OW4I
8-point combo, 12/24V DC, sink/source input, 12/24V DC sink output	2080-IQ4OV4
8-point combo, 12/24V DC sink/source input 12/24V DC source output	2080-IQ4OB4
4-point, 24V DC source output	2080-OB4
4-point, 24V DC sink output	2080-OV4
High speed counter, 250 kHz	2080-MOT-HSC
20-node DeviceNet® scanner	2080-DNET20

¹ All plug-in modules are for use with the Micro820, Micro830, Micro850 and Micro870 controllers, except catalog number 2080-MEMBAK-RTC and 2080-MEMBAK-RTC2. 2080-MEMBAK-RTC is for use with Micro830 and Micro850 controllers. 2080-MEMBAK-RTC2 is for use with Micro830, Micro850 and Micro870 controllers.



Control Circuit & Load Protection

LOGIC

Miniature Circuit Breakers 1492-SPM

- Supplemental protection for North America
- Current limiting
- Installation of up to six accessories per circuit breaker
- Reversible line and load connections
- Trip curves: B, C, and D

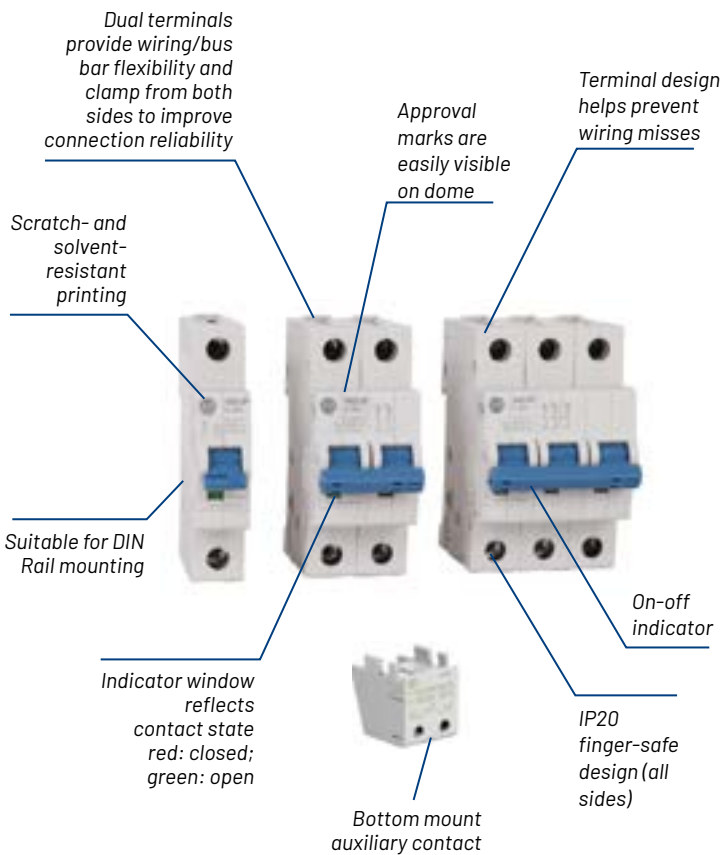

1492-SPM is a thermal-magnetic miniature circuit breaker as defined by IEC Standards. These devices are also rated as supplementary protectors, in North America, providing overcurrent protection for equipment where branch circuit protection is already provided, or is not required.

These supplementary protectors are offered as a broad portfolio of pole variants, current ratings, and trip curves to match the appropriate level of protection for your application. They may be used with bus bars for convenience in panel assembly, a wide range of left-, right- and space saving bottom-mount accessories, and lock out attachments for safety during maintenance.



Control Circuit & Load Protection

Relays & Timers



2-2...2-19

Programmable Controllers



2-20...2-23



2-24...2-35

Power Supplies



2-36...2-43

Power Quality & Energy Management



2-44...2-45

Surge & Filter



2-46...2-49

Product Selection

Miniature Circuit Breakers/Supplemental Protectors

Continuous Current Rating (I_n) [A]	Trip Curve C - Inductive, 5...10 I_n ¹		
	1-Pole ²	2-Pole	3-Pole ²
	Cat. No.	Cat. No.	Cat. No.
0.5	1492-SPM1C005	1492-SPM2C005	1492-SPM3C005
1	1492-SPM1C010	1492-SPM2C010	1492-SPM3C010
2	1492-SPM1C020	1492-SPM2C020	1492-SPM3C020
3	1492-SPM1C030	1492-SPM2C030	1492-SPM3C030
4	1492-SPM1C040	1492-SPM2C040	1492-SPM3C040
5	1492-SPM1C050	1492-SPM2C050	1492-SPM3C050
6	1492-SPM1C060	1492-SPM2C060	1492-SPM3C060
7	1492-SPM1C070	1492-SPM2C070	1492-SPM3C070
8	1492-SPM1C080	1492-SPM2C080	1492-SPM3C080
10	1492-SPM1C100	1492-SPM2C100	1492-SPM3C100
13	1492-SPM1C130	1492-SPM2C130	1492-SPM3C130
15	1492-SPM1C150	1492-SPM2C150	1492-SPM3C150
16	1492-SPM1C160	1492-SPM2C160	1492-SPM3C160
20	1492-SPM1C200	1492-SPM2C200	1492-SPM3C200
25	1492-SPM1C250	1492-SPM2C250	1492-SPM3C250
30	1492-SPM1C300	1492-SPM2C300	1492-SPM3C300
32	1492-SPM1C320	1492-SPM2C320	1492-SPM3C320
40	1492-SPM1C400	1492-SPM2C400	1492-SPM3C400
50	1492-SPM1C500	1492-SPM2C500	1492-SPM3C500
63	1492-SPM1C630	1492-SPM2C630	1492-SPM3C630

¹ The catalog number listed represents Trip Curve C: Inductive. To order Trip Curve B (slightly inductive) replace the **C** in the catalog number with **B**. Example catalog number 1492-SPM1C005 becomes catalog number 1492-SPM1B005.
To order Trip Curve D (highly inductive) replace the **C** in the catalog number with **D**.

² For 1+N and 3+N versions: add the suffix **-N** to the catalog number.



Product Selection Tools

Available online or for download, our tools help you access info while in the office or on the go.

<https://rok.auto/selection>

Accessories

Mounting Position	Description	Contacts	Cat. No.
Right mount	Shunt trip 110...415V AC/ 110...250V DC	-	189-AST1
	Shunt trip 12...60V AC/DC	-	189-AST2
	Auxiliary/signal contact	1 N.O./N.C. (1 C.O.)	189-ASCR3
	Auxiliary contact	1 N.O./N.C. (1 C.O.)	189-AR3
		1 N.O. + 1 N.C.	189-AR11
2 N.C.		189-ARO2	
Bottom mount	Auxiliary contact	1 N.C.	189-ABO1
		1 N.O.	189-AB10

Bus Bars

Description	Without Aux. Contact		With Aux. Contact	
	80 A	100 A	80 A	100 A
	Cat. No. ³	Cat. No. ³	Cat. No. ³	Cat. No. ³
1-phase	1492-A1B8	1492-A1B1	1492-A1B8H	1492-A1B1H
2-phase	1492-A2B8	1492-A2B1	1492-A2B8H	1492-A2B1H
3-phase	1492-A3B8	1492-A3B1	1492-A3B8H	1492-A3B1H

Bus Bar Accessories

Description	Cat. No.
Terminal power feed, 35 mm ² - straight lug	1492-AAT1S
Terminal power feed, 35 mm ² - offset lug low profile	1492-AAT1LP
Dedicated power feed, 50 mm ²	1492-AAT2
End cover, for 1-phase bus bars	1492-A1E
End cover, for 2-, 3-phase bus bars	1492-AME
Protective cover (for unused pins)	1492-AAP

³ Catalog numbers listed are for 1 meter bus bars.

Specifications

Standards Compliance	UL 1077, CSA C22.2 No. 235, EN 60947-2, GB 14048.2
Certifications	UL Recognized - File No. E65138 ⁴ , EAC Certified, CSA Certified - File No. 259391 ⁴ , CE Marked, CCC Certified, VDE Certified, RoHS Compliant
Rated Voltage	UL/CSA: Max. 480Y/277V AC, IEC: Ue 230/400V AC
Interrupting Capacity	UL/CSA: 5...10 kA, IEC: 15 kA

⁴ 1+N and 3+N devices are not UL recognized or CSA certified.



Control Circuit & Load Protection

LOGIC

Miniature Circuit Breakers 1489

- UL/CSA Listed for branch circuit protection
- Current limiting
- Reversible line and load connections
- Attachments available for Lockout/Tagout
- Trip curves: C and D

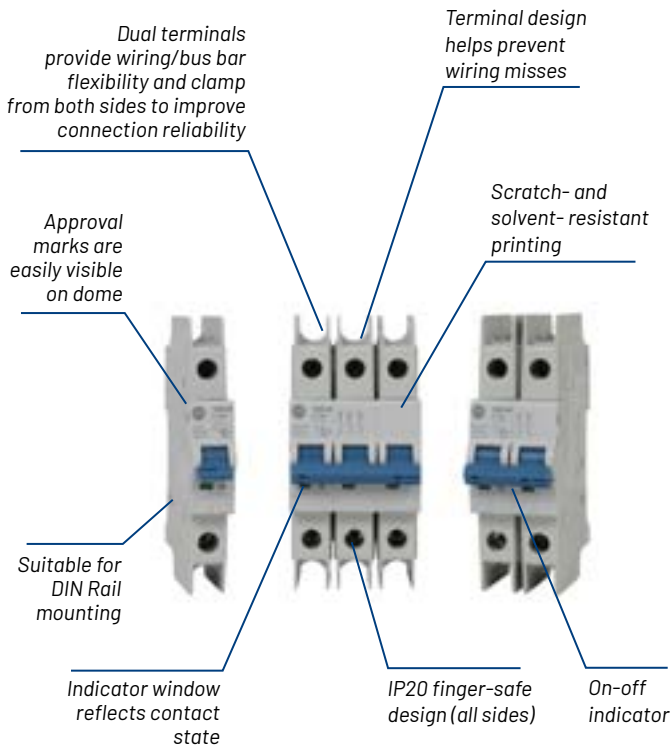

1489-M thermal-magnetic circuit breakers are approved for branch circuit protection in the United States and Canada, and are certified as Miniature circuit breakers for IEC applications.

These branch protectors are compatible with many accessories to meet diverse application needs, including UL 508 Listed bus bars for convenience in panel assembly, auxiliary contacts, signal contacts and shunt trips for versatility, and lockout attachments for safety during maintenance.



Control Circuit & Load Protection

Relays & Timers



2-2...2-19

Programmable Controllers



2-20...2-23



2-24...2-35

Power Supplies



2-36...2-43

Power Quality & Energy Management



2-44...2-45

Surge & Filter



2-46...2-49

Product Selection

Miniature Circuit Breakers

Continuous Current Rating (I_n) [A]	Trip Curve C ¹ - Inductive, 5...10 I_n		
	1-Pole	2-Pole	3-Pole
	Cat. No.	Cat. No.	Cat. No.
0.5	1489-M1C005	1489-M2C005	1489-M3C005
1	1489-M1C010	1489-M2C010	1489-M3C010
1.6	1489-M1C016	1489-M2C016	1489-M3C016
2	1489-M1C020	1489-M2C020	1489-M3C020
3	1489-M1C030	1489-M2C030	1489-M3C030
4	1489-M1C040	1489-M2C040	1489-M3C040
5	1489-M1C050	1489-M2C050	1489-M3C050
6	1489-M1C060	1489-M2C060	1489-M3C060
7	1489-M1C070	1489-M2C070	1489-M3C070
8	1489-M1C080	1489-M2C080	1489-M3C080
10	1489-M1C100	1489-M2C100	1489-M3C100
13	1489-M1C130	1489-M2C130	1489-M3C130
15	1489-M1C150	1489-M2C150	1489-M3C150
16	1489-M1C160	1489-M2C160	1489-M3C160
20	1489-M1C200	1489-M2C200	1489-M3C200
25	1489-M1C250	1489-M2C250	1489-M3C250
30	1489-M1C300	1489-M2C300	1489-M3C300
32	1489-M1C320	1489-M2C320	1489-M3C320
35	1489-M1C350	1489-M2C350	1489-M3C350

¹ The catalog number listed represents Trip Curve C: Inductive. To order Trip Curve D (highly inductive), replace the **C** in the catalog number with **D**. Example: Catalog number 1489-M1C005 becomes Catalog number 1489-M1D005.

Specifications

Standards Compliance	UL 489, CSA C22.2 No. 235, EN 60947-2, GB 14048.2
Certifications	UL Listed, File No. E197878, CSA Certified, CE Marked, CCC Certified, VDE Certified, RoHS Compliant, EAC Certified
Rated Voltage	UL/CSA: Max. 480Y/277V AC IEC: Ue 230/400V AC
Interrupting Capacity	UL/CSA: 10 kA IEC: 15 kA

Accessories

Description	Contacts	Cat. No.
Shunt trip 110...415V AC/110...250V DC	-	1489-AMST1
Shunt trip 12...60V AC/DC	-	1489-AMST2
Signal contact	1 N.O./N.C. (1 C.O.)	1489-AMRS3
Auxiliary contact	1 N.O./N.C. (1 C.O.)	1489-AMRA3

Bus Bars

Description	No. of Pins	No. of Circuit Breakers	Cat. No. ^{2,3,4}
1-phase	6	6	1489-AMCL106
	12	12	1489-AMCL112
	18	18	1489-AMCL118
2-phase	6	3	1489-AMCL206
	12	6	1489-AMCL212
	18	9	1489-AMCL218
3-phase	6	2	1489-AMCL306
	12	4	1489-AMCL312
	18	6	1489-AMCL318

Bus Bar Accessories

Description	Cat. No.
Terminal power feed, 35 mm ²	1489-AMCLT35
Dedicated power feed, 50 mm ²	1489-AMCLT50D
Protective shroud (for unused pins)	1489-AMCLPS

² Package quantity of 10

³ cULus, UL 508, EN 60947-1, CE Marked

⁴ Maximum of three bus bars allowed



Looking for More?
This catalog highlights only our most essential components; for a complete product selection, visit us at:
<https://rok.auto/directory>



Control Circuit & Load Protection

LOGIC

Regional Circuit Breakers 188-J

- Available only in China and Europe
- 0.5...63 A; 1(+N), 2, 3(+N), 4 poles
- Current limiting
- Reversible line and load connections
- Trip curves: B, C, and D



188-J circuit breakers are for application at the equipment level. These products have regional certifications only and are available in China and Europe.

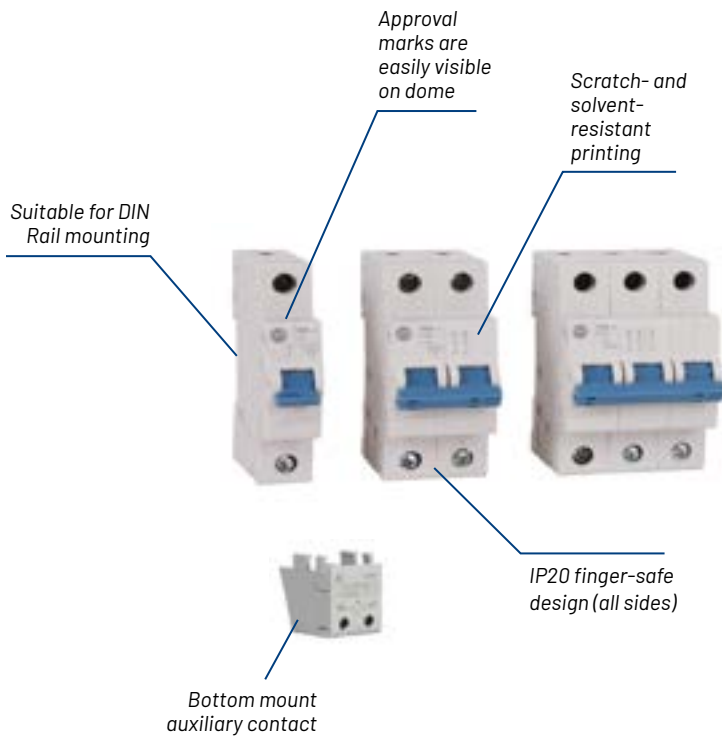

Control Circuit & Load Protection

Relays & Timers



2-2...2-19

Programmable
Controllers



2-20...2-23



2-24...2-35

Power
Supplies



2-36...2-43

Power Quality
& Energy
Management



2-44...2-45

Surge &
Filter



2-46...2-49

Product Selection

Regional Circuit Breakers

Continuous Current Rating (I_n) [A]	Trip Curve C - Inductive, $5...10 I_n^{1,2}$			
	1-Pole ³	2-Pole	3-Pole ³	4-Pole
	Cat. No.	Cat. No.	Cat. No.	Cat. No.
0.5	188-J1C005	188-J2C005	188-J3C005	188-J4C005
1	188-J1C010	188-J2C010	188-J3C010	188-J4C010
2	188-J1C020	188-J2C020	188-J3C020	188-J4C020
3	188-J1C030	188-J2C030	188-J3C030	188-J4C030
4	188-J1C040	188-J2C040	188-J3C040	188-J4C040
6	188-J1C060	188-J2C060	188-J3C060	188-J4C060
8	188-J1C080	188-J2C080	188-J3C080	188-J4C080
10	188-J1C100	188-J2C100	188-J3C100	188-J4C100
13	188-J1C130	188-J2C130	188-J3C130	188-J4C130
16	188-J1C160	188-J2C160	188-J3C160	188-J4C160
20	188-J1C200	188-J2C200	188-J3C200	188-J4C200
25	188-J1C250	188-Ja2C250	188-J3C250	188-J4C250
32	188-J1C320	188-J2C320	188-J3C320	188-J4C320
40	188-J1C400	188-J2C400	188-J3C400	188-J4C400
50	188-J1C500	188-J2C500	188-J3C500	188-J4C500
63	188-J1C630	188-J2C630	188-J3C630	188-J4C630

¹ The catalog number listed represents Trip Curve C: Inductive. To order Trip Curve B (slightly inductive) replace the **C** in the catalog number with **B**. To order Trip Curve D (highly inductive) replace the **C** in the catalog number with **D**.

² Trip Curve B is not available in current ratings 0.5...4 A.

³ For 1+N and 3+N versions: add the suffix -N to the catalog number.

Specifications

Standards Compliance	EN 60898-1, GB 10963
Certifications	CE Marked, CCC Certified, VDE Certified, EAC Certified
Rated Voltage	IEC: Ue 230/400V AC
Interrupting Capacity	IEC: 10 kA

Accessories

Mounting Position	Description	Contacts	Cat. No.
Right mount	Shunt trip 110...415V AC/ 110...250V DC	-	189-AST1
	Shunt trip 12...60V AC/DC	-	189-AST2
	Auxiliary/signal contact	1 N.O./N.C. (1 C.O.)	189-ASCR3
	Auxiliary contact	1 N.O./N.C. (1 C.O.)	189-AR3
		1 N.O. + 1 N.C.	189-ART1
		2 N.C.	189-AR02
2 N.O.		189-AR20	
Bottom mount	Auxiliary contact	1 N.C.	189-AB01
		1 N.O.	189-AB10

Bus Bars

Description	Pkg. Qty.	Without Aux. Contact		With Aux. Contact	
		No. of Pins	Cat. No.	No. of Pins	Cat. No.
1-phase	1	60	189-CL1	38	189-CL1H
	20	12	189-CL1I2	9	189-CL1H09
	20	6	189-CL106	6	189-CL1H06
	20	2	189-CL102	2	189-CL1H02
2-phase	1	58	189-CL2	44	189-CL2H
	10	12	189-CL2I2	10	189-CL2H10
	10	6	189-CL206	6	189-CL2H06
	10	4	189-CL204	4	189-CL2H04
3-phase	1	60	189-CL3	48	189-CL3H
	10	12	189-CL3I2	12	189-CL3H12
	10	6	189-CL306	6	189-CL3H06
4-phase	1	56	189-CL4	48	189-CL4H

Description	Pkg. Qty.	No. of Pins	Cat. No.
2-phase MCB to RCD	10	4	189-CL204
4-phase MCB to RCD	10	8	189-CL408

Bus Bar Accessories			
Terminal power feed, 25 mm ²	10	-	189-CLT25
Terminal power feed, 50 mm ²	10	-	189-CLT50
Dedicated power feed, 50mm ²	10	-	189-CLT50D
End cover, for 1-phase bus bars	10	-	189-CL1EC
End cover, for 2, 3 phase bus bars	10	-	189-CL3EC
End cover, for 4 phase bus bars	10	-	189-CL4EC
Protective cover (for unused pins)	10	-	189-CLPS



Control Circuit & Load Protection

LOGIC

Residual Current Devices 1492-RCDA

- 25...80 A residual current devices
- 30 mA sensitivity devices for personnel protection
- Reversible line and load connections
- Suitable for protection against AC and pulsating DC (rectified AC) earth leakage current
- Dual terminals allow a more secure connection of two wires, or both a wire and bus bar



By detecting small leakage currents and disconnecting all ungrounded connectors quickly, RCDs can prevent injury to exposed personnel and damage to equipment.

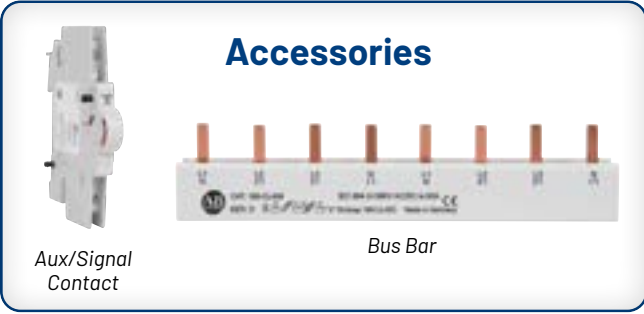

Control Circuit & Load Protection

Relays & Timers



2-2...2-19

Programmable Controllers



2-20...2-23



2-24...2-35

Power Supplies



2-36...2-43

Power Quality & Energy Management



2-44...2-45

Surge & Filter



2-46...2-49

Product Selection

Residual Current Devices

Sensitivity (mA)	Rated Current (A)	2-Pole (1-Pole + Neutral)		4-Pole (3-Pole + Neutral)		
		Ut min = 110V	Ut min = 170V	Ut min = 110V	Ut min = 110V (With Delay)	Ut min = 170V
30	25	1492-RCDA2A25-US	1492-RCDA2A25	1492-RCDA4A25-US	-	1492-RCDA4A25
	40	1492-RCDA2A40-US	1492-RCDA2A40	1492-RCDA4A40-US	-	1492-RCDA4A40
	63	-	-	1492-RCDA4A63-US	-	1492-RCDA4A63
	80	-	-	-	-	1492-RCDA4A80
100	25	1492-RCDA2B25	-	1492-RCDA4B25	-	-
	40	1492-RCDA2B40	-	1492-RCDA4B40	1492-RCDA4B40S	-
	63	-	-	1492-RCDA4B63	1492-RCDA4B63S	-
300	25	1492-RCDA2C25	-	1492-RCDA4C25	-	-
	40	1492-RCDA2C40	-	1492-RCDA4C40	1492-RCDA4C40S	-
	63	-	-	1492-RCDA4C63	1492-RCDA4C63S	-
	80	-	-	1492-RCDA4C80	-	-
500	25	-	-	1492-RCDA4D25	-	-
	40	-	-	1492-RCDA4D40	-	-
	63	-	-	1492-RCDA4D63	-	-
	80	-	-	1492-RCDA4D80	-	-
Diagram						

Accessories

Contact Blocks

Description ^{1,2,3}	Contacts	Cat. No.
Auxiliary/signal contact	1 N.O./N.C. (1 C.O.)	189-ASCR3

- A maximum of one C.O. type signal contact and one C.O. type auxiliary contact OR two C.O. type auxiliary contacts may be installed per 1492-RCD.
- A maximum of one 189-AR11, -AR02, or AR20 auxiliary contact may be installed per 1492-RCD. They may not be combined with C.O. type contacts.
- A maximum of three accessories of any type may be installed per 1492-RCD. The signal contact must be mounted closest to the RCD, then the auxiliary contact(s). For allowed combinations and installation instructions, please contact your local Rockwell Automation sales office or Allen-Bradley distributor.

Bus Bars

Description	Pins	Pkg. Qty.	Cat. No. ⁴
2-Phase MCB to RCD	4	10	189-CL204
4-Phase MCB to RCD	8	10	189-CL208

⁴ These devices are CE marked, but not certified to any UL, CSA, or other standard.

Specifications

Standards Compliance	UL 1053, ANSI/NFPA 70, EN 61008, CSA C22.2 No. 144, GB 16916
Certifications	cURus Recognized, File No. E53935, CE Marked, CCC Certified, VDE Certified, RoHS Compliant, EAC Certified
Rated Voltage	UL/CSA: Max. 480Y/277V AC IEC: Ue 230/400V AC
Interrupting Capacity	Rated conditional short-circuit 10 kA (SCPD - fuse gG 100 A) Rated residual breaking capacity 1 kA



Control Circuit & Load Protection

LOGIC

Fuse Holders 1492-FB

- For Class CC, J and Midget fuses
- Compact size
- Handle isolates the fuse from top-wired power when installing or removing fuse
- Terminals are shipped in open position
- Optional blown fuse indicator



Optional blown fuse indicators for easy circuit troubleshooting



Terminal power feed



Busbar

Label holder

Suitable for DIN Rail mounting

IP20 finger-safe design (front)

The 1492-FB fuse holder family is designed for use in many OEM applications, such as power supplies, equipment protection, primary and secondary control transformers, solenoids, lighting and heater loads, and drives.

1492-FB fuse holders provide a safe and convenient means for installation of Class CC, J and Midget fuses. To support correct fuse type installation, the Class CC fuse holder is designed to reject a Midget fuse or international 10 x 38 mm fuse. The Class J fuse holder will reject all fuses other than a Class J fuse.

All fuse holders are UL Listed and CSA Certified for branch circuit protection. They are excellent for wire protection, small motor loads, and group protection of small motor loads. The Midget fuse holder is also CE Marked for 10 x 38 mm IEC Midget fuses.

Control Circuit & Load Protection

Relays & Timers



2-2...2-19

Programmable Controllers



2-20...2-23



2-24...2-35

Power Supplies



2-36...2-43

Power Quality & Energy Management



2-44...2-45

Surge & Filter



2-46...2-49

Product Selection

Fuse Holders

Description	Midget Fuse	Class CC Fuse	Class J Fuse		
	30 A	30 A ¹	30 A	60 A	
1-Pole	Fuse block	1492-FB1M30	1492-FB1C30	1492-FB1J30	1492-FB1J60
	Fuse block with indication, 110...600V ²	1492-FB1M30-L	1492-FB1C30-L	1492-FB1J30-L	1492-FB1J60-L
	Fuse block with indication, 12...72V	1492-FB1M30-D1	1492-FB1C30-D1	-	-
	Pieces per carton	12	12	6	6
2-Pole	Fuse block	1492-FB2M30	1492-FB2C30	1492-FB2J30	1492-FB2J60
	Fuse block with indication, 110...600V ²	1492-FB2M30-L	1492-FB2C30-L	1492-FB2J30-L	1492-FB2J60-L
	Pieces per carton	6	6	3	3
3-Pole	Fuse block	1492-FB3M30	1492-FB3C30	1492-FB3J30	1492-FB3J60
	Fuse block with indication, 110...600V ²	1492-FB3M30-L	1492-FB3C30-L	1492-FB3J30-L	1492-FB3J60-L
	Pieces per carton	4	4	2	2

¹ All major fuse brands and current ranges have been evaluated for this fuse holder. Due to the heat they generate, the following fuses must be derated: Mersen ATOR 1.25 I = 0.42 A max., Mersen ATQR 1.40 I = 0.47 A max.

² 690V when used in IEC applications.

Specifications

Certifications	UL Listed, File No. E34648, CSA Certified, CE Marked
Standards Compliance	UL 512, CSA 22.2 No. 39, EN 60269-2

Accessories

Description	Size	Pkg. Qty.	Cat. No.
Fuse holder identification slide-in markers (blank marker squares slip into molded slot. 100 markers/card)	5 mm x 5 mm	5 cards	1492-MC5X5
	6 mm x 5 mm		1492-MC6X5

Bus Bars

Description	Devices Per Meter	80 A	100 A
		Cat. No.	Cat. No.
1 phase	57	1492-A1B8	1492-A1B1
2 phase	29	1492-A2B8	1492-A2B1
3 phase	19	1492-A3B8	1492-A3B1
Bus Bar Accessories			
Description			Cat. No.
Terminal Power Feed, 35 mm ² - offset lug			1492-AAT1
End Cover, for 1 phase bus bars			1492-A1E
End Cover, for 2, 3 phase bus bars			1492-AME
Protective cover (for unused pins)			1492-AAP



Sales Offices and Distributors

Our network of sales offices and distributors offers exceptional knowledge and service to help you design, implement and support your automation investment.

<https://rok.auto/buy>



Control Circuit & Load Protection

LOGIC

Modular Electronic Circuit Protection 1694

- Clear status indication by means of multicolor LED and auxiliary contact (located in power feed)
- Selective load protection by means of electronic trip curve
- No tools required at commissioning
- Width per channel only 12.5 mm (1-channel) or 6.25 mm (2-channel)



Protection models are fed from power module and attached by attaching with built-in levers

Optional AUX contact for signaling any of the attached modules has tripped

Input feed from power supply, up to 40 A

Push-in Terminals for time-saving wiring



Bulletin 1694 Electronic Circuit Protection (ECP) Modules protect the secondary circuit of 24V DC switched mode power supplies. The modular system can handle multiple channels or 40 A of total current consumption. Designed for 24V DC circuits, 1694 Electronic Circuit Protectors provide comprehensive protection against short circuit and overcurrent conditions while allowing for inrush current.

1694 Electronic Circuit Protectors	
Voltage	24V DC (18...30V DC)
Output Current	1...10 A (1-channel) 1 A/1 A...6 A/6 A (2-channel) 1...4 A NEC Class 2
Standards Compliance	UL 2387, File No. E350272 UL 1310 NEC Class 2 cULus508, File No. E56639
Certifications	CE Marked RoHS Compliant China RoHS Morocco EMC WEEE RCM Australia UKCA United Kingdom

Control Circuit & Load Protection

Relays & Timers



2-2...2-19

Programmable Controllers



2-20...2-23



2-24...2-35

Power Supplies



2-36...2-43

Power Quality & Energy Management



2-44...2-45

Surge & Filter











2-46...2-49

Product Selection

Power Feed Modules

Mounting Position	Supply Voltage	Max Current	Aux Contact	Pkg. Qty.	Cat. No.
Left	24V DC	40 A	No	1	1694-PF1244
	24V DC	40 A	Yes	1	1694-PFA1244
	0V Ground	40 A	No	1	1694-PF1G4
	24V DC	40 A	No	1	1694-PFD1244 
Middle	24V DC	40 A Line Separated	No	1	1694-PF2L4S
Middle or Right	24V DC	40 A Line Connected	No	1	1694-PF3L4C
	0V Ground	40 A	No	1	1694-PF3G4

Protection Modules

Number of Channels	Fixed or Adjustable Current	Current	Pkg. Qty.	Cat. No.
1	Fixed	1 A	4	1694-PM11 ¹
		2 A	4	1694-PM12 ¹
		3 A	4	1694-PM13 ¹
		4 A	4	1694-PM14 ¹
		6 A	4	1694-PM16
		8 A	4	1694-PM18
		10 A	4	1694-PM110
2		1 A	4	1694-PM211 ¹
		2 A	4	1694-PM222 ¹
		3 A	4	1694-PM233 ¹
		4 A	4	1694-PM244 ¹
		6 A	4	1694-PM266
		8 A	4	1694-PMD18 
1		10 A	4	1694-PMD110 
2	1 A	4	1694-PMD211 ¹ 	
	2 A	4	1694-PMD222 ¹ 	
	3 A	4	1694-PMD233 ¹ 	
	4 A	4	1694-PMD244 ¹ 	
	6 A	4	1694-PMD266 	
	Adjustable ²	1..10 A	4	1694-PMD2A10 

¹ For Class 2 power supply, add **-CL2** to the end of the catalog number (for example 1694-PM11-CL2)

² Can be used Standard and/or IO-Link devices

 IO-Link enabled.

Distribution Modules (can be used Standard and/or IO-Link devices)

Description	Pkg. Qty.	Cat. No.
10 Terminals, 1xLINE, 9xLOAD, I _{max} 20A	1	1694-DM1L2
10 Terminals, 2xLINE, 4xLOAD, I _{max} 20A	1	1694-DM2L2
10 Terminals, Ground, I _{max} 20A	1	1694-DM3G2



Power Supplies

Power Supplies 1606

- Intelligent circuit design with long-life electrolytic capacitors
- Allows 20% continuous (XLE/XLD family) or 50% temporary (XLS family) additional power reserve without reducing output voltage, while minimizing ripple and noise
- Redundancy modules or power supplies with built-in redundancy provide a means for managing multiple power supplies for back-up power
- Compact size saves valuable panel space



Allen-Bradley efficiency = smaller enclosures

These thermal images show the difference an efficient power supply can make in a panel. All three power supplies are using the same transformer, but the Allen-Bradley power supply has the whole package running cooler due to its more efficient design.

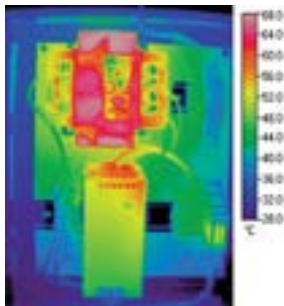

A-B 1606-XLS - 10A, 24V DC - 93% Efficiency

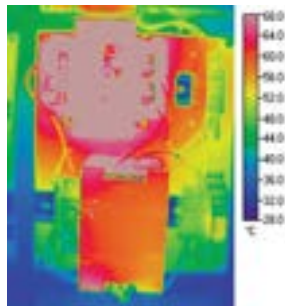

Competitor A - 10A, 24V DC - 91% Efficiency

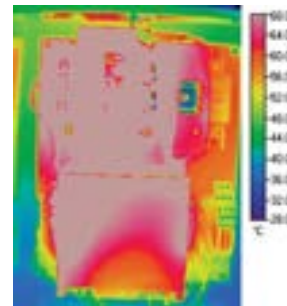

Competitor B - 10A, 24V DC - 84% Efficiency

Selection Criteria

Power Supply Family	Basic 1606-XLB	Essential 1606- XLE	DC-DC Converter 1606-XLD	Compact 1606-XLP	Performance 1606-XLS
Input Voltage	Single phase	Single/multi phase	DC Voltage	Single/multi phase	Single/multi phase
Watt Range	36...480W	80...960 W	92...240 W	15...100 W	80... 960 W
Multiple Output Voltages	24...28V DC	X	24, 48V DC	X	X
Terminations	Screw, push-in	Screw, cam lock spring, plug, push-in	Cam lock spring, screw	Cam lock spring, screw,	Cam lock spring, screw
Auto Select Input	X	X	-	X	X
Power Boost	-	120%	120%	-	150%/5 s
DC OK Relay Output	X	X	X	X	X
DC OK LED Indicator	X	X	X	X	X
Conformal Coat for Harsh Environments	-	X	-	-	X
Hazardous Location Approvals	-	X	X	X	X

Relays & Timers



2-2...2-19

Programmable Controllers



2-20...2-23

Control Circuit & Load Protection



2-24...2-35

Power Supplies



2-36...2-43

Power Quality & Energy Management



2-44...2-45

Surge & Filter



2-46...2-49



Product Selection – 1606-XLB

Basic Power Supplies – Single-phase

Input Voltage	Output Voltage [V DC]	Output Power [W]	Output Current [A]	Steady-state Input Current [V AC]		Cat. No.	
				@ 120V AC	@ 230V AC		
AC 100...240V	24...28	36	1.5	0.6	0.38	1606-XLB36EH	
AC 100...240V	12...15	60	5	1.0	0.6	1606-XLB60BH	
AC 100...240V	24...28	60	2.5	1.0	0.6	1606-XLB60EH	
AC 100...240V		60	2.5	1.0	0.6	1606-XLB60E	
AC 100...240V		90	90	3.75	1.45	0.95	1606-XLB90EH
AC 100...240V				3.75	1.45	0.95	1606-XLB90E
AC 100...240V				3.75	1.45	0.95	1606-XLB90EQ
100...120/200...240V AC		120	120	5	1.72	1.05	1606-XLB120E
100...240V AC		240	240	10	2.17	1.18	1606-XLB240E
AC 100...240V		480	480	60	4.3	2.3	1606-XLB480E



Product Selection – 1606-XLD

Basic Power Supplies – Single-phase

Input Voltage	Output Voltage [V DC]	Output Power [W]	Output Current [A]	Steady-state Input Current [V DC]		Cat. No.
				@ 24V DC	@ 48V DC	
24	24	92	3.8	4.25		1606-XLDC92D
24	24	240	10	10.5		1606-XLDD240E
48	24	120	5		2.75	1606-XLDF120E
48	48	240	5		5.3	1606-XLDF240F



Power Supplies



Product Selection - 1606-XLE

Essential Power Supplies

LOGIC

Phase	Input Voltage	Output Voltage [V DC]	Output Power [W]	Output Current [A]	Steady-state Input Current [V AC / V AC]		Cat. No.	
					120	230		
1	100...240V AC	24...28	80	3.3	1.24	0.68	1606-XLE80E	
			120	5	1.09	0.6	1606-XLE120E	
			120	5	1.09	0.6	1606-XLE120EC ¹	
	100...120V AC		120	5	1.94	-	1606-XLE120EN	
	200...240V AC		120	5	2.2	-	1606-XLE120EE	
	100...240V AC		240	10	2.15	1.13	1606-XLE240E	
	100...120V AC		240	10	3.84	-	1606-XLE240EN	
	200...240V AC		240	10	2.2	-	1606-XLE240EE	
	100...120V/200...240V AC		48...52	240	5	0.7	0.6	1606-XLE240F
	110...300V DC		48...56	480	10	4.26	2.23	1606-XLE480FP-D
2	380...480V AC	12...15	96	8	0.64 / 0.56A @ 3 x 400/480V AC		1606-XLE96B-2	
3		48...56	240	5	0.7 / 0.6A @ 3 x 400/480V AC		1606-XLE240F-3	
2		24...28	120	5	0.75 / 0.68A @ 3 x 400/480V AC		1606-XLE120E-2	
3			240	10	0.7 / 0.6A @ 3 x 400/480V AC		1606-XLE240E-3	
3		24V	960	40	1.4A @ 3 x 480V AC		1606-XLE960DX-3N	
1		AC 100...240V	48...56	260	5.4	2.32	1.20A	1606-XLE260F
24...28	240		10	2.15	1.13A	1606-XLE240EC		
24V	240		10	2.17	1.14A	1606-XLE240ERL		
	240		10	2.17	1.14A	1606-XLE240ERZ		
	240		10	2.17	1.14A	1606-XLE240ECRZ		
24...28	240		10	2.15	1.13A	1606-XLE240EL		
	240		10	2.15	1.13A	1606-XLE240EH		
24V	240		10	2.17	1.14A	1606-XLE240EDRZ		
24...28	120		5	1.09	0.6A	1606-XLE120EL		
	120		5	1.09	0.6A	1606-XLE120EH		
	120		5	1.09	0.6A	1606-XLE120ED		
48...56	120		2.5	1.09	0.6A	1606-XLE120F		
	24V		480	20	4.28	2.25A	1606-XLE480ERL	
			480	20	4.28	2.25A	1606-XLE480ERZ	
480			20	4.28	2.25A	1606-XLE480ECRZ		
24...28	480		20	4.26	2.23A	1606-XLE480EL		
	480		20	4.26	2.23A	1606-XLE480EH		
	480		20	4.26	2.23A	1606-XLE480EM		
	480		20	4.28	2.25A	1606-XLE480EDRZ		

¹ The **C** suffix in the catalog number indicates that the product has conformal coating. Please see technical data for additional catalog numbers available.

Relays & Timers



2-2...2-19

Programmable Controllers



2-20...2-23

Control Circuit & Load Protection



2-24...2-35

Power Supplies



2-36...2-43

Power Quality & Energy Management



2-44...2-45

Surge & Filter



2-46...2-49



Product Selection – 1606-XLP

Compact Power Supplies

Phase	Input Voltage	Output Voltage [V DC]	Output Power [W]	Output Current [A]	Steady-state Input Current [V AC]		Cat. No.
					120	230	
1	100...240V AC, 85...375V DC	5...5.5	15 ¹	3	0.28	0.17	1606-XLP15A
		12...15	15 ¹	1.3	0.28	0.17	1606-XLP15B
		24...28	15 ¹	0.6	0.28	0.17	1606-XLP15E
		5...5.5	25 ¹	5	0.60	0.30	1606-XLP25A
		10...12	30 ¹	3	0.60	0.25	1606-XLP30B
		24...28	30 ¹	1.3	0.60	0.35	1606-XLP30E
		24...28	30 ¹	1.3	0.54	0.30	1606-XLP30EQ
		±12/15	36 ¹	2.8	0.65	0.40	1606-XLP36C
		12...15	50 ¹	4.2	1.00	0.60	1606-XLP50B
		24...28	50 ¹	2.1	0.77	0.44	1606-XLP50E
		24...28	50 ¹	2.1	1.00	0.60	1606-XLP50EZ
		48...56	50 ¹	1	1.00	0.60	1606-XLP50F
	100...240V AC, 110...300V DC	12...15	60 ¹	4.5	0.91	0.54	1606-XLP60BQ
			60 ¹	4.5	0.97	0.61	1606-XLP60BQT
		24...28	72 ¹	2.5	0.98	0.58	1606-XLP60EQ
			90 ¹	2.5	1.05	0.66	1606-XLP60EQT
	100...120/220...240V AC, 220...375V DC	12...15	95 ¹	3	1.60	0.80	1606-XLP72E
			100	7.5	1.90	0.90	1606-XLP90B
	100...200/200...240V AC, 220...375V DC	24...28	100	3.9	2.00	0.95	1606-XLP95E
			90 ¹	4.2	2.10	1.00	1606-XLP100E
		48...56	100	2.1	2.10	1.00	1606-XLP100F
2	380...480V AC	24...28	90	3.75	2 x 0.36 @400...480 V AC		1606-XLP90E-2
			100	4.2	2 x 0.40 @400...480 V AC		1606-XLP100E-2

¹ NEC CLASS 2 Rated



Power Supplies



Product Selection - 1606-XLS

Performance Power Supplies

LOGIC

Phase	Input Voltage	Output Voltage [V DC]	Output Power [W]	Output Current [A]	Steady-state Input Current		Cat. No.
					120 [V AC / V DC]	230 [V AC / V DC]	
1	100...240V AC, 110...300V DC	24...48	80	3.3	1.42	0.82	1606-XLS80E
			120	5	1.10	0.62	1606-XLS120E 1606-XLS120EA
		12...15	180	15	1.65	0.93	1606-XLS180B
	100...240V AC, 110...150V DC	24...48	240	10	2.22	1.22	1606-XLS240E
							1606-XLS240EA ¹
							1606-XLS240EC ¹
	100...240V AC 110...300V DC	24...28	240	10	2.22	1.22	1606-XLS240E-D
		48...56	240	5	2.22	1.22	1606-XLS240F-D
	100...240V AC, 110...150V DC	48...56	240	5	2.22	1.22	1606-XLS240F
		28...32	240	8	2.22	1.22	1606-XLS240K
		24...48	480	20	4.56	2.48	1606-XLS480E
							1606-XLS480EA ¹
	1606-XLS480EC ¹						
	600V DC				0.79A @ 600V DC	1606-XLS480E-D	
	200...240V AC	24...48	480	20	-	4.45	1606-XLS480EE
	100...240V AC, 110...150V DC	48...56	480	10	4.56	2.48	1606-XLS480F
		36...42	480	13.3	4.56	2.48	1606-XLS480G
	200...240V AC, 220...300V DC	24...28	960	34.3	-	4.6	1606-XLS960EE
48...56		960	20	-	4.6	1606-XLS960FE	
100...240V AC	24...28	960	40	8.6	4.5	1606-XLS960E	
100...240V AC	48...56	960	20	8.6	4.5	1606-XLS960F	
100...240V AC 110...300V DC	24...28	240	10	2.22	1.22	1606-XLS240E-D	
100...240V AC 110...300V DC	48...56	240	5	2.22	1.22	1606-XLS240F-D	
3	380...480V AC	24...28	480	20	3 x 0.65V AC @400...480		1606-XLS480E-3
	380...480V AC	48...56	960	10	3 x 0.65V AC @400...480		1606-XLS480F-3
		36...42		13.3			1606-XLS480G-3
		24...28	960	40	3 x 1.35V AC @400...480		1606-XLS960E-3
		48...54		20			1606-XLS960F-3

¹ The **C** suffix in the catalog number indicates that the product has conformal coating. The **A** suffix in the catalog number indicates that the product carries the ATEX rating.

Relays & Timers



2-2...2-19

Programmable Controllers



2-20...2-23

Control Circuit & Load Protection



2-24...2-35

Power Supplies



2-36...2-43

Power Quality & Energy Management



2-44...2-45

Surge & Filter



2-46...2-49

Redundancy Modules 1606

- Provide back-up power in the event the primary power supply fails
- For all switched mode power supply lines
- Status indication for each switched mode power supply



Buffer Modules 1606

- Buffer load currents during typical mains faults, switching events or load peaks
- Prevent application interruption due to short voltage dips, drops or inrush spikes
- 10+ years of life expectancy based on recommended usage

DC UPS Modules

- Back-up power for bridge dips, sags or loss of power
- Extensive diagnostic and monitoring functions to aide in troubleshooting
- When power supply provides sufficient voltage, module charges the battery
- Capacitor and battery-based models available



ArmorPower On-Machine Power Supplies 1607-XT

- IP67 and NEC Class 2 ratings
- Vacuum encapsulation technology
- Quick connectors
- Smooth surface, suitable for washdown



Power Supplies

LOGIX

Uninterruptible Power Supplies 1609-B, 1609-D

- Integrated remote on/off and dry I/O contacts
- USB communications
- Available EtherNet/IP communications (1609-D only)
- Remote on/off enables UPS to deactivate when servicing electrical panel
- Logix integration with add on profiles (1609-D only)



Fast Recovery from Power Failures

The 1609 Uninterruptible Power Supply (UPS) is uniquely designed for the industrial market to provide back-up AC power to the control cabinet. The 1609 UPS will bridge dips, sags, or brief losses of power. If necessary, the 1609 UPS will provide enough time to facilitate a safe shut-down of your industrial PC, PLC, data logging HMI, or any other critical device in the control scheme.

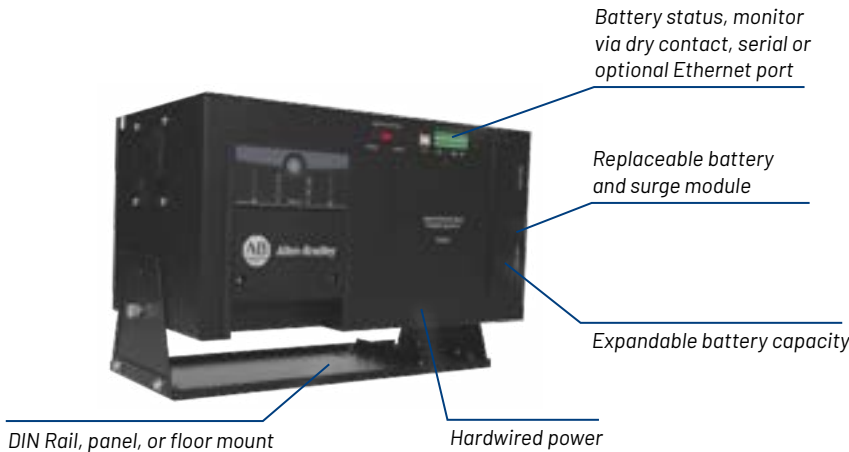

Power Quality Events

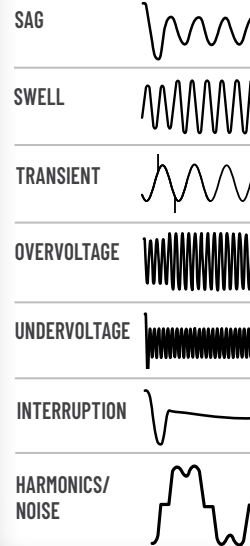

Product	Panel Mount	Integrated Dry I/O Contacts	Remote On/Off	Replaceable Surge Protection	EtherNet/IP	USB	Auto Voltage Regulation	Expandable Battery
1609-B	•	•	•	•		•		
1609-D	•	•	•	•	•	•	•	•

Relays & Timers



2-2...2-19

Programmable Controllers



2-20...2-23

Control Circuit & Load Protection



2-24...2-35

Power Supplies



2-36...2-43

Power Quality & Energy Management



2-44...2-45

Surge & Filter



2-46...2-49

Product Selection

Uninterruptible Power Supplies

Product Family	Input/ Output Voltage [V]	Output Power [VA]	Cat. No.
1609-B Basic ¹	120	600	1609-B600N
		1000	1609-B1000N
	230	600	1609-B600
		1000	1609-B1000E
1609-D Deluxe ² (full featured)	120	600	1609-D600N
		1000	1609-D1000N
		1500	1609-D1500N
	230	600	1609-D600E
		1000	1609-D1000E
		1500	1609-D1500E

¹ 1609-B UPS requires (2) 12V batteries that can be ordered separately from the Accessories table below.

² 1609-D UPS requires (2) 12V batteries that can be ordered separately from the Accessories table below.

Specifications

Input

Capacity		VA	1609-B	1609-D	
		600	600VA (390 W)	600VA (390 W)	
		1000	1000VA (390 W)	1000VA (650 W)	
		1500	N/A	1500VA (980 W)	
Voltage Range 120VAC/230VAC		90...145V/184...264			
Current	1609-B	Input Voltage	600VA	1000VA	1500VA
		120V	5.4 A	8.9 A	N/A
	230V	2.8 A	4.7 A	N/A	
	1609-D	120V	5.5 A	8.8 A	13 A
230V		3.3 A	4.7 A	7.1A	
Capacity Frequency		50/60 Hz +/- 3 Hz			
PFC		None (load power factor is reflected in the input line)			

Output

Capacity		VA	1609-B	1609-D
		600	600VA (390 W)	600VA (390 W)
		1000	1000VA (390 W)	1000VA (650 W)
		1500	N/A	1500VA (980 W)

Accessories

Description	Cat. No.
Standard replacement battery 32...104 °F (0...40 °C)	1609-SBAT
High-temperature replacement battery 32...122 °F (0...50 °C)	1609-HBAT
External battery pack	1609-EXBAT
Surge protection module	1609-SPD
Replacement mounting bracket	1609-BRK



Product Selection Tools

Available online or for download, our tools help you access info while in the office or on the go.

<https://rok.auto/selection>



For more information on our complete family of power supply products, please visit:
<https://rok.auto/power-supplies>

Power Quality & Energy Management

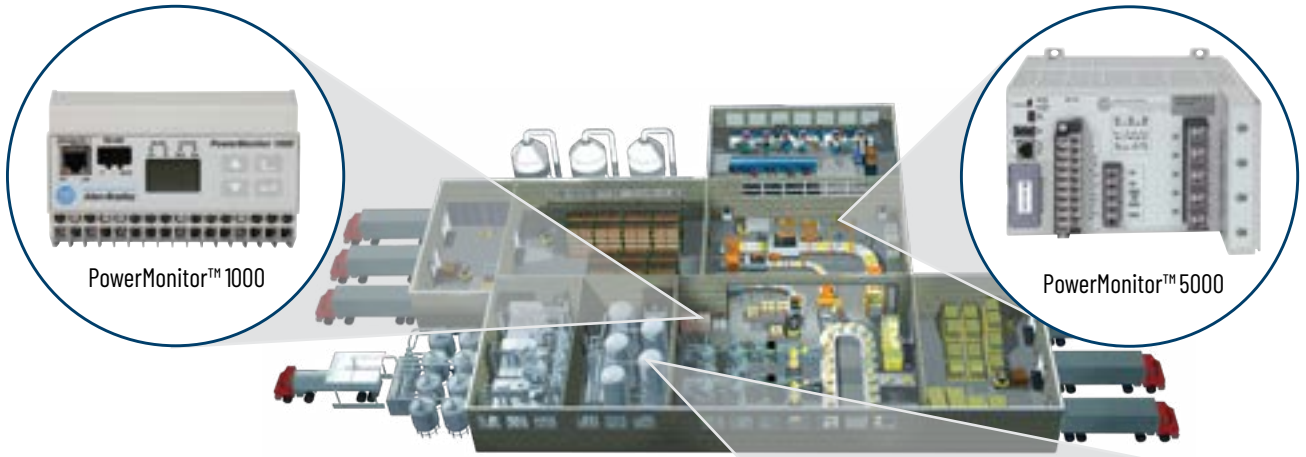

The use of energy monitoring hardware and software products can improve your equipment productivity and life, reduce your power use and its costs, and increase your company's profits. When is the right time to implement them?

- You are beginning an energy savings initiative
- You notice a spike in utility bills
- You need demand and consumption measured
- You have meters implemented currently and are looking for a sub-metering option
- You want to monitor individual processes and subprocesses

METERING LEVELS	PowerMonitor 500	PowerMonitor 1000 ¹	PowerMonitor 5000
Energy (Consumption)(kWh)	X	X	X
Demand (kW)	X	X	X
Power factor	X	X	X
Power quality aspects (sag/swell detection, harmonics, and transients)			X
Waveform capture			X
Door-mounted display	X	Optional	Optional
Ethernet/IP Network Communication	X	X	X
Configurable by using webpage		X	X
Accuracy levels (per standard EN62053-22)			
Class 1, 1% energy accuracy	X	X	
Class 0.2, 0.2% energy accuracy			X

¹ The PowerMonitor 1000 unit has an LCD display option and can be used with any Rockwell Automation operator interface.

Relays & Timers



2-2...2-19

Programmable Controllers



2-20...2-23

Control Circuit & Load Protection



2-24...2-35

Power Supplies



2-36...2-43

Power Quality & Energy Management



2-44...2-45

Surge & Filter



2-46...2-49



Product Selection

PowerMonitor 500

Type	Communication Network	Cat. No.
PowerMonitor 500 V1	Serial power meter	1420-V1-485
	Serial power meter, analog output	1420-V1A-485
	Serial power meter, pulse (digital) output	1420-V1P-485
	EtherNet/IP power meter	1420-V1-ENT
	EtherNet/IP power meter, analog output	1420-V1A-ENT
	EtherNet/IP power meter, pulse (digital) output	1420-V1P-ENT
PowerMonitor 500 V2	Serial power meter	1420-V2-485
	Serial power meter, analog output	1420-V2A-485
	Serial power meter, pulse (digital) output	1420-V2P-485
	EtherNet/IP power meter	1420-V2-ENT
	EtherNet/IP power meter, analog output	1420-V2A-ENT
	EtherNet/IP power meter, pulse (digital) output	1420-V2P-ENT

PowerMonitor 1000

Type	Communication Network	Cat. No.
PowerMonitor 1000 BC3	Basic consumption meter w/serial	1408-BC3A-485
	Basic consumption meter w/Ethernet	1408-BC3A-ENT
PowerMonitor 1000 TS3	Consumption + Volt/Current w/serial	1408-TS3A-485
	Consumption + Volt/Current w/Ethernet	1408-TS3A-ENT
PowerMonitor 1000 EM3	Energy management meter w/serial	1408-EM3A-485
	Energy management meter w/Ethernet	1408-EM3A-ENT

PowerMonitor 5000

Type	Communication Network	Cat. No.
PowerMonitor 5000 M5	Basic Power Quality w/Ethernet	1426-M5E
	Ethernet and optional ControlNet	1426-M5E-CNT
	Ethernet and optional DeviceNet	1426-M5E-DNT
PowerMonitor 5000 M6	Power Quality w/Ethernet	1426-M6E
	Ethernet and optional ControlNet	1426-M6E-CNT
	Ethernet and optional DeviceNet	1426-M6E-DNT
PowerMonitor 5000 M8	Advanced Power Quality w/Ethernet	1426-M8E
	Ethernet and optional ControlNet	1426-M8E-CNT
	Ethernet and optional DeviceNet	1426-M8E-DNT

Specifications

PowerMonitor 500

Parameter	Accuracy in % of Reading at 25 °C 50/60 Hz Unity Power Factor	Nominal/Range
Voltage sense inputs: V1	±0.5%	Line-neutral rms: 120 V nominal, 40...144V Line-line rms: 208 V nominal, 70...250V
Voltage sense inputs: V2		Line-neutral rms: 400 V nominal, 160...480V Line-line rms: 600 V nominal, 277...830V
Current	±0.5%	5A nominal, 0.01...6 A rms
Real Energy	Class 1 according to EN62053-21, ANSI C12.1 Class B according to EN50470-3	-
Reactive Energy	Class 1 according to EN62053-23, ANSI C12.1	-

PowerMonitor 1000

Parameter	Accuracy in % of Reading at 25 °C 50/60 Hz Unity Power Factor	Nominal/Range
Voltage sense inputs: V1, V2, V3	±0.5%	Line-neutral rms: 347V nominal, 15...399V Line-line rms: 600V nominal, 26...691V
Current sense	±0.5%	5 A rms
Power functions: kW, kVA, kVAR Demand functions: kW, kVA, kVAR Energy functions: kWH, kVAH, kVARH	EN62053-21:2003 Accuracy Requirement Class 1	-

PowerMonitor 5000

Parameter	Accuracy in % of Reading at 25 °C 50/60 Hz Unity Power Factor	Nominal/Range
Voltage sense inputs: V1, V2, V3, VN	±0.1%	Line-neutral rms: 398V nominal, 15...660V Line-line rms: 690V nominal, 26...1144V
Current sense input: I1, I2, I3, I4	±0.1%	5A nominal, 0.05...15.6 A rms
Power functions: kW, kVA, kVAR Demand functions: kW, kVA, kVAR Energy functions: kWH, kVAH, kVARH	ANSI C12.20 -2010 Class 0.2 EN 62053-22 -2003 Class 0.2 accuracy	-



Surge & Filter

LOGIC

DIN Rail AC Power Surge Protector 4983-DS

- Compact modular design
- Visual fault indicator linked to internal thermal disconnect
- A controlled end-life occurrence will trigger SPD replacement indicator
- Equipped standard with safety remote signaling AC network connection



Application Information

Brief voltage spikes and surges can be caused by a wide range of factors originating from both within and outside of a production facility. Whatever their source, these transients can damage electronic equipment, requiring expensive replacement and production delays.

Bulletin 4983-DS surge protectors use metal oxide varistor (MOV) technology. Unlike most MOV-based surge protection, these devices are larger, replaceable and designed for DIN Rail mounting in an electrical environment.

The MOV technology is a high impedance component (high resistance device) When a surge occurs, the MOV changes to a low impedance (resistance) device and diverts surges away from the load and directs it to ground. MOVs have high energy capability and consistent clamping performance.

Because MOV-based surge protectors are sacrificial – they break down every time they divert surges away from a load – 4983-DS protectors can be replaced after an event. Many electronic components have some form of built-in protection and are not user-replaceable.

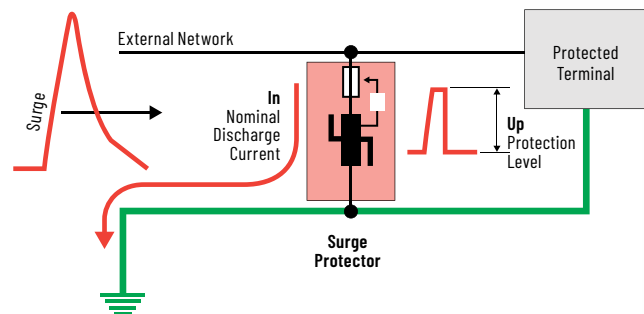

2-46

Relays & Timers



2-2...2-19

Programmable Controllers



2-20...2-23

Control Circuit & Load Protection



2-24...2-35

Power Supplies



2-36...2-43

Power Quality & Energy Management



2-44...2-45

Surge & Filter



2-46...2-49

Product Selection

AC Network	Connection Mode	No. of Poles	Max. Continuous Operating Voltage (MCOV) (U _c) [V AC]	Max. Discharge Current 8/20 ms (I _{max}) [kA]	Protection Level (Up) [kV]	UL 1449 Voltage Protection Rating (VPR) [V]	Cat. No. Base and Module			
120	L/G or N/G	1	150	40	0.9	700	4983-DS120-401			
	L/G, N/G	2					4983-DS120-402			
120/208Y	L1/G, L2/G, L3/G	3					4983-DS120-403			
	L1/G, L2/G, L3/G, N/G	4					4983-DS120-404			
230/400	L/G or N/G	1					275	1.25	1000	4983-DS230-401
	L/G, N/G	2								4983-DS230-402
	L1/G, L2/G, N/G	3	4983-DS230-403							
277	L/G or N/G	1	420		1.8	1500	4983-DS277-401			
277/480Y	L1/G, L2/G, L3/G	3					4983-DS277-403			
	L1/G, L2/G, L3/G, N/G	4					4983-DS277-404			
480D	L1/G, L2/G, L3/G	3					550	1.8	1800	4983-DS480-403
230/400	L/G, N/G	2	275		1.25	1000	4983-DS230-401G			
	L1/G, L2/G, L3/G, N/G	4		1000		4983-DS230-403G				
120	L/G or N/G	1	150	80	0.9	700	4983-DS120-801			
120/208Y	L/G, N/G	2					4983-DS120-802			
	L1/G, L2/G, L3/G	3					4983-DS120-803			
230/400	L/G or N/G	1	275		1.25	1000	4983-DS230-801			
	L/G, N/G	2					4983-DS230-802			
	L1/G, L2/G, N/G	3					4983-DS230-803			
277	L/G or N/G	1	420		1.8	1500	4983-DS277-801			
277/480Y	L1/G, L2/G, L3/G	3					4983-DS277-803			
	L1/G, L2/G, L3/G, N/G	4					4983-DS277-804			
480D	L1/G, L2/G, L3/G	4					680	2500	2500	4983-DS277-804
600D	L1/G, L2/G, L3/G	4	690		4983-DS600-804					

Specifications

Connection/mounting type	Parallel/DIN Rail mount
Certifications	cURus, CSA, CE Marked
Conductor material	Cu, solid, or stranded
Conductor range	#10...4 AWG (4...28 mm ²)
Strip length	0.4 in. (10 mm)
Tightening torque	17.8...22.1 lb•in. (2.0...2.5 N•m)
No. of conductors/terminal	1
Operating temperature	-40...+80 °C



Product Certifications

Global certifications available online:

<https://rok.auto/certifications>



Surge & Filter

Filter Protective Devices 4983-PF

- Filter for low-level transients and high-frequency noise
- UL 1283, CSA, CE
- Features Islatrol® filter technology
- LED power indication
- Panel (flange) mount



4983-PF

4983-DC

- UL 1449 Third Edition, UL 1283, CE
- Small combination (filter and SPD) package size
- Features Islatrol filter technology
- LED power indication
- Form C contact for remote status indication



4983-DC

Bulletin 4983-PF and 4983-DC filter protective devices address low-level voltage transients and high-frequency noise disturbances that, over time, cause premature aging. The long term effects of noise are just as damaging as high voltage transients. The 4983-PF and 4983-DC devices feature Islatrol filter technology. Islatrol filter technology continually tracks and monitors the input signal to provide clean and reliable AC power for critical equipment.

Bulletin 4983-PF and 4983-DC filters are connected in series. Protection is best when the devices are installed directly in front of the load requiring protection. Typical applications include any microprocessor based products such as PLCs, motion control systems, and computers exposed to harsh environments.



Relays & Timers



2-2...2-19

Programmable Controllers



2-20...2-23

Control Circuit & Load Protection



2-24...2-35

Power Supplies



2-36...2-43

Power Quality & Energy Management



2-44...2-45

Surge & Filter



2-46...2-49

Product Selection

Operating Voltage [V AC]	Max. Continuous Operating Voltage [V AC]	Line Frequency [Hz]	Ampacity [A]	4983-PF	4983-DC
				Cat. No.	Cat. No.
120	150	47...63	2.5	4983-PF120-02	-
			3	-	4983-DC120-03
			5	4983-PF120-05	4983-DC120-05
			10	-	4983-DC120-10
			15	4983-PF120-15	-
			20	-	4983-DC120-20
			30	4983-PF120-30	-
240	275		2.5	4983-PF240-02	-
	320		3	-	4983-DC240-03
	275		5	4983-PF240-05	-
	320		5	-	4983-DC240-05
	320		10	-	4983-DC240-10
	275		15	4983-PF240-15	-
	320		20	-	4983-DC240-20
	275	30	4983-PF240-30	-	

Specifications

	4983-PF	4983-DC
Connection/Mounting Type	Series/panel (flange) mount	Series/DIN Rail mount
Enclosure	Grey, high-impact plastic	Metal
Modes of Protection	Line - Neutral	
	Line - Line	
	Line - PE	
	Neutral - PE	
Certifications	UR Recognized component, CE Marked	UR Recognized, CSA, CE Marked
Typical Cat. A Ringwave Rating	< 10V peak	< 60V peak
Typical Cat. B Ringwave Rating	< 50V peak	< 100V peak
Response Time	Normal mode: < 0.5 ns	
	Common mode: < 5 ns	
Operating Temperature	-40...+60 °C derate linearly to 60% @ +70 °C	
Fusing	Appropriate external fusing is required	
Frequency Response (Forward - Reverse) 100 kHz...50 MHz	Normal mode - 90 dB min.	Normal mode (100 kHz...50 MHz) - 90 dB min.
	Common mode - 60 dB min.	Common mode (5...50 MHz) - 60 dB min.
	3 kHz cut-off frequency	50 kHz cut-off frequency



Additional Logic Products



Control Circuit Transformers 1497

- Designed to reduce supply voltages to control circuits, providing greater safety to operators
- P2X finger-safe terminal covers and fuse covers
- 1497 global control transformers 63...2000 VA (50, 60 and 50/60 Hz)
- 1497A machine tool transformers 50...3000 VA (50/60 Hz)
- 1497B control power transformers 50...3000 VA (60 Hz)
- 1497D general purpose transformers 0.050...25.0 kVA (60 and 50/60 Hz)

i-Sense/i-Grid Intelligent Network 1608S

The i-Sense® voltage event monitor is ideal for analyzing the feed into your facility with limited investment. Voltage quality data is viewed on the i-Grid® cloud-based application, which means that there is no software to install or maintain. Instant event e-mail and text notifications will keep power quality data at your fingertips.



DySC Voltage Sag Correctors 1608

DySC® voltage sag correctors protect against voltage sags and momentary outages that account for a significant amount of manufacturing downtime and damaged equipment.

- Single- and three-phase portfolio
- Up to five seconds of ride-through
- 1608N Mini DySC (0.25...14 kVA)
- 1608P Pro DySC (10...165 kVA)
- 1608M Mega DySC (333...2000 kVA)

Relays & Timers



2-2...2-19

Programmable Controllers



2-20...2-23

Control Circuit & Load Protection



2-24...2-35

Power Supplies



2-36...2-43

Power Quality & Energy Management



2-44...2-45

Surge & Filter



2-46...2-49

Push Buttons

22 mm Push Buttons, Pilot Lights, and Selector Switches	3-2
22 mm Emergency Stop Operators	3-8
22 mm Monolithic Push Buttons, Pilot Lights, and Selector Switches.....	3-10
30 mm Push Buttons, Pilot Lights, Selector Switches, and Push-Pulls	3-12
30 mm Emergency Stop Operators	3-18
Piezoelectric Push Buttons	3-20
16 mm Push Buttons, Pilot Lights, Selector Switches, and E-Stops	3-22

Signaling*

Panel Mount Alarms.....	3-24
Control Tower Stack Lights	3-26
Wall Mount Signal Lights.....	3-30
Industrial Horns.....	3-32
Industrial Beacons	3-34

Graphic Terminals

PanelView 800 Graphic Terminals.....	3-36
--------------------------------------	------

Additional Operator Interface Products 3-38

***IMPORTANT** These products are intended for use in industrial signaling applications only.

Push Buttons

22 mm Push Buttons, Pilot Lights, and Selector Switches 800F

- 800FP plastic operators
 - IP65/66/69k, Type 4/4X/13
 - Engineering grade thermoplastics
 - Chemical-resistant for harsh environments
- 800FM metal operators
 - IP65/66, Type 4/13
 - Die-cast metal construction
 - Chrome-plated



800F Push Buttons

- Momentary or alternate action
- Illuminated or non-illuminated
- Flush or extended
- 2-color legend caps
- Multi-operators

800F Pilot Lights

- LED and incandescent
- Multiple voltages
- 24V, 120V, 240V
- 6 color options

800F Selector Switches

- 2-, 3-, and 4-position
- Illuminated or non-illuminated
- Maintained or spring return
- Key selector switches



Dependable Sealing

- IP66 and Type 4/13
- Superior ingress protection
- Diaphragm seals

Selection Switches feature Positive Detent

- No hang-up between positions
 - Constant energy solution
 - Vibration insensitive



Rotating Latch Collar

- Easier installation
- One-hand removal
- Plastic or metal



Push Buttons



3-2...3-23

Signaling



3-24...3-35

Graphic Terminals



3-36...3-37

Product Selection

800F – Momentary and Maintained Push Button Operators – Flush, Extended, Guarded, Alternate Action, Non-Illuminated, Illuminated



Type	Button Color	Text Color	Legend Text	Flush	Extended	Guarded	Alternate Action
				Cat. No.	Cat. No.	Cat. No.	Cat. No.
Non-Illuminated	● Orange	-	-	800F⊗-F0	800F⊗-E0	800F⊗-G0	800F⊗-FA0
	○ White	-	-	800F⊗-F1	800F⊗-E1	800F⊗-G1	800F⊗-FA1
	● Black	-	-	800F⊗-F2	800F⊗-E2	800F⊗-G2	800F⊗-FA2
	● Black	White	→	800F⊗-F208	800F⊗-E208	800F⊗-G208	-
	● Green	-	-	800F⊗-F3	800F⊗-E3	800F⊗-G3	800F⊗-FA3
	● Green	White	START	800F⊗-F301	-	800F⊗-G301	-
	● Green	White		800F⊗-F306	-	800F⊗-G306	-
	● Red	-	-	800F⊗-F4	800F⊗-E4	800F⊗-G4	800F⊗-FA4
	● Red	White	STOP	800F⊗-F402	800F⊗-E402	800F⊗-G402	-
	● Red	White	○	800F⊗-F405	800F⊗-E405	800F⊗-G405	-
	● Yellow	-	-	800F⊗-F5	800F⊗-E5	800F⊗-G5	800F⊗-FA5
	● Blue	-	-	800F⊗-F6	800F⊗-E6	800F⊗-G6	800F⊗-FA6
	● Blue	White	R	800F⊗-F611	800F⊗-E611	800F⊗-G611	-
	● Grey	-	-	800F⊗-F8	-	-	-
	○ No Cap	-	-	800F⊗-F9	800F⊗-E9	800F⊗-G9	800F⊗-FA9
Illuminated	● Amber	-	-	800F⊗-LF0	800F⊗-LE0	800F⊗-LG0	800F⊗-LFA0
	● Green	-	-	800F⊗-LF3	800F⊗-LE3	800F⊗-LG3	800F⊗-LFA3
	● Red	-	-	800F⊗-LF4	800F⊗-LE4	800F⊗-LG4	800F⊗-LFA4
	● Yellow	-	-	800F⊗-LF5	800F⊗-LE5	800F⊗-LG5	800F⊗-LFA5
	● Blue	-	-	800F⊗-LF6	800F⊗-LE6	800F⊗-LG6	800F⊗-LFA6
	○ Clear	-	-	800F⊗-LF7	800F⊗-LE7	800F⊗-LG7	800F⊗-LFA7
	○ No Cap	-	-	800F⊗-LF9	800F⊗-LE9	800F⊗-LG9	800F⊗-LFA9

⊗ To complete the catalog number, replace the ⊗ with one of the following letters: **P** – Plastic operator, or **M** – Metal operator.

Pilot Light Operators

Color	Plastic	Metal
	Cat. No.	Cat. No.
● Amber	800FP-P0	800FM-P0
● Green	800FP-P3	800FM-P3
● Red	800FP-P4	800FM-P4
● Yellow	800FP-P5	800FM-P5
● Blue	800FP-P6	800FM-P6
○ Clear	800FP-P7	800FM-P7
○ No Cap	800FP-P9	800FM-P9



Specifications

Material	Plastic	Glass-filled Polyamide
	Metal	Chromated Zinc
Degree of Protection	Plastic	IP65/66 (Type 3/3R/4/4X/12/13)
	Metal	IP65/66 (Type 3/3R/4/12/13)
Operational Temperature Range		-25...+70 C (-13...+158F)
Certifications		UR/UL, CSA, CCC, CE
Standards Compliance		NEMA ICS-5; UL 508; EN ISO 13850; EN 60947-1; EN 60947-5-1; EN 60947-5-5

For more information on our complete family of 22 mm push button products, please visit:
<https://rok.auto/22mm-push-buttons>



Push Buttons

Product Selection

Selector Switch Operators –
Non-illuminated, Illuminated, Key-operated



Type	Knob Color	# of Positions	Knob Type or Keyed	Plastic	Metal
				Cat. No.	Cat. No.
Non-Illuminated	● Black	2	Standard	800FP-S⊗2	800FM-S⊗2
	● Black	2	Knob Lever	800FP-H⊗2	800FM-H⊗2
	● Black	3	Standard	800FP-S⊗3	800FM-S⊗3
	● Black	3	Knob Lever	800FP-H⊗3	800FM-H⊗3
	● Black	4	Standard	800FP-SM4	800FM-SM4
	● Black	4	Knob Lever	800FP-HM4	800FM-HM4
	● Black	2	Keyed	800FP-K⊗2◆	800FM-K⊗2◆
	● Black	3	Keyed	800FP-K⊗3⊠	800FM-K⊗3⊠
Illuminated	● Amber	2	Standard	800FP-LS⊗20	800FM-LS⊗20
	● Green	2	Standard	800FP-LS⊗23	800FM-LS⊗23
	● Red	2	Standard	800FP-LS⊗24	800FM-LS⊗24
	● Yellow	2	Standard	800FP-LS⊗25	800FM-LS⊗25
	● Blue	2	Standard	800FP-LS⊗26	800FM-LS⊗26
	○ Clear	2	Standard	800FP-LS⊗27	800FM-LS⊗27
	○ Clear	2	Knob Lever	800FP-LH⊗27	800FM-LH⊗27
	● Amber	3	Standard	800FP-LS⊗30	800FM-LS⊗30
	● Green	3	Standard	800FP-LS⊗33	800FM-LS⊗33
	● Red	3	Standard	800FP-LS⊗34	800FM-LS⊗34
	● Yellow	3	Standard	800FP-LS⊗35	800FM-LS⊗35
	● Blue	3	Standard	800FP-LS⊗36	800FM-LS⊗36
	○ Clear	3	Standard	800FP-LS⊗37	800FM-LS⊗37
	○ Clear	3	Knob Lever	800FP-LH⊗37	800FM-LH⊗37

⊗ - add **M**- Maintained, **R**-spring return from **Right**, **L**-spring return from **Left**.

⊗ - add **M**- Maintained, **R**-spring return from **Right**, **L**-spring return from **Left**, **B**-spring return from **Both**.

◆ - add **1**-key removal in **Left**, **2**-key removal in **Right**, **3**-key removal in **All**.

⊠ - add **1**-key removal in **Left**, **2**-key removal in **Right**, **3**-key removal in **All**, **4**-key removal in **center**, **5**-key removal in **Left and Center**, **7**-key removal in **Center and Right**.

Push Buttons



3-2...3-23

Signaling



3-24...3-35

Graphic Terminals



3-36...3-37

Product Selection



2-Position Push-Pull Operators

Color	Non-Illuminated		Illuminated			
	40 mm Cap	90 mm Half Dome	30 mm Cap	40 mm Cap	60 mm Cap	90 mm Half Dome
	Cat. No.	Cat. No.	Cat. No.	Cat. No.	Cat. No.	Cat. No.
● Black	800F⊗-MP42	800F⊗-MP92	-	-	-	-
● Green	800F⊗-MP43	-	800F⊗-LMP33	800F⊗-LMP43	800F⊗-LMP63	-
● Red	800F⊗-MP44	800F⊗-MP94	800F⊗-LMP34	800F⊗-LMP44	800F⊗-LMP64	800F⊗-LMP94
● Yellow	800F⊗-MP45	800F⊗-MP95	800F⊗-LMP35	800F⊗-LMP45	800F⊗-LMP65	800F⊗-LMP95
● Blue	800F⊗-MP46	-	800F⊗-LMP36	800F⊗-LMP46	800F⊗-LMP66	-

⊗ - To complete the catalog number, replace the ⊗ with one of the following letters: P - Plastic operator, or M - Metal operator.



Momentary Mushroom Operators

Color	Non-Illuminated			Illuminated
	40 mm Cap	60 mm Cap	90 mm Cap	40 mm Cap
	Cat. No.	Cat. No.	Cat. No.	Cat. No.
● Black	800F⊕-MM42	800F⊕-MM62	800F⊕-MM92	-
● Green	800F⊕-MM43	800F⊕-MM63	-	800F⊕-LMM43
● Red	800F⊕-MM44	800F⊕-MM64	800F⊕-MM94	800F⊕-LMM44
● Yellow	800F⊕-MM45	800F⊕-MM65	800F⊕-MM95	800F⊕-LMM45
● Blue	800F⊕-MM46	800F⊕-MM66	-	800F⊕-LMM46
○ Clear	-	-	-	800F⊕-LMM47

⊕ - To complete the catalog number, replace the ⊕ with one of the following letters: P - Plastic operator, or M - Metal operator.



3-Position Push-Pull Operator

Type	Color	Function	Cat. No.	Function	Cat. No.
Non-Illuminated	● Black	Out - Momentary Center - Maintained In-Momentary	800FM-MM42E3	Out - Momentary Center - Maintained In-Maintained	800FM-MP42E3
	● Green		800FM-MM43E3		800FM-MP43E3
	● Red		800FM-MM44E3		800FM-MP44E3
Illuminated	● Amber		800FM-LMM40E3		800FM-LMP40E3
	● Green		800FM-LMM43E3		800FM-LMP43E3
	● Red		800FM-LMM44E3		800FM-LMP44E3
	● Blue		800FM-LMM46E3		800FM-LMP46E3
	○ Clear	800FM-LMM47E3	800FM-LMP47E3		

For more information on our complete family of 22 mm push button products, please visit:
<https://rok.auto/22mm-push-buttons>



Push Buttons

Product Selection

Multi-Function Operators –
2-Function, 3-Function, Non-Illuminated, Illuminated



Top Cap			Bottom Cap				Non-Illuminated		Illuminated
Color	Type	Graphic	Color	Type	Graphic	2-Function	3-Function	2-Function	
						Cat. No.	Cat. No.	Cat. No.	
● Green	Flush		● Red	Extended	○	800F⊕-U2EFFE	800F⊕-U3EFFE4	800F⊕-LU2EFFE	
● Green	Flush	-	● Red	Extended	-	800F⊕-U2E4F3	800F⊕-U3E4F34	800F⊕-LU2E4F3	
● Green	Flush	-	● Green	Flush	-	800F⊕-U2F3F3	800F⊕-U3F3F34	800F⊕-LU2F3F3	
○ White	Flush		● Black	Extended	○	800F⊕-U2EHFG	800F⊕-U3EHFG4	800F⊕-LU2EHFG	
○ White	Flush	-	● Black	Flush	-	800F⊕-U2F2F1	800F⊕-U3F2F14	800F⊕-LU2F2F1	
● Black	Flush	-	● Black	Flush	-	800F⊕-U2F2F2	800F⊕-U3F2F24	800F⊕-LU2F2F2	
○ White	Flush	-	○ White	Flush	-	800F⊕-U2F1F1	800F⊕-U3F1F14	800F⊕-LU2F1F1	

⊕ - To complete the catalog number, replace the ⊕ with one of the following letters: P – Plastic operator, or M – Metal operator.

Potentiometer – Single Turn



Resistive Element	Cat. No.
None	800FP-POT
150 Ω	800FP-POT1
500 Ω	800FP-POT2
1000 Ω	800FP-POT3
2500 Ω	800FP-POT4
5000 Ω	800FP-POT5
10000 Ω	800FP-POT6

Toggle Switch Operators – Mechanical and/or Electrical Reset



Positions	Function	Cat. No.
— 2	Maintained	800FM-JM2
	Momentary	800FM-JR2
+ 4	Maintained	800FM-JM4
	Momentary	800FM-JR4

Selector Push Button



Positions	Cap Color	Cat. No.
2	● Black	800F⊗-SJ22
	● Green	800F⊗-SJ23
3	● Black	800F⊗-SJ32
	● Green	800F⊗-SJ33

⊗ To complete the catalog number, replace the ⊗ with one of the following letters: P – Plastic operator, or M – Metal operator.

Reset Operators – Mechanical and/or Electrical Reset



Button Color	Text Color	Legend Text	Flush	
			Plastic	Metal
			Cat. No.	Cat. No.
● Blue	White	R	800FP-R611	800FM-R611
● Blue	-	-	800FP-R6	800FM-R6

Push Buttons



3-2...3-23

Signaling



3-24...3-35

Graphic Terminals



3-36...3-37

Product Selection



Mounting Latches

Material	Cat. No.
Plastic	800F-ALP
Metal	800F-ALM



Contact Blocks

Contact Type - Screw Termination	Cat. No.
N.O. - Normally Open	800F-X10
N.C. - Normally Closed	800F-X01
N.C. - Self-Monitoring	800F-X01S
N.O. Low Voltage - add voltage	800F-X10V
N.C. Low Voltage - add voltage	800V-X01V
Dual circuit - 2 N.O.	800F-X20D
Dual circuit - 2 N.C.	800F-X02D
Dual circuit - 1 N.O./1 N.C.	800F-X11D
N.O.E.M. - Early Make	800F-X10E
N.O.L.M. - Late Make	800F-X10N
N.C.E.B. - Early Break	800F-X01B
N.C.L.B - Late Break	800F-X01L



LED Power Modules

Color	Volts	Cat. No.
● Green	24V AC/DC	800F-N3G
● Red		800F-N3R
○ White		800F-N3W
● Green	120V AC	800F-N5G
● Red		800F-N5R
○ White		800F-N5W
● Green	240V AC	800F-N7G
● Red		800F-N7R
○ White		800F-N7W

Legend Plates



Type	Available Colors	Text / Symbol	Cat. No.
30 x 40 mm 2-piece Snap-in Plate and Frame	○ White	Blank	800F-11☒E100
	● Black	START	800F-11☒E208
	● Red	STOP	800F-11☒E212
	● Aluminum	- ○	800F-11☒U232
30 x 50 mm 2-piece Snap-in Plate and Frame	○ White	Blank	800F-12◆E100
	● Black	HAND-OFF-AUTO	800F-12◆E128
	● Aluminum	ON-OFF	800F-12◆E165
30 x 40 mm 1-piece	○ White	-	800F-34☒E100
	● Black		
30 x 50 mm 1-piece	● Red	-	800F-35☒E100
	● Aluminum		

☒ To complete the catalog number, replace the ☒ with one of the following letters for the desired color: **W** = White, **B** = Black, **A** = Aluminum or **R** = Red.

◆ To complete the catalog number, replace the ◆ with one of the following letters for the desired color: **W** = White, **B** = Black, **A** = Aluminum.



Enclosures

Holes	Gray Plastic	Yellow Plastic	Metal
1	800F-1P☒	800F-1Y☒ 800F-1Y☒D ¹	800F-1M☒
2	800F-2P☒	-	800F-2M☒
3	800F-3P☒	-	800F-3M☒
4	800F-4P☒	-	-
5	-	-	800F-5M☒
6	800F-6P☒	-	-

☒ To complete the catalog number, replace the ☒ with one of the following letters for through holes: **M** = metric knock out, **P** = PG knock out.

¹ Dual circuit contact blocks allowed.



Push Buttons

22 mm Emergency Stop Operators 800F/800FD

- Trigger action
- 30, 40, 60, and 90 mm operating heads
- Complies with EN ISO 13850 and EN 60947-5-5
- Self-monitoring contact blocks for increased safety
- Global certifications



Rockwell Automation® safety products and solutions improve the functional operation of your machinery while helping to increase personnel safety, efficiency and productivity. 800F 22 mm E-stops offer a wide variety of devices to meet individual customer application requirements.

Self-Monitoring Contact Blocks (SMCB)



- Opens controlled circuit in unlikely event contact block is separated from operator
- Monitors proper installation between:
 - Operator and latch
 - Latch and SMCB

800F Enclosed E-stops for SensaGuard, GuardLink or Series Wiring

The pre-wired 800F E-stop push button stations allow for quick installation with the 5- and 8-pin SensaGuard™ and GuardLink family of non-contact safety switches. The 5-pin stations can also be wired in series with each other for easy conveyor or long run installation.



- 24V AC/DC
- Pre-tested and factory sealed for time savings on wiring and set-up
- Illuminated when activated for ease and speed of identification
- Maintains SensaGuard PLe, Cat 4, SIL 3 rating
- Flexibility for use in non-SensaGuard and GuardLink applications

To learn more about GuardLink technology and its benefits, see page 5-2



For additional emergency stop devices, see page 5-48



Push Buttons



3-2...3-23

Signaling



3-24...3-35

Graphic Terminals



3-36...3-37

Product Selection

E-Stop Twist-To-Release, Push-Pull Operators –
Non-Illuminated, Illuminated, Keyed



Color	Size [mm]	Twist-to-Release			
		Non-Illuminated		Illuminated	
		Plastic	Metal	Plastic	Metal
		Cat. No.	Cat. No.	Cat. No.	Cat. No.
Red	30	800FP-MT34	800FM-MT34	-	-
	40	800FP-MT44	800FM-MT44	800FP-LMT44	800FM-LMT44
	60	800FP-MT64	800FM-MT64	800FP-LMT64	800FM-LMT64
	40 Keyed	800FP-MK44	800FM-MK44	-	-
Color	Size [mm]	Push-Pull			
		Non-Illuminated		Illuminated	
		Plastic	Metal	Plastic	Metal
		Cat. No.	Cat. No.	Cat. No.	Cat. No.
Red	30	-	-	800FP-LMP34	800FM-LMP34
	40	800FP-MP44	800FM-MP44	800FP-LMP44	800FM-LMP44
	60	-	-	800FP-LMP64	800FM-LMP64
	90	800FP-MP94	800FM-MP94	800FP-LMP94	800FM-LMP94

Assembled E-Stop Stations –
Unwired, Series Wiring,
SensaGuard and GuardLink



Description	Contact Type	Pins	SensaGuard/ GuardLink	Series Wiring	Cat. No.
Unwired	1 N.C.	-	-	-	800F-1YM1
Unwired	1 N.C./1 N.O.	-	-	-	800F-1YM2
Unwired	2 N.C.	-	-	-	800F-1YM3
End Station	2 N.C./1 N.O. 24V DC Illuminated	5	-	X	800F-1YMD51
T-Port Station		5	X	X	800F-1YMD52
Safety Distribution Block		8	X	-	800F-1YMD81

Monolithic
Twist-to-Release/Push-Pull



Color	Size [mm]	Pkg. Qty.	Contact Type	Plastic Cat. No.
Red	40	1	1 N.C.	800FD-MT44X01
			2 N.C.	800FD-MT44X02

Accessories

Mounting Latches

Description	Cat. No.
Metal	800F-ALM
Plastic	800F-ALP

Contact Blocks

Contact Type	Cat. No.
N.O.	800F-X10
N.C.	800F-X01
Self-monitoring	800F-X01S

Legend Plate

Description	Cat. No.
EMERGENCY STOP	800F-15YSE112
Blank	800F-15YS



Push Buttons

22 mm Monolithic Push Buttons, Pilot Lights, and Selector Switches 800FD

- Single-piece construction with integrated contact block
- Cost-effective design
- Low back-of-panel profile (45.7 mm)
- IP66, Type 3/3R/4/4X/12/13



800FD monolithic push buttons feature a self-contained design that combines the contact block and operator for ease of ordering, stocking, and installation.

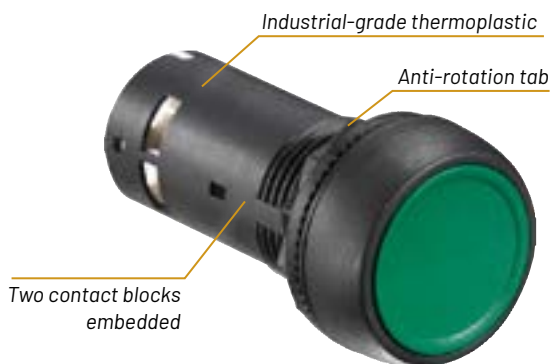

Push Button Operator

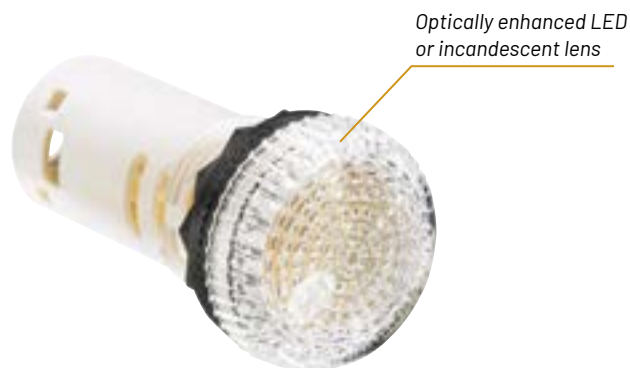

Pilot Light Device

Products

- Non-illuminated
 - Momentary push button
 - 2-position push-pull/twist-to-release E-stop
 - 2-position selector switch
 - 3-position selector switch
- Illuminated
 - Pilot light, LED
 - Pilot light, incandescent

Pilot Light Devices

Color		LED		
		24V AC/DC	120V AC	240V AC
		Cat. No.	Cat. No.	Cat. No.
● Amber		800FD-P0N3	800FD-P0N5	800FD-P0N7
● Green		800FD-P3N3	800FD-P3N5	800FD-P3N7
● Red		800FD-P4N3	800FD-P4N5	800FD-P4N7
● Yellow		800FD-P5N3	800FD-P5N5	800FD-P5N7
● Blue		800FD-P6N3	800FD-P6N5	800FD-P6N7
○ Clear		800FD-P7N3	800FD-P7N5	800FD-P7N7

Push Buttons



3-2...3-23

Signaling



3-24...3-35

Graphic Terminals



3-36...3-37





Product Selection

Momentary Push Button Operators – Flush, Extended, Non-illuminated

Type	Button Color	Text Color	Legend Text	Contact Block Configuration				
				1 N.O.	1 N.C.	1 N.O. & 1 N.C.	2 N.O.	
				Cat. No.	Cat. No.	Cat. No.	Cat. No.	
Flush	○	White	-	-	800FD-F1X10	800FD-F1X01	800FD-F1X11	800FD-F1X20
	●	Black	-	-	800FD-F2X10	800FD-F2X01	800FD-F2X11	800FD-F2X20
	●	Black	White	→	800FD-F208X10	800FD-F208X01	800FD-F208X11	800FD-F208X20
	●	Green	-	-	800FD-F3X10	800FD-F3X01	800FD-F3X11	800FD-F3X20
	●	Green	White	START	800FD-F301X10	800FD-F301X01	800FD-F301X11	800FD-F301X20
	●	Green	White		800FD-F306X10	800FD-F306X01	800FD-F306X11	800FD-F306X20
	●	Red	-	-	800FD-F4X10	800FD-F4X01	800FD-F4X11	800FD-F4X20
	●	Yellow	-	-	800FD-F5X10	800FD-F5X01	800FD-F5X11	800FD-F5X20
	●	Blue	-	-	800FD-F6X10	800FD-F6X01	800FD-F6X11	800FD-F6X20
Extended	○	White	-	-	800FD-E1X10	800FD-E1X01	800FD-E1X11	800FD-E1X20
	●	Black	-	-	800FD-E2X10	800FD-E2X01	800FD-E2X11	800FD-E2X20
	●	Black	White	→	800FD-E208X10	800FD-E208X01	800FD-E208X11	800FD-E208X20
	●	Green	-	-	800FD-E3X10	800FD-E3X01	800FD-E3X11	800FD-E3X20
	●	Red	-	-	800FD-E4X10	800FD-E4X01	800FD-E4X11	800FD-E4X20
	●	Red	White	STOP	800FD-E402X10	800FD-E402X01	800FD-E402X11	800FD-E402X20
	●	Red	White	○	800FD-E405X10	800FD-E405X01	800FD-E405X11	800FD-E405X20
	●	Yellow	-	-	800FD-E5X10	800FD-E5X01	800FD-E5X11	800FD-E5X20
	●	Blue	-	-	800FD-E6X10	800FD-E6X01	800FD-E6X11	800FD-E6X20
●	Blue	White	R	800FD-E611X10	800FD-E611X01	800FD-E611X11	800FD-E611X20	

Selector Switches – Non-illuminated

# of Positions	Contact Block Type	Contact Block Location	Contact Type	Target Table			Cat. No.
							
2	1 N.C.	Left	N.C.	X	NA	0	800FD-S⊗2X01
		Right	-	-	NA	-	
2	1 N.O.	Left	-	-	NA	-	800FD-S⊗2X10
		Right	N.O.	0	NA	X	
2	1 N.O. & 1 N.C.	Left	N.C.	X	NA	0	800FD-S⊗2X11
		Right	N.O.	0	NA	X	
2	2 N.C.	Left	N.C.	X	NA	0	800FD-S⊗2X02
		Right	N.C.	X	NA	0	
2	2 N.O.	Left	N.O.	0	NA	X	800FD-S⊗2X20
		Right	N.O.	0	NA	X	
3	1 N.O. & 1 N.C.	Left	N.C.	0	X	X	800FD-S⊕3X11
		Right	N.O.	0	0	X	
3	2 N.C.	Left	N.C.	0	X	X	800FD-S⊕3X02
		Right	N.C.	X	X	0	
3	2 N.O.	Left	N.O.	X	0	0	800FD-S⊕3X20
		Right	N.O.	0	0	X	



⊗ - add **M**- Maintained, **R**-spring return from **Right**, **L**-spring return from **Left**

⊕ - add **M**- Maintained, **R**-spring return from **Right**, **L**-spring return from **Left**, **B**-spring return from **Both**

For more information on our complete family of 22 mm push button products, please visit:
<https://rok.auto/22mm-push-buttons>



Push Buttons

30 mm Push Buttons, Pilot Lights, Selector Switches, and Push-Pulls 800T/H

- Heavy industrial stations and operators
- Type 4/13 watertight/oiltight (800T)
- Type 4/4X/13 watertight/corrosion-resistant/oiltight (800H)
- Universal LED for long life, simplified product selection and reduced energy usage
- Class I, Div. 2 solutions available



Imitated, But Never Duplicated

800T and 800H push button product lines are in a class by themselves. They are designed and constructed to perform in the most demanding industrial environments. Bold yet functional, rugged yet attractive, Allen-Bradley® push buttons represent the world's most innovative and unique offering.

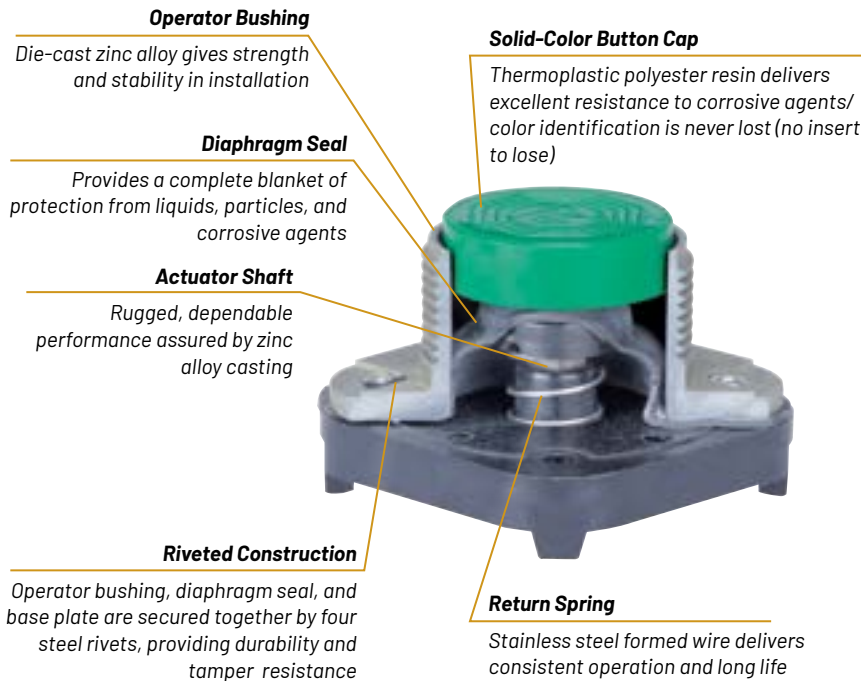

Explosion-Protected Contact Block

- Class I Div. 2 certified
- Ideal for high shock and vibration applications
- 1 N.O., 1 N.C., A600-rated
- Positive opening N.C. contact



Push Buttons



3-2...3-23

Signaling



3-24...3-35

Graphic Terminals



3-36...3-37

Product Selection

Momentary Contact Push Button Units – Non-Illuminated



Contact Type	Button Color	Type 4/13		Type 4/4X/13	
		Flush Head	Extended Head	Booted ¹	Bootless Flush Head
		Cat. No.	Cat. No.	Cat. No.	Cat. No.
No Contact	● Green	800T-A1	800T-B1	800H-R1	800H-AR1
	● Black	800T-A2	800T-B2	800H-R2	800H-AR2
	● Red	800T-A6	800T-B6	800H-R6	800H-AR6
1 N.O.	● Green	800T-A1D1	800T-B1D1	800H-R1D1	800H-AR1D1
	● Black	800T-A2D1	800T-B2D1	800H-R2D1	800H-AR2D1
	● Red	800T-A6D1	800T-B6D1	800H-R6D1	800H-AR6D1
1 N.C.	● Green	800T-A1D2	800T-B1D2	800H-R1D2	800H-AR1D2
	● Black	800T-A2D2	800T-B2D2	800H-R2D2	800H-AR2D2
	● Red	800T-A6D2	800T-B6D2	800H-R6D2	800H-AR6D2
1 N.O. – 1 N.C.	● Green	800T-A1A	800T-B1A	800H-R1A	800H-AR1A
	● Black	800T-A2A	800T-B2A	800H-R2A	800H-AR2A
	● Red	800T-A6A	800T-B6A	800H-R6A	800H-AR6A

¹ Underlying operators are extended head. Boot material is chlorosulfonated polyethylene.



Momentary Contact Push Button Units – Illuminated, LED

Type	Voltage	Color	Type 4/13		Type 4/4X/13	
			Extended Head without Guard ²	Extended Head with Guard ²	Extended Head without Guard ²	Extended Head with Guard ²
			Cat. No.	Cat. No.	Cat. No.	Cat. No.
Universal	12...130V AC/DC	● Red	800T-QBH2R	800T-QAH2R	800H-QRBH2R	800H-QRAH2R
		● Green	800T-QBH2G	800T-QAH2G	800H-QRBH2G	800H-QRAH2G
		● Amber	800T-QBH2A	800T-QAH2A	800H-QRBH2A	800H-QRAH2A

² Includes as standard one catalog number 800T-XA (1 N.O. – 1 N.C.) contact block.



Need Help?

The Rockwell Automation Support Center is your 24/7 support for the answers you need now.
<https://rok.auto/support>



For more information on our complete family of 30 mm push button products, please visit:
<https://rok.auto/30mm-push-buttons>

Push Buttons

Product Selection



Selector Switch Units – 2-Position, Non-Illuminated

Contact Type	Operator Position		M = Maintained S = Spring Return	Type 4/13		Type 4/4X/13	Type 4/13		
				Standard Knob	Knob Lever	Standard Knob	Cylinder Lock		
							Key Removal (Left) ²	Key Removal (Right) ²	Key Removal (Both) ²
				Cat. No.	Cat. No.	Cat. No.	Cat. No.	Cat. No.	Cat. No.
No contacts	-	-	M M	800T-H2	800T-H17	800H-HR2	800T-H31	800T-H32	800T-H33
			S→M	800T-H4	800T-H18	800H-HR4	-	-	-
			M←S	800T-H5	800T-H19	800H-HR5	800T-H48	-	-
1 N.O.	0	X	M M	800T-H2D1	800T-H17D1	800H-HR2D1	800T-H31D1	800T-H32D1	800T-H33D1
			S→M ¹	800T-H4D1	800T-H18D1	800H-HR4D1	-	800T-H42D1	-
			M←S	800T-H5D1	800T-H19D1	800H-HR5D1	800T-H48D1	-	-
1 N.O. 1 N.C.	0 X	X 0	M M	800T-H2A	800T-H17A	800H-HR2A	800T-H31A	800T-H32A	800T-H33A
			S→M ¹	800T-H4A	800T-H18A	800H-HR4A	-	800T-H42A	-
			M←S	800T-H5A	800T-H19A	800H-HR5A	800T-H48A	-	-

¹ Target tables are reversed from those shown.

² Keys removable from maintained positions only.



Selector Switch Units – 3-Position, Non-Illuminated

Contact Type	Operator Position			M = Maintained S = Spring Return	Type 4/13		Type 4/4X/13	Type 4/13		
					Standard Knob	Knob Lever	Standard Knob	Cylinder Lock		
								Key Removal (Left) ²	Key Removal (Right) ²	Key Removal (All) ²
					Cat. No.	Cat. No.	Cat. No.	Cat. No.	Cat. No.	Cat. No.
No contacts	-	-	-	M M M	800T-J2	800T-J17	800H-JR2	800T-J41	800T-J42	800T-J44
				S→M M	800T-J4	800T-J18	800H-JR4	-	800T-J50	-
				M M←S	800T-J5	800T-J19	800H-JR5	800T-J69	800T-J38	-
				S→M←S	800T-J91	800T-J20	800H-JR91	-	800T-J631	-
1 N.O. 1 N.C.	0 X	0 0	X 0	M M M	800T-J2A	800T-J17A	800H-JR2A	800T-J41A	800T-J42A	800T-J44A
				S→M M	800T-J4A	800T-J18A	800H-JR4A	-	800T-J50A	-
				M M←S	800T-J5A	800T-J19A	800H-JR5A	800T-J69A	800T-J38A	-
				S→M←S	800T-J91A	800T-J20A	800H-JR91A	-	800T-J631A	-

¹ Target tables are reversed from those shown.

² Keys removable from maintained positions only.

Push Buttons



3-2...3-23

Signaling



3-24...3-35

Graphic Terminals



3-36...3-37

Product Selection

Pilot Light Units – LED





Contact Type	Volts	Color	Type 4/13		Type 4/4X/13	
			Pilot Light	Push-to-Test ¹	Pilot Light	Push-to-Test ¹
			Cat. No.	Cat. No.	Cat. No.	Cat. No.
Universal	12...130V AC/DC	● Red	800T-QH2R	800T-QTH2R	800H-QRH2R	800H-QRTH2R
		● Green	800T-QH2G	800T-QTH2G	800H-QRH2G	800H-QRTH2G
		● Amber	800T-QH2A	800T-QTH2A	800H-QRH2A	800H-QRTH2A

¹ Includes one standard catalog number 800T-XA (1 N.O. - 1 N.C.) contact block.





2-Position Push-Pull and Push-Pull/Twist Release Units – Non-Illuminated

Contact Type	Operator Position		Type 4/13		Type 4/4X/13
			Push-Pull	Push-Pull/ Twist Release	Push-Pull/ Twist Release
	Out	In	Cat. No.	Cat. No.	Cat. No.
N.C.L.B	X	0	800T-FX6D4	800T-FXT6D4	800H-FRXT6D4
N.O. N.C.L.B	0 X	X 0	800T-FX6A1	800T-FXT6A1	800H-FRXT6A1
N.C.L.B N.C.L.B	X X	0 0	800T-FX6A5	800T-FXT6A5	800H-FRXT6A5
S.M.C.B.	X	0	800TC-FX6D4S	800TC-FXT6D4S	800HC-FRXT6D4S
N.O. S.M.C.B.	0 X	X 0	800TC-FX6A1S	800TC-FXT6A1S	800HC-FRXT6A1S
S.M.C.B S.M.C.B	X X	0 0	800TC-FX6A5S	800TC-FXT6A5S	800HC-FRXT6A5S



2-Position Push-Pull and Push-Pull/Twist Release Units – Illuminated, LED

Contact Type	Volts	Contacts	Operator Position		Type 4/13		Type 4/4X/13
					Push-Pull	Push-Pull/ Twist Release	Push-Pull/ Twist Release
			Out	In	Cat. No.	Cat. No.	Cat. No.
Universal	12...130V AC/DC	N.O. N.C.L.B	0 X	X 0	800T-FXQH2RA1	800T-FXTQH2RA1	800H-FRXTQH2RA1



Push Buttons

Product Selection



Enclosures

	Die Cast ^{1,2} (Type 4/13)	Stainless Steel ¹ (Type 4/4X/13)	Glass-Filled Polyester (Type 4/4X/13)	Fiberglass ³ (Type 4/4X/13)	Thermoplastic Polyester ⁴ (Type 4/4X)
Operator Openings	Cat. No.	Cat. No.	Cat. No.	Cat. No.	Cat. No.
1	800T-1TZ	800H-1HZ4	800H-1HZ4R	800H-1HZ4Y	800H-1HZ4C
2	800T-2TZ	800H-2HZ4	800H-2HZ4R	800H-2HZ4Y	800H-2HZ4C
3	800T-3TZ	800H-3HZ4	800H-3HZ4R	800H-3HZ4Y	800H-3HZ4C
4	800T-4TZ	800H-4HZ4	800H-4HZ4R	-	800H-4HZ4C
6	800T-6TZ	800H-6HZ4	800H-6HZ4R	-	-

¹ Bottom conduit entry. Grounding screw provided.

² Enclosure depth will accommodate one shallow and one mini-contact block stacked.

³ Extra deep - accommodates two levels of explosion-protected contact blocks.

⁴ No conduit openings provided.



Contact Blocks

Contact Type	Shallow Block ⁵	Mini Block ⁵	PenTUFF (Low Voltage) Block ⁵	Explosion-Protected Block ⁶	Self-Monitoring Contact Block	Max Duty Block
	Cat. No.	Cat. No.	Cat. No.	Cat. No.	Cat. No.	Cat. No.
1 N.O.	800T-XD1	800T-XD5	800T-XDIV	-	-	800T-XD1M
1 N.C.	800T-XD2	800T-XD6	800T-XD2V	-	-	800T-XD2M
1 N.O.E.M.	800T-XD3	-	800T-XD3V	-	-	-
1 N.C.L.B.	800T-XD4	-	800T-XD4V	-	-	800T-XD4M
1 N.O. - 1 N.C.	800T-XA	-	800T-XAV	800TC-XAF	-	-
2 N.O.	800T-XA2	-	-	-	-	-
2 N.C.	800T-XA4	-	-	-	-	-
1 N.C.L.B. - 1 N.O.	800T-XA1	-	-	-	-	-
1 N.C.L.B. - 1 N.C.	800T-XA7	-	-	-	-	-
1 N.C.L.B. (wired in series with 1 N.O. monitoring contact)	-	-	-	-	800TC-XD4S	-

⁵ Contact blocks with normally closed contacts meet direct drive positive opening standard requirements when properly fused to IEC 269-1 and 269-2. Shallow/mini contacts: 10 A gl or N type cartridge fuse. PenTUFF contacts: 6 A gl or N type cartridge fuse.

⁶ 800T operators using explosion protected, sealed switch or logic reed contact blocks and installed in a suitable enclosure are UL Listed as suitable for use in Class I, Division 2 hazardous locations.

Push Buttons



3-2...3-23

Signaling



3-24...3-35

Graphic Terminals



3-36...3-37

Product Selection

Blank and Custom Legend Plates



Type	Start/Stop Legend Plates	Emergency Stop Legend Plates		
	Grey	Yellow	Yellow (Large Size)	Yellow IEC Ring
	Cat. No.	Cat. No.	Cat. No.	Cat. No.
Blank	-	-	800T-X645Y	800T-X646
Custom	-	-	800T-X645YE	-
Emergency Stop	-	-	-	800T-X646EM
Push-to-Stop Pull-to-Start or Push-to-Stop Twist or Pull Release	800T-X618	800T-X618Y	800T-X647Y	-

Standard Legends



Marking	Aluminum, Type 4/13	Grey Plastic, Type 4/4X	Marking	Aluminum, Type 4/13	Grey Plastic, Type 4/4X	Marking	Aluminum, Type 4/13	Grey Plastic, Type 4/4X
	Cat. No.	Cat. No.		Cat. No.	Cat. No.		Cat. No.	Cat. No.
AUTO-MAN-OFF	800T-X625	800H-W059	JOG	800T-X517	800H-W110	RUN	800T-X540	800H-W123
AUTO-OFF-HAND	800T-X501	800H-W154	JOG FORWARD	800T-X518	800H-W111	RUN-JOG	800T-X541	800H-W032
CLOSE	800T-X502	800H-W101	JOG REVERSE	800T-X519	800H-W112	SAFE-RUN	800T-X542	800H-W033
DOWN	800T-X503	800H-W102	JOG RUN	800T-X520	800H-W135	SLOW	800T-X544	800H-W125
EMERG. STOP (Red) ¹	800T-X504	800H-W372	JOG-STOP-RUN	800T-X521	800H-W057	SLOW-FAST	800T-X545	800H-W136
EMERG. STOP (Yellow)	800T-X504Y	-	LOW	800T-X524	800H-W113	SLOW-OFF-FAST	800T-X546	800H-W157
EMERGENCY STOP (Red) ¹	800T-X648	800H-W373	OFF	800T-X527	800H-W116	SPEED ²	800T-X608	800H-W081
FAST	800T-X505	800H-W104	OFF-ON	800T-X529	800H-W133	START	800T-X547	800H-W126
FOR.-OFF-REV.	800T-X507	800H-W152	ON	800T-X530	800H-W117	START-JOG	800T-X548	800H-W138
FOR.-REV.	800T-X506	800H-W132	ON-OFF	800T-X622	-	START-STOP	800T-X549	800H-W137
FORWARD	800T-X508	800H-W105	OPEN	800T-X531	800H-W118	STOP (Red)	800T-X550	800H-W371
HAND-AUTO	800T-X510	800H-W131	OPEN-CLOSE	800T-X532	800H-W134	STOP-START	800T-X551	800H-W038
HAND-OFF-AUTO	800T-X511	800H-W151	OPEN-OFF-CLOSE	800T-X533	800H-W153	TEST	800T-X554	800H-W128
HIGH	800T-X512	800H-W107	POWER ON	800T-X639	800H-W001	UP	800T-X556	800H-W009
HIGH-LOW	800T-X513	800H-W030	RESET	800T-X538	800H-W121	UP-DOWN	800T-X557	800H-W039
HIGH-OFF-LOW	800T-X514	800H-W058	REVERSE	800T-X539	800H-W122	UP-OFF-DOWN	800T-X558	800H-W160

¹ These legend plates do not comply with E-Stop standards that specify a yellow background, such as IEC 60947-5-5 and NFPA 79.

² Potentiometer type with graduated markings.



Push Buttons

30 mm Emergency Stop Operators 800T/H

- Trigger action
- Certified UL Category NISD and NNTD Emergency Stop Devices
- Complies with EN ISO 13850 and EN 60947-5-5
- Tamper-resistant front-of-panel mounting
- Non-removable mushroom cap
- Non-teasible with standard normally closed (N.C.) contacts



State-of-the-art, Tamper-resistant Design

Trigger action functionality provided in the 800T/H trigger action E-stop delivers operators that meet global requirements and are ideal for installation in heavy duty applications. The twist release design conforms to functional safety guidelines where intentional action is required to reset the E-stop device.

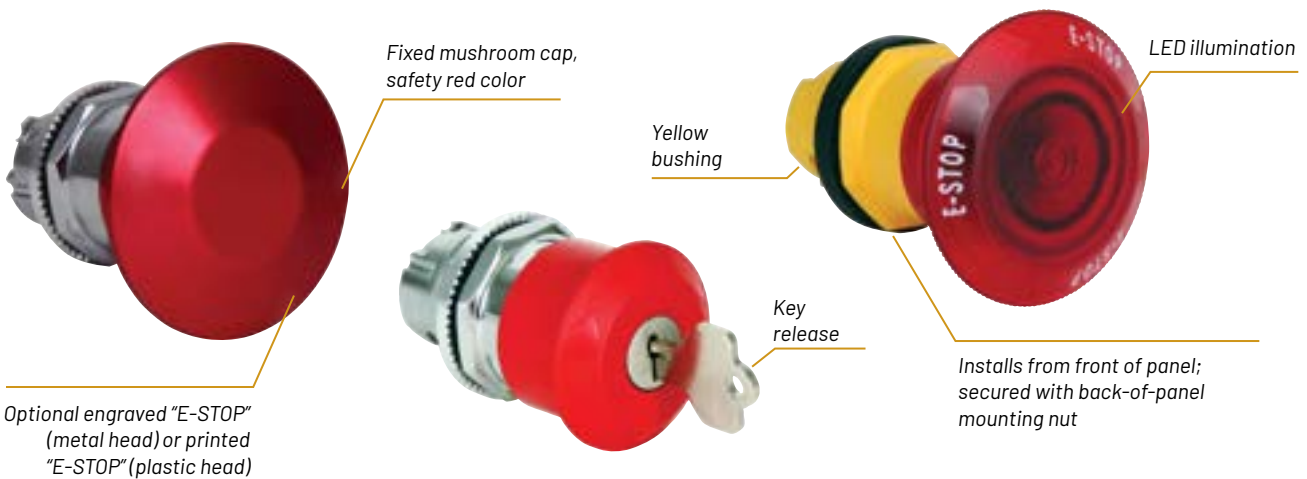

Self-Monitoring Contact Block



- Opens controlled circuit in the unlikely event the contact block becomes separated from the operator
- 10 A max., A600 rated
- Bifurcated spanner with pure fine silver contacts
- Color-coded yellow for easy identification
- IP2X finger-safe protection standard

Push Buttons



3-2...3-23

Signaling



3-24...3-35

Graphic Terminals



3-36...3-37

Product Selection

2-Position Red Trigger Action Twist-to-Release – Non-Illuminated



Contact Type	Operator Position		Type 4/13			Type 4/4X/13
			45 mm Plastic	63 mm Metal	Key Release	45 mm Plastic
	Out	In	Cat. No. ^{1,2,3}	Cat. No. ^{1,4}	Cat. No. ¹	Cat. No. ^{1,2,3}
No contacts	-	-	800T-TFXT6	800T-TFXLT6	800T-TFXK6	800H-TFRXT6
1 N.C.	X	0	800T-TFXT6D2	800T-TFXLT6D2	800T-TFXK6D2	800H-TFRXT6D2
1 N.O. - 1 N.C.	0 X	X 0	800T-TFXT6A	800T-TFXLT6A	800T-TFXK6A	800H-TFRXT6A
1 S.M.C.B. ⁵	X	0	800TC-TFXT6D4S	800TC-TFXLT6D4S	800TC-TFXK6D4S	800HC-TFRXT6D4S
2 N.C.	X X	0 0	800T-TFXT6A4	800T-TFXLT6A4	800T-TFXK6A4	800H-TFRXT6A4
2 S.M.C.B.	X X	0 0	800TC-TFXT6A5S	800TC-TFXLT6A5S	800TC-TFXK6A5S	800HC-TFRXT6A5S

- ¹ For finger-safe contact block terminals, add a **C** to the catalog number Example: Catalog number 800**TC**-TFXT6 or 800**HC**-TFRXT6.
² To order a device with a jumbo (60 mm) plastic head add the letter **J** after X. Example: Catalog number 800T-TFX**J**T6A or 800H-TFRX**J**T6A.
³ To order a jumbo head device with "E-STOP" printed on the cap add the letters **JE** after X. Example: Catalog number 800T-TFX**JE**T6 or 800H-TFRX**JE**T6.
⁴ To order a device with "E-STOP" engraved on the cap add the letter **E** after L. Example: Catalog number 800TC-TFX**LE**T6D4S.
⁵ Self-monitoring contact block.



2-Position Red Trigger Action Twist-to-Release – Illuminated

Type	Voltage	Contact Type	Operator Position		Type 4/13			Type 4/4X/13
					45 mm	60 mm	45 mm	60 mm
			Out	In	Cat. No. ⁶	Cat. No. ^{6,7}	Cat. No. ⁶	Cat. No. ^{6,7}
Operator only ⁸		No contacts		800T-TFXTS00R	800T-TFXJTS00R	800H-TFRXTS00R	800H-TFRXJTS00R	
Universal	12...130V AC/DC	N.O. - N.C.	0 X	X 0	800T-TFXTQH2RA	800T-TFXJTOH2RA	800H-TFRXTQH2RA 800H-TFRXJTOH2RA	

- ⁶ For finger-safe contact block terminals, add a **C** to the catalog number Example: Catalog number 800**TC**-TFXTS00R or 800**HC**-TFRXTS00R.
⁷ To order a device with "E-STOP" printed on the cap add the letter **E** after J. Example: Catalog number 800T-TFX**JE**TQH2RA or 800H-TFRX**JE**TQH2RA.
⁸ Operator-only supplied without power module, lamp, or contact blocks.

Accessories

30 mm push button accessories start on page 3-16.



Safety

Our innovative safety products and solutions improve the functional operation of your machinery while helping to increase personnel safety, efficiency and productivity.

<https://rok.auto/safety-products>



Push Buttons

Piezoelectric Push Buttons 800K

- IP69K rating
- 22.5 mm and 30.5 mm
- 316 stainless-steel
- Smooth, crevice-free surface
- Custom engraving (text and symbols) available



The 800K Piezoelectric push buttons represent an innovative rethinking of push button technology and its industrial applications. The potted piezoelectric circuit detects pressure on the surface of the button to provide a momentary actuation signal with no moving parts. These push buttons are ideal for food, beverage and other industries where high-pressure, caustic washdowns can challenge even the most robust push buttons.

Smooth, Crevice-free Surface

- Easier to clean
- Minimizes areas on the button in which contaminants can potentially be lodged



Illumination

Red, green, white, blue or yellow

316 Stainless-steel

Corrosion resistant to caustic wash-down solutions



Potted Circuit

- Helps prevent fluids from corroding operator components
- Provides an additional barrier of protection

No Moving Parts

By using piezoelectric technology, moving seals and crevices can be eliminated from the push button

Mounting Ring

Nickel-plated Brass



Anti-rotation Washer

316 Stainless Steel



Push Buttons



3-2...3-23

Signaling



3-24...3-35

Graphic Terminals



3-36...3-37



Product Selection

Momentary Push Button Operators – Screw Termination, 24VDC

Hole Size		Color	Contact Type	Engraving	Cat. No.	
22.5 mm		Non-Illuminated	N.O.	Blank	800K-22FMN24X10	
	●	Green	N.O.		800K-22FMG24X10	
	●	Red	N.C.		800K-22FMR24X01	
	○	White	N.O.		800K-22FMW24X10	
	●	Blue	N.O.		800K-22FMB24X10	
	●	Yellow	N.O.		800K-22FMY24X10	
		Non-Illuminated	N.O.		800K-22FMN24X10⊗	
	●	Green	N.O.	800K-22FMG24X10⊗		
	●	Red	N.C.	800K-22FMR24X01⊗		
	○	White	N.O.	800K-22FMW24X10⊗		
	●	Blue	N.O.	800K-22FMB24X10⊗		
	●	Yellow	N.O.	800K-22FMY24X10⊗		
	30.5 mm		Non-Illuminated	N.O.	Blank	800K-30FMN24X10
		●	Green	N.O.		800K-30FMG24X10
●		Red	N.C.	800K-30FMR24X01		
○		White	N.O.	800K-30FMW24X10		
●		Blue	N.O.	800K-30FMB24X10		
●		Yellow	N.O.	800K-30FMY24X10		
		Non-Illuminated	N.O.	800K-30FMN24X10⊕		
●		Green	N.O.	800K-30FMG24X10⊕		
●		Red	N.C.	800K-30FMR24X01⊕		
○		White	N.O.	800K-30FMW24X10⊕		
●		Blue	N.O.	800K-30FMB24X10⊕		
●		Yellow	N.O.	800K-30FMY24X10⊕		

⊗ - Add custom text Font Code **E100G** (12 pt), **E100H** (16 pt), **E100J** (20 pt) or custom symbol code **U100**.

⊕ - Add custom text codes **E100H** (16 pt), **E100J** (20 pt) or custom symbol code **U100**.

Custom Text Lines / Character Chart

Font Code	No. of Lines	Characters per Line			
		22.5 mm		30.5 mm	
		Non-Illuminated	Illuminated	Non-Illuminated	Illuminated
E100G (12 pt)	1	8	6	-	-
	2	8/8	5...6/5...6	-	-
	3	7/8/7	4/6/4	-	-
E100H (16 pt)	1	6...7	5	9	6...7
	2	6/6	4/4	8/8	6/6
	3	4/6/4	-	7/9/7	4/6/4
E100J (20 pt)	1	5	1...4	7	5
	2	5/5	-	6...7/6...7	5/5
	3	-	-	6/7/6	-

For more information on our complete family of specialty push button products, please visit: <https://rok.auto/specialty-push-buttons>



Push Buttons

16 mm Push Buttons, Pilot Lights, Selector Switches, and E-Stops 800B

- Ergonomic design
- Designed to global standards
- IP66 and Type 4/13
- Excellent for panels with limited space
- Illuminated and non-illuminated
- Trigger action E-stop



800B 16 mm push buttons can meet your light industrial and instrumentation application needs with their highly configurable and flexible design. These operators are excellent for applications with limited panel space or a small footprint. They are made of corrosion-proof plastic to ensure long push button life.

Ease of Installation

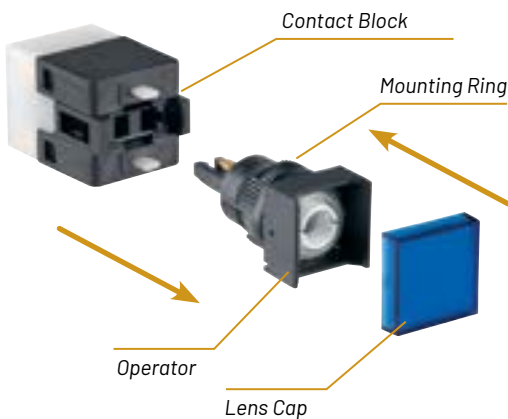

Push Buttons & Pilot Lights

- Momentary or maintained options
- Bright, bold, consistent operators (green, red, yellow, blue, white)
- Contoured button surface for comfort
- Diaphragm seals

Selector Switches

- 2 or 3 position
- V seal - High pressure sealing
- Gold-plated snap action contacts

E-stop

- Anti-tease feature
- Trigger-action design
- K seal - Dual wiping action

Push Buttons



3-2...3-23

Signaling



3-24...3-35

Graphic Terminals



3-36...3-37

Product Selection



Push Button & Pilot Light Operators

Operator Type	Round	Square	Rectangle	Large Square
	Cat. No.	Cat. No.	Cat. No.	Cat. No.
Momentary, push button/pilot light	800B-EPA	800B-EPB	800B-EPC	800B-EPD
Maintained, push button	800B-EAA	800B-EAB	800B-EAC	800B-EAD

Note: All operators are sold without a lens cap and diffuser.

Lens Cap with Diffuser



Lens Color	Round	Square	Rectangle	Large Square
	Cat. No.	Cat. No.	Cat. No.	Cat. No.
Green	800B-ALA3	800B-ALB3	800B-ALC3	800B-ALD3
Red	800B-ALA4	800B-ALB4	800B-ALC4	800B-ALD4
Yellow	800B-ALA5	800B-ALB5	800B-ALC5	800B-ALD5
Blue	800B-ALA6	800B-ALB6	800B-ALC6	800B-ALD6
White	800B-ALA7	800B-ALB7	800B-ALC7	800B-ALD7

Selector Switch Operators



Operator Type	Maintained	Return from Right	Keyed, Maintained	Keyed, Return from Right
	Cat. No.	Cat. No.	Cat. No.	Cat. No.
2-position	800B-SM2A	800B-SR2A	800B-KM2A	800B-KR2A
Operator Type	Maintained	Return from Both	Keyed, Maintained	Keyed, Return from Both
	Cat. No.	Cat. No.	Cat. No.	Cat. No.
3-position	800B-SM3A	800B-SB3A	800B-KM3A	800B-KB3A

Emergency Stop Operator

Operator Type	Cat. No.
Emergency stop operator	800B-MT



Illumination



Description	Lamp Color	Lamp Voltage	Cat. No.
LED bulb ¹	Green	12...24V AC/DC	800B-N3G
		120V AC	800B-N5G
	Red	12...24V AC/DC	800B-N3R
		120V AC	800B-N5R
	White	12...24V AC/DC	800B-N3W
		120V AC	800B-N5W
Incandescent bulb ²	Clear	6V AC/DC	800B-N1C
		12V AC/DC	800B-N2C
		24V AC/DC	800B-N3C

¹ Not available in 6V AC/DC.

² Not available in 120V AC.



Contact Block/Latch Module

Description	Cat. No.
Push Button/Selector Switch	
1 N.O./1 N.C. snap action	800B-PS11
2 N.O./2 N.C. snap action	800B-PS22
Pilot Light	
Dummy block	800B-PL
Emergency Stop/Push Button/Selector Switch	
1 N.C. slow make/break	800B-PT01
2 N.C. slow make/break	800B-PT02
1 N.O./1 N.C. slow make/break	800B-PT11

Sales Offices and Distributors

Our network of sales offices and distributors offers exceptional knowledge and service to help you design, implement and support your automation investment.

<https://rok.auto/buy>



Signaling

Panel Mount Alarms 855P

- Visual, audible, or combined indication
- Completely enclosed front, suitable for harsh washdown environments
- Ingress protection rating UL Type 4/4X/13, IP65
- Rear-securing and finger-safe terminals
- Mount in a standard 22.5 mm hole or 30.5 mm hole with adapter



855P panel mount alarms allow local indication of the status of a machine or equipment while enhancing space efficiency with devices ready to be installed in a control panel. These devices include features that preserve the control panel integrity and reduce installation time. Alarm options include sounders, status indicator beacons, xenon strobes, and sounders with status indicator combination, as well as dual-circuit alarms.

Bulletin 855PB LED Beacon

Mounting ring to secure device to the rear of the panel



855P Sounders

Removable plug-in terminal block
Keyed to avoid wiring mistakes



855PC Combined Sounder w/ LED beacon

Completely enclosed front tamper/vandal resistant suitable for wash down environments



Bulletin 855PS Xenon Strobe Beacon

Voltage color coding for easy identification of the circuit



2-Color Half-Lens (with barrier)

Signal up to two different conditions on a machine with only one device



Push Buttons



3-2...3-23

Signaling



3-24...3-35

Graphic Terminals



3-36...3-37

Product Selection

855P Panel Mount Sounders

Voltage	Size [mm]	Cat. No.
12...24V AC/DC	30 (72 dB)	855P-B30SE22
	30 (80 dB)	855P-B30SH22
	45	855P-B30ME22
120V AC	65	855P-B30LE22
	30 (72 dB)	855P-B10SE22
	30 (80 dB)	855P-B10SH22
120V AC	45	855P-B10ME22
	65	855P-B10LE22

Accessories

Description	Cat. No.
22.5...30.5 mm hole adapter kit	855P-AHA1

Specifications

Housing Material	Base	Polycarbonate (black)
	Lens	Polycarbonate (red, amber, yellow, green, blue, and clear)
Environmental Ratings	UL Type 4/4X/13, IP65	
Operation Temperature Range	-25...+60 °C (-13...+140 °F)	
Mounting	Central mounting for bore holes 22 mm or 30.5 mm with hole adapter kit (Cat. No. 855P-AHA1)	
Certifications	cULus Listed, CE Marked	



Need Help?

The Rockwell Automation Support Center is your 24/7 support for the answers you need now.

<https://rok.auto/support>

855PS Panel Mount Strobes and 855PB Selectable Steady or Flashing LED Beacons

Voltage	Diameter [mm]	Lens Color	Panel Mount Strobe	Selectable Steady/Flashing LED Beacon
			Cat. No.	Cat. No.
24V AC/DC	30	Green	855PS-B24SE322	855PB-B24SE322
		Red	855PS-B24SE422	855PB-B24SE422
	45	Green	855PS-B30ME322	855PB-B24ME322
		Red	855PS-B30ME422	855PB-B24ME422
	65	Green	855PS-B30LE322	855PB-B24LE322
		Red	855PS-B30LE422	855PB-B24LE422
120V AC	30	Green	855PS-B10SE322	855PB-B10SE322
		Red	855PS-B10SE422	855PB-B10SE422
	45	Green	855PS-B10ME322	855PB-B10ME322
		Red	855PS-B10ME422	855PB-B10ME422
	65	Green	855PS-B10LE322	855PB-B10LE322
		Red	855PS-B10LE422	855PB-B10LE422

855PC Combined Sounders with LED Beacon and 855PD Dual-Circuit Alarms

Function	Voltage	Diameter [mm]	Color(s)	Combined Sounder with LED Beacon	Dual Circuit Alarm
				Cat. No.	Cat. No.
Sounder with LED	24V AC/DC	45	Green	855PC-B24ME322	855PD-B24MEC1322
			Red	855PC-B24ME422	855PD-B24MEC1422
		65	Green	855PC-B24LE322	855PD-B24LEC1322
			Red	855PC-B24LE422	855PD-B24LEC1422
	120V AC	45	Green	855PC-B10ME322	855PD-B10MEC1322
			Red	855PC-B10ME422	855PD-B10MEC1422
65		Green	855PC-B10LE322	855PD-B10LEC1322	
		Red	855PC-B10LE422	855PD-B10LEC1422	
Half-lens, steady LED beacon ¹	24V AC/DC	30	Red & Green	-	855PD-B24SEH4322
		45		-	855PD-B24MEH4322
		65		-	855PD-B24LEH4322
	120V AC	45	Red & Green	-	855PD-B10MEH4322
65		-		855PD-B10LEH4322	

¹ Full lens style with 2 LED beacons also available.



Signaling

Control Tower™ Stack Lights 854J (40 mm) & 854K (60 mm)

- Suitable for indoor and outdoor use
- IP66 rated housing
- Expandable to five levels per stack or up to ten modules in a single arrangement via the double-sided base option
- Piezoelectric sound modules maintain the ingress rating when mounted in the stack



The Control Tower stack lights are designed to communicate status of different conditions alerting you to critical equipment and systems needs on plant floor. Available in a wide variety of light and sound functions, sizes, colors, voltages and mounting options, our stack lights help monitor some of your most challenging control panel and on-machine applications.

Lens Colors Options

		
3 = Green	4 = Red	5 = Amber
		
6 = Blue	7 = Clear	8 = Yellow



Five circuits maximum in one stack



854K (60 mm)

Piezo Sound Module

Light Modules

- LED or incandescent
- Multiple color options

Terminal Block mounted on top of the base for easy wiring

Mounting Options

- Pole
- Quick release
- Surface
- Tube
- Vertical
- Double-sided base
- Half-inch NPT base
- Surface mount with M12-5 pin connector



854J (40 mm)

Tool-free lens assembly

Up to ten circuits maximum on double sided base

Push Buttons



3-2...3-23

Signaling



3-24...3-35

Graphic Terminals



3-36...3-37

Product Selection

Pre-configured Devices

Voltage	Mounting Base	Level 1		Level 2		Level 3		Piezo Sound Module	40 mm	60 mm
		LED Module	Color	LED Module	Color	LED Module	Color		Cat. No.	Cat. No.
24V AC/DC	10 cm pole mount	Steady	Red	-	-	-	-	-	854JC-P10B24Y4	854KC-P10B24Y4
	10 cm pole mount	-	-	-	-	-	-	Yes	854JC-P10B24P1	854KC-P10B24P1
	10 cm pole mount	Steady	Blue	Steady	Green	Steady	Red	-	854JC-P10B24Y6Y3Y4	854KC-P10B24Y6Y3Y4
	1/2 in. NPT thread	Steady	Green	Steady	Red	Steady	Amber	-	854JC-NPTB24Y3Y4Y5	854KC-NPTB24Y3Y4Y5

Accessories

Description	For use with 854J	For use with 854K
	Cat. No.	Cat. No.
10 cm plastic base extension, black	854J-ABBE	854K-ABBE
Plastic vertical bracket for pole foot, black	854J-ABPB	854J-ABPB
O-rings for lenses	854J-ALSG ¹	854K-ALSG ¹
O-rings for bases	854J-ABSG ¹	-
Gasket for SH surface mount bases	854J-ASG2 ¹	854K-ASG2 ¹
Upper base with terminal block, black	854J-ABUB	854K-ABUB
Cap, black	854J-ABCAP	854K-ABCAP
Conduit mount adapter for threaded tube base (1/2 in. NPT to M20x1.5)	854J-ACMK	854J-ACMK
L-bracket for threaded tube base (vertical mount kit)	854J-ABVM	854J-ABVM
Direct mount kit for threaded tube base	854J-ARDM	854J-ARDM

¹ Order quantity of 1 to receive package of 5.

Specifications

Housing Material	Modules (lenses, caps, bases)	Polycarbonate
	Seals and gaskets	Nitrile rubber
	Pole and base	Aluminum pole with polycarbonate base
	Mounting screw washers	Polypropylene
Environmental Ratings		UL Type 4/4X/13, IP66
Operating Temperature Range		-25...+60 °C (-13...+140 °F)
Mounting		Surface mount base, vertical base, aluminum pole base dual sided base, quick release base, threaded tube, or NPT conduit mounting for indoor and outdoor use
Flash Frequency		Flashing Modules: 1.5 Hz (Time On/Time Off = 1:1) Strobe Modules: 2 Hz (flash duration 1/50,000 second)
Sound Module dB Rating		Max. 80 dB (non-adjustable) at 1m from sound module for 854J or Max. 90 dB (adjustable) at 1m from sound module for 854K
Certifications		cULus Listed, CE Marked, RoHS Compliant



Configure the Control Tower Stack Lights to meet your application needs through Product Selection:

<https://rok.auto/854-stack-lights>



Looking for More?

This catalog highlights only our most essential components; for a complete product selection, visit us at:
<https://rok.auto/directory>



Signaling

Control Tower™ Stack Lights 856T

- Up to 7 modules in a single stack
- Outstanding brightness with low power consumption
- Light modules with multi-function capabilities available in seven colors
- Choice of piezoelectric, transducer and recordable sound modules to complement visual indication
- Beacon shaped light modules available for low profile signaling applications
- IO-Link connectivity allows for real-time insight into the status of your control system



Component Selection

4 Select Top Sounder or Beacon



3 Select Light Modules or In-Line Sounders



2 Select Power or IO-link Module*



1 Select the Base Mounting Adaptor



* Not compatible with M12 5- or 8-pin connector bases.

Push Buttons



3-2...3-23

Signaling



3-24...3-35

Graphic Terminals



3-36...3-37



Product Selection

856T – Bases / Power Modules 1 2

Base Style	Base Adaptor ¹	Power Module 24V AC/DC up to 7 circuits	Power Module 120/240V AC up to 3 circuits	Power Module 120/240V AC up to 7 circuits	IO-Link Module
	Cat. No.	Cat. No. ⁵	Cat. No. ⁵	Cat. No. ⁵	Cat. No.
Surface Mounting 1/2 NPT	856T-BMASN	856T-B24C	856T-BAC3C	856T-BAC7C	856T-B24LC
Surface Mounting 1/2 NPT w/pre-installed screws	856T-BMASH	856T-B24C	856T-BAC3C	856T-BAC7C	856T-B24LC
Vertical Mount	856T-BMAVM	856T-B24C	856T-BAC3C	856T-BAC7C	856T-B24LC
Tube Mount	856T-BMAT ³	856T-B24C	856T-BAC3C	856T-BAC7C	856T-B24LC
Pole Mount	856T-BMAP ⁴	856T-B24C	856T-BAC3C	856T-BAC7C	856T-B24LC
M12 5-pin connector ²	856T-B24QD5C	-	-	-	
M12 8-pin connector ²	856T-B24QD8C	-	-	-	
Quick Release Base-10 cm ²	856T-B24Q10C	-	-	-	
Quick Release Base-25 cm ²	856T-B24Q25C	-	-	-	

¹ A complete mounting base requires a Base Adaptor and one of the Power Modules listed in the table. (i.e. 856T-BMASN+856T-B24C for a 24V DC surface mounting base).

² These are factory pre-assembled bases for 24V AC/DC only. They don't require power module selection. These bases are not compatible with the IO-Link module.

³ Available tube mount lengths are 10 and 25 cm choose one length to complete Base adaptor cat. Number. (i.e. 856T-BMAT10 or 856T-BMAT25)

⁴ Available pole mount lengths are 10, 25, 40 and 60 cm. Select one length to complete Base adaptor cat. Number. (i.e. 856T-BMAP10 or 856T-BMAP40)

⁵ All factory pre-assembled bases and power modules include a cap. IO-Link module does not include a cap.

856T – Light Modules 3

Function	Colors available ⁶	Cat. No.
LED Steady	G,R,A,B,W,Y,M	856T-BT ⁷
LED Multi function		856T-BB ⁷
LED Rotating	G,R,A,B,W,Y	856T-BR ⁷
7 color RGB LED Module	Can produce up to 7 colors	856T-BMC
LED Steady/Flashing - Beacon shape	G,R,A,B,W,Y	856T-BGB ⁷
LED Strobe - Beacon shape	R,A,B	856T-BSB ⁷
LED Rotating - Beacon shape	R,A	856T-BRB ⁷
7 color RGB LED Module - Beacon shape	Can produce up to 7 colors	856T-BMB

⁶ Denotes color where G=Green, R=Red, A=Amber, B=Blue, W=White, Y=Yellow, M=Magenta.

⁷ Catalog number is not complete. Please select a color designator: 3=Green, 4=Red, 5=Amber, 6=Blue, 7=White, 8=Yellow, 9= Magenta to complete catalog (i.e. 856T-BT4 is a LED steady Red).

856T – Accessories

Description	Cat. No.
Black cap	856T-ABCAP
O-ring for light modules, power modules and base adaptors	856T-ARNG
Gasket for surface mount base adaptor	856T-ASFG
Gasket for vertical mount base adaptor	856T-AVFG
Lens diffuser kit	856T-ADK
Screws for pole connection boxes	856T-AJBS
Vertical mounting bracket for pole, M12 and surface mount bases	855T-AVM

856T – Sound Modules 4

Function	Tones / Circuits	Sound Output	Cat. No.
Piezo Sounder - Top mount	8 tones - single circuit	105 dB at 1 m	856T-BP1
Piezo Sounder - In Line	8 tones - single circuit	102 dB at 1 m	856T-BPL1
Transducer Sounder ⁸	16 tables / 7 tones per table - 3 circuits	105 dB at 1 m	856T-BTR3
Recordable Sounder	up to 7 customer pre-recorded messages	90 dB at 1 m (voice) 95 dB at 1 m (tone)	856T-BH3

⁸ Three circuit sounders may work with fewer than three circuits. They can produce three tones / messages with two circuits available or one tone / message with one circuit available.

Specifications

Materials	Bases, Cap, Sound module housing, Lens, Pole foot, Diffuser	Polycarbonate
	Threaded Tube/Pole bases	Aluminum with clear powdercoat
	Gaskets and O-rings	Nitrile rubber
	Mounting screw washers	Polypropilene
Light Modules and Sounders Environmental Ratings	UL Type 4/4X/13, IP 66/67	
Operating Temperature Range	-30° to +70° C (-22° to +158° F)	
Mounting Options	Surface mount base, vertical base, aluminum pole base, M12 connector base, Quick release base, threaded tube base, 1/2" NPT conduit mount	
Flashing Frequency Multi-function Module	Flashing mode 2 Hz Single Strobe mode (1.4 Hz) Double Flash Strobe mode (1.4 Hz)	
Sound Module dB Rating	Piezo Top sounder (105 dB) In-line Piezo sounder (102 dB) Transducer sounder (105 dB)	
Certifications	cULus, CE Marked, KCC, RCM, RoHs compliant	



Signaling

Wall Mount Signal Lights 855W

- Up to six different conditions can be indicated (five visual and one audible) in the same device
- Wall mount does not add extra height to machine or equipment
- Units can be mounted vertically or horizontally
- IP65 ingress protection rating for indoor/outdoor and harsh environment use



855W wall mount signal lights are designed to communicate the status of different conditions in the machine or critical equipment in a compact size housing. Our signal lights are available in configurations from two- to five-light indicators with optional sound in the same unit.



Push Buttons



3-2...3-23

Signaling



3-24...3-35

Graphic Terminals



3-36...3-37

Product Selection

Voltage	Level 1		Level 2		Level 3		Level 4		Level 5		Grey Cover	Chrome Cover
	LED Module	Color	LED Module	Color	LED Module	Color	LED Module	Color	LED Module	Color	Cat. No. ¹	Cat. No. ¹
24V AC/DC	Steady	Green	Steady	Red	-	-	-	-	-	-	855W-G24Y3Y4	855W-C24Y3Y4
	Steady	Clear	Steady	Green	-	-	-	-	-	-	855W-G24Y7Y3	855W-C24Y7Y3
	Steady	Green	Flashing	Red	-	-	-	-	-	-	855W-G24Y3L4	855W-C24Y3L4
	Steady	Green	Steady	Amber	Steady	Red	-	-	-	-	855W-G24Y3Y5Y4	855W-C24Y3Y5Y4
	Steady	Red	Steady	Amber	Steady	Green	-	-	-	-	855W-G24Y4Y5Y3	855W-C24Y4Y5Y3
	Steady	Green	Flashing	Yellow	Flashing	Red	-	-	-	-	855W-G24Y3L8L4	855W-C24Y3L8L4
	Steady	Green	Steady	Red	Flashing	Amber	-	-	-	-	855W-G24Y3Y4L5	855W-C24Y3Y4L5
	Steady	Amber	Steady	Blue	Steady	Green	Steady	Red	-	-	855W-G24Y5Y6Y3Y4	855W-C24Y5Y6Y3Y4
	Steady	Clear	Steady	Green	Steady	Amber	Steady	Red	-	-	855W-G24Y7Y3Y5Y4	855W-C24Y7Y3Y5Y4
	Steady	Red	Steady	Amber	Steady	Blue	Steady	Green	Steady	Clear	855W-G24Y4Y5Y6Y3Y7	855W-C24Y4Y5Y6Y3Y7
	Flashing	Blue	Flashing	Amber	Flashing	Red	Flashing	Green	Flashing	Yellow	855W-G24L6L5L4L3L8	855W-C24L6L5L4L3L8
Flashing	Clear	Steady	Red	Steady	Blue	Steady	Amber	Steady	Yellow	855W-G24L7Y4Y6Y5Y8	855W-C24L7Y4Y6Y5Y8	
120V AC	Steady	Green	Steady	Red	-	-	-	-	-	-	855W-G10Y3Y4	855W-C10Y3Y4
	Steady	Green	Flashing	Red	-	-	-	-	-	-	855W-G10Y3L4	855W-C10Y3L4
	Flashing	Red	Steady	Yellow	-	-	-	-	-	-	855W-G10L4Y8	855W-C10L4Y8
	Flashing	Blue	Flashing	Clear	-	-	-	-	-	-	855W-G10L6L7	855W-C10L6L7
	Steady	Green	Steady	Amber	Steady	Red	-	-	-	-	855W-G10Y3Y5Y4	855W-C10Y3Y5Y4
	Flashing	Red	Flashing	Amber	Flashing	Blue	Flashing	Yellow	-	-	855W-G10L4L5L6L8	855W-C10L4L5L6L8
	Steady	Blue	Steady	Green	Steady	Amber	Steady	Red	-	-	855W-G10Y6Y3Y5Y4	855W-C10Y6Y3Y5Y4
	Steady	Clear	Steady	Blue	Steady	Green	Steady	Amber	Steady	Red	855W-G10Y7Y6Y3Y5Y4	855W-C10Y7Y6Y3Y5Y4

¹ For a signal light with piezo sound module add **P1** to the end of the catalog number For example, Catalog number 855W-G24Y3Y4 becomes Catalog number 855W-G24Y3Y4**P1**.

Specifications

Housing Material	Base	Polycarbonate (94V-0)
	Lens	Polycarbonate (94V-0)
	Rubber Seals and Gaskets	NBR 70
Environmental Ratings		UL Type 4/4X/13, IP65

Operation Temperature Range	-25...+50 °C (-13...+122 °F)
Mounting	Surface mounting. Can be mounted in any orientation.
Flashing LED Frequency	2 Hz
Piezo Sounder dB Rating	90 dBA (potentiometer adjustable down to 70 dB) determined at a distance of 1 meter from sound module



Signaling

Industrial Horns 855H/855HM

- Multi-tone, multi-stage (circuits), and voice playback capabilities
- Visualization option for enhanced industrial applications
- Surface and wall mount styles
- Multi-horn synchronization for most models
- Plastic and metal housings are heat and shock resistant, corrosion-free, suitable for harsh environments and outdoor applications



855H audible devices include general purpose, high-performance, and recordable electronic horns that provide multi-stage, multi-tone voice messaging and volume control capabilities. The high-performance and recordable horns are available as stand-alone devices or with beacons attached.

General Purpose



Mounting Options

- Surface mount
- Semi-flush mount

Sound Options

- 108...113 dB tones
- Three tones

Environmental Ratings

- Semi-flush mount:
UL Type 3R/13, IP54
- Surface mount:
UL Type 4/4X/13/3R,
IP66

High Performance



855H



855HM

Mounting Options

- Surface mount

Illumination Options

- 855H - Xenon tube (strobe, 5 J)
- 855HM - LED

Sound Options

- 855H - 10...126 dB outputs
- 855HM - 119 dB output
- Up to 45 tones and 3 circuits

Environmental Ratings

- 855H - Frame C and E: UL Type 3R, 4/4X, 13, IP66
- 855H - Frame A, B, and D: UL Type 13/3R, IP56
- 855HM - UL Type 4/4X/13/3R, IP66

Recordable



Mounting Options

- Surface mount
- Adjustable bracket (flare style)

Illumination Options

LED beacon (red, green, or amber)

Sound Options

- 101...111 dB voice
- 110...126 dB tone
- Up to 45 tones

Environmental Ratings

- Frame C and E:
UL Type 3R, 4/4X, 13, IP66
- Flare:
UL Type 3R, 4/4X, 13, IP66/IP67

Push
Buttons



3-2...3-23

Signaling



3-24...3-35

Graphic
Terminals



3-36...3-37

Product Selection

855H General Purpose Horns

Mounting Type	Function	Supply Voltage	Cat. No.
Surface base with conduit entrance	Standard (1 stage)	24V AC/DC	855H-SG24GPA
		120V AC	855H-SG10GPA
		240V AC	855H-SG20GPA
	Enhanced (2 stages)	10...30V DC	855H-SG30GPE
40...260V AC/DC		855H-SG45GPE	
Semi-flush wall plate	Standard (1 stage)	24V AC/DC	855H-FG24GPA
		120V AC	855H-FG10GPA
		240V AC	855H-FG20GPA

855H High Performance Horns and Combination Units with Optional Attached Beacon

Sound Output	Supply Voltage	Horn Only	Horn with Beacon
		Cat. No.	Cat. No. ¹
100 dB max. at 1 m, 2 circuit DC, 1 circuit AC, 10 selectable tones Frame A	24V DC	855H-BD30AD	855H-BCD24ADR3
	115V AC, 50/60 Hz	855H-BA10AD	855H-BCA10ADR3
	230V AC, 50/60 Hz	855H-BA20AD	855H-BCA20ADR3
104 dB max. at 1 m, 3 circuit AC or DC, 32 selectable tones Frame B	24V DC	855H-BD30BD	855H-BCD24BDR3
	115V AC, 50/60 Hz	855H-BA10BD	855H-BCA10BDR3
	230V AC, 50/60 Hz	855H-BA20BD	855H-BCA20BDR3
112 dB max. at 1 m, 3 circuit AC or DC, 32 selectable tones Frame C	24V DC	855H-BD30CD	855H-BCD24CDR3
	115V AC, 50/60 Hz	855H-BA10CD	855H-BCA10CDR3
	230V AC, 50/60 Hz	855H-BA20CD	855H-BCA20CDR3
119 dB max. at 1 m, 3 circuit AC or DC, 45 selectable tones Frame D	24V DC	855H-BD30DD	855H-BCD24DDR3
	115V AC, 50/60 Hz	855H-BA10DD	855H-BCA10DDR3
	230V AC, 50/60 Hz	855H-BA20DD	855H-BCA20DDR3
126 dB max. at 1 m, 3 circuit AC or DC, 45 selectable tones Frame E	24V DC	855H-BD30ED	855H-BCD24EDR3
	115V AC, 50/60 Hz	855H-BA10ED	855H-BCA10EDR3
	230V AC, 50/60 Hz	855H-BA20ED	855H-BCA20EDR3

¹ Catalog number listed is for a green beacon. For a different color, replace the **3** at the end of the catalog number with a **4** (red), **5** (amber), **6** (blue), **7** (clear), or **8** (yellow). Example: Catalog number 855H-BCD24ADR**3** becomes Catalog number 855H-BCD24ADR**5** for a horn with amber beacon.

855H Recordable Horns with Optional Attached Beacon

Description	Supply Voltage	Horn Only	Horn with Beacon
		Cat. No.	Cat. No. ¹
101 dB(A) voice, 110 dB(A) tone at 1 m, 45 selectable tones, 4 stages, Frame C	10...30V DC	855H-R30C	855H-RC30C3
		855H-R45C	855H-RC45C3
111 dB(A) voice, 126 dB(A) tone at 1 m, 45 selectable tones, 4 stages, Frame E	14...30V DC	855H-R30E	855H-RC30E3
		855H-R45E	855H-RC45E3
111 dB(A) voice, 126 dB(A) tone at 1 m, 45 selectable tones, 4 stages, Flare style	14...30V DC	855H-R30F	-
		855H-R45F	-

¹ Catalog number listed is for a green beacon. For a different color, replace the **3** at the end of the catalog number with a **4** (red) or **5** (amber). Example: Catalog number 855H-RC30C**3** becomes Catalog number 855H-RC30C**5** for a horn with amber beacon.

855HM High Performance Horn, Metal

Description	Supply Voltage	Horn Only	Horn with Beacon
		Cat. No.	Cat. No. ¹
119 dB max. at 1 m, 3 circuit AC or DC, 45 selectable tones	12...30V DC	855HM-GMD30D	855HM-CGMD30DL3
	115V AC, 50/60 Hz	855HM-GMA10D	855HM-CGMA10DL3
	230V AC, 50/60 Hz	855HM-GMA20D	855HM-CGMA20DL3

¹ Catalog number listed is for a green beacon. For a different color, replace the **3** at the end of the catalog number with a **4** (red), **5** (amber), **6** (blue) or **7** (clear). Example: Catalog number 855HM-CGMD30DL**3** becomes Catalog number 855HM-CGMD30DL**5** for a horn with amber beacon.



Product Selection Tools

Available online or for download, our tools help you access info while in the office or on the go.

<https://rok.auto/selection>



Signaling

Industrial Beacons 855B

- Three diameter sizes
- Illumination options: LED, halogen, and xenon tube
- Six colors available: green, red, amber, blue, clear, and yellow
- 855BS, 855BM, 855BL
 - Surface, NPT conduit, or tube mounting options
 - UL Type 4/4X/13, IP65
- 855B-GMS
 - Surface mount only
 - UL Type 3R, IP66



855B industrial beacons offer flexibility in size, mounting, voltages, colors, and illumination options to fit your application needs. The three diameter sizes are available in steady halogen, flashing halogen and rotating halogen versions. The 90 mm size offers also LED steady, flashing, strobe and three-color functionality.



855BS - 90 mm¹

Illumination Options

- Halogen bulb (steady/ flashing/ rotating)
- LED (steady/ flashing/ strobe/ 3-color)
- Xenon tube (strobe)

¹ LED option shown



855BM - 120 mm

Illumination Options

- Halogen bulb (steady/ flashing/ rotating)
- Xenon tube (strobe)



855BL - 160 mm

Illumination Options

- Halogen bulb (steady/ flashing/ rotating)
- Xenon tube (strobe)



855B-GMS - Square

Illumination Options

- Xenon tube (strobe)



Push Buttons



3-2...3-23

Signaling



3-24...3-35

Graphic Terminals



3-36...3-37

Product Selection





855BS 90 mm LED Round Beacons

	Steady/Flashing	Strobe	Multi-Color (green/red/amber)
Surface mount ¹	855BS-S◆SL□	855BS-S■BL□	855BS-S●ML345□
0.5 in. NPT mount	855BS-N◆SL□	855BS-N■BL□	855BS-N●ML345□
25 mm tube mount	855BS-T◆SL□	855BS-T■BL□	855BS-T●ML345□

¹ Surface mount base must be installed with rough wall plate (Catalog number 855BS-AWP) for UL Type 4/4X/13 rating, otherwise UL Type 1 only.

- ◆ Voltage Code: **35** = 24/48V AC/DC, **45** = 120/240V AC/DC
- Voltage Code: **35** = 24/48V AC/DC, **10** = 120V AC, **20** = 240V AC
- Voltage Code: **24** = 24V AC/DC, **10** = 120V AC, **20** = 240V AC
- Add lens color option code from table at right.

Lens Colors Options

		
3 = Green	4 = Red	5 = Amber
		
6 = Blue	7 = Clear	8 = Yellow

855BM 120 mm Round Beacons

	Steady	Rotating	Flashing	Strobe
Surface mount ²	855BM-S○DH□	855BM-S○RH□	855BM-S○FH□	855BM-S○BR□
0.5 in. NPT mount	855BM-N○DH□	855BM-N○RH□	855BM-N○FH□	855BM-N○BR□

² Surface mount base must be installed with rough wall plate (Catalog number 855BM-AWP) for UL Type 4/4X/13 rating, otherwise UL Type 1 only.

- Voltage Code: **24** = 24V AC/DC, **10** = 120V AC
- Add lens color option code from table at right.

855BL 160 mm Round Beacons

	Steady	Rotating	Flashing	Strobe
Surface mount ³	855BL-S○DH□	855BL-S○RH□	855BL-S○FH□	855BL-S○BR□
1 in. NPT mount	855BL-N○DH□	855BL-N○RH□	855BL-N○FH□	855BL-N○BR□

³ Surface mount base must be installed with rough wall plate (Catalog number 855BL-AWP) for UL Type 4/4X/13 rating, otherwise UL Type 1 only.

- Voltage Code: **24** = 24V AC/DC, **10** = 120V AC
- Add lens color option code from table at right.

855B Mini Square Beacon

Supply Voltage	Cat. No.
24V AC/DC	855B-GMS24R□
115V AC, 50/60 Hz	855B-GMS10R□

- Add lens color option code from table at right.



Looking for More?
 This catalog highlights only our most essential components; for a complete product selection, visit us at:
<https://rok.auto/directory>



Graphic Terminals

PanelView™ 800 Graphic Terminals 2711R

- High-resolution display (65K colors) with LED backlight, supporting simple graphic animation
- Communicate with MicroLogix™, Micro800™, CompactLogix™ 5370 and CompactLogix™ 5380 controllers and other devices using serial (RS232, RS422/485) protocols and Ethernet
- Review alarm status, history and time/date of equipment events even after power cycle
- Languages supported: French, German, Italian, Portuguese, Spanish and Simplified Chinese



The PanelView 800 graphic terminal features a high-speed processor, high-resolution display with LED backlight and internal memory; helping to improve productivity and maintenance, while enjoying the convenience and efficiencies of single-source buying.

Landscape and Portrait Modes



Serial or Ethernet Network

Optimized for use with Micro800 and MicroLogix controllers.

Connected Components Workbench Software

Connected Components Workbench™ software is a single software environment supporting...

- E200™ electronic overload relays
- Guardmaster® 440C-CR30 software configure safety relay
- Guardmaster speed monitory safety relays
- GuardShield™ 450L safety light curtains
- Kinetix® servo drives
- Micro800 controllers
- PanelView 800 graphic terminals
- PowerFlex® drives
- SMC™ soft starters

...in your standalone machines.

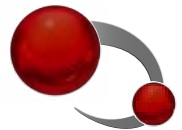

Push Buttons



3-2...3-23

Signaling



3-24...3-35

Graphic Terminals





3-36...3-37

Download the Connected Components Workbench Software!

<https://rok.auto/ccw>

Product Selection

PanelView™ 800 Specifications

Feature	4-inch	7-inch	10-inch
			
Catalog Number	2711R-T4T	2711R-T7T	2711R-T10T
Resolution	480 x 272 WQVGA	800 x 480 WVGA	800 x 600 SVGA
Display type	TFT touch screen, wide LCD		
Display hour	40,000 hours		
Colors	65K colors		
Backlight	LED		
Operator input	Resistive touch and tactile function keys	Resistive touch	
Power supply	24V DC		
Processor, CPU speed	800 MHz		
Internal storage	256 MB		
RAM	256 MB DDR		
Operation system	Microsoft Windows CE 6.0		
Real-time clock with battery	Yes		
Operating temperature	0...50 °C		
RS232/RS422/485 (isolated)	Separate RS232 and RS422/RS485 connectors		
Ethernet 10/100 Mbps	1		
USB host (USB 2.0)	Yes		
microSD™ slot	Yes		
Product dimension (mm) (height x width x depth)	116 x 138 x 43	144 x 197 x 54	225 x 287 x 55
Panel cutout (mm) (height x width)	99 x 119	125 x 179	206 x 269
Weight	0.35 kg (0.76 lb)	0.68 kg (1.48 lb)	1.57 kg (3.41 lb)
Front bezel protection	IP65, NEMA 4X, 12, 13		
Certifications	cULus listed; Class I Div 2, Groups A,B,C,D, T4A, CE, RCM, KC, RoHS		
Software	Connected Components Workbench software release 8.00 or later		

Accessories

Catalog Number	-	2711R-APK7	2711R-APK10
Accessories	-	7" Adapter plate kit	10" Adapter plate kit

For more information on our complete family of PanelView 800 Component products, please visit:
<https://rok.auto/PanelView800>



Additional Operator Interface Products



Hazardous Location Products

- 800G/H/R Push Buttons
- 855X/XM Horns and Beacons

Control Tower™ Stack Lights 855E (50 mm)

- UL Type 4/4X/13, IP65
- Stacking configurations 1...5 modules high
- Continuous or pulsing piezo sound modules



Compact Control Tower Stack Lights 855D (30 mm)

- UL Type 4/4X/13, IP65
- Steady and flashing LED light modules
- Continuous or pulsing piezo sound modules
- Multiple mounting options
- Factory pre-assembled and pre-wired



Panel Light Bars 855L

- Low voltage potential in panel
- Low heat output
- Low weight due to absence of heavy ballast
- Ideal for environments with high shock and vibration



Push Buttons



3-2...3-23

Signaling



3-24...3-35

Graphic Terminals



3-36...3-37

Terminal Blocks

Terminal Blocks.....	4-2
Push-in Terminal Blocks.....	4-4
Control Power Distribution Blocks.....	4-8
Sensor/Signal Blocks.....	4-12
Screw Clamp Terminal Blocks.....	4-14
Spring Clamp Terminal Blocks.....	4-21
Terminal Block Marking Systems.....	4-30
Power Distribution Blocks.....	4-32

Wiring Systems

Wiring Systems.....	4-34
---------------------	------

Signal Interface

Signal Conditioners.....	4-36
Intrinsic Safety Modules.....	4-38

Connection Systems

Non-network Connectivity Solutions.....	4-40
DC Micro Cordsets & Patchcords.....	4-42
AC Micro Cordsets & Patchcords.....	4-43
Mini Cordsets.....	4-44
Pico Cordsets & Patchcords.....	4-45
DC Micro & Pico Distribution Boxes.....	4-46
Terminal Chambers & IDC Connectors.....	4-47
Receptacles.....	4-48
Mini & Pico Receptacles.....	4-49

Safety Connection Systems

Safety Connectivity.....	4-50
Safety Distribution Boxes.....	4-52
Safety Wired T-Port & Shorting Plug.....	4-53

Network Media

Industrial Ethernet Connectivity.....	4-54
Ethernet Media Cable Spools.....	4-56
Ethernet M12 D Code Cordsets & Patchcords.....	4-57
Ethernet RJ45 Cordsets & Patchcords.....	4-58
Ethernet Accessories.....	4-59
Gigabit Ethernet Connectivity.....	4-60

Additional Connectivity Products..... 4-62

Terminal Blocks

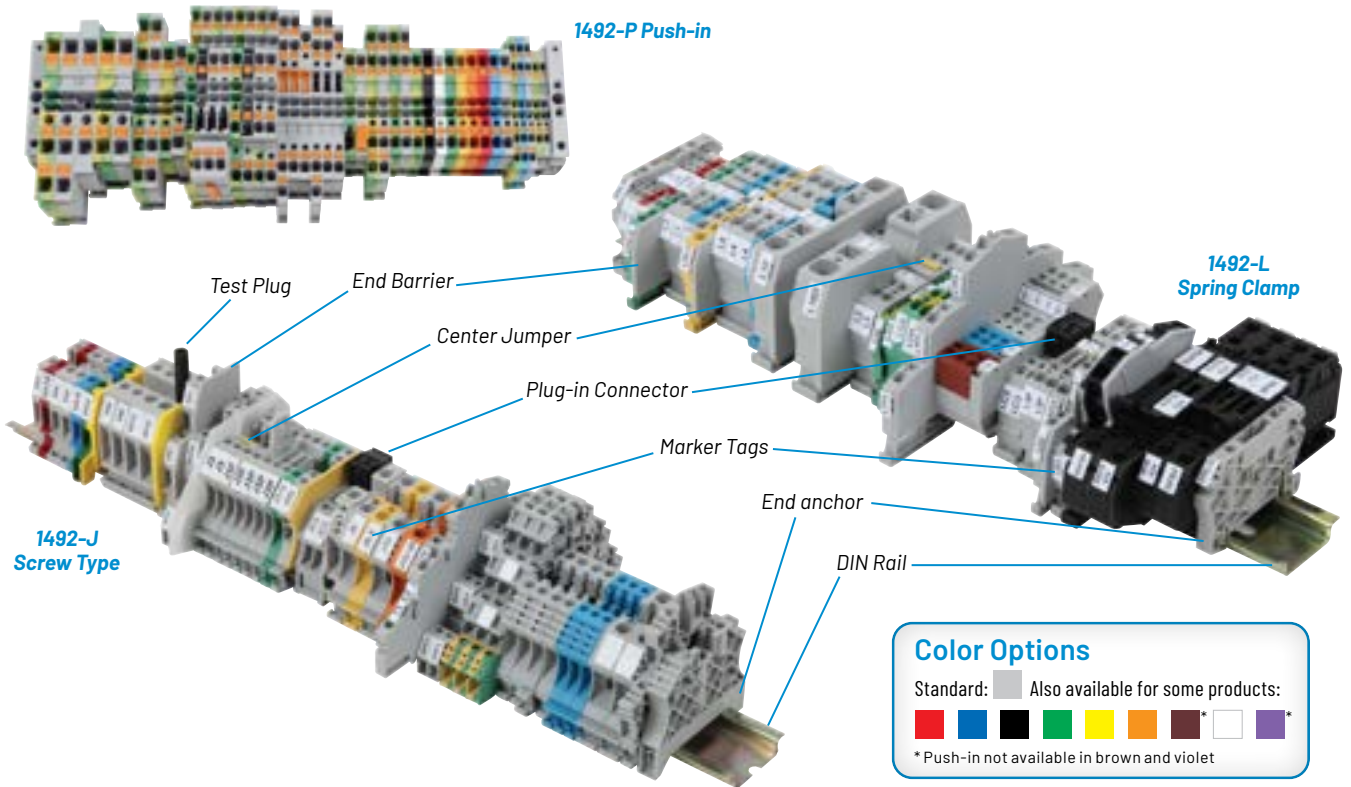

Leading the industry in efficiency and productivity, our family of IEC terminal blocks includes a broad range of DIN Rail mountable products. With push-in, screw and spring clamp connections available, they are designed for safety, installation ease, and ruggedness.

Push-in, Screw Type and Spring Clamp Terminal Blocks are Available in the Following Styles:

Standard Feed-through Terminal Blocks

- Designed for single-circuit feed-through applications

Multi-circuit Feed-through Terminal Blocks

- Designed for high-density wiring applications

Sensor Terminal Blocks

- Provide all connections needed for two-, three-, and four-wire applications in one terminal block

Grounding Terminal Blocks

- Provides easy to identify grounding bus that is mounted on the DIN Rail

Plug-in Style Terminal Blocks

- Allow for insertion of fixed components into control circuits (resistor, diodes, surge suppression circuit and shunt bars)

Fuse Blocks

- Provide better overcurrent protection in hinged-arm design

Control Power Distribution

- Available in Push-in Terminal Blocks

Terminal Blocks



4-2...4-33

Wiring Systems



4-34...4-35

Signal Interface



4-36...4-39

Connection Systems



4-40...4-49

Safety Connection Systems



4-50...4-53

Network Media



4-54...4-61



Push-in Terminal Blocks 1492-P

- When using an automated ferrule machine, installation time can be up to 65% faster than a screw clamp
- One-hand, one-second installation
- No torque values are needed to install or double check

Screw Clamp Terminal Blocks 1492-J

- All screw clamps have self-locking feature for unmatched connection reliability
- UL tested and approved for multiple wire terminations per connection terminal
- Use strong clamping materials to form gas-tight connection

* Product selection begins on page 4-14.

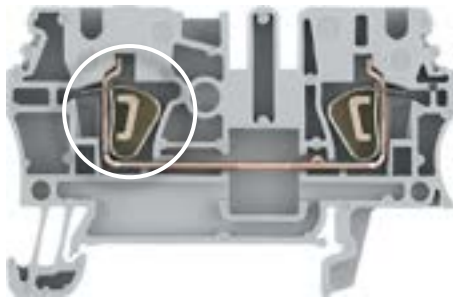
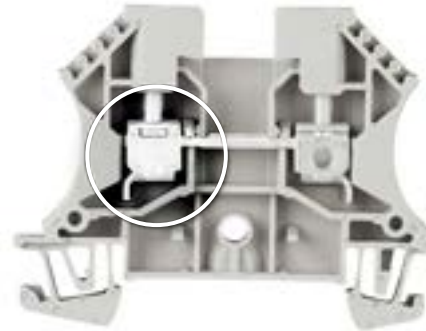

Spring Clamp Terminal Blocks 1492-L

- Help reduce wiring connection time by up to 30...50%
 - Excellent reliability performance in high-vibration environments
- Easy top-wire installation

* Product selection begins on page 4-21.

Available Accessories¹

- Marker cards
- Partition Plates
- DIN Rail
- End Anchor
- Jumpers

¹ DIN Rail and End Anchors can be found on page 4-29.
For accessory options, please visit
<https://rok.auto/directory>

All IEC Terminal Blocks are:

- IP2x finger-safe
- DIN Rail mount
- High fault short-circuit current rating (SCCR) with fuses and circuit breakers
- Meet IEC, UL, CSA and ATEX standards



Terminal Blocks

Product Selection

Standard Feed-through Terminal Blocks, Push-in (3...6 mm wire size)

<p>Dimensions are not intended to be used for manufacturing purposes.</p> <p>Note: Height for dimension is measured from top of rail to top of terminal block.</p>									
	1492-P3			1492-P4			1492-P6		
Standards	UR/CSA	IEC	ATEX	UR/CSA	IEC	ATEX	UR/CSA	IEC	ATEX
Voltage rating [V AC/DC]	600	800	550	600	800	550	600	800	550
Maximum current [A]	20	24	21	30	32	30	38	41	36
Wire range (Rated cross section)	#28...12 AWG	2.5 mm ²	2.5 mm ²	#26...10 AWG	4 mm ²	4 mm ²	#22...8 AWG	6 mm ²	6 mm ²
Terminal block	Cat. No.	Pkg. Qty.		Cat. No.	Pkg. Qty.		Cat. No.	Pkg. Qty.	
Grey	1492-P3	100		1492-P4	100		1492-P6	50	
Color	1492-P3-⊗			1492-P4-⊗			1492-P6-⊗		

Standard Feed-through Terminal Blocks, Push-in (10...16 mm wire size)

<p>Dimensions are not intended to be used for manufacturing purposes.</p> <p>Note: Height for dimension is measured from top of rail to top of terminal block.</p>						
	1492-P10			1492-P16		
Two-level, Feed-through terminal block with commoning bar						
Standards	UR/CSA	IEC	ATEX	UR/CSA	IEC	ATEX
Voltage rating [V AC/DC]	600	1000	550	600	1000	550
Maximum current [A]	55	57	52	62	76	64
Wire range (Rated cross section)	#20...6 AWG	10 mm ²	10 mm ²	#18...6 AWG	16 mm ²	16 mm ²
Terminal block	Cat. No.	Pkg. Qty.		Cat. No.	Pkg. Qty.	
Grey	1492-P10	25		1492-P16	20	
Color	1492-P10-⊗			1492-P16-⊗		

⊗ For colored terminal blocks, replace the ⊗ in the catalog number with the following: **RE** = Red, **B**= Blue, **BL** = Black, **G**= Green, **Y**= Yellow, **OR**= Orange, **W**=White, to the end of the catalog number.

Terminal Blocks

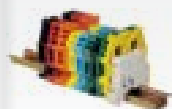

4-2...4-33



4-34...4-35



4-36...4-39



4-40...4-49



4-50...4-53



4-54...4-61

Product Selection

Multi-circuit Two-Level Feed-through Terminal Blocks, Push-in (3 mm wire size)

<p>Dimensions are not intended to be used for manufacturing purposes.</p> <p>Note: Height for dimension is measured from top of rail to top of terminal block.</p>						
	1492-PD3			1492-PD3C		
Two-level, Feed-through terminal block with commoning bar						
Standards	UR/CSA	IEC	ATEX	UR/CSA	IEC	ATEX
Voltage rating [V AC/DC]	600	800	550	600	800	550
Maximum current [A]	20	24	21	20	24	21
Wire range (Rated cross section)	#28...12 AWG	2.5 mm ²	2.5 mm ²	#28...12 AWG	2.5 mm ²	2.5 mm ²
Terminal block	Cat. No.	Pkg. Qty.		Cat. No.	Pkg. Qty.	
Grey	1492-PD3	50		1492-PD3C	50	
Color	1492-PD3-⊗			1492-PD3C-⊗		

Multi-circuit Two-Level Feed-through Terminal Blocks, Push-in (4 mm wire size)

<p>Dimensions are not intended to be used for manufacturing purposes.</p> <p>Note: Height for dimension is measured from top of rail to top of terminal block.</p>						
	1492-PD4			1492-PD4C		
Two-level, Feed-through terminal block with commoning bar						
Standards	UR/CSA	IEC	ATEX	UR/CSA	IEC	ATEX
Voltage rating [V AC/DC]	600	800	550	600	800	550
Maximum current [A]	30	32	25	30	32	25
Wire range (Rated cross section)	#26...10 AWG	4 mm ²	4 mm ²	#26...10 AWG	4 mm ²	4 mm ²
Terminal block	Cat. No.	Pkg. Qty.		Cat. No.	Pkg. Qty.	
Grey	1492-PD4	50		1492-PD4C	50	
Color	1492-PD4-⊗			1492-PD4C-B		

⊗ For colored terminal blocks, replace the ⊗ in the catalog number with the following: **RE** = Red, **B** = Blue, **BL** = Black, **G** = Green, **Y** = Yellow, **OR** = Orange, **W** = White, to the end of the catalog number.

For more information on our complete family of push-in terminal block products, please visit:
<https://rok.auto/push-in-terminal-blocks>



Terminal Blocks

Product Selection

Multi-circuit Three-Level Feed-through Terminal Blocks, Push-in (3 mm wire size)

<p>Dimensions are not intended to be used for manufacturing purposes.</p> <p>Note: Height for dimension is measured from top of rail to top of terminal block.</p>						
	1492-PT3			1492-PT3C		
Two-level, Feed-through terminal block with commoning bar						
Standards	UR/CSA	IEC	ATEX	UR/CSA	IEC	ATEX
Voltage rating [V AC/DC]	600	800	550	600	800	550
Maximum current [A]	20	24	21	20	24	21
Wire range (Rated cross section)	#28...12 AWG	2.5 mm ²	2.5 mm ²	#28...12 AWG	2.5 mm ²	2.5 mm ²
Terminal block	Cat. No.	Pkg. Qty.		Cat. No.	Pkg. Qty.	
Grey	1492-PT3	50		1492-PT3C	50	
Color	1492-PT3-B			1492-PT3C-B		

Grounding Terminal Blocks, Push-in (3...6 mm wire size)

<p>Dimensions are not intended to be used for manufacturing purposes.</p> <p>Note: Height for dimension is measured from top of rail to top of terminal block.</p>									
	1492-PG3			1492-PG4			1492-PG6		
Standards	UR/CSA	IEC	ATEX	UR/CSA	IEC	ATEX	UR/CSA	IEC	ATEX
Voltage rating [V AC/DC]	600	800	550	600	800	550	600	800	550
Wire range (Rated cross section)	#28...12 AWG	2.5 mm ²	2.5 mm ²	#26...10 AWG	4 mm ²	4 mm ²	#22...8 AWG	6 mm ²	6 mm ²
Wire strip length	0.4 in. (10 mm)			0.47 in. (12 mm)			0.47 in. (12 mm)		
Density	59 pcs/ft (196 pcs/m)			49 pcs/ft (163 pcs/m)			37 pcs/ft (123 pcs/m)		
Housing temperature range	-76...266°F (-60...130 °C)			-76...266°F (-60...130 °C)			-76...266°F (-60...130 °C)		
Terminal block	Cat. No.	Pkg. Qty.		Cat. No.	Pkg. Qty.		Cat. No.	Pkg. Qty.	
Green/Yellow	1492-PG3	50		1492-PG4	50		1492-PG6	50	

⊗ For colored terminal blocks, replace the ⊗ in the catalog number with the following: **RE** = Red, **B** = Blue, **BL** = Black, **G** = Green, **Y** = Yellow, **OR** = Orange, **W** = White, to the end of the catalog number.

Terminal Blocks



4-2...4-33

Wiring Systems



4-34...4-35

Signal Interface



4-36...4-39

Connection Systems



4-40...4-49

Safety Connection Systems



4-50...4-53

Network Media



4-54...4-61



Product Selection

Grounding Terminal Blocks, Push-in (10...16 mm wire size)

Dimensions are not intended to be used for manufacturing purposes.

Note: Height for dimension is measured from top of rail to top of terminal block.

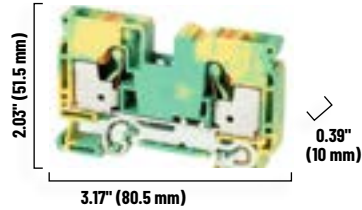

1492-PG10

Two-level, Feed-through terminal block with commoning bar

Standards	UR/CSA	IEC	ATEX
Voltage rating [V AC/DC]	600	1000	550
Wire range (Rated cross section)	#20...6 AWG	10 mm ²	10 mm ²
Wire Strip Length	0.71 in (18 mm)		
Density	30 pcs/ft (100 pcs/m)		
Housing Temperature Range	-76...+266°F (-60...+130 °C)		
Terminal block	Cat. No.	Pkg. Qty.	
Green/Yellow	1492-PG10	25	

Dimensions are not intended to be used for manufacturing purposes.

Note: Height for dimension is measured from top of rail to top of terminal block.

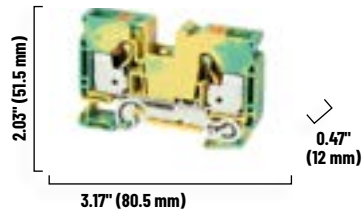

1492-PG16

Two-level, Feed-through terminal block with commoning bar

Standards	UR/CSA	IEC	ATEX
Voltage rating [V AC/DC]	600	1000	550
Wire range (Rated cross section)	#18...6 AWG	16 mm ²	16 mm ²
Wire Strip Length	0.71 in (18 mm)		
Density	25 pcs/ft (83 pcs/m)		
Housing Temperature Range	-76...+266°F (-60...+130 °C)		
Terminal block	Cat. No.	Pkg. Qty.	
Green/Yellow	1492-PG16	20	

⊗ For colored terminal blocks, replace the ⊗ in the catalog number with the following: **RE** = Red, **B** = Blue, **BL** = Black, **G** = Green, **Y** = Yellow, **OR** = Orange, **W** = White, to the end of the catalog number.



Terminal Blocks

Control Power Distribution Blocks

Colored actuators make it easy to distinguish between the positive and negative potentials

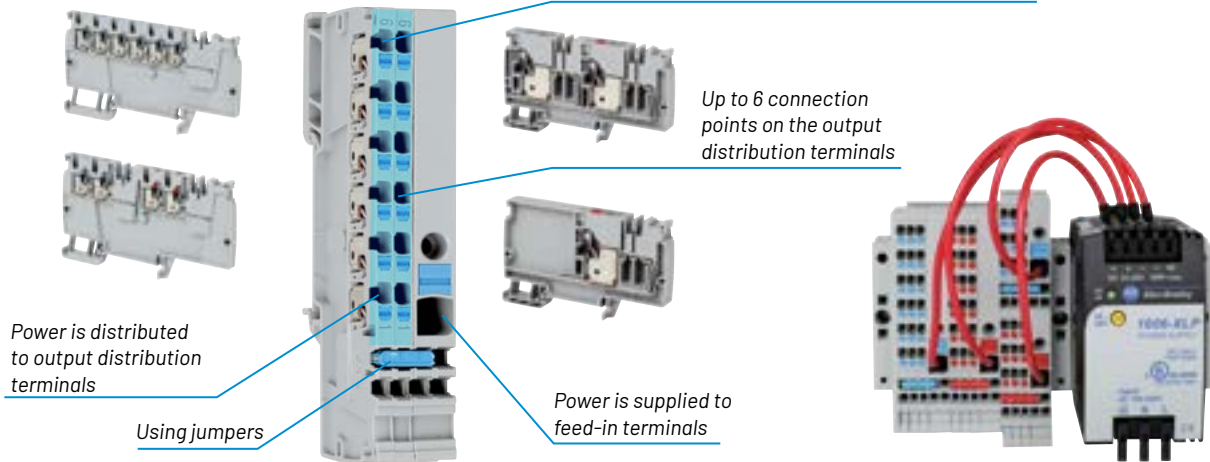

Control Power Distribution			
Color	Catalog Number		Wire Range (Rated cross section)
	Start (Feed-in)	End (Output)	
Standard	1492-P6PD2S-1B ¹	-	22-8 AWG (6.0 mm ²)
Standard	1492-P6PD2S-1RE ¹	-	
with Grounding ³	1492-P66PD2S ¹	-	
Standard	-	1492-P6PD2E-6B ¹	26-14 AWG (1.5mm ²)
Standard	-	1492-P6PD2E-6RE ¹	
Standard	1492-P6PD2S-1B1RE ²	-	22-8 AWG (6.0 mm ²)
with Grounding ³	1492-P6PD2S-1RE1G ²	-	
Standard	-	1492-P6PD2E-3B3RE ²	26-14 AWG (1.5mm ²)
Ferrules	For specific information on which Panduit ferrules to use with individual Bulletin 1492-P Push-in Terminal Blocks, consult Appendix sections in Publication 1492-TD017.		

Control Power Distribution			
Color	Catalog Number		Wire Range (Rated cross section)
	Start (Feed-in)	End (Output)	
Standard	1492-P10PD3S-1B ¹	-	22-6 AWG (10.0 mm ²)
Standard	1492-P10PD3S-1RE ¹	-	
with Grounding ³	1492-PG10PD3S ¹	-	
Standard	-	1492-P10PD3E-5B ¹	28-12 AWG (2.5mm ²)
Standard	-	1492-P10PD3E-5RE ¹	
Standard	1492-P10PD3S-1B1RE ²	-	22-6 AWG (10.0 mm ²)
with Grounding ³	1492-P10PD3S-1RE1G ²	-	
Standard	-	1492-P10PD3E-2B2RE ²	28-12 AWG (2.5mm ²)
Ferrules	For specific information on which Panduit ferrules to use with individual Bulletin 1492-P Push-in Terminal Blocks, consult Appendix sections in Publication 1492-TD017.		

¹ Shape/Size Configuration #1: (+/-) on separate terminal blocks.

² Shape/Size Configuration #2: (+/-) integrated into a single terminal block.

³ Not grounded to the DIN Rail. This is a functional earth ground that allows you ground the minus potential of the power supply to 0 V.

Terminal Blocks

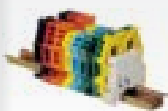

4-2...4-33

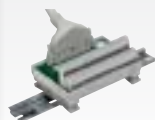

4-34...4-35



4-36...4-39



4-40...4-49



4-50...4-53



4-54...4-61

Control Power Distribution Blocks



1492-P10PD4E-KD



1492-P10PD4E-FB*

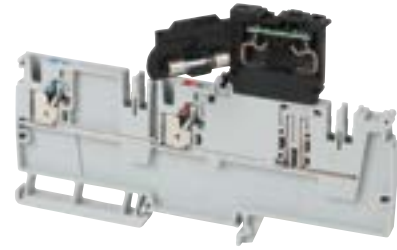

1492-P10PD4E-1B1FB*

Block Type	Catalog Number		Wire Range (Rated Cross Section)
	Start (Feed-in)	End (Output)	
Standard	1492-P10PD4S-1B ¹		20-6 AWG (10.0 mm ²)
Standard	1492-P10PD4S-1RE ¹		20-6 AWG (10.0 mm ²)
with Grounding ³	1492-PG10PD4S ¹		20-6 AWG (10.0 mm ²)
Standard		1492-P10PD4E-1B ¹	26-10 AWG (4.0 mm ²)
Standard		1492-P10PD4E-1RE ¹	26-10 AWG (4.0 mm ²)
Standard		1492-P10PD4E-KD ^{1,4}	26-10 AWG (4.0 mm ²)
Standard		1492-P10PD4E-FB ^{1,5}	26-10 AWG (4.0 mm ²)
Standard		1492-P10PD4E-FB24 ^{1,6}	26-10 AWG (4.0 mm ²)
Standard		1492-P10PD4E-FB48 ^{1,6}	26-10 AWG (4.0 mm ²)
Standard		1492-P10PD4E-FB120 ^{1,6}	26-10 AWG (4.0 mm ²)
Standard		1492-P10PD4E-FB250 ^{1,6}	26-10 AWG (4.0 mm ²)
Standard	1492-P10PD4S-1B1RE ²		20-6 AWG (10.0 mm ²)
with Grounding ³	1492-P10PD4S-1RE1G ²		20-6 AWG (10.0 mm ²)
Standard		1492-P10PD4E-1B1FB ^{2,5}	26-10 AWG (4.0 mm ²)
Standard		1492-P10PD4E-1B1FB24 ^{2,6}	26-10 AWG (4.0 mm ²)
Standard		1492-P10PD4E-1B1FB48 ^{2,6}	26-10 AWG (4.0 mm ²)
Standard		1492-P10PD4E-1B1FB120 ^{2,6}	26-10 AWG (4.0 mm ²)
Standard		1492-P10PD4E-1B1FB250 ^{2,6}	26-10 AWG (4.0 mm ²)

¹ Shape/Size Configuration #1: (+/-) on separate terminal blocks

² Shape/Size Configuration #2: (+/-) integrated into a single terminal block

³ Not grounded to the Din Rail. This is a functional earth ground that allows you ground the minus potential of the power supply to 0 V.

⁴ Includes knife disconnect/isolation

⁵ Includes non indicating fuse holder

⁶ Includes LED indicating fuse holder

* Available in non-indicating and LED indicating. LED indicating is available in 24, 48, 120 and 250V AC/DC.



Terminal Blocks

Product Selection

Isolation & Plug-in Terminal Blocks, Push-in

<p>Dimensions are not intended to be used for manufacturing purposes.</p> <p>Note: Height for dimension is measured from top of rail to top of terminal block.</p>						
		1492-PKD3			1492-P3P	
Standards		UR/CSA	IEC	ATEX	UR/CSA	IEC
Voltage rating [V AC/DC]		300	500	400	300	500
Maximum current [A]		20	20	20	20	20
Wire range (Rated cross section)		#28...12 AWG	2.5 mm ²	2.5 mm ²	#28...12 AWG	2.5 mm ²
Terminal block						
Gray		1492-PKD3	50	1492-P3P	50	
Blue		1492-PKD3-B		-	-	
Accessories		Cat. No.	Pkg. Qty.	Cat. No.	Pkg. Qty.	
End Barrier		1492-EBP3Q	50	1492-EBP3Q	20	
Plug-in center jumper	10-pole	1492-CJP3-10	20	1492-CJP3-10	20	
	2-pole	1492-CJP3-2	60	1492-CJP3-2	60	
Disconnect plug		-	-	1492-DPL	50	
Component plug		-	-	1492-CPL	50	
Without blown fuse indicator		-	-	1492-FPK2	20	
10...36V blown fuse indicator		-	-	1492-FPK224	20	
35...75V blown fuse indicator		-	-	1492-FPK248	20	
60...150V blown fuse indicator		-	-	1492-FPK2120	20	
140...250V blown fuse indicator		-	-	1492-FPK2250	20	
Test Plugs	Start Test Plug	1492-PTPS	50	1492-PTPS	50	
	Test Plug	1492-P3TPE		1492-P3TPE		
Marking Systems	ClearPlot Basic Marker Cards	1492-MR5X8 (120/card)	5 cards	1492-MR5X8 (120/card)	5 cards	
	ClearMultiprint Markers	1492-MT5X8 (800/roll)	1 roll	1492-MT5X8 (800/roll)	1 roll	
Ferrules		For specific information on which Panduit ferrules to use with individual Bulletin 1492-P Push-in Terminal Blocks, consult Appendix sections in Publication 1492-TD017.				

⊗ For colored terminal blocks, replace the ⊗ in the catalog number with the following: **RE** = Red, **B** = Blue, **BL** = Black, **G** = Green, **Y** = Yellow, **OR** = Orange, **W** = White, to the end of the catalog number.

¹ Available in orange as standard, to order other colors add the appropriate suffix to the catalog number listed: Blue =B, Red = RE. Example for a red 2-pole center jumper, the catalog number will be 1492-CJP3-2-RE.

Terminal Blocks



4-2...4-33

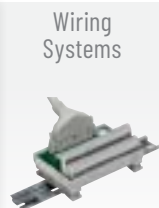

4-34...4-35



4-36...4-39

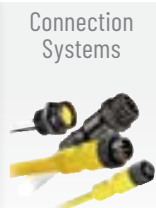

4-40...4-49



4-50...4-53



4-54...4-61



Product Selection

Fuse Blocks, Push-in

<p>Dimensions are not intended to be used for manufacturing purposes.</p> <p>Note: Height for dimension is measured from top of rail to top of terminal block.</p>				
		1492-PG10		
Standards		UR/CSA	IEC	ATEX
Voltage rating [V AC/DC]	1492-PFB4	300	250	250
	1492-PFB424		10...36	
	1492-PFB448		30...70	
	1492-PFB4120		60...150	
	1492-PFB4250		100...250	
Maximum current [A]		10	6.3	6.3
Wire range (Rated cross section)		#26...10 AWG	4 mm ²	4 mm ²
Wire Strip Length		0.47 in. (12 mm)		
Density		49 pcs/ft (163 pcs/m)		
Housing Temperature Range		-76...266°F (-60...130 °C)		
Fuse Size		5 x 20 mm		
Terminal block	Color	Includes LED for Blown Fuse Indication	Cat. No.	Pkg. Qty.
	Black	No	1492-PFB4	50
		Yes	1492-PFB424	
			1492-PFB448	
			1492-PFB4120	
1492-PFB4250				
Accessories		Cat. No.	Pkg. Qty.	
End Barrier		1492-EBP4T	20	
Center Jumpers ¹	2-pole	Orange	1492-CJP4-2	60
Test Plugs		Start Test Plug	1492-PTPS	50
		Test Plug	1492-P4TPE	50
Marking Systems		ClearMark Advanced and ClearPlot Basic Marker Cards	1492-MR6X8 (120/card)	5 cards
		ClearMultiprint Markers	1492-MT6X8 (600/roll)	1 roll
Ferrules	For specific information on which Panduit ferrules to use with individual Bulletin 1492-P Push-in Terminal Blocks, consult Appendix sections in Publication 1492-TD017.			

¹ Available in orange as standard, to order other colors add the appropriate suffix to the catalog number listed: Blue =B, Red =RE. Example for a red 2-pole center jumper, the catalog number will be 1492-CJP3-2-RE. Multiple pole sizes available.



Terminal Blocks

Sensor/Signal Blocks

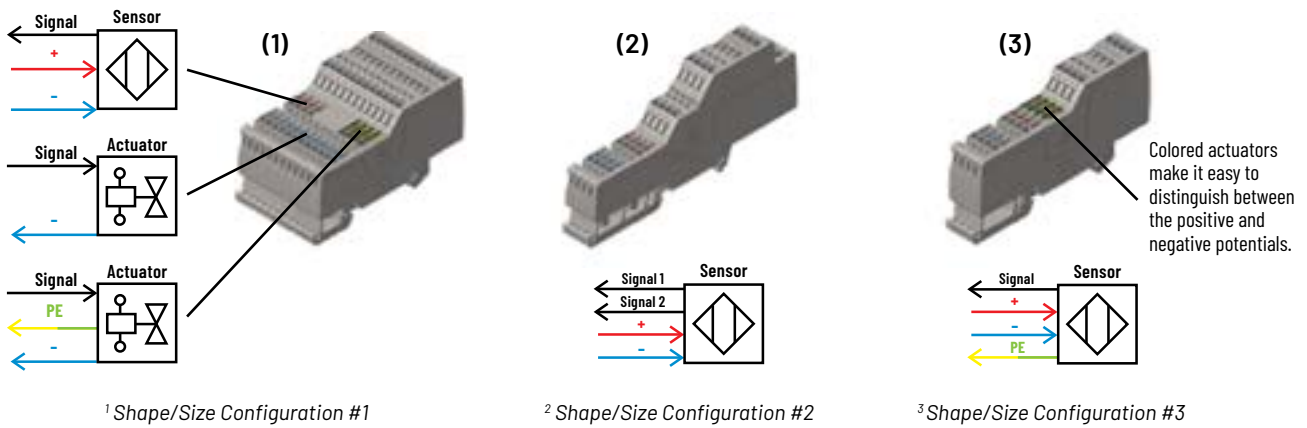

Sensor/Signal				
Color	Catalog Number			Wire Range (Rated cross section)
	2 Circuit	3 Circuit	4 Circuit	
Standard	1492-PS2-2 ¹	1492-PS2-3 ¹	1492-PS2-4 ²	26-14 AWG (1.5mm ²)
with Grounding	-	1492-PSG2-3 ¹	1492-PSG2-4 ³	26-14 AWG (1.5mm ²)
Ferrules	For specific information on which Panduit ferrules to use with individual Bulletin 1492-P Push-in Terminal Blocks, consult Appendix sections in Publication 1492-TD017.			

Terminal Blocks



4-2...4-33

Wiring Systems



4-34...4-35

Signal Interface



4-36...4-39

Connection Systems



4-40...4-49

Safety Connection Systems



4-50...4-53

Network Media



4-54...4-61

Accessories

			1492-P3		1492-P4		1492-P6	
Accessories			Cat. No.	Pkg. Qty.	Cat. No.	Pkg. Qty.	Cat. No.	Pkg. Qty.
End Barrier			1492-EBP3	50	1492-EBP4	50	1492-EBP6	50
Center Jumpers ¹	2-pole	Orange	1492-CJP3-2	60	1492-CJP4-2	60	1492-CJP6-2	60
Test Plugs	Start Test Plug		1492-PTPS	50	1492-PTPS	50	1492-PTPS	50
	Test Plug		1492-P3TPE		1492-P4TPE		1492-P6TPE	
Marking Systems	ClearPlot Basic Marker Cards		1492-MR5X8 (120/card)	5 cards	1492-MR6X8 (120/card)	5 cards	1492-MR8X10 (120/card)	5 cards
	ClearMultiprint Markers		1492-MT5X8 (800/roll)	1 roll	1492-MT6X8 (600/roll)	1 roll	1492-MT8X8 (500/roll)	1 roll
Ferrules			For specific information on which Panduit ferrules to use with individual Bulletin 1492-P Push-in Terminal Blocks, consult Appendix sections in Publication 1492-TD017.					

			1492-P10		1492-P16	
Accessories			Cat. No.	Pkg. Qty.	Cat. No.	Pkg. Qty.
End Barrier			1492-EBP10/16	20	1492-EBP10/16	20
Center Jumpers ¹	2-pole	Orange	1492-CJP10-2	25	1492-CJP16-2	25
Test Plugs	Start Test Plug		1492-PTPS	50	1492-PTPS	50
	Test Plug		1492-P10TPE	50	1492-P10TPE	
Marking Systems	ClearMark Advanced and ClearPlot Basic Marker Cards ²		1492-MR5X8 (120/card)	5 cards	1492-MR6X8 (120/card)	5 cards
	ClearMultiprint Markers		1492-MT10X8 (370/roll)	1 roll	1492-MT12X8 (320/roll)	1 roll
Ferrules			For specific information on which Panduit ferrules to use with individual Bulletin 1492-P Push-in Terminal Blocks, consult Appendix sections in Publication 1492-TD017.			

			1492-PD3		1492-PD4		1492-PT3	
Accessories			Cat. No.	Pkg. Qty.	Cat. No.	Pkg. Qty.	Cat. No.	Pkg. Qty.
End Barrier			1492-EBPD3	20	1492-EBPD4	20	1492-EBPT3	20
Center Jumpers ¹	2-pole	Orange	1492-CJP3-2	60	1492-CJP4-2	60	1492-CJP3-2	60
Test Plugs	Start Test Plug		1492-PTPS	50	1492-PTPS	50	1492-PTPS	50
	Test Plug		1492-P3TPE		1492-P4TPE		1492-P3TPE	
Marking Systems	ClearPlot Basic Marker Cards		1492-MR5X8 (120/card)	5 cards	1492-MR6X8 (120/card)	5 cards	1492-MR5X8 (120/card)	5 cards
	ClearMultiprint Markers		1492-MT5X8 (800/roll)	1 roll	1492-MT6X8 (600/roll)	1 roll	1492-MT5X8 (800/roll)	1 roll
Ferrules			For specific information on which Panduit ferrules to use with individual Bulletin 1492-P Push-in Terminal Blocks, consult Appendix sections in Publication 1492-TD017.					

¹ Available in orange as standard, to order other colors add the appropriate suffix to the catalog number listed: Blue =B, Red = RE. Example for a red 2-pole center jumper, the catalog number will be 1492-CJP3-2-RE. Multiple pole sizes available.

² Two marker card markers per terminal block are required.



Terminal Blocks

Product Selection

Standard Feed-through Terminal Blocks, Screw Type

<p>Dimensions are not intended to be used for manufacturing purposes.</p> <p>Note: Height for dimension is measured from top of rail to top of terminal block.</p>												
	1492-J3				1492-J4				1492-J6			
Standards	UR	CSA	IEC	ATEX	UR	CSA	IEC	ATEX	UR	CSA	IEC	ATEX
Voltage rating [V AC/DC]	600		800	550	600		800	690	600		800	550
Maximum current [A]	25	20	24	21	35	25	32	28	50		41	36
Wire range (Rated cross section)	#28... 12 AWG	#26... 12 AWG	2.5 mm ²	2.5 mm ² (#20... 14 AWG)	#22... 10 AWG	#26... 10 AWG	4 mm ²	4 mm ² (#20... 12 AWG)	#22... 8 AWG		6 mm ²	6 mm ² (#20... 10 AWG)
Terminal block	Cat. No.		Pkg. Qty.		Cat. No.		Pkg. Qty.		Cat. No.		Pkg. Qty.	
Grey	1492-J3		100		1492-J4		100		1492-J6		100	
Color	1492-J3-⊗		100		1492-J4-⊗		100		1492-J6-⊗		100	
Accessories	Cat. No.		Pkg. Qty.		Cat. No.		Pkg. Qty.		Cat. No.		Pkg. Qty.	
End barrier	1492-EBJ3		50		1492-EBJ4		50		1492-EBJ6		50	
Screw center jumper 2-pole	1492-CJJ5-2		50		1492-CJJ6-2		50		1492-CJJ8-2		50	
Plug-in center jumper 2-pole	1492-CJLJ5-2		60		1492-CJLJ6-2		60		-		-	
Partition plates	1492-EBJ16		20		1492-EBJ16		20		1492-EBJ16		20	
Snap-in marker cards	1492-MR5X12		5 cards (120/card)		1492-MR6X12		5 cards (120/card)		1492-MR8X12		5 cards (84/card)	
Snap-in marker tags for ClearMultiprint	1492-MT5X12		800		1492-MT6X12		600		1492-MT8X12		500	

⊗ For colored terminal blocks, replace the ⊗ in the catalog number with the following: **RE** = Red, **B** = Blue, **BL** = Black, **G** = Green, **Y** = Yellow, **OR** = Orange, **BR** = Brown, **W** = White, to the end of the catalog number. Multiple pole sizes available.

Terminal Blocks

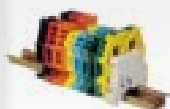

4-2...4-33

Wiring Systems



4-34...4-35

Signal Interface



4-36...4-39

Connection Systems



4-40...4-49

Safety Connection Systems



4-50...4-53

Network Media



4-54...4-61

Product Selection

Standard Feed-through Terminal Blocks, Screw Type

<p>Dimensions are not intended to be used for manufacturing purposes.</p> <p>Note: Height for dimension is measured from top of rail to top of terminal block.</p>												
	1492-J10				1492-J16				1492-J35			
Standards	UR	CSA	IEC	ATEX	UR	CSA	IEC	ATEX	UR	CSA	IEC	ATEX
Voltage rating [V AC/DC]	600		1000	550	600		1000	690	1000	600	1000	690
Maximum current [A]	65	50	57	50	85	76	66	150	120	125	109	
Wire range (rated cross section)	#18... 6 AWG		10 mm ²	10 mm ² (#16... 8 AWG)	#18... 4 AWG		16 mm ²	16 mm ² (#16... 6 AWG)	12... 1/0 AWG	12... 2 AWG	35 mm ²	35 mm ² (#14... 2 AWG)
Terminal block	Cat. No.		Pkg. Qty.		Cat. No.		Pkg. Qty.		Cat. No.		Pkg. Qty.	
Grey	1492-J10		50		1492-J16		50		1492-J35		40	
Color	1492-J10-⊗		50		1492-J16-⊗		50		-		-	
Accessories	Cat. No.		Pkg. Qty.		Cat. No.		Pkg. Qty.		Cat. No.		Pkg. Qty.	
End barrier	1492-EBJ3		50		1492-EBJ16		20		1492-EBJ16		20	
Screw center jumper 2-pole	1492-CJJ10-2		50		1492-CJJ12-2		20		1492-CJJ16-2		20	
Partition plates	1492-EBJ16		20		1492-PPJD3		20		1492-PPJD3		20	
Snap-in marker cards	1492-M7X12		5 cards (108/card)		1492-M7X12		5 cards (108/card)		1492-M7X12		5 cards (108/card)	
Snap-in marker tags for ClearMultiPrint	1492-MT5X12		800		1492-MT6X12		600		1492-MT8X12		500	

⊗ For colored terminal blocks, replace the ⊗ in the catalog number with the following: **RE** = Red, **B** = Blue, **BL** = Black, **G** = Green, **Y** = Yellow, **OR** = Orange, **BR** = Brown, **W** = White, to the end of the catalog number. Multiple pole sizes available.



Terminal Blocks

Product Selection

Multi-circuit Feed-through Terminal Blocks, Screw Type

<p>Dimensions are not intended to be used for manufacturing purposes.</p> <p>Note: Height for dimension is measured from top of rail to top of terminal block.</p>								
	1492-JD3				1492-JD4			
	Two-level, Feed-through terminal block							
1492-JD3C				1492-JD4C				
Two-level, Feed-through terminal block with commoning bar								
Standards	UR	CSA	IEC	ATEX	UR	CSA	IEC	ATEX
Voltage rating [V AC/DC]	600	300	400	275	600	300	800	550
Maximum current [A]	20	10	24	21	35	30	32	28
Wire range (rated cross section)	#22... 12 AWG	#26... 12 AWG	2.5 mm ²	2.5 mm ² (#20... 14 AWG)	#26...10 AWG		0.5...4 mm ²	4 mm ² (#20... 12 AWG)
Terminal block	Cat. No.		Pkg. Qty.		Cat. No.		Pkg. Qty.	
Grey	1492-JD3		100		1492-JD4		100	
Color	1492-JD3-⊗		100		1492-JD4-⊗		100	
Grey w/commoning bar	1492-JD3C		100		1492-JD4C		100	
Accessories	Cat. No.		Pkg. Qty.		Cat. No.		Pkg. Qty.	
End barrier	1492-EBJD3		20		1492-EBJD4		20	
Center jumper - 2-pole	1492-CJJ5-2		50		1492-CJLJ6-2		60	
Partition plates	1492-PPJD3		20		1492-PPJD3		20	
Snap-in marker cards	1492-MR5X8		5 cards (120/card)		1492-MR6X8		5 cards (120/card)	
Snap-in marker cards	1492-M5X5		5 cards (200/card)		1492-M6X5		5 cards (200/card)	
Snap-in marker tags for ClearMultiprint	1492-MT5X8		800		1492-MT6X8		600	

⊗ For colored terminal blocks, replace the ⊗ in the catalog number with the following: **RE** = Red, **B** = Blue, **BL** = Black, **G** = Green, **Y** = Yellow, **OR** = Orange, **BR** = Brown, **W** = White, to the end of the catalog number. Multiple pole sizes available.

Terminal Blocks

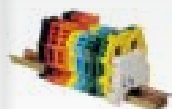

4-2...4-33

Wiring Systems



4-34...4-35

Signal Interface



4-36...4-39

Connection Systems



4-40...4-49

Safety Connection Systems



4-50...4-53

Network Media



4-54...4-61

Product Selection

Grounding Terminal Blocks, Screw Type

<p>Dimensions are not intended to be used for manufacturing purposes</p> <p>Note: Height for dimension is measured from top of rail to top of terminal block.</p>													
		1492-JG3				1492-JG4				1492-JG6			
Standards		UR	CSA	IEC	ATEX	UR	CSA	IEC	ATEX	UR	CSA	IEC	ATEX
Wire range (Rated cross section)		#22...12 AWG		2.5 mm ²	2.5 mm ² (#20...14 AWG)	#22...10 AWG		4 mm ²	4 mm ² (#20...12 AWG)	#22...8 AWG		6 mm ²	6 mm ² (#20...10 AWG)
Terminal block	Type	Cat. No.		Pkg. Qty.		Cat. No.		Pkg. Qty.		Cat. No.		Pkg. Qty.	
	Green/Yellow	1492-JG3		100		1492-JG4		100		1492-JG6		50	
End barrier	Yellow	1492-EBJ3-Y		50		Not required		-		Not required		-	
Snap-in markers		1492-MR5X12 (120/card)		5		1492-MR6X12 (120/card)		5		1492-MR8X12 (84/card)		5	
Snap-in marker tags for ClearMultiPrint		1492-MT5X12		800		1492-MT6X12		600		1492-MT8X12		500	
<p>Dimensions are not intended to be used for manufacturing purposes</p> <p>Note: Height for dimension is measured from top of rail to top of terminal block.</p>													
		1492-JG10				1492-JG16				1492-JG35			
Standards		UR	CSA	IEC	ATEX	UR	CSA	IEC	ATEX	UR	CSA	IEC	ATEX
Wire range (Rated cross section)		#16...6 AWG		10 mm ²	10 mm ² (#16...8 AWG)	#14...4 AWG		16 mm ²	16 mm ² (#16...6 AWG)	#12...1 AWG	#12...2 AWG	35 mm ²	35 mm ² (#14...2 AWG)
Terminal block	Type	Cat. No.		Pkg. Qty.		Cat. No.		Pkg. Qty.		Cat. No.		Pkg. Qty.	
	Green/Yellow	1492-JG10		50		1492-JG16		50		1492-JG35		25	
End barrier		Not required		-		Not required		-		Not required		-	
Snap-in markers		1492-MR8X12		5 cards (84/card)		1492-MR8X12		5 cards (84/card)		1492-MR8X12		5 cards (84/card)	
Snap-in marker tags for ClearMultiPrint		1492-MT8X12		500		1492-MT8X12		500		1492-MT8X12		500	



Terminal Blocks

Product Selection

Plug-in Style Terminal Blocks, Screw Type

<p>Dimensions are not intended to be used for manufacturing purposes</p> <p>Note: Height for dimension is measured from top of rail to top of terminal block.</p>							
		1492-J3P			1492-JD3P		
Standards		UL	CSA	IEC	UL	CSA	IEC
Voltage rating [V AC/DC]		600	300	500	300		500
Maximum current [A]		20	10	24	20		24
Wire range (Rated cross section)		#30...12 AWG		2.5 mm ²	#24...12 AWG	#30...12 AWG	2.5 mm ²
Terminal Block	Type	Cat. No.		Pkg. Qty.	Cat. No.		Pkg. Qty.
	Grey	1492-J3P		100	1492-J3DP		50
	Red	1492-J3P-RE		100	-		-
End barrier		1492-EBJ3		50	1492-EBJD3P		20
Center jumpers	10-pole	1492-CJLJ5-10		20	1492-CJJ5-10		20
	2-pole	1492-CJLJ5-2		60	1492-CJJ5-2		50
Disconnect plug		1492-DPL		50	1492-DPL		50
Component plug		1492-CPL		50	1492-CPL		50
Without blown fuse indicator		1492-FPK2		20	1492-FPK2		20
10...36V blown fuse indicator		1492-FPK224		20	1492-FPK224		20
35...75V blown fuse indicator		1492-FPK248		20	1492-FPK248		20
60...150V blown fuse indicator		1492-FPK2120		20	1492-FPK2120		20
140...250V blown fuse indicator		1492-FPK2250		20	1492-FPK2250		20
Snap-in marker cards		1492-MR5X12		5 cards (120/card)	1492-M5X5		5 cards (200/card)
Snap-in marker cards	1492-M5X5		5 cards (200/card)	1492-MS5X10		5 cards (144/card)	
Snap-in marker tags for ClearMultiPrint		1492-MT5X12		800	1492-MT5X5		800

Terminal Blocks

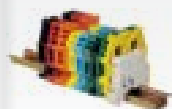

4-2...4-33

Wiring Systems



4-34...4-35

Signal Interface



4-36...4-39

Connection Systems



4-40...4-49

Safety Connection Systems

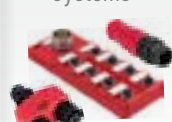

4-50...4-53

Network Media



4-54...4-61



Product Selection

Fuse Blocks, Screw Type

<p>Dimensions are not intended to be used for manufacturing purposes</p> <p>Note: Height for dimension is measured from top of rail to top of terminal block.</p>							
		1492-H...		1492-WFB4...		1492-JD3FB/-JDG3FB	
Specifications		Single-circuit fusible terminal block with or without fuse indication (1/4" x 1-1/4" Fuse)		Single-circuit fuse block with or without fuse indication (5 x 20 mm Fuse)		2-Level fuse block with or without ground connection (5 x 20 mm Fuse)	
Standards		UR	CSA	IEC	UR	CSA	IEC
Voltage rating	H6/WFB4/JD3FB/JDG3FB	300V AC/DC		500V AC/DC		300V AC/DC	
	H5/WFB424/JD3FB24/JDG3FB24	10...57V AC/DC		10...57V AC/DC		10...36V AC/DC	
	JD3FB48/JDG3FB48	-		-		30...70V AC/DC	
	JD3FB120/JDG3FB120	-		-		60...150V AC/DC	
	H4/WFB4250/JD3FB250/JDG3FB250	100...300V AC		85...264V AC		100...250V AC/DC	
Maximum current [A]		15		15	15 *	-	
Fuse circuit		-		-		10 A	10 A/250V AC/DC
Feed-through circuit		-		-		20 A	25 A/300V AC/DC
Wire range (rated cross section)		#30...12 AWG	0.5...4 mm ²	#30...12 AWG	0.5...4 mm ²	#22...12 AWG	#26...12 AWG
Terminal block		Cat. No.	Pkg. Qty.	Cat. No.	Pkg. Qty.	Cat. No.	Pkg. Qty.
Black (non-indicating)		1492-H6	25	1492-WFB4	50	-	-
Grey (non-indicating) 2-level without ground		-	-	-	-	1492-JD3FB	50
Grey (non-indicating) 2-level with Ground		-	-	-	-	1492-JDG3FB	50
Black with blown fuse indication (10...57V AC/DC)		1492-H5	25	1492-WFB424	50	-	-
Black with blown fuse indication (100...300V AC/DC)		1492-H4	25	1492-WFB4250	50	-	-
Accessories		Cat. No.	Pkg. Qty.	Cat. No.	Pkg. Qty.	Cat. No.	Pkg. Qty.
End barrier		1492-N37	50	Not required	-	1492-EBJD3FB	20
Marker card for base block		1492-MS8X12	5 (56/card)	1492-MS8X12	5 (56/card)	1492-M6X5	5 (200/card)
		1492-MS8X9	5 (56/card)	1492-MS8X9	5 (56/card)	-	-
Marker card for handle		1492-MS8X12	5 (56/card)	1492-MS8X9	5 (56/card)	1492-M7X12	5 (108/card)

* IEC standards for 5 x 20 mm fuses do not include rating above 6.3 A.



Terminal Blocks

Product Selection

Sensor Terminal Blocks, Screw Type

<p>Dimensions are not intended to be used for manufacturing purposes.</p> <p>Note: Height for dimension is measured from top of rail to top of terminal block.</p>							
		<p>1492-WTF3</p>			<p>1492-WTS3</p>		
Standards		UL	CSA	IEC	UL	CSA	IEC
Voltage rating [V AC/DC]		300		250	300		250
Maximum current [A]		10		24	10		24
Wire range (rated cross section)		#26...14 AWG		0.5...2.5 mm ²	#26...14 AWG		0.5...2.5 mm ²
Terminal block	Type	Cat. No.		Pkg. Qty.	Cat. No.		Pkg. Qty.
	Grey	1492-WTF3		50	1492-WTS3		50
	Blue	-		-	1492-WTS3-B		50
	Grey for PNP devices	1492-WTF3LP		50	1492-WTS3LP		50
	Grey for NPN devices	1492-WTF3LN		50	1492-WTS3LN		50
End barrier		1492-EBTF3		50	1492-EBTS3		50
Center jumpers	50-pole	1492-CJT5-50		5	1492-CJT5-50		5
	10-pole	1492-CJT5-10		10	1492-CJT5-10		10
	3-pole	1492-CJT5-3		10	1492-CJT5-3		10
	2-pole	1492-CJT5-2		10	1492-CJT5-2		10
Partition plate		1492-PPTS3		50	1492-PPTS3		50
Snap-in marker cards		1492-MS5X9		5 cards (80/card)	1492-MS5X9		5 cards (80/card)

Terminal Blocks

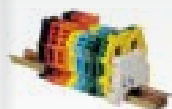

4-2...4-33

Wiring Systems



4-34...4-35

Signal Interface



4-36...4-39

Connection Systems



4-40...4-49

Safety Connection Systems



4-50...4-53

Network Media



4-54...4-61

Product Selection

Standard Feed-through Terminal Blocks, Spring Clamp

<p>Dimensions are not intended to be used for manufacturing purposes</p> <p>Note: Height for dimension is measured from top of rail to top of terminal block.</p>												
	1492-L2				1492-L3				1492-L4			
Standards	UR	CSA	IEC	ATEX	UR	CSA	IEC	ATEX	UR	CSA	IEC	ATEX
Voltage rating [V AC/DC]	300		500	550	600		800	550	600		800	550
Maximum current [A]	15	20	17.5	15	25	27	24	21	33	35	32	28
Wire range (rated cross section)	#26...14 AWG		1.5 mm ²	1.5 mm ² (#20...16 AWG)	#26...12 AWG	#26...12 AWG	2.5 mm ²	2.5 mm ² (#20...12 AWG)	#26...10 AWG		4 mm ²	4 mm ² (#20...10 AWG)
Terminal block	Cat. No.		Pkg. Qty.		Cat. No.		Pkg. Qty.		Cat. No.		Pkg. Qty.	
Grey	1492-L2		50		1492-L3 †		100		1492-L4 †		50	
Color	1492-L2-⊗		50		1492-L3-⊗		100		1492-L4-⊗		50	
Accessories ¹	Cat. No.		Pkg. Qty.		Cat. No.		Pkg. Qty.		Cat. No.		Pkg. Qty.	
End barrier (Grey)	1492-EBL2		50		1492-EBL3 *		50		1492-EBL4 *		50	
Plug-in center jumper 2-pole	1492-CJL4-2		60		1492-CJK5-2		60		1492-CJK6-2		60	
Marker card (edge marking)	1492-M3X5		5 cards (120/card)		1492-M5X10		5 cards (144/card)		1492-M6X10		5 cards (120/card)	
Marker card (center marking)	1492-M3X12		5 cards (200/card)		1492-MR5X8		5 cards (200/card)		1492-M6X5		5 cards (200/card)	
Snap-in marker tags for ClearMultiPrint	1492-MT3X12		1000		1492-MT5X8		800		1492-MT6X8		600	

⊗ For colored terminal blocks, replace the ⊗ in the catalog number with the following: **RE** = Red, **B** = Blue, **BL** = Black, **G** = Green, **Y** = Yellow, **OR** = Orange, **BR** = Brown, **W** = White, to the end of the catalog number.

† For blocks with 1-in and 2-out, add a **T** after the L3 or L4. For blocks with 2-in and 2-out a **Q** after the L3 or L4. Example: catalog number 1492-L3T, 1492-L4Q, 1492-L3T-RE, 1492-L4Q-BL.

* You must also add a **T** or **Q** to the end barrier part number when using 3 or 4 connection terminal blocks.

Example: The end barrier for Bulletin 1492-L3T is catalog number 1492-EBL3T. For the Bulletin 1492-L2Q, the end barrier is catalog number 1492-EBL2Q.

¹ Multiple pole sizes available.



Terminal Blocks

Product Selection

Standard Feed-through Terminal Blocks, Spring Clamp

<p>Dimensions are not intended to be used for manufacturing purposes</p> <p>Note: Height for dimension is measured from top of rail to top of terminal block.</p>								
	<p style="text-align: center;">1492-L6</p>				<p style="text-align: center;">1492-L10</p>			
Standards	UR	CSA	IEC	ATEX	UR	CSA	IEC	ATEX
Voltage rating [V AC/DC]	600		800	550	600		800	550
Maximum current [A]	50		41	36	60	55	57	50
Wire range (rated cross section)	#22...8 AWG	#20...8 AWG	6 mm ²	6 mm ² (#20...8 AWG)	#16...6 AWG		10 mm ²	10 mm ² (#16...8 AWG)
Terminal block	Cat. No.		Pkg. Qty.		Cat. No.		Pkg. Qty.	
Grey	1492-L6 †		50		1492-L10		25	
Color	1492-L6-⊗		50		1492-L10-⊗		25	
Accessories	Cat. No.		Pkg. Qty.		Cat. No.		Pkg. Qty.	
End barrier (grey)	1492-EBL6 *		50		1492-EBL10		50	
Plug-in center jumper 2-pole	1492-CJL8-2		60		1492-CJL10-2		60	
Marking systems: marker card (corner marking)	1492-MR8X12		5 cards (84/card)		1492-MR8X12		5 cards (84/card)	
Marker card (center marking)	1492-M8X5		5 cards (160/card)		1492-M8X5		5 cards (160/card)	
Snap-in marker tags for ClearMultiprint	1492-MT8X12		500		1492-MT8X12		500	
<p>Dimensions are not intended to be used for manufacturing purposes</p> <p>Note: Height for dimension is measured from top of rail to top of terminal block.</p>								
	<p style="text-align: center;">1492-L16</p>				<p style="text-align: center;">1492-L35</p>			
Standards	UR	CSA	IEC	ATEX	UR	CSA	IEC	ATEX
Voltage rating [V AC/DC]	600		800	550	600		800	690
Maximum current [A]	65		76	66	120		125	109
Wire range (rated cross section)	#14...4 AWG		16 mm ²	16 mm ² (#16...6 AWG)	#12...2 AWG		35 mm ²	35 mm ² (#14...2 AWG)
Terminal block	Cat. No.		Pkg. Qty.		Cat. No.		Pkg. Qty.	
Grey	1492-L16		25		1492-L35		10	
Color	1492-L16-⊗		25		1492-L35-⊗		25	
Accessories	Cat. No.		Pkg. Qty.		Cat. No.		Pkg. Qty.	
End barrier (grey)	1492-EBL16		20		Not required		-	
Plug-in center jumper 2-pole								
Marker card (edge marking)	1492-MR8X12		5 cards (84/card)		1492-MR8X12		5 cards (84/card)	
Marker card (center marking)	1492-M8X5		5 cards (160/card)		1492-M8X5		5 cards (160/card)	
Snap-in marker tags for ClearMultiprint	1492-MT8X12		500		1492-MT8X12		500	

⊗ For colored terminal blocks, replace the ⊗ in the catalog number with the following: **RE** = Red, **B** = Blue, **BL** = Black, **G** = Green, **Y** = Yellow, **OR** = Orange, **BR** = Brown, **W** = White, to the end of the catalog number.

† For blocks with 1-in and 2-out, add a T after the L6. Example: catalog number 1492-L6T, 1492-L6T-BR.

* You must add a T to the end barrier catalog number when selecting the end barrier for catalog number 1492-L6T. Example: catalog number 1492-EBL6T.

Terminal Blocks

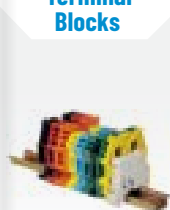

4-2...4-33

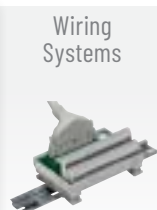

4-34...4-35



4-36...4-39

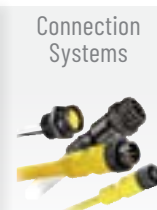

4-40...4-49



4-50...4-53



4-54...4-61

Product Selection

Multi-circuit Feed-through Terminal Blocks, Spring Clamp

<p>Dimensions are not intended to be used for manufacturing purposes</p> <p>Note: Height for dimension is measured from top of rail to top of terminal block.</p>												
	1492-LD3				1492-LD4				1492-LTF3			
Specifications	Two-circuit feed-through terminal block (LD3)				Two-circuit feed-through terminal block (LD4)				Three-circuit feed-through terminal block with optional cross-connection links to common multiple levels			
	Two-circuit feed-through terminal block with commoning bar (LD3C)				Two-circuit feed-through terminal block with commoning bar (LD4C)							
Standards	UR	CSA	IEC	ATEX	UR	CSA	IEC	ATEX	UR	CSA	IEC	ATEX
Voltage rating [V AC/DC]	600		800	550	600		800		300		500	
Maximum current [A]	20	25	24	20	25	30	32		15		20	
Wire range (rated cross section)	#30...12 AWG		2.5 mm ²	0.5...2.5 mm ² (#20...14 AWG)	#26...10 AWG		4 mm ²		#26...12 AWG		0.5...2.5 mm ²	
Terminal block	Cat. No.		Pkg. Qty.		Cat. No.		Pkg. Qty.		Cat. No.		Pkg. Qty.	
Two-circuit feed-through	Grey	1492-LD3	25		1492-LD4	20		-		-		
	Color	1492-LD3-⊗	25		1492-LD4-⊗	20		-		-		
Two-circuit block with commoning bar	Grey	1492-LD3C	25		1492-LD4C	20		-		-		
Three-circuit feed-through block with commoning link	-		-		-		-		1492-LTF3	25		
Accessories	Cat. No.		Pkg. Qty.		Cat. No.		Pkg. Qty.		Cat. No.		Pkg. Qty.	
End barrier (grey)	1492-EBLD3		20		1492-EBLD4		20		1492-EBLTF3		20	
Plug-in center jumper 10-pole	1492-CJK5-10		20		1492-CJK6-10		20		1492-CJK5-10		20	
Plug-in center jumper 2-pole	1492-CJK5-2		60		1492-CJK6-2		60		1492-CJK5-2		60	
Vertical cross connector	-		-		-		-		1492-CJL5D		20	
Marker card	1492-M5X10		5 cards (144/card)		1492-M6X10		5 cards (120/card)		1492-M5X5		5 cards (200/card)	
Snap-in marker tags for ClearMultiprint	1492-MT5X8		800		1492-MT6X8		600		1492-MT5X5		800	

⊗ For colored terminal blocks, replace the ⊗ in the catalog number with the following: **RE** = Red, **B** = Blue, **BL** = Black, **G** = Green, **Y** = Yellow, **OR** = Orange, **BR** = Brown, **W** = White, to the end of the catalog number.



Terminal Blocks

Product Selection

Sensor Terminal Blocks, Spring Clamp

<p>Dimensions are not intended to be used for manufacturing purposes</p> <p>Note: Height for dimension is measured from top of rail to top of terminal block.</p>										
		1492-LS2-3/-LS2-4		1492-LSG2-3/-LSG2-4		1492-LS2-B/-LS2-BR/-LSG2				
Standards		UR	CSA	IEC	UR	CSA	IEC	UR	CSA	IEC
Voltage rating [V AC/DC]		300		250	300		250	300		250
Maximum current [A]		10		17.5	10		17.5	10		17.5
Wire range (rated cross section)		#26...14 AWG		1.5 mm ²	#26...14 AWG		0.5...1.5 mm ²	#26...14 AWG		1.5 mm ²
Terminal block	Color	Cat. No.	Pkg. Qty.	Cat. No.	Pkg. Qty.	Cat. No.	Pkg. Qty.	Cat. No.	Pkg. Qty.	
3-Conductor	Grey	1492-LS2-3	50	-	-	-	-	-	-	
	Green	-	-	1492-LSG2-3	20	-	-	-	-	
3-Conductor led indication	Grey	1492-LS2-3L	50	-	-	-	-	-	-	
4-Conductor	Grey	1492-LS2-4	50	-	-	-	-	-	-	
	Green	-	-	1492-LSG2-4	20	-	-	-	-	
4-Conductor led indication	Grey	1492-LS2-4L	50	-	-	-	-	-	-	
Self-linking plug-in connection blocks	Blue	-	-	-	-	1492-LS2-B	100	-	-	
	Brown	-	-	-	-	1492-LS2-BR	100	-	-	
	Green	-	-	-	-	1492-LSG2	100	-	-	
Accessories		Cat. No.	Pkg. Qty.	Cat. No.	Pkg. Qty.	Cat. No.	Pkg. Qty.			
End barrier	3-Conductor	1492-EBLS2-3	50	1492-EBLS2-3	50	Not required	-			
	4-Conductor	1492-EBLS2-4	50	1492-EBLS2-4	50	Not required	-			
Plug-in center jumper (50-pole)		1492-CJK5-50	10	-	-	-	-			
Plug-in center jumper (10-pole)		1492-CJK5-10	20	-	-	-	-			
Plug-in center jumper (2-pole)		1492-CJK5-2	60	-	-	-	-			
Marker card		1492-MS5X5	5 (200/card)	1492-MS5X5	5 (200/card)	-	-			
Snap-in marker tags for ClearMultiprint		1492-MT5X8	800	1492-MT5X8	800	-	-			

Terminal Blocks

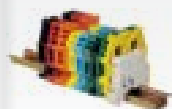

4-2...4-33

Wiring Systems



4-34...4-35

Signal Interface



4-36...4-39

Connection Systems



4-40...4-49

Safety Connection Systems



4-50...4-53

Network Media



4-54...4-61

Product Selection

Grounding Terminal Blocks, Spring Clamp

<p>Dimensions are not intended to be used for manufacturing purposes</p> <p>Note: Height for dimension is measured from top of rail to top of terminal block.</p>												
	1492-LG2			1492-LG3			1492-LG4					
Standards	UR	CSA	IEC	ATEX	UR	CSA	IEC	ATEX	UR	CSA	IEC	ATEX
Wire range (rated cross section)	#26...14 AWG		0.5... 1.5 mm ²	0.5... 1.5 mm ² (#20... 16 AWG)	#30...12 AWG	#26...12 AWG	2.5 mm ²	2.5 mm ² (#20... 12 AWG)	#26...10 AWG		4 mm ²	4 mm ² (#20... 10 AWG)
Maximum current	Grounding			Grounding			Grounding					
Terminal block	Cat. No.		Pkg. Qty.		Cat. No.		Pkg. Qty.		Cat. No.		Pkg. Qty.	
Green/Yellow	1492-LG2		50		1492-LG3 †		50		1492-LG4 †		50	
Accessories	Cat. No.		Pkg. Qty.		Cat. No.		Pkg. Qty.		Cat. No.		Pkg. Qty.	
End barrier (yellow)	1492-EBL2-Y		50		1492-EBL3-Y ^ø		50		1492-EBL4-Y ^ø		50	
Marker card (edge marking)	1492-M3X12		5 cards (120/card)		1492-M5X10		5 cards (144/card)		1492-M6X10		5 cards (120/card)	
Marker card (center marking)	1492-M3X5		5 cards (100/card)		1492-MR5X8		5 cards (120/card)		1492-MR6X8		5 cards (120/card)	
Snap-in marker tags for ClearMultiprint	1492-MT3X8		1000		1492-MT5X8		800		1492-MT6X8		600	

† For blocks with 1-in and 2-out, add a **T** after the LG3 or LG4. For blocks with 2-in and 2-out, add a **Q** after the LG3 or LG4. Example: catalog number 1492-LG3**T**, 1492-LG4**Q**.

ø You must also add a **T** or **Q** to the end barrier part number when using 3 or 4 connection terminal blocks. Example: The end barrier for Bulletin 1492-LG3**T** is catalog number 1492-EBL3**T**-Y. For the Bulletin 1492-LG2**Q**, the end barrier is catalog number 1492-EBL2**Q**-Y.



Need Help?

The Rockwell Automation Support Center is your 24/7 support for the answers you need now.

<https://rok.auto/support>



Terminal Blocks

Product Selection

Grounding Terminal Blocks, Spring Clamp

<p>Dimensions are not intended to be used for manufacturing purposes</p> <p>Note: Height for dimension is measured from top of rail to top of terminal block.</p>								
	1492-LG6				1492-LG10			
Standards	UR	CSA	IEC	ATEX	UR	CSA	IEC	ATEX
Voltage rating [V AC/DC]	-							
Maximum current	Grounding				Grounding			
Wire range (rated cross section)	#22...8 AWG	#20...8 AWG	6 mm ²	6 mm ² (#20...8 AWG)	#16...6 AWG	10 mm ²	10 mm ² (#16...8 AWG)	
Terminal block	Cat. No.		Pkg. Qty.		Cat. No.		Pkg. Qty.	
Green/Yellow	1492-LG6 †		50		1492-LG10		25	
Accessories	Cat. No.		Pkg. Qty.		Cat. No.		Pkg. Qty.	
End barrier (yellow)	1492-EBL6-Y *		50		1492-EBL10-Y		20	
Marker card (edge marking)	1492-MR8X12		5 cards (84/card)		1492-MR8X12		5 cards (84/card)	
Marker card (center marking)	1492-M8X5		5 cards (160/card)		1492-M8X5		5 cards (160/card)	
Snap-in marker tags for ClearMultiprint	1492-MT8X12		500		1492-MT8X12		500	

<p>Dimensions are not intended to be used for manufacturing purposes</p> <p>Note: Height for dimension is measured from top of rail to top of terminal block.</p>								
	1492-LG16				1492-LG35			
Standards	UR	CSA	IEC	ATEX	UR	CSA	IEC	ATEX
Voltage rating [V AC/DC]	-							
Maximum current	Grounding				Grounding			
Wire range (rated cross section)	#14...6 AWG	#14...4 AWG	16 mm ²	16 mm ² (#16...6 AWG)	#12...2 AWG	35 mm ²	35 mm ² (#14...2 AWG)	
Terminal block	Cat. No.		Pkg. Qty.		Cat. No.		Pkg. Qty.	
Green/Yellow	1492-LG16 †		25		1492-LG35		10	
Accessories	Cat. No.		Pkg. Qty.		Cat. No.		Pkg. Qty.	
End barrier (yellow)	1492-EBL16-Y		20		Not required		-	
Marker card (edge marking)	1492-MR8X12		5 cards (84/card)		1492-MR8X12		5 cards (84/card)	
Marker card (center marking)	1492-M8X5		5 cards (160/card)		1492-M8X5		5 cards (160/card)	
Snap-in marker tags for ClearMultiprint	1492-MT8X12		500		1492-MT8X12		500	

† For blocks with 1-in and 2-out, add a **T** after the LG6. Example: catalog number 1492-LG6T.

⊗ You must also add a **T** to the end barrier catalog number when selecting the end barrier for catalog number 1492-LG6T. Example: catalog number 1492-EBL6T-Y.

Terminal Blocks

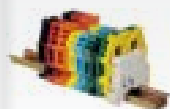

4-2...4-33

Wiring Systems



4-34...4-35

Signal Interface



4-36...4-39

Connection Systems



4-40...4-49

Safety Connection Systems



4-50...4-53

Network Media



4-54...4-61

Product Selection

Isolation & Plug-in Terminal Blocks, Spring Clamp

<p>Dimensions are not intended to be used for manufacturing purposes</p> <p>Note: Height for dimension is measured from top of rail to top of terminal block.</p>								
	1492-LKD3				1492-L3P			
Standards	UR	CSA	IEC	ATEX	UR	CSA	IEC	ATEX
Voltage rating [V AC/DC]	600		500		600		500	
Maximum current [A]	20		24		20		24	
Wire range (rated cross section)	#30...12 AWG		2.5 mm ²		#30...12 AWG		4 mm ²	
Terminal block								
Grey	1492-LKD3		25		1492-L3P		25	
Accessories	Cat. No.		Pkg. Qty.		Cat. No.		Pkg. Qty.	
End barrier (grey)	1492-EBL3		50		1492-EBL3		50	
Plug-in center jumper (10-pole)	1492-CJK5-10		20		1492-CJK5-10		20	
Plug-in center jumper (2-pole)	1492-CJK5-2		60		1492-CJK5-2		60	
Fuse plug non-indicating	-		-		1492-FPK2		20	
10...36V LED	-		-		1492-FPK224		20	
35...70V LED	-		-		1492-FPK248		20	
60...150V LED	-		-		1492-FPK2120		20	
140...250V LED	-		-		1492-FPK2250		20	
Disconnect plug	-		-		1492-DPL		50	
Component plug	-		-		1492-CPL		50	
Snap-in marker cards	1492-MR5X8		5 cards (120/card)		1492-MR5X8		5 cards (120/card)	
Snap-in marker tags for ClearMultiport	1492-MT5X8		800		1492-MT5X8		800	



Terminal Blocks

Product Selection

Fuse Blocks, Spring Clamp

<p>Dimensions are not intended to be used for manufacturing purposes.</p> <p>Note: Height for dimension is measured from top of rail to top of terminal block.</p>								
		1492-RFB4...		1492-RAFB4...		1492-LAFB6...		
Specifications		Single-circuit fuse terminal block with or without fuse indication (5...20 mm Fuse)		Single-circuit fuse terminal block with or without fuse indication (1/4 x 1-1/4" Fuse)		Automotive style fuse block		
Standards		UR	CSA	IEC	UR	CSA	IEC	
Voltage rating	RFB4/RAFB4/LAFB6	300V AC/DC		500V AC/DC		300V AC/DC		250V AC/DC
	RFB424/RAFB424/LAFB624	10...57V AC/DC		10...57V AC/DC		10...36V AC/DC		
	RFB4250/RAFB4250	85...264V AC		85...264V AC		-		
Leakage current	RFB424/RAFB424/LAFB624	2 mA @ 24V		2 mA @ 24V		2 mA @ 24V		
	RFB4250/RAFB4250	1 mA @ 264V		1 mA @ 264V		-		
Maximum current [A]		15 *		15		30	25	30
Wire range (rated cross section)		#22...12 AWG	0.5...4 mm ²	#22...12 AWG	0.5...4 mm ²	#22...12 AWG	#22...10 AWG	0.5...6 mm ²
Terminal block								
Black (non-indicating)		1492-RFB4	25	1492-RAFB4	25	1492-LAFB6	25	
Black with blown fuse indication (10...57V AC/DC)		1492-RFB424	25	1492-RAFB424	25	1492-LAFB624	25	
Black with blown fuse indication (85...264V AC/DC)		1492-RFB4250	25	1492-RAFB4250	25	-	-	
Accessories		Cat. No.	Pkg. Qty.	Cat. No.	Pkg. Qty.	Cat. No.	Pkg. Qty.	
Plug-in center jumper (10-pole)		1492-CJR8-10	10	-	-	1492-CJL8-32 (32-pole)	10	
Plug-in center jumper (2-pole)		1492-CJR8-2	20	1492-CJRA10-2	10	1492-CJL8-2	60	
Center jumper link		1492-CJRL6	60	1492-CJRL5	10	-	-	
Marker card for base block		1492-MS8X12	5 (56/card)	1492-MS8X12	5 (56/card)	1492-M5X8	5 (144/card)	
Marker card for handle		1492-MS6X9	5 (80/card)	1492-MS6X9	5 (80/card)	-	-	

* IEC standards for 5 x 20 mm fuses do not include ratings above 6.3 A.

Terminal Blocks



4-2...4-33

Wiring Systems

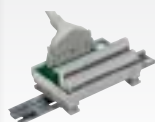

4-34...4-35

Signal Interface



4-36...4-39

Connection Systems



4-40...4-49

Safety Connection Systems



4-50...4-53

Network Media



4-54...4-61



Accessories

End Anchors and End Retainers

	Dimensions (W x L x H)	Tightening Torque	Markers	Used With	Color	Pkg. Qty.	Cat. No
	0.31 x 2.20 x 1.85 in. (8 x 56 x 47 mm)	4.4 lb•in (0.5 N•m)	1492-GM5X30 1492-M7X12 1492-M8X5	199-DR1, 199-DR2, 1492-DR4, 1492-DR5, 1492-DR6, 1492-DR7, 1492-DR8, 1492-DR9	Grey	100	1492-EAJ35
	0.48 x 2.20 x 2.48 in. (12.2 x 56 x 63 mm)	7.0 lb•in (0.8 N•m)	1492-M7X12 1492-M5X5	199-DR1, 199-DR2, 1492-DR4, 1492-DR5, 1492-DR6, 1492-DR7, 1492-DR8, 1492-DR9	Grey	50	1492-EAHJ35
	0.24 x 2.19 x 1.63 in. (6 x 55.6 x 41.5 mm)	-	1492-GM5X30 1492-M5X10 1492-M5X5	199-DR1, 199-DR2, 1492-DR4, 1492-DR5, 1492-DR6, 1492-DR7, 1492-DR8, 1492-DR9	Grey	20	1492-ERL35
	0.31 x 2.28 x 1.42 in. (8 x 58 x 36 mm)	5.3 lb•in (0.6 N•m)	1492-GM5X30 1492-MT8X8	199-DR1, 199-DR2, 1492-DR4, 1492-DR5, 1492-DR6, 1492-DR7, 1492-DR8, 1492-DR9	Grey	50	1492-EAP35

DIN Mounting Rails

	Description	Pkg. Qty.	Cat. No
	Symmetrical rail 35 x 7.5 mm 3.28 ft (1 m) long Zinc-plated Chromated steel EN60715 Din#3	10	199-DR1
	Symmetrical rail 35 x 7.5 mm 6.56 ft (2 m) long Zinc-Plated Chromated steel EN60715 Din#3	20	199-DR2
	Raised symmetrical rail 35 x 7.5 mm 2.26 in. (57.4 mm) high 3.28 ft (1 m) long Copper-free Aluminum Din#3	2	1492-DR6
	Angled symmetrical rail 35 x 7.5 mm 2.80 in. (71.0 mm) high 3.28 ft (1 m) long Angled 30° Zinc-plated Chromated steel Din#3	2	1492-DR7

For accessory options, please visit
<https://rok.auto/directory>



Terminal Blocks

Terminal Block Marking Systems 1492

- Choose from two marking system technologies
- ClearMultiprint™ for cost sensitive applications using spool format marker tags
- ClearPlot™ for high quality applications using card format marker tags



ClearMultiprint™ Marking System

The ClearMultiprint marking system provides high-quality spool media printing in an easy-to-use format for all users.

- Thermal transfer technology eliminates ink dry out issues
- Less than a minute to print and set a full row of marker cards
- Provides high contrast on white marker tags and wire labels
- Wide range of print media: terminal block tags, wire and cable labeling, heat shrink, and adhesive device markers



ClearPlot™ Marking System

The ClearPlot marking system provides high-quality printing for low to medium volume users on terminal block marker cards.

- Plot partial marker cards
- Load up to three marker cards at a time (mix and match)
- Character customization
- Extensive marker card library offers optimal flexibility

ClearTools™ Software

Free ClearTools software makes it easy to create everything from basic numbering and sequences to images. You can import from a variety of file formats or use the included library of symbols.

Terminal Blocks

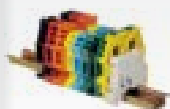

4-2...4-33

Wiring Systems



4-34...4-35

Signal Interface



4-36...4-39

Connection Systems



4-40...4-49

Safety Connection Systems



4-50...4-53

Network Media



4-54...4-61

Product Selection

Marking Systems

Marking System	Cat. No
ClearMultiPrint™	1492-PRINTCMP
ClearPlot™ Basic	1492-PL0TBSC



Marker Tags for ClearMultiPrint

Catalog	Used With	Markers Per Roll	Size
1492-MT3X5	1492-L	1000	3mm x 5mm
1492-MT5X5	1492-J,L	800	5mm x 5mm
1492-MT6X5	1492-J,L	600	6mm x 5mm
1492-MT8X5	1492-J,L	500	8mm x 5mm
1492-MT3X12	1492-L	1000	3mm x 12mm
1492-MT5X12	1492-J,L	800	5mm x 12mm
1492-MT6X12	1492-J,L and 1738 ArmorPoint	600	6mm x 12mm
1492-MT8X12	1492-J,L	500	8mm x 12mm
1492-MT3X8	1492	1000	3mm x 8mm
1492-MT5X8	1492-J,L	800	5mm x 8mm
1492-MT6X8	1492-J,L	600	6mm x 8mm
1492-MT8X8	1492	500	8mm x 8mm
1492-GM8X30	1492-EAJ35, 1492-ERL35	50	8mm x 30mm
1492-MGT6X30	1492-GM8X30, 1492-MWCTC8X30	100	6mm x 30mm
1492-MT5X12-BP	1492-J,L	5500	5mm x 12mm
1492-MT6X12-BP	1492-J,L and 1738 ArmorPoint	4500	6mm x 12mm

Accessories for ClearMultiPrint

Description	Cat. No
Marker Tag Ribbon	1492-PRIBTB
Wire Label & Adhesive Marker Ribbon	1492-PRIBLAB
Heat Shrink Ribbon	1492-PRIBHS
Terminal Block Marker Tag Roller	1492-PROLLTB 1492-PROLLTBW5/6/8X9 1492-PROLLTBW5/6/8X12 1492-PROLLTBCPC 1492-PROLLTBCW
Flat Media Roller	1492-PROLLLAB
External Roll Holder	1492-PEXTRH ¹

¹ 1492-PEXTRH is only needed for the 1492-MT5X12-BP and the 1492-MT6X12-BP big packs.

Selection for additional media types can be found in Product Selection*



Heat shrink



Wire labels



Adhesive device markers

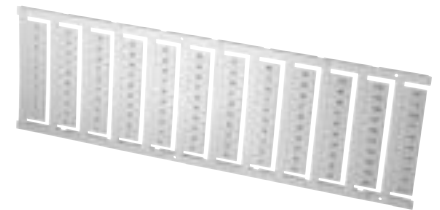

Marker tags

* Marker tags are also available that are compatible with Allen-Bradley 1492-W as well as Phoenix and Wago Terminal blocks. Reference publication 1492-TD016.

For more information on our complete family of terminal block products, please visit:
<https://rok.auto/terminal-blocks>



Terminal Blocks

Power Distribution Blocks 1492-PDE

- IP20 Finger-safe protection
- Power distribution through 510 A
- DIN Rail and panel mountable
- High fault SSCR up to 100 kA



Finger-safe power distribution terminal blocks are designed to prevent accidental contact with live connectors – without the use of additional barriers or shields. These panel mount devices have a compact footprint, and are available with either aluminum or copper terminals. Captive termination screws ensure that parts never get lost and the rugged thermoplastic housing will resist physical damage.

These single-pole devices are available with DIN or panel mount options and can easily be assembled together to create multi-pole solutions.

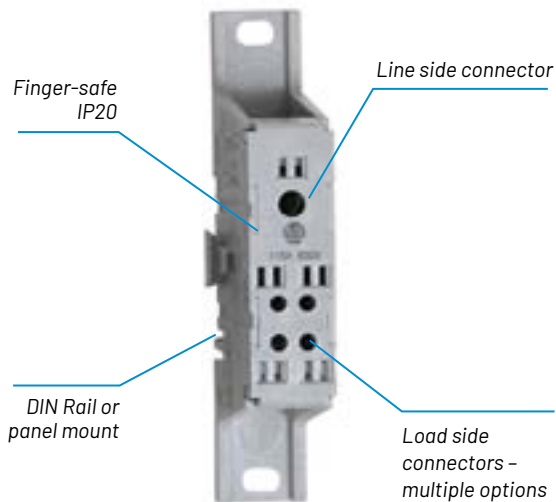

Terminal Blocks



4-2...4-33

Wiring Systems



4-34...4-35

Signal Interface



4-36...4-39

Connection Systems



4-40...4-49

Safety Connection Systems



4-50...4-53

Network Media



4-54...4-61

Product Selection

Power Distribution Blocks

Amps (Cu Wire) 75° C	No. of Poles	Line			Load			Flexible Copper Wire *	Cat. No.
		Connector Diagram	Wire Range [kcmil / AWG (mm ²)]	Openings per Pole	Connector Diagram	Wire Range [kcmil / AWG (mm ²)]	Openings per Pole		
115			#2...#14 (35...2.5)	1		#2...#14 (35...2.5) †	1	Yes	1492-PDME1111 [⊖]
						#10...#14 (6...2.5) [⊖]	4	Yes	1492-PDME1141 [⊖]
200	1-pole		2/0...#14 (70...2.5)	1		2/0...#14 (70...2.5)	1	Yes	1492-PDE1112 [⊖]
						#2...#14 (35...2.5) †	4	Yes	1492-PDE1142 [⊖]
510			250 ... #6 (120...16)	2		250...#6 (120...16)	2	Yes (line side)	1492-PDE1225
									1492-PDE1C255 ^Δ
335			(1) 400...#6 (185...16) (1) 2/0...#14 (70...2.5)	1		#2...#14 (35...2.5) †	8	Yes (line side)	1492-PDE1183
									1492-PDE1C183 ^Δ

† Wire openings rated for #2-14 AWG are multiple wire rated: (2) #6 CU Str, (2) #8 CU Str, (2-4) #10 CU Str, (2 to 4) #12 CU Str, and (2 to 4) #14 CU Str.

⊖ Wire openings rated for #2/0-14 AWG are multiple wire rated: (2) #4 CU Str, (2) #6 CU Str, (2) #8 CU Str, (2) #10 CU Str, (2) #12 CU Str.

* Flexible copper wire connections approved for flexible wire, stranding Classes G, H, I, K and DLO wire without the need for additional crimp connectors.

Δ The **C** in the catalog number designates copper terminals. The catalog numbers without the **C**, have aluminum connectors.

⊖ UL 1953 Listed E 313475 Guide QPQS.

Standards Compliance and Certifications

Standards Compliance	UL 1059, UL 1953, CSA C22.2 No. 158, EN/IEC 60947-1, -7-1
Certifications	CE Marked, CSA Certified (File No. 72582, Class 6228-01), UL Component Recognized (File No. E40735, Guide No. XCFR2), UL Listed (File No. E313475, Guide No. QPQS), RoHS
Flammability Ratings	94V-0

For more information on our complete family of terminal block products, please visit:
<https://rok.auto/terminal-blocks>



Wiring Systems

Wiring Systems 1492

- Interface modules (IFM) connect through pre-wired cables to digital and analog I/O
- Simplified design reduces bill of materials – one IFM module and cable replaces multiple terminal blocks, wires and terminations
- Design flexibility – feed-through, LED indication, fusing, and interposing relay IFMs are available to meet application variables



Value Add of Wiring Systems

You can achieve up to 75% savings on your control wiring time and reduce wiring errors when using a Bulletin 1492 Wiring System compared with wiring to traditional terminal blocks.

1492 Wiring Systems

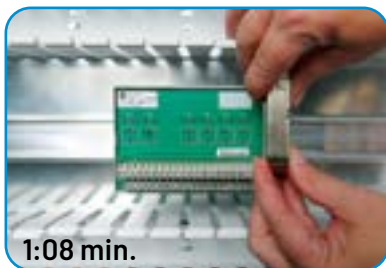

Replace multiple terminal blocks, wires and terminations with single IFM and cable.

Conventional Wiring



Cables:

- Pre-wired
- IFM Ready
- I/O Ready



Interface Modules (IFM):

Digital

- Straight Feed-through
- LED indicating
- Fused
- Relay

Analog

- Straight Feed-through
- Fused
- Specialty



Terminal
Blocks

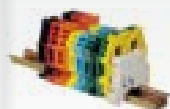

4-2...4-33

Wiring
Systems



4-34...4-35

Signal
Interface



4-36...4-39

Connection
Systems



4-40...4-49

Safety
Connection
Systems



4-50...4-53

Network
Media



4-54...4-61

Wiring systems replace the point-to-point wiring between a PLC I/O module and individual terminal blocks – providing quicker, more accurate connections between control and factory devices.

ControlLogix® Controllers
1756



CompactLogix™ Controllers
1769



MicroLogix™ 1200 Controllers (40 Embedded I/O)
1762

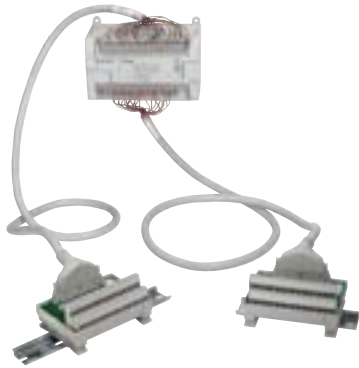

MicroLogix™ 1500 Controllers
1764



Flex™ I/O (with Flex D-Shell Base Modules)
1794



CompactLogix™ L1/L2 (Embedded I/O)
5370



Signal Interface

Signal Conditioners 931 N/S

- Helps protect your expensive control system from transients and noise
- Eliminates ground loop/noise-induced errors in process measurements through high levels of galvanic isolation
- Cost effective signal conversion to solve a signal mismatch between field device and I/O
- Eliminates signal degradation of critical process measurement during transmission



Signal Conditioners are designed for use with I/O systems to provide reduced installation and maintenance costs in process applications. A wide range of products are available for use wherever temperature, pressure, speed, weight, level, and flow are measured and controlled as part of a continuous or batch production process.

A variety of product types are offered to meet your application needs, including:

931N - Nano Series

- Space-saving 6 mm housing
- Easy onboard configuration
- Angled terminals for ease of wiring
- Power rail option reduces supply wiring



931S - Smart Series

- Compact housings 12.5, 17.5, and 22.5 mm wide
- Angled terminals for ease of wiring
- Removable terminals
- Interactive display



Accessories

	Description	DIN Size	Length	Catalog Number
	Kit Contains: • 1 bus circuit layer insert • 1 support section • 1 cover • 1 end left plate • 1 end right plate	35 x 7.5 mm	250 mm	931A-CS
			500 mm	931A-FS
		35 x 15 mm	250 mm	931A-CL
			500 mm	931A-FL

Configuration Cable

Description	Part
USB Cable	931A-CB*

* Assists in the configuration of devices with DTM files.

Terminal Blocks



4-2...4-33

Wiring Systems



4-34...4-35

Signal Interface



4-36...4-39

Connection Systems



4-40...4-49

Safety Connection Systems



4-50...4-53

Network Media



4-54...4-61



Product Selection

931N - Nano Series

Input	Output					
	0...23 mA	0/4...20 mA; 0/1/2...5/10 V (Configurable)	4...20 mA; 20...4 mA	± 10 mA, ± 20 mA	Channel	Power
0...23 mA	931N -C121				1	24V DC
	931N -C122				Splitter	24V DC
	931N -C141				1	Input Loop
	931N -C144				2	Input Loop
	931N -C161				1	Output Loop
	931N -C164				2	Output Loop
0/4...20 mA; 0/1/2...5/10V (Configurable)		931N -A221			1	24V DC
		931N -A222			Splitter	24V DC
± 10/± 20 mA, ±10 V (Configurable)		931N -X221			1	24V DC
		931N -X422		931N -X422	Splitter	24V DC
Thermocouple J, K		931N -T221			1	24V DC
PT100			931N -R161		1	Output Loop
		931N -R221			1	24V DC
Thermocouple J, K; PT100			931N -N161		1	Output Loop
Universal (All Thermocouples, PT RTDs, Potentiometer, Resistance, Current, Voltage)		931N -U221			1	24V DC

931S - Smart Series

Input	Output									
	0...22 mA, 0...11 V (Config small measurement ranges, 4mA/2V)	0/4...20 mA; 0/1/2...5/10 V (Configurable)	0/4...20 mA with HART	0/2...10 V	0/4...20 mA, ± 20 mA, 0/1/2...5/10 V, ± 5/10 V	Relay	Relay; 0/4...20 mA, ± 20 mA, 0/1/2...5/10 V, ± 5/10 V	0/4...20 mA, Transistor	Channels	Power
0...22 mA, 0...11 V (Config small meas. ranges, 4mA/2V)	931S-A481								1	12...60V DC
Load Cell/Bridge ± 10 mV, ± 20 mV, ± 30 mV, ± 50 mV		931S-B481							1	10...60V DC
0/4...20 mA with HART			931S-C121						1	24V DC
			931S-C122					Splitter		
			931S-C124					2		
0/4...20 mA				931S-C221					1	24V DC
0...1/5/10 A AC or DC					931S-L521				1	24V DC
0...40/50/60 A AC or DC						931S-M321			1	24V DC
0...5/10 A AC or DC							931S-M5211		Splitter	24V DC
0...20/25/30 A AC or DC							931S-M5213		Splitter	24V DC
0...40/50/60 A AC or DC							931S-M5216		Splitter	24V DC
PT100, PTC						931S-N392			Splitter	20...264V AC/DC
± 0.1mA...±100 mA, ±20 mV...±300 V					931S-P491				1	24...240V AC/DC
0...660V DC, 0...440V AC		931S-V291							1	24...240V AC/DC
200...480V AC (3Ph)						931S-V342			Splitter	Input Loop Powered
110/240/400V AC/DC						931S-V392			Splitter	24...240V AC/DC
Universal (All Thermocouples, PT/RTDs, Potentiometer, Resistance, Current, Voltage)						931S-U382			Splitter	9...60 V DC
						931S-U392				90...264 V AC
								931S-U561		Output Loop Powered



Signal Interface

Intrinsic Safety Modules 937 Z/T/C

- For analog and digital signals in hazardous locations
- Simple maintenance with integrated diagnostics and quick change of modules during ongoing operation
- Comprehensive standards compliance, including up to SIL3 compliance for easy and reliable planning and documentation
- Horizontal or vertical mounting with no reduction in operational ratings
- Power Rail for drastically reduced wiring, collective error messaging, efficient troubleshooting and installation



Bulletin 937 Intrinsic Safety Modules connect intrinsically safe rated equipment – such as transmitters, solenoids, proximity sensors and encapsulated assemblies – with control systems.

Product Range Overview

- From simple switch amplifiers to highly functional signal converters
- Modules available with galvanic isolation
- Low heat dissipation thanks to low power consumption
- Broad supply voltage range including AC, DC and universal power supply (AC/DC)

Easy Configuration

- DIP switches or Pushbuttons with LCD display
 - FDT Interface between devices and control system

Power Rail System

- Allows simple snap-in of modules
- Power supply and monitoring of lead breakages/short circuit on gold-plates rails
- Reduces wiring
- Vertical and horizontal mounting
- Simplifies future expansions

Compact Size

- 12.5 mm housing allowed for 2 channel densities

Removable Terminals

- Rapid connection
- Up to 2.5mm/14 AWG wiring
 - Keyed terminals eliminate misconnection



Power Feed Module

- Link power supply to the Power Rail
- Group fusing
- Redundancy options
- Alarming for lead breakage, short circuit, and power failure
- Reduces I/O overhead
- Front switch for mode of operation

Signal Interface

Terminal Blocks

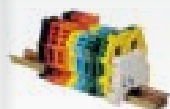

4-2...4-33

Wiring Systems



4-34...4-35



4-36...4-39

Connection Systems



4-40...4-49

Safety Connection Systems



4-50...4-53

Network Media



4-54...4-61

Product Selection

Isolated/Converter Barriers

Module Type	Signal Type	Device Power	Channels	Signal Splitter	Width	Cat. No.
Switch amplifier	Digital input, Transistor output	24V DC	1-channel	Yes	12.5 mm	937TH-DISTS-DC1
			2-channel	No		937TH-DISAT-DC2
			1-channel	Yes		937TH-DISRS-DC1
			2-channel	No		937TH-DISAR-DC2
	Digital input, Relay output	115V AC	1-channel	Yes	20 mm	937TS-DISRS-KD1
			2-channel	No		937TS-DISAR-KD2
		230V AC	1-channel	Yes		937TS-DISRS-KF1
			2-channel	No		937TS-DISAR-KF2
Solenoid driver	Digital output	Input loop powered	1-channel	No	12.5 mm	937TH-DOSND-IP1
SMART transmitter supply	Analog input	24V DC	1-channel	No	12.5 mm	937TH-AITXP-DC1
			1-channel	Yes	12.5 mm	937TH-AITXS-DC1
			2-channel	No	20 mm	937TS-AITXP-DC2
Temperature repeater	Analog input		1-channel	No	12.5 mm	937TH-AIRRP-DC1
				No	12.5 mm	937TH-AOSCD-DC1
SMART current driver	Analog output		1-channel	-	20 mm	937CS-AITMP-DC1 ¹
Universal temp converter	Analog input				40 mm	937CU-AITXF-DC1
Transmitter supply converter	Analog input		937CU-AIHLP-DC1			
HART loop converter	Analog input		937CU-AISTR-DC1			
Strain gauge converter	Analog input		937CU-DIFRQ-DC1			
Frequency converter	Digital input	20-90V DC/48-253 V AC	-	937CU-DIFRQ-BC1		
	Digital input					

¹ Configured via Field Device Tool (FDT) software such as Rockwell Software FactoryTalk AssetCentre or PACTware.

Zener Barriers

Signal Type	Max Resistance	Other Functionality	Channels	Width	Cat. No.
Positive polarity DC	646 Ohm	-	2-channel	12.5 mm	937ZH-DPAN-2
	327 Ohm	-	1-channel		937ZH-DPBN-1
	36 + 0.9V Ohm	Diode return	2-channel		937ZH-DPCD-2
	327 Ohm	-	2-channel		937ZH-DPBN-2
	250 Ohm	Diode return, high power	2-channel		937ZH-DPDP-2

Accessories

Power rail feed module	Power feed module for power rail system	Width: 20 mm	937A-PSFD
Power rail 0.8 meter	Power rail with cover and 2 end caps	Length: 0.8 M	937A-PR08
Power rail 2 meter	Power rail with cover and 2 end caps	Length: 2 M	937A-PR20
Power rail end caps	Power rail end caps	-	937A-PREC
USB interface cable	USB interface programming cable	-	937A-USBA
Cold junction compensation connector	Cold junction compensation for 937CS-AITMP-DC1 (thermocouples)	-	937A-TCJC

For more information on our complete family of signal interface products, please visit:
<https://rok.auto/signal-interface>



Connection Systems

Non-network Connectivity Solutions

Allen-Bradley® passive connectivity components make up a complete plug & play solution that simplifies and consolidates wiring, while providing secure connections for proximity sensors, limit switches, photoelectric sensors, and other field devices.

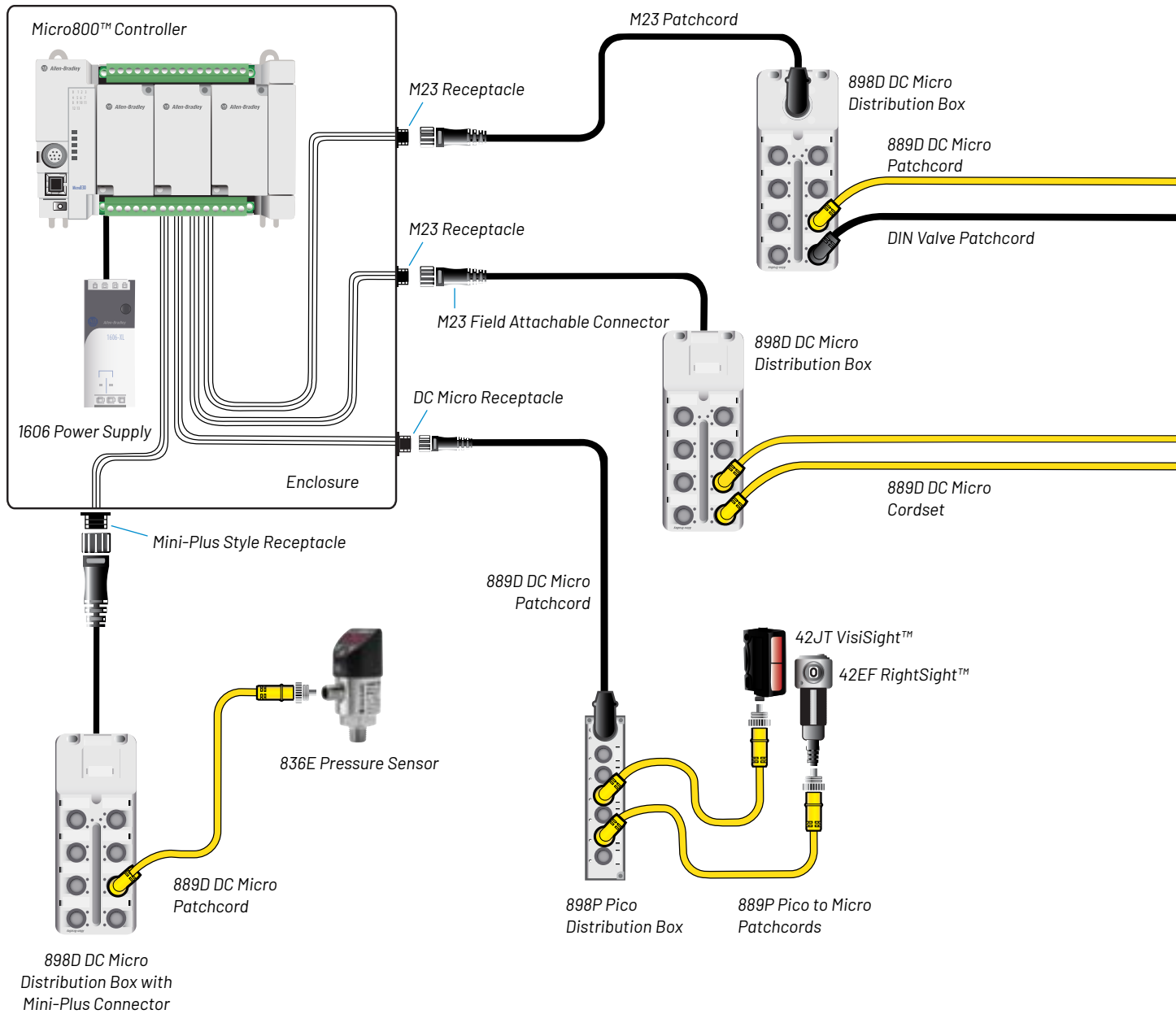

Terminal Blocks



4-2...4-33

Wiring Systems

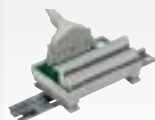

4-34...4-35

Signal Interface



4-36...4-39

Connection Systems



4-40...4-49

Safety Connection Systems



4-50...4-53

Network Media



4-54...4-61

Application

Non-network Connectivity is ideal for compact machines, cost-sensitive applications or those where minimal diagnostics are required.

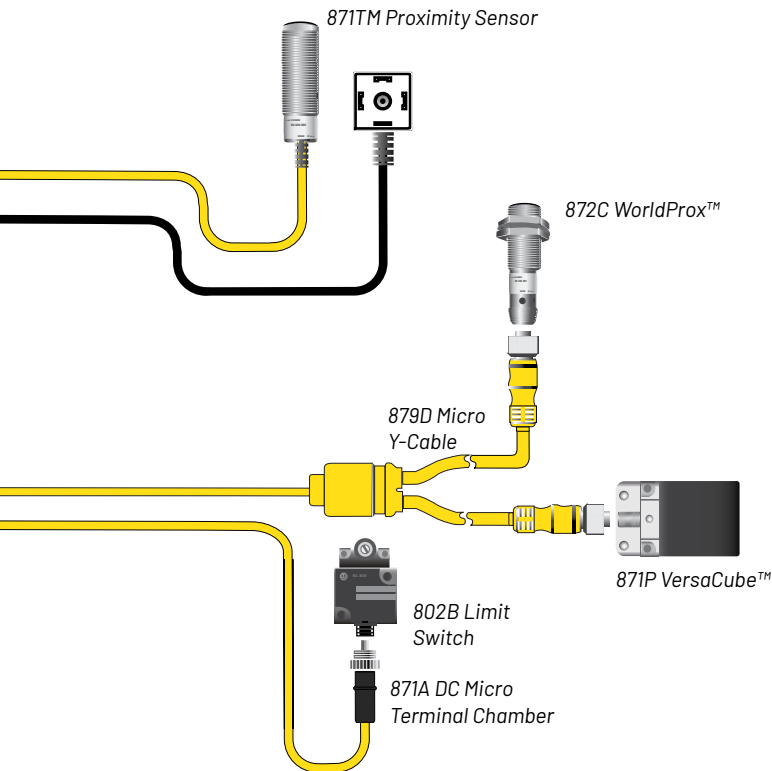

ProposalWorks Proposal Builder

We offer many standard and custom connectivity products not shown in this catalog. Our free ProposalWorks software is the easiest way to select or configure a solution from our wide range of connectivity products.

<https://rok.auto/configure>

A complete connectivity solution, including:

- Cordsets (connector at one end, leads on the other)
- Patchcords (connectors at each end)
- Field-attachable connectors
- Panel-mount receptacles
- Distribution boxes
- Splitters and tees
- V- and Y-cables
- Raw cable spools

Connectivity Styles

- DC micro (M12)
- AC micro (1/2 in.)
- Mini (7/8 in.)
- M23
- Pico
- Mini Plus
- EAC micro
- DIN Valve

Various cable jacket materials, colors, and flex ratings for a wide range of applications and environments:

- PVC – General purpose applications
– Yellow, black, grey, red, or blue
- TPE – Bending and flexing applications, temperature extremes
– Yellow and black
- PUR – Bending and flexing applications, chemical environments, water submersion
– Yellow and black
- ToughWeld™ (CPE) – Welding applications, chemical environments
- ToughLink™ (TPE) – UV and water resistant, chemical environments
- High Flex TPE and PUR – rated to 5 million, 9 million, and 10 million flex cycles



Connection Systems

DC Micro Cordsets & Patchcords 889D

- 4-, 5-, and 8-pin connectors
- Straight or right angle versions
- 22 or 24 AWG cable
- Oil-resistant yellow, black or red PVC jacket



Product Selection

Cordsets

Female (Sensor End) Connector Style	Cable			Cat. No. ^{1,3}	
	Wire Color		Assembly Rating		Length [m (ft)]
4-pin straight	1 Brown 2 White	3 Blue 4 Black	22 AWG 250V, 4 A	1...30m (3.3...98.4 ft)	889DQ-F4AC-*
4-pin straight					889D-F4AC-2
4-pin right angle					889D-R4AC-2
5-pin straight	1 Brown 2 White	3 Blue 4 Black 5 Grey	24 AWG, 30V AC/36V DC, 1.5 A	2 (6.56)	889D-F5AC-2
8-pin straight	1 White 2 Brown 3 Green 4 Yellow	5 Grey 6 Pink 7 Blue 8 Red			889D-F8AB-2 ²

* Quick Connect version

Patchcords

Female (Sensor End) Connector Style	Male (I/O End) Connector Style	Cable		Cat. No. ¹
		Assembly Rating	Length [m (ft)]	
4-pin straight	4-pin straight	22 AWG 250V, 4 A	2 (6.56)	889D-F4ACDM-2
	4-pin right angle			889D-F4ACDE-2
4-pin right angle	4-pin straight			889D-R4ACDM-2
	4-pin right angle			889D-R4ACDE-2
5-pin straight	5-pin straight			889D-F5ACDM-2
8-pin straight	8-pin straight			889D-F8ABDM-2 ²

¹ Replace the **2** after the dash with **1, 5, or 10** for additional lengths in meters.

² The 8-pin cordset is for Safety devices. To order with a red PVC jacket, replace the **A** in the catalog number with an **N**. For example, 889D-F8NB-2 or 889D-F8NBDM-2.

³ To order with black PVC jacket, replace the **A** in the catalog number with a **B**. For example, 889D-F4BC-2.

Terminal
Blocks

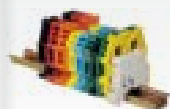

4-2...4-33

Wiring
Systems



4-34...4-35

Signal
Interface



4-36...4-39

Connection
Systems



4-40...4-49

Safety
Connection
Systems



4-50...4-53

Network
Media



4-54...4-61

AC Micro Cordsets & Patchcords 889R

- 3-, 4-, 5- and 6-pin connectors
- Straight or right angle female connector
- Standard 18 or 22 AWG braided cable
- Oil-resistant yellow PVC jacket



Product Selection

Cordsets

Female Connector Style	Cable			Cat. No. ¹	
	Wire Color	Wire Rating	Length [m (ft)]		
3-pin straight	1 Green (GND) 2 Red/Black Tr.	3 Red/White Tr.	Braided 22 AWG 250V, 4 A	2 (6.5)	889R-F3ECA-2
3-pin straight	1 Green (GND) 2 Red/Black Tr.	3 Red/White Tr.	18 AWG 250V 4 A		889R-F3AEA-2
4-pin straight	1 Red/Black Tr. 2 Red/White Tr.	3 Red 4 Green (GND)			889R-F4AEA-2
3-pin right angle	1 Green (GND) 2 Red/Black Tr.	3 Red/White Tr.	18 AWG 250V 4 A		889R-R3AEA-2
4-pin right angle	1 Red/Black Tr. 2 Red/White Tr.	3 Red 4 Green (GND)			889R-R4AEA-2
5-pin straight	1 Red/White Tr. 2 Red 3 Green	4 Red/Yellow Tr. 5 Red/Black Tr.	Braided 22 AWG 250V 4 A		889R-F5AEA-2
6-pin straight	1 Red/White Tr. 2 Red 3 Green	4 Red/Yellow Tr. 5 Red/Black Tr. 6 Red/Blue Tr.			889R-F6ECA-2

Patchcords

Female (Sensor End) Connector Style	Male (I/O End) Connector Style	Cable		Cat. No.
		Assembly Rating	Length [m (ft)]	
3-pin straight	3-pin straight	18 AWG, 250V, 4 A	2 (6.5)	889R-F3AERM-2

¹ Replace the **2** after the dash with **1, 5, or 10** for additional lengths in meters.



Connection Systems

CONNECTIVITY

Mini Cordsets 889N

- 3-, 4-, and 5-pin connectors
- Straight or right angle versions
- Heavy duty ST00W 16 AWG cable
- Oil-resistant yellow PVC jacket



Product Selection

Cordsets

Female Connector Style	Wire Rating	Length [m (ft)]	Cat. No. ¹	
			IEC	US
3-pin straight	16 AWG, 600V, 13 A	1.8 (6)	-	889N-F3AFC-6F
4-pin straight	16 AWG, 600V, 10 A	1.8 (6)	889N-F4AF-6F	889N-F4AFC-6F
5-pin straight	16 AWG, 600V, 8 A	1.8 (6)	889N-F5AF-6F	889N-F5AFC-6F
3-pin right angle	16 AWG, 600V, 13 A	1.8 (6)	-	889N-R3AFC-6F
4-pin right angle	16 AWG, 600V, 10 A	1.8 (6)	889N-R4AF-6F	889N-R4AFC-6F
5-pin right angle	16 AWG, 600V, 8 A	1.8 (6)	889N-R5AF-6F	889N-R5AFC-6F

¹ Replace the **6F** after the dash with **12F** or **20F** for additional lengths in feet.

Color Code

	3-pin	4-pin	5-pin
US	1 Green 2 Black 3 White	1 Black 2 White 3 Red 4 Green	1 White 2 Red 3 Green 4 Orange 5 Black
IEC	-	1 Black 2 Blue 3 Brown 4 White	1 Black 2 Blue 3 Orange 4 Brown 5 White



Need Help?
The Rockwell Automation Support Center is your 24/7 support for the answers you need now.
<https://rok.auto/support>

4-44

Terminal Blocks

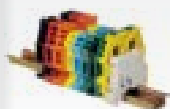

4-2...4-33

Wiring Systems



4-34...4-35

Signal Interface



4-36...4-39

Connection Systems



4-40...4-49

Safety Connection Systems



4-50...4-53

Network Media



4-54...4-61



Pico Cordsets & Patchcords 889P

- 3- or 4-pin connectors
- Straight or right angle female
- Standard 24 AWG cable
- Oil-resistant yellow PVC jacket

CONNECTIVITY

Product Selection

Cordsets

Female (Sensor End) Connector Style	Cable			Cat. No. ¹
	Wire Color	Wire Rating	Length [m (ft)]	
3-pin straight	1 Brown 3 Blue 4 Black	24 AWG 60V AC/75V DC 4 A	2 (6.5)	889P-F3AB-2
3-pin right angle			2 (6.5)	889P-R3AB-2
4-pin straight	1 Brown 2 White 3 Blue 4 Black		2 (6.5)	889P-F4AB-2

¹ Replace the **2** after the dash with **5** or **10** for additional lengths in meters.

Patchcords

Female (Sensor End) Connector Style	Male Connector (I/O End) Connector Style	Cable		Cat. No. ²
		Wire Rating	Length [m (ft)]	
3-pin straight	3-pin straight	24 AWG 60V AC/75V DC 4 A	1 (3.3)	889P-F3ABPM-1

² Replace the **1** after the dash with **2**, **5**, or **10** for additional lengths in meters.



Connection Systems

CONNECTIVITY

DC Micro & Pico Distribution Boxes 898D & 898P

- 4-pin DC micro or 3-pin pico connectors
- Top mount inputs
- 4- or 8-port parallel wired
- PNP wired LED versions
- Single input per port
- Prewired master cable
- Rugged grey Pocan® body



Product Selection

Style	No. of Connections	Illuminated	Operating Voltage/ Supply Current	Cable Length [m (ft)]	Cat. No.
DC Micro	4	PNP LED	10...30V DC 2 A max./port 10 A max. total	5 (16.4)	898D-P54PT-B5
				10 (32.8)	898D-P54PT-B10
	8			5 (16.4)	898D-P58PT-B5
				10 (32.8)	898D-P58PT-B10
Pico	4		10...30V DC 2 A max./port 6 A max. total	5 (16.4)	898P-P34PT-B5
	8				898P-P38PT-B5

Sales Offices and Distributors

Our network of sales offices and distributors offers exceptional knowledge and service to help you design, implement and support your automation investment.

<https://rok.auto/buy>



Terminal
Blocks

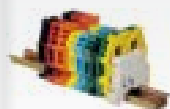

4-2...4-33

Wiring
Systems



4-34...4-35

Signal
Interface



4-36...4-39

Connection
Systems



4-40...4-49

Safety
Connection
Systems



4-50...4-53

Network
Media



4-54...4-61



Terminal Chambers & IDC Connectors 871A, 889D, 889P

- 4-pin micro or 3-pin pico connector
- Male and female versions
- Supports cable O.D. 4...8 mm

Product Selection

Screw Terminal

Description	Type	Connector Style	Jacket Cable Diameter [mm (in.)]	Wire Rating	Cat. No.
DC Micro	Female	4-pin straight	4.0...6.0 (0.16...0.24)	250V, 4 A	871A-TS4-D
			6.0...8.0 (0.24...0.32)		871A-TS4-D1
	Male		4.0...6.0 (0.16...0.24)		871A-TS4-DM
			6.0...8.0 (0.24...0.32)		871A-TS4-DM1

IDC Connector

Description	Type	Connector Style	Jacket Cable Diameter [mm (in.)]	Wire Rating	Cat. No.
DC Micro	Female	4-pin straight	4.0...5.1 (0.16...0.20)	32V, 4 A	889D-F4DC-H
	Male				889D-M4DC-H
Pico	Female	3-pin straight	4.0...5.1 (0.16...0.20)	32V, 3 A	889P-F3DC-H
	Male				889P-M3DC-H



Connection Systems

DC Micro & AC Micro Receptacles 888D & 888R

- Male and female versions
- 1/2 inch NPT threads
- 22 AWG conductors
- Rugged anodized aluminum body



Product Selection

DC Micro Style

Connector Style	Wire Color	Wire Rating	Length [m (ft)]	Panel Mount Thread Size	Cat. No.
4-pin female	1 Brown 2 White 3 Blue 4 Black	22 AWG 250V 4 A	0.3 (1)	1/2 in.-14 NPT	888D-F4AC1-0M3
4-pin male					888D-M4AC1-0M3
5-pin female	1 Brown 2 White 3 Blue 4 Black 5 Grey				888D-F5AC1-0M3
5-pin female					888D-M5AC1-0M3

AC Micro Style

Connector Style	Wire Color	Wire Rating	Length [m (ft)]	Panel Mount Thread Size	Cat. No.
3-pin female	1 Green (GND) 2 Red/Black Tr. 3 Red/White Tr.	22 AWG 250V 4 A	0.3 (1)	1/2 in.-14 NPT	888R-F3AC1-1F
3-pin male					888R-M3AC1-1F
4-pin female	1 Red/Black Tr. 2 Red/White Tr. 3 Red 4 Green (GND)	22 AWG 300V 3 A			888R-F4AC1-1F
4-pin male					888R-M4AC1-1F

Terminal Blocks

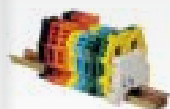

4-2...4-33

Wiring Systems



4-34...4-35

Signal Interface



4-36...4-39

Connection Systems



4-40...4-49

Safety Connection Systems



4-50...4-53

Network Media



4-54...4-61



Mini & Pico Receptacles 888N & 888P

- Male and female versions
- Heavy-duty 16 AWG conductors (mini)
- 24 AWG conductors (pico)
- Black epoxy-coated aluminum body (mini)
- Rugged nickel-plated brass body (pico)

Product Selection

Mini Style (US Color Code)

Connector Style	Wire Color	Wire Rating	Length [m (ft)]	Panel Mount Thread Size	Cat. No.
3-pin female	1 Green 2 Black 3 White	16 AWG 600V 13 A	0.3 (1)	1/2 in.-14 NPT	888N-F3AF1-1F
3-pin male					888N-M3AF1-1F
4-pin female	1 Black 2 White 3 Red 4 Green	16 AWG 600V 10 A			888N-F4AF1-1F
4-pin male					888N-M4AF1-1F
5-pin female	1 White 2 Red 3 Green 4 Orange 5 Black	16 AWG 600V 8 A			888N-F5AF1-1F
5-pin male					888N-M5AF1-1F

Pico Style

Connector Style	Wire Color	Wire Rating	Length [m (ft)]	Panel Mount Thread Size	Cat. No.
3-pin female	1 Brown 3 Blue 4 Black	24 AWG 60V AC/75V DC 4 A	0.3 (1)	M8 x 0.5	888P-F3AB4-0M3
3-pin male					888P-M3AB4-0M3
4-pin female	1 Brown 2 White 3 Blue 4 Black				888P-F4AB4-0M3
4-pin male					888P-M4AB4-0M3



Safety Connection Systems

Safety Connectivity

Allen-Bradley safety connection systems offer a complete wiring solution dedicated to machine safety.

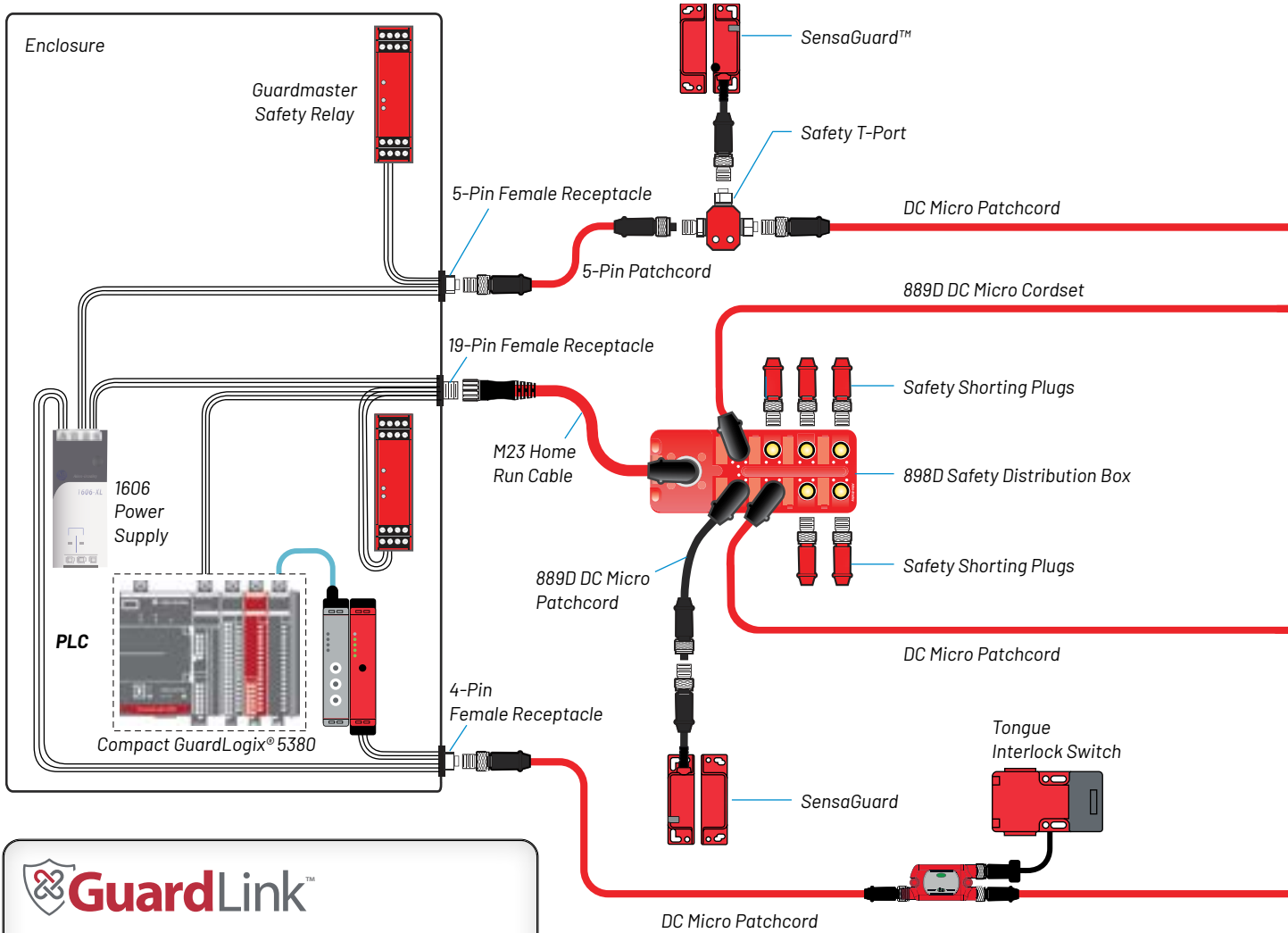

GuardLink™

GuardLink is a safety-based communications protocol that links safety to The Connected Enterprise. Allen-Bradley® Guardmaster® smart safety devices featuring GuardLink technology deliver information, advanced functionality and flexibility, while enhancing safety and increasing efficiency machine- and plant-wide.

<https://rok.auto/guardlink>

Application

Safety Connectivity is suited for compact machines with a limited number of safety components using safety relays for monitoring.

* Product selection for red patchcords can be found on page 4-42.

Terminal Blocks

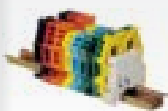

4-2...4-33

Wiring Systems

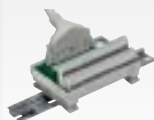

4-34...4-35

Signal Interface



4-36...4-39

Connection Systems



4-40...4-49

Safety Connection Systems



4-50...4-53

Network Media



4-54...4-61

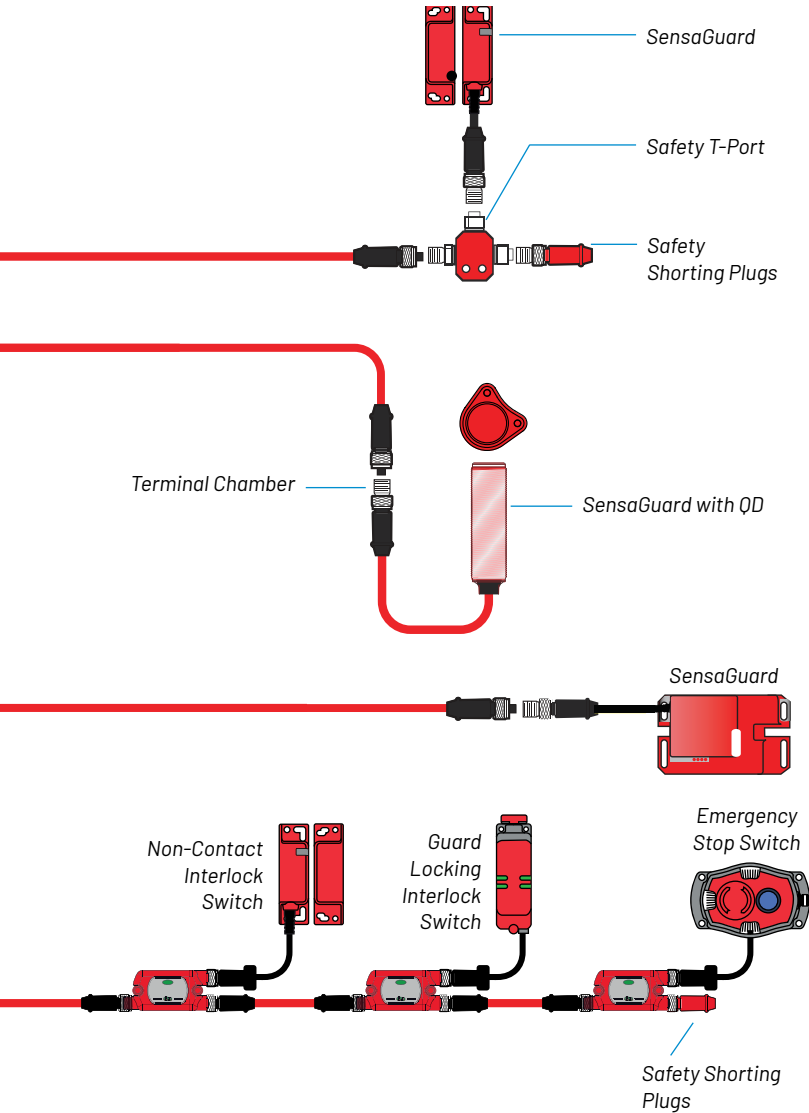

Allen-Bradley Guardmaster safety connection systems are complete quick-disconnect wiring solutions dedicated to machine safety.

Components

- Safety-wired GuardLink Enabled Taps
- Safety-wired distribution boxes
- Safety-wired shorting plugs
- Patchcords
- Receptacles

Connector Options

- DC Micro (M12)
- M23

Flexible and reliable connections for safety

- Interlock switches
- Safety limit switches
- Cable pull switches
- Guard locking
- SensaGuard
- E-Stops
- Safety relays
- Safety mats switches

Not Suitable For

- Pressure-sensitive safety edges

Notes

- Designed to simplify the installation of safety devices
- Reduced installation costs, simplified expansion and troubleshooting, increased modularity
- Single- or dual-channel options with or without enunciation
- Enunciation systems allow direct feedback on individual systems in the system and provide an auxiliary contact as input for tower lights, audible alarms, PLC input cards, etc.
- Shorting plugs must be installed in all unused distribution box ports for the system to operate



Safety Connection Systems

Safety Distribution Boxes 898D & 898R

- Prewired for compatibility with safety dual-channel and three-channel switches
- For use in Cat 2, 3, or 4 systems per EN 954-1 and up to SIL3 per EN 13849-1
- Enunciation models identify open contacts via LEDs on box and discrete wire in home-run connection



Product Selection – Safety Wired Distribution Box

Dual-Channel

Safety Switch Configuration	Enunciation	Connection Type	No. of Ports	Home Run Connection	Cat. No.
2 N.C.	No	4-pin DC micro	4	DC micro pigtail, 200 mm (7.87 in.)	898D-44LT-DM4
			8		898D-48LT-DM4
1 N.C. & 1 N.O. for Enunciation	Yes	4-pin DC micro	8	Cable, 5 m (16.4 ft)	898D-P48JT-A5
				Cable, 10 m (32.8 ft)	898D-P48JT-A10
2 N.C. & 1 N.O. for Enunciation	Yes	6-pin AC micro	8	Cable, 5 m (16.4 ft)	898R-P68MT-A5
				Cable, 10 m (32.8 ft)	898R-P68MT-A10
2 OSSD ¹	Yes	8-pin DC micro	4	M23, 19-pin	898D-P84RT-M19
			8		898D-P88RT-M19

¹ SensaGuard compatible.



Product Selection Tools

Available online or for download, our tools help you access info while in the office or on the go.

<https://rok.auto/selection>

* Product selection for red patchcords can be found on page 4-42.

Terminal Blocks

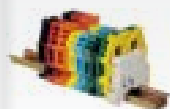

4-2...4-33

Wiring Systems



4-34...4-35

Signal Interface



4-36...4-39

Connection Systems



4-40...4-49

Safety Connection Systems



4-50...4-53

Network Media



4-54...4-61



Safety Wired T-Port & Shorting Plug 898D & 898R

Safety Wired T-Port

- T-Port/splitter designed for use with dual-channel safety devices with four-pin DC micro connector
- For use in Cat 2 or 3 systems per EN 954-1
- SensaGuard™ units may be wired in series maintaining a Cat 4/SIL3 rating

Safety Wired Shorting Plug

- Shorting plug designed for use with safety-wired distribution boxes
- Ratcheting coupling nut on four-pin models for vibration resistance

Product Selection – Safety Wired T-Port

DC Micro Style (Dual-Channel, No Enunciation)

Configuration	Female QD (2 Ports)	Male QD (1 Port)	Cat. No.
2 N.C.	4-pin DC micro	4-pin DC micro	898D-43LY-D4
1 N.O. & 1 N.C.			898D-43KY-D4
For use with SensaGuard switches only		8-pin DC micro	898D-438Y-D8

Product Selection – Safety Wired Shorting Plug

DC & AC Micro Style

Safety Switch Configuration	Male QD	Coupling Nut Material	Cat. No.
2 N.C.	4-pin DC micro	Epoxy-coated zinc	898D-41LU-DM
1 N.O. & 1 N.C.			898D-41KU-DM
2 N.C. & 1 N.O.	6-pin DC micro	Nickel-plated brass	898R-61MU-RM
For use with SensaGuard compatible T-Ports only	4-pin DC micro		898D-418U-DM
2 OSSD	8-pin DC micro		898D-81RU-DM
2 OSSD with 24V DC connected to Aux. input			898D-81RU-DM2

* Product selection for red patchcords can be found on page 4-42.



Network Media

Industrial Ethernet Connectivity

We offer a complete portfolio of industrial-grade Ethernet physical media specifically designed for use in harsh environments.

Application

Ethernet Network Connectivity is ideal for highly distributed machines that require extensive diagnostics at the PLC.

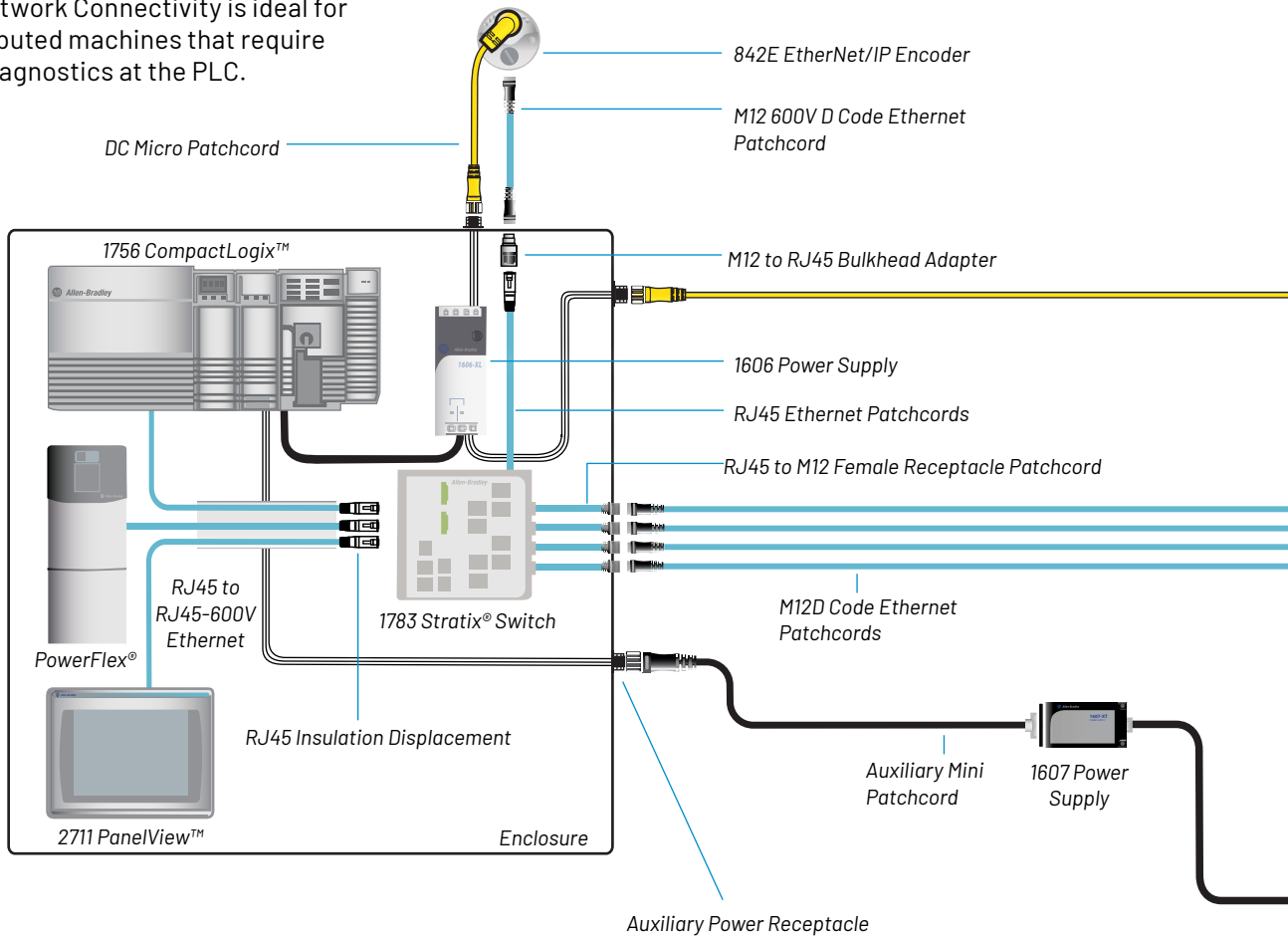

Sales Offices and Distributors

Our network of sales offices and distributors offers exceptional knowledge and service to help you design, implement and support your automation investment.

<https://rok.auto/buy>

Terminal Blocks

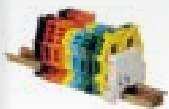

4-2...4-33

Wiring Systems

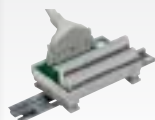

4-34...4-35

Signal Interface



4-36...4-39

Connection Systems



4-40...4-49

Safety Connection Systems



4-50...4-53

Network Media



4-54...4-61

Allen-Bradley® Ethernet media components combine specially-designed cable with rugged connector construction to preserve network integrity and performance.

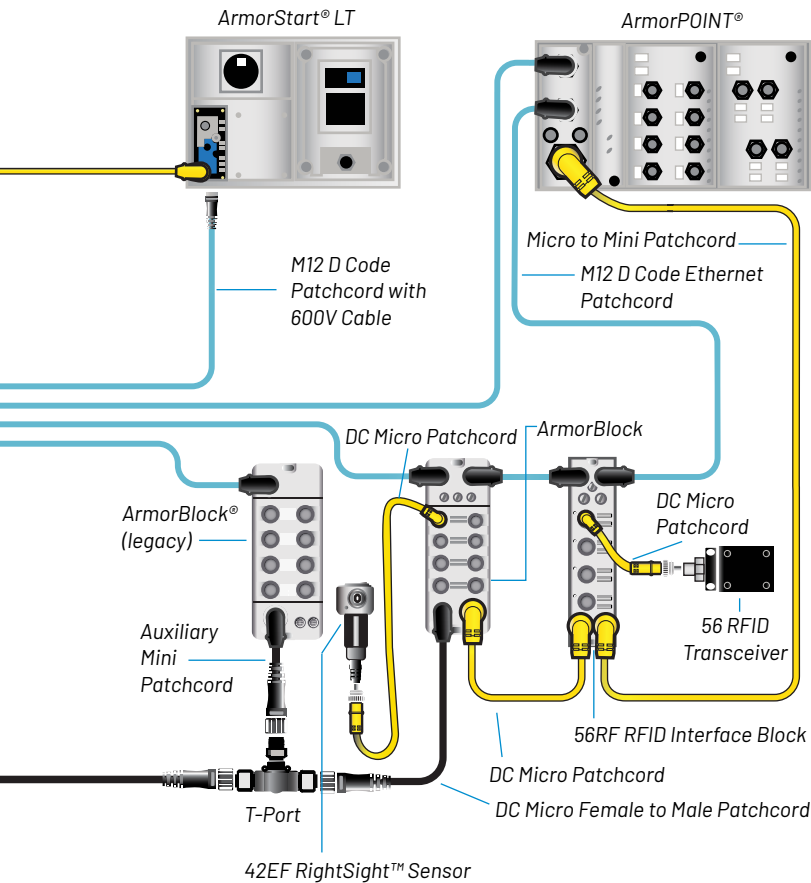

Components

- Cordsets and patchcords
- Receptacles/outlets
- Bulkhead adapters
- Raw cable spools
- Field-attachable connectors

Connector Options

- RJ45 (IP20)
- M12 D-Coded (IP67)

Two- or four-pair shielded and unshielded cable options in multiple cable jackets:

- Two-pair for 10/100 BaseT and On-Machine applications
- Four-pair for backbone and uplink ports or any areas requiring data rates greater than 100 BaseT Interlock switches
- PVC Cable – General purpose applications
- PUR Cable – High flex, Halogen-free
- TPE Cable – High flex applications
- Plenum Cable – Air handling applications
- 600V PVC – Use in cable trays with up to 600V rated cables

Notes

- Allen-Bradley Ethernet media is designed to ODVA EtherNet/IP™ standards for enhanced performance in industrial applications
- The 600V rated cable has a 600V AWM rating as well as PLTC (Power Limited Tray Cable) – NEC Type PLTC Listed, which is approved for cable tray use in Class 1, Division 2, hazardous areas and nonhazardous areas, cable trays, raceways, conduit and supported by messenger wires
- Transition from inside the cabinet to on-machine can be accomplished with an RJ45-to-M12 bulkhead adapter or an RJ45-to-M12 female panel mount patchcord. Both solutions provide a sealed solution mounted on to the cabinet and enables as easy transition from IP20 to IP67
- High flex cables rated to 10 million flexing cables



Network Media

Ethernet Media Cable Spools 1585

- Four- and eight-conductor styles
- 24 AWG conductors, Cat 5e
- Twisted pairs maintain signal balance through cable to provide high noise immunity without need for shield
- Designed to ODVA EtherNet/IP™ specifications and ISO IEC 24702, IEC 61918
- Suitable in noise environments M3 I3 C3 E3
- Robotic cables are flex rated, rated to 10 million cycles



Product Selection

Cable Spools

Cable Type	No. of Conductors	Nominal Outer Diameter	Jacket Color	Color Code	Cable Rating	Cat. No. ¹
Unshielded riser PVC	8 (four pair)	5.84 mm (0.23 in.)	Teal	White/Orange, Orange, White/Green, Blue, White/Blue, Green, White/Brown, Brown	UL CMR; cUL CMG; Standard TIA 568-B	1585-C8PB-S100
Unshielded robotic TPE	4 (two pair)	5.6 mm (0.22 in.)	Teal	White/Orange, White/Green, Orange, Green	Weld splatter, sunlight, and oil resistant; UL CM, CMX; cUL CM; Standard TIA 568-B, high flex rated	1585-C4TB-S100
	8 (four pair)	5.84 mm (0.23 in.)	Teal	White/Orange, Orange, White/Green, Blue, White/Blue, Green, White/Brown, Brown	Weld splatter, sunlight and oil resistant; UL CM, CMX; cUL CM; Standard TIA 568-B, high flex rated	1585-C8TB-S100
Foil and braided shield robotic PUR	8 (four pair)	6.2 ± 12 mm (0.244 in.)	Teal	-	C(ETL)US TYPE CMX; TIA 568-B, Flex rated, Halogen-Free	1585-C8UB-S100
Foil and braided shield robotic PUR	4 (two pair)	-	Teal	-	C(ETL)US TYPE CMX; TIA 568-B, Flex rated, Halogen-Free	1585-C4UB-S100
Foil shield 600V PVC	8 (four pair)	8.13 ± 0.38 mm (0.32 in.)	Teal	-	(UL) CMX, CMR; c(UL) CMG; (UL) PLTC or AWM 257080 °C 600V; TIA-568-B	1585-C8HB-S100

¹ Replace **S100** with **S300** (300 m) or **S600** (600 m) for additional cable lengths.

Terminal Blocks

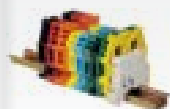

4-2...4-33

Wiring Systems

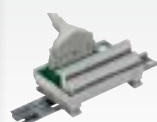

4-34...4-35

Signal Interface



4-36...4-39

Connection Systems



4-40...4-49

Safety Connection Systems



4-50...4-53

Network Media



4-54...4-61



Ethernet M12 D Code Cordsets & Patchcords 1585D

- Industrial-grade overmolded IP67 cable
- Flex-rated to 10 million cycles
- Single-ended cordsets can be custom terminated with one of several field-attachable connectors
- Designed to ODVA EtherNet/IP specifications and ISO IEC 24702, IEC 61918
 - Twisted pairs provide high noise immunity
 - Suitable for noise environments M3 I3 C3 E3
 - Cat 5e

Product Selection

M12 D Code Cordsets

Cable Style	First End Connector	Second End Connector	Cat. No. ¹
TPE, high flex, unshielded	Male M12 D-code, straight	Flying leads	1585D-M4TB-2
PUR, foil and braided shield, high flex, halogen free			1585D-M4UB-2
PVC, 600V rated, foil shield			1585D-M4HB-2

M12 D Code Patchcords

Cable Style	First End Connector	Second End Connector	Cat. No. ¹
TPE, high flex, unshielded	Male M12 D-code, straight	Male M12 D-code, straight	1585D-M4TBDM-2
	Male M12 D-code, right angle	Male M12 D-code, right angle	1585D-E4TBDE-2
	Male M12 D-code, straight	Male M12 D-code, right angle	1585D-M4TBDE-2
	Male M12 D-code, straight	Female M12 D-code, straight	1585D-M4TBDF-2
PUR, foil and braided shield, high flex, halogen free	Male M12 D-code, straight	Male M12 D-code, straight	1585D-M4UBDM-2
	Male M12 D-code, right angle	Male M12 D-code, right angle	1585D-E4UBDE-2
	Male M12 D-code, straight	Male M12 D-code, right angle	1585D-M4UBDE-2
	Male M12 D-code, straight	Female M12 D-code, straight	1585D-M4UBDF-2
PVC, 600V rated, foil shield	Male M12 D-code, straight	Male M12 D-code, straight	1585D-M4HBDM-2
	Male M12 D-code, right angle	Male M12 D-code, right angle	1585D-E4HBDE-2
	Male M12 D-code, straight	Male M12 D-code, right angle	1585D-M4HBDE-2
	Male M12 D-code, straight	Female M12 D-code, straight	1585D-M4HBDF-2
TPE, high flex, unshielded	Male M12 D-code, straight	RJ45, straight	1585D-M4TBJM-2
PUR, foil and braided shield, high flex, halogen free			1585D-M4UBJM-2
PVC, 600V rated, foil shield			1585D-M4HBJM-2

¹ Replace 2 (2 m) with 1 (1 m), 5 (5 m), or 10 (10 m) for additional standard cable lengths. Other standard and build-to-order lengths are available. Contact your local Rockwell Automation sales office or Allen-Bradley distributor for details.



Network Media

CONNECTIVITY

Ethernet RJ45 Cordsets & Patchcords 1585J

- PVC riser and flex-rated TPE and PUR cables for various applications
- Rugged strain relief and hitch mechanism to maintain network integrity
- Suitable environments M3 I3 C3 E3
- Unshielded, #24 AWG
- Flex rated to 10 million cycles
- Cat 5e



Product Selection

RJ45 Cordsets

No. of Conductors	Jacket Material	Shielding	Cat. No. ¹
4	Teal high-flex TPE	Unshielded twisted pair	1585J-M4TB-2
8	Teal high-flex TPE		1585J-M8TB-2
8	Teal riser PVC		1585J-M8PB-2
8	Teal riser PVC	Foil and braided shield	1585J-M8CB-2
4	Teal high-flex PUR		1585J-M4UB-2
8	Teal high-flex PUR		1585J-M8UB-2
8	Teal 600V PVC	Foil shield	1585J-M8HB-2

RJ45 Patchcords

No. of Conductors	Jacket Material	Cable Type	Cable Rating	Cat. No. ¹
4	Teal high-flex, TPE	Unshielded twisted pair	Weld splatter, sun light and oil resistant; UL CMG, CMX; cUL CMG; Standard TIA 568-B, flex rated	1585J-M4TBJM-2
8	Teal high-flex, TPE			1585J-M8TBJM-2
8	Teal riser, PVC		UL CMR; cUL CMG; Standard TIA 568-B	1585J-M8PBJM-2
4	Teal high-flex, PUR	Braid over foil shield	C(ETL)US TYPE CMX; TIA 568-B, flex-rated, halogen-free	1585J-M4UBJM-2
8	Teal riser, PVC		UL CMR; CUR CMG, TIA B	1585J-M8CBJM-2
8	Teal high-flex, PUR		C(ETL)US TYPE CMX; TIA 568-B, flex-rated, halogen-free	1585J-M8UBJM-2
	Teal 600V, PVC	Foil shield	(UL) CMX, CMR; c(UL) CMG; (UL) PLTC or AWM 2570 80 °C 600V; TIA-568-B	1585J-M8HBJM-2

¹ Replace **2** (2 m) with **1** (1 m), **5** (5 m), or **10** (10 m) for additional standard cable lengths. Other standard and build-to-order lengths are available. Contact your local Rockwell Automation sales office or Allen-Bradley distributor for details.

Terminal Blocks

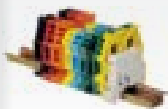

4-2...4-33

Wiring Systems

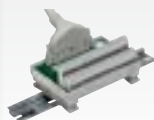

4-34...4-35

Signal Interface



4-36...4-39

Connection Systems



4-40...4-49

Safety Connection Systems



4-50...4-53

Network Media



4-54...4-61



Ethernet Accessories 1585D, 1585A, & 1585J

- Field-installable accessories for easy cabling modification
- For use with raw cable or single-ended cordsets
- M12 and RJ45 styles
- M12 to RJ45 adapter for bulkhead installation

Product Selection

M12 Insulation Displacement Connector

No. of Pins	Connector Material	Cable Diameter [mm (in.)]	Wire Size	Assembly Rating	Connector Style	Cat. No.
4	Polyamide small body unshielded	4.0...5.1 (0.16...0.20)	#26...22 AWG	32V, 4 A	Straight male	1585D-M4DC-H
	Zinc die-cast large body shielded	5.5...7.2 (0.22...0.28)	#24...22 AWG		Straight female	1585D-F4DC-SH
					Straight male	1585D-M4DC-SH

Field Attachable RJ45 Connectors

Description	Material	Insulation Material	Contact Material	Channel Bandwidth	Cat. No.
RJ45 insulation displacement connector (IDC)	Diecast zinc	Plastic	Gold-plated copper alloy	Cat 6	1585J-M8CC-H

4-pin, M12 Receptacle & M12 to RJ45 Adapter

Description	Mounting	Assembly Rating	Cat. No.
Female M12 receptacle to RJ45 female adapter right angle	PG 9 panel mount threads	32V, 4 A	1585A-DD4JD



Network Media

CONNECTIVITY

Gigabit Ethernet Connectivity 1585D/1585J

- Ethernet speeds of 1 Gigabit per second
- 360 degree shield for optimal signal performance without system noise interference
- Cat 6, UL Listed. Conforms to ISO IEC 11801, ANSI/TIA-1005, TIA-568-C.2.
- Flex-rated TPE cables for various applications.
- M12 feature X-code key alignment and are IP67 and M3 I3 C3 E3 rated
- RJ45 features ideal 1p20 industrial applications and M1 I1 C2 E2

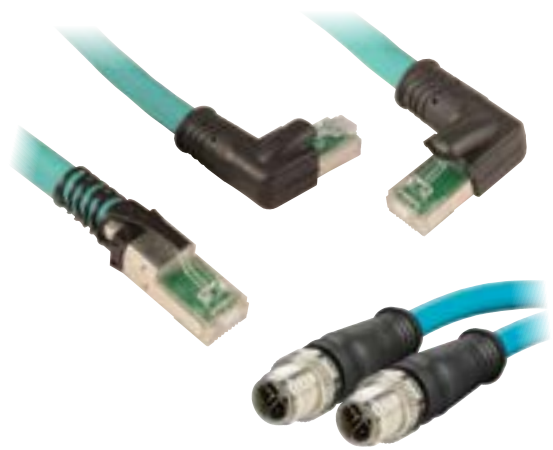

Innovative Connectivity for Demanding High-speed Data Transfer in Industrial Applications

Our Ethernet media connects with Stratix™ Ethernet switches, programmable controllers, PanelView™ graphic terminals and drives.

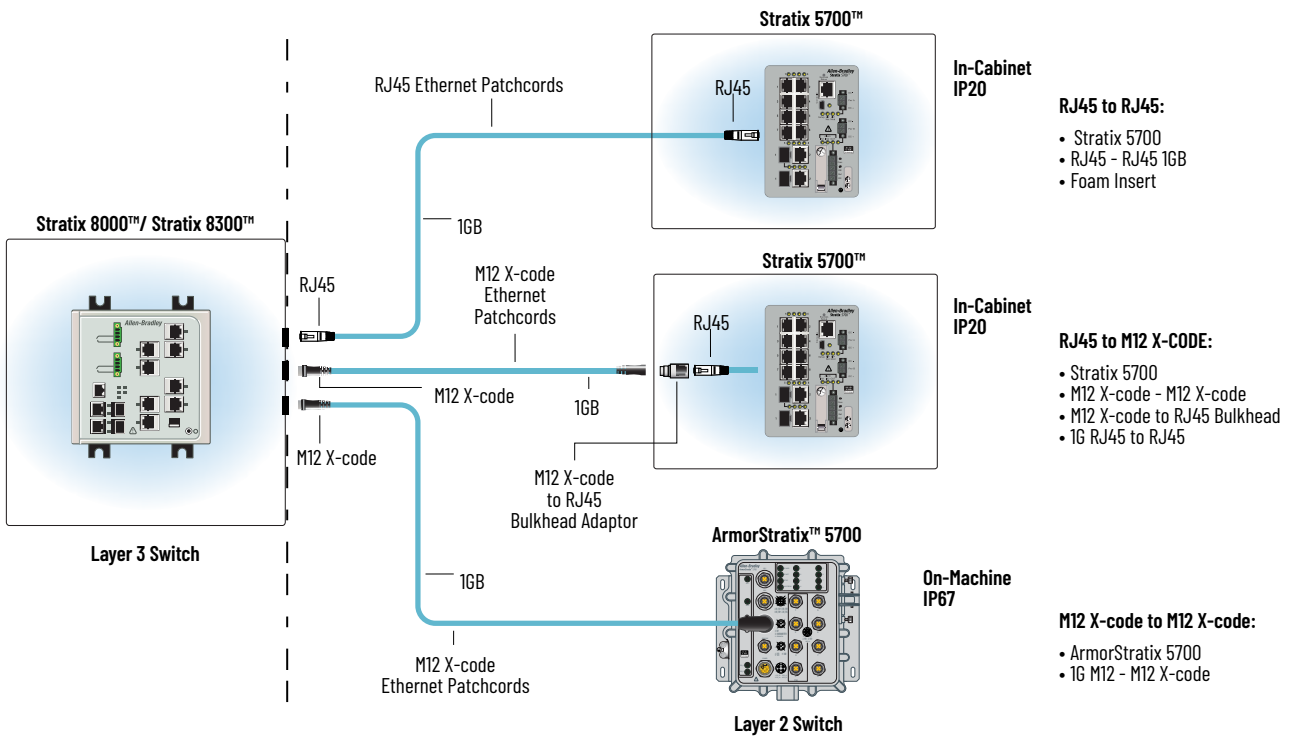

Terminal Blocks

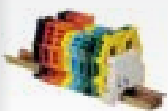

4-2...4-33

Wiring Systems

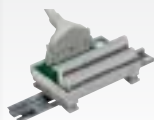

4-34...4-35

Signal Interface



4-36...4-39

Connection Systems



4-40...4-49

Safety Connection Systems



4-50...4-53

Network Media



4-54...4-61

Product Selection

RJ45 Gigabit Cordset

Shielding	Connector Style	Cable Type	Cable Length	Cat. No. ¹
Foil and braided shield	Straight male	8-conductor, teal high-flex TPE, 600V	2 m (6.56 ft)	1585J-M8TG-2
Foil and braided shield	Right angle male	8-conductor, teal high-flex TPE, 600V	2 m (6.56 ft)	1585J-E8TG-2

RJ45 Gigabit Patchcords

Shielding	Connector Style	Cable Type	Cable Length	Cat. No. ¹
Foil and braided shield	RJ45 straight male	8-conductor (4 pair), teal high-flex TPE, 600V	2 m (6.56 ft)	1585J-M8TGJM-2
Foil and braided shield	RJ45 straight male to right angle male	8-conductor (4 pair), teal high-flex TPE, 600V	2 m (6.56 ft)	1585J-M8TGJE-2
Foil and braided shield	RJ45 right angle male to right angle male	8-conductor (4 pair), teal high-flex TPE, 600V	2 m (6.56 ft)	1585J-E8TGJE-2

¹ Replace **2** (6.56 ft) with **5** (16.4 ft) or **10** m (32.8 ft) for additional standard cable lengths.

M12 X-code to M12 X-code Patchcords

Shielding	Connector Style	Cable Type	Cable Length	Cat. No. ¹
Foil and braided shield	Straight male	Shielded teal PUR, 4 twisted pairs, 26 AWG, Industrial Cat 6, UL Listed, sun light and oil resistant	1 m (3.28 ft)	1585D-M8UGDM-1

M12 X-code to RJ45 Patchcord

Shielding	Connector Style	Cable Type	Cable Length	Cat. No. ²
Foil and braided shield	Straight male	Shielded teal PUR, 4 twisted pairs, 26 AWG, Industrial Cat 6, UL Listed, sun light and oil resistant	1 m (3.28 ft)	1585D-M8UGJM-1

² Replace **1** with **2** m (6.56 ft), **3** m (9.84 ft), **4** m (13.1 ft), **5** m (16.4 ft), **10** m (32.8 ft), **15** m (49.5 ft), **20** m (65.6 ft), **30** m (98.42 ft), or **40** m (131.23 ft) for additional standard cable lengths.

Accessories

Description	Cat. No.
Female M12 X-code receptacle to RJ45 female adaptor right angle	1585A-DD8JD



Additional Connectivity Products



DeviceNet Media

Used as the backbone for your DeviceNet network, our media includes multiple trunk and drop cable solutions to best suit your topology.

- Choose from traditional round media or time-saving KwikLink™ flat media
- Options for IP20 and IP67 applications
- Available in bulk spools or pre-molded cordsets or patchcords
- DeviceNet media tools help simplify your network installation and diagnostics

NEMA and Process Terminal Blocks 1492, 1492JP

The 1492 family of NEMA terminal blocks offer easy wiring with standard size screwdrivers, easy visual verification of proper wire position and easy marking.

1492-JP process terminal blocks are designed specifically for process marshalling applications to save 45% panel space and improve the performance of signal routing and distribution.

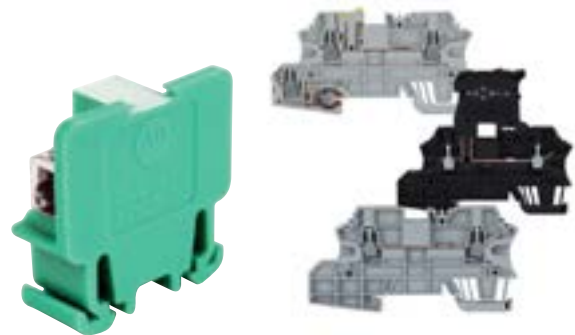

Terminal
Blocks

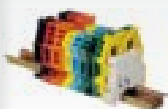

4-2...4-33

Wiring
Systems



4-34...4-35

Signal
Interface



4-36...4-39

Connection
Systems



4-40...4-49

Safety
Connection
Systems



4-50...4-53

Network
Media



4-54...4-61

GuardLink Technology 5-2

Presence Sensing Safety Devices

Safety Light Curtains
GuardShield 450LB Point of Operation
Control Type 4 5-4
GuardShield 450LE Point of Operation
Control Type 4 5-6
GuardShield 440L Point of Operation
Control Type 4 5-8
Micro 400 Point of Operation Control Type 4 5-10
GuardShield Perimeter Access
Control Type 4 & Safe 4 /Micro 400 5-12
SafeZone Safety Laser Scanners 5-14
SC300 Safety Sensor 5-16
Safety Mat System 5-18

Interlock Switches

SensaGuard Non-Contact Switches 5-20
Magnetically Coded Non-Contact Switches 5-22
Tongue Interlock Switches 5-24
Electromagnetic Switches 5-28
440G-LZ Guard Locking Switches 5-30
440G-MZ Guard Locking Switches 5-32
TLS-Z GD2 Guard Locking Switches 5-34
TLS-GD2 Guard Locking Switches 5-36
Trapped Key Switches 5-38

Access Control

Guardmaster Multifunctional Access Box 5-40

Safety Relays

Software-Configurable Relay 5-42
Guardmaster Safety Relays (GSR Family) 5-44
Single and Specialty Function Safety Relays
(MSR Family) 5-46

Emergency Stop Devices

Lifeline Cable Pull Switches 5-48

Safety Limit Switches

22 mm Metal and Plastic, 30 mm Metal and 15 mm
Plastic 5-50

Additional Safety Products 5-52

GuardLink Technology

GuardLink® Technology

GuardLink is a safety-based communications protocol that links safety to The Connected Enterprise. Allen-Bradley® Guardmaster® smart safety devices featuring GuardLink technology deliver information, advanced functionality and flexibility, while enhancing safety and increasing efficiency machine- and plant-wide. GuardLink enabled devices offer advanced features and diagnostics that can only be accessed through a GuardLink connection tap.



GuardLink provides access to diagnostic data when the safety function occurs

- No configuration is required, with wiring achieved through the use of standard cables with M12 connectors
- A maximum of 32 safety input devices can be connected in series
- GuardLink enabled taps allow standard safety input devices with either electromechanical or solid state safety outputs to be connected to a GuardLink system
- Passive taps allow safety input devices with built-in GuardLink technology to be connected to a GuardLink system
- Remote lock/unlock and fault reset of safety input devices can be achieved
- Certified for applications up to and including PLe Cat 4 (ISO 13849-1) and SIL CL3 (IEC 62061)

Why choose GuardLink?

Series connection of safety input devices is common practice in safety control systems. However when the system trips, fault finding is difficult due to the lack of diagnostic information. Providing diagnostics historically meant connecting auxiliary contacts from each safety input device to the PLC increasing costs due to the need for additional input cards, and increased installation time to hard wire each auxiliary contact to the allocated input. GuardLink provides both safety information and diagnostics through the same cable, with the diagnostics available via EtherNet/IP, reducing the amount of wiring required for the safety system, and the cost and time to install the solution.

GuardLink Example System

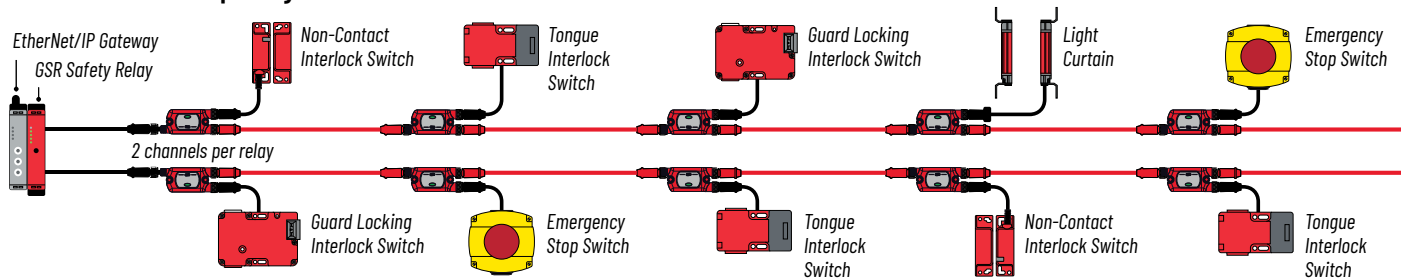

Presence Sensing Devices



5-4...5-19

Interlock Switches



5-20...5-39

Access Control



5-40...5-41

Safety Relays



5-42...5-47

Emergency Stop Devices



5-48...5-49

Safety Limit Switches



5-50...5-51

GuardLink Enabled Connection Taps

- Provides device location and status to DG Relay
- Two bright indicators for device and link communication status
- Compact 40 mm housing fits on standard aluminum profiles
- TÜV Approved PLe, SIL 3, Cat 4 Rated
- IP65/IP67/IP69k environmental rating
- Power-To-Release and Power-To-Lock taps available

DG Guardmaster Safety Relays

- Dual channel relay monitors up to two circuits – one or two GuardLink circuits, one or two safety input devices, or one of each
- Local controls to configure the safety function
- Configurable multipurpose terminals
- Relay outputs to switch higher loads
- Connectivity to network interface via optical link
- Support of Single Wire Safety (SWS) to cascade multiple safety relays
- Add-on profile for Studio 5000® Logix Designer software provides access to relay and GuardLink device data

Product Selection

	Description	Catalog Number
Safety Relay, Ethernet Gateway and cable to the first GuardLink enabled tap	Ethernet Gateway	440R-ENETR
	Guardmaster Safety Relay Dual GuardLink Master	440R-DG2R2T
	Replace * in order number with 2, 5, 10, 15, 20 or 30 for required cable length in Meters	889D-F4NE-*
GuardLink enabled taps and cables to connect between the taps	5-pin GuardLink Enabled Tap for use with 5-pin Electronic Safety Input devices	400S-SF5D
	8-pin GuardLink Enabled Tap for use with 8-pin Electronic Safety Input devices	440S-SF8D
	5-pin GuardLink Enabled Tap for use with 5-pin Electromechanical Safety devices	440S-MF5D
	8-pin GuardLink Enabled Tap for use with 8-pin Electromechanical Safety devices (available September 2018)	440S-MF8D
	Replace ** in order number with OM3, OM6, 1, 2, 5, 10, 15, 20 or 30 for cable length in Meters (OM3=300mm, OM6=600mm)	889D-F4NEDM-**
Connection cables from the GuardLink enabled taps to the input devices	Replace *** in order number with OM3, OM6, 1, 2, 5 or 10 for cable length in Meters (OM3=300mm, OM6=600mm)	889D-F5NCDM-***
	Replace *** in order number with OM3, OM6, 1, 2, 5 or 10 for cable length in Meters (OM3=300mm, OM6=600mm)	889D-F8NBDM-***
Accessories	Terminator for last GuardLink Enabled Tap	898D-418U-DM2
	GuardLink Enabled Tap Mounting Bracket - QTY 1	440S-GLTAPBRK1
	GuardLink Enabled Tap Mounting Bracket - QTY 5	440S-GLTAPBRK5

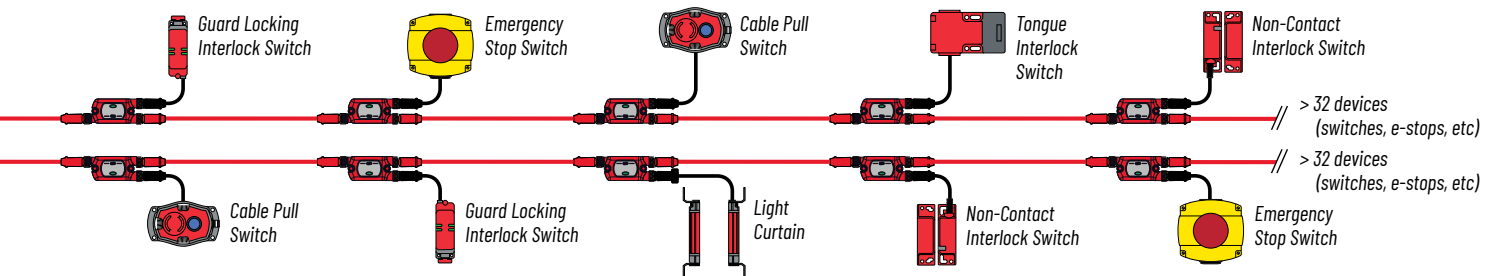

For more information on our complete family of presence sensing safety device products, please visit:
<https://rok.auto/safety-products>



Presence Sensing Safety Devices

SAFETY

GuardShield™ POC Type 4 Safety Light Curtain 450L-B

- Point of Operation Control (POC) for finger or hand protection
- Innovative plug-in modules (purchased separately) for application flexibility and reduced inventory costs
- Protection heights 150...1950 mm (5.9...76.7 in.) in increments of 150 mm (0.5 ft)
- Compact design 30 mm x 30 mm (1.18 in. x 1.18 in.)
- TÜV certified Ple, Type 4 IEC 61496-1/-2, SILCL3 per EN ISO 13849-1, IEC 62061



World's first CIP Safety Over Ethernet/IP™ Safety Light Curtain

The GuardShield 450L-B Safety Light Curtain system features a patented technology which allows each transceiver to be used as a transmitter or receiver via an innovative plug-in module. The functionality of a pair of 450L-B safety light curtains is determined by inserting a plug-in module into the bottom of each transceiver. This advanced technology greatly reduces stock and provides a flexible, cost-effective safety solution. Plus, connection over EtherNet/IP makes the light curtain a smart safety device that enhances safety and delivers diagnostics while providing connectivity through The Connected Enterprise®.

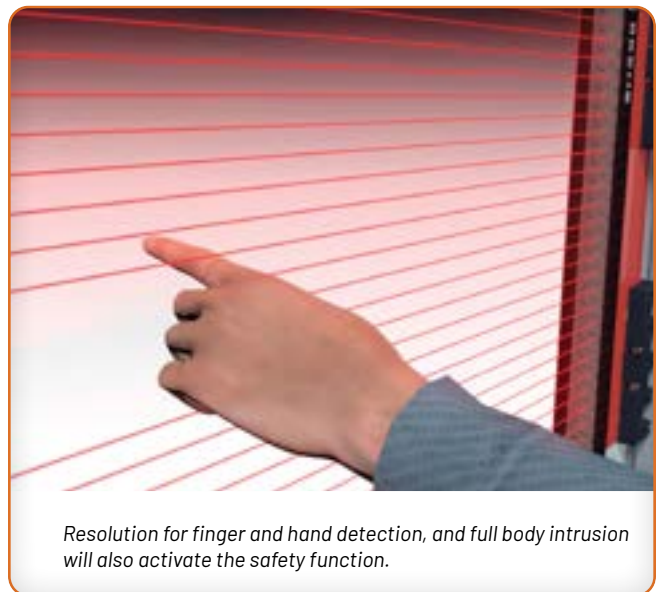
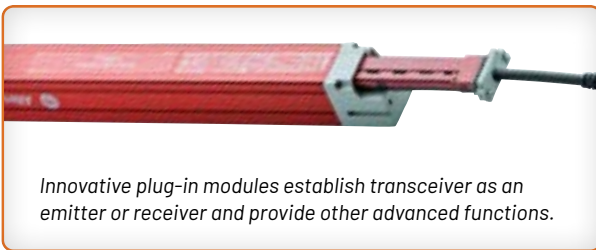

Presence Sensing Devices



5-4...5-19

Interlock Switches



5-20...5-39

Access Control



5-40...5-41

Safety Relays



5-42...5-47

Emergency Stop Devices



5-48...5-49

Safety Limit Switches



5-50...5-51

Product Selection

Light Curtain System: Order two identical transceivers/catalog numbers

Description	Catalog Number ¹
Transceiver with finger resolution. 14 mm (0.55 in.) resolution. Top and bottom mounting kit included ²	450L-B4FNxxxxYD
Transceiver with hand resolution. 30 mm (1.18 in.) resolution. Top and bottom mounting kit included ²	450L-B4HNxxxxYD

¹ **xxxx** = 0150 ... 1950 mm (0.5 ... 6.4 ft) in increments of 150 mm (0.5 ft).
For example: "450L-B4FN**0900**YD" indicates an order for 900 mm finger detection light curtain system.

² Optional side mounting bracket kit is available below.

Plug-in Modules: Order one transmitter and one receiver plug-in with the desired functionality for one system – **or** – Order two universal plug-ins for one system. Each universal plug-in can be used as a transmitter or a receiver.

Description	Catalog Number
Transmitter plug-in, M12 5-pin	450L-APT-PW-5
Receiver plug-in, M12 5-pin, On/Off	450L-APR-ON-5
Transmitter plug-in, M12 8-pin ³	450L-APT-PW-8
Receiver plug-in, M12 8-pin, reset mode, EDM, scanning range	450L-APR-ED-8
Universal plug-in, M12 8-pin, reset mode, EDM, scanning range ⁴	450L-APU-UN-8
Receiver plug-in, M12 8-pin CIP Safety over EtherNet/IP ⁵	450L-APR-EN-8

³ The 8-pin transmitter plug-in option allows two 8-pin cordsets to be used in one system.

⁴ Order two universal plug-ins for one system. Each universal plug-in can be used as a transmitter or a receiver.

⁵ 450L-ENETR Network Interface Module is also required.

Specifications

Standards	Type 4 (IEC 61496), PLe Cat 4 (ISO 13849-1), SIL CL3 (IEC 62061)
Certifications	UL Listed, TUV Certified, KC and CE Marked for all applicable directives
Power Supply	24V DC ±15%
Safety Output	2 OSSDs (max. 0.5 A)
Enclosure Rating	IP65
Cross Section	30 x 30 mm (1.19 x 1.19 in.)
Scanning Range	Resolution 14 mm (0.56 in.): 0.5...4 m (1.64...13.12 ft) Resolution 30 mm (1.19 in.): 0.9...7.0 m (2.95...22.97 ft)

Accessories

Description	Catalog Number
M12 5-pin cable ¹	889D-F5BC-⊗
M12 8-pin cable ¹	889D-F8AB-⊗
Optical interface tool (required if using Connected Components Workbench software for diagnostic information)	450L-AD-0ID
Weld shield kit ²	450L-AW-xxxx
Laser alignment tool	440L-ALAT
Mounting bracket for laser alignment tool	450L-ALAT-C
Side mounting bracket kit	450L-AM-SM
Muting Distribution Block	450L-AMOD-AMUT-8
Muting Station	800F-MUT-2-MS
Muting Status Lamp	450L-AMUT-IL

⊗ The catalog number as listed is incomplete. Replace the ⊗ with **2** (6.6 ft), **5** (16.4 ft), **10** (32.8 ft), **15** (49.2 ft), **20** (65.6 ft), or **30** (98.4 ft) for available lengths in meters.

¹ Required Accessory

² **xxxx** = 0150 ... 1950 mm (0.5 ... 6.4 ft) in increments of 150 mm (0.5 ft).



Presence Sensing Safety Devices

SAFETY

GuardShield™ POC Type 4 Safety Light Curtain 450L-E

- Point of Operation Control (POC) for finger or hand protection
- Innovative plug-in modules (purchased separately) enables functionality for muting, blanking and cascading
- Protection heights 150...1950 mm (5.9...76.7 in.) in increments of 150 mm (0.5 ft)
- Integrated laser alignment system helps provide quick and more reliable installation
- TÜV certified Plc, Type 4 IEC 61496-1/-2, SILCL3 per EN ISO 13849-1, IEC 62061



An Enhanced light curtain with advanced functions and EtherNet/IP™ connectivity

The GuardShield 450L-E Safety Light Curtain system is the enhanced version of the GuardShield 450L-B Safety Light Curtain system. It offers a larger operating range and each stick has a integrated laser alignment feature which allows a quick and more reliable installation. Functionalities like blanking, muting or cascading can be integrated. This advanced modular technology greatly reduces stock and helps provide a flexible, cost-effective safety solution. Plus, connection over EtherNet/IP makes the light curtain a smart safety device that enhances safety and delivers diagnostics while providing connectivity through The Connected Enterprise®.

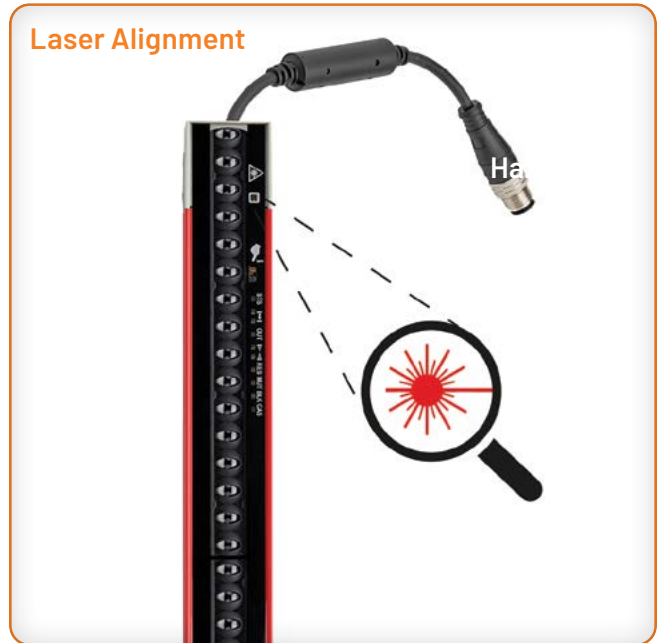

Presence Sensing Devices



5-4...5-19

Interlock Switches



5-20...5-39

Access Control



5-40...5-41

Safety Relays



5-42...5-47

Emergency Stop Devices



5-48...5-49

Safety Limit Switches



5-50...5-51

Product Selection

Light Curtain System: Order two identical transceivers/catalog numbers

Description	Catalog Number ¹
Transceiver with finger resolution. 14 mm (0.55 in.) resolution. Top and bottom mounting kit included ²	450L-E4FLxxxxYD
Transceiver with hand resolution. 30 mm (1.18 in.) resolution. Top and bottom mounting kit included ²	450L-E4HLxxxxYD

¹ **xxxx** = 0150 ... 1950 mm (0.5 ... 6.4 ft) in increments of 150 mm (0.5 ft).

For example: "450L-E4FL**0900**YD" indicates an order for 900 mm finger detection light curtain transceiver stick.

² Optional side mounting bracket kit is available below.

Plug-in Modules: Order one transmitter and one receiver plug-in with the desired functionality for one system – **or** – Order two universal plug-ins for one system. Each universal plug-in can be used as a transmitter or a receiver.

Description	Catalog Number
Transmitter plug-in, M12 5-pin	450L-APT-PW-5
Receiver plug-in, M12 5-pin, On/Off	450L-APR-ON-5
Transmitter plug-in, M12 8-pin ³	450L-APT-PW-8
Receiver plug-in, M12 8-pin, reset mode, EDM, scanning range	450L-APR-ED-8
Receiver plug-in, M12 5-pin, blanking	450L-APR-BL-5
Receiver plug-in, M12 8-pin, muting, blanking, reset mode, EDM, scanning range	450L-APR-MU-8
Cascading plug-in, M12 8-pin, serial connection of light curtain sticks	450L-APC-IO-8
Universal plug-in, M12 8-pin, reset mode, EDM, scanning range ⁴	450L-APU-UN-8
Receiver plug-in, M12 8-pin CIP Safety over EtherNet/IP™ ⁵	450L-APR-EN-8

³ The 8-pin transmitter plug-in option allows two 8-pin cordsets to be used in one system.

⁴ Order two universal plug-ins for one system. Each universal plug-in can be used as a transmitter or a receiver.

⁵ 450L-ENETR Network Interface Module is also required.

Specifications

Standards	Type 4 (IEC 61496), PLe Cat 4 (ISO 13849-1), SIL CL3 (IEC 62061)
Certifications	UL Listed, TUV Certified, KC and CE Marked for all applicable directives
Power Supply	24V DC ±15%
Safety Output	2 OSSDs (max. 0.5 A)
Enclosure Rating	IP65
Cross Section	30 x 30 mm (1.19 x 1.19 in.)
Scanning Range	Resolution 14 mm (0.56 in.): 0.5...9 m (1.64...29.53 ft) Resolution 30 mm (1.19 in.): 0.9...16.2 m (2.95...53.15 ft)

Accessories

Description	Catalog Number
M12 5-pin cable ¹	889D-F5BC-⊗
M12 8-pin cable ¹	889D-F8AB-⊗
Optical interface tool (required if using Connected Components Workbench software for diagnostic information)	450L-AD-0ID
Weld shield kit ²	450L-AW-xxxx
Laser alignment tool	440L-ALAT
Mounting bracket for laser alignment tool 440L-ALAT	450L-ALAT-C
Side mounting bracket kit	450L-AM-SM
Termination plug, M12 8-pin for cascading plug-in	898D-81CU-DM
Muting Distribution Block	450L-AMOD-AMUT-8
Muting Station	800F-MUT-2-MS
Muting Status Lamp	450L-AMUT-IL

⊗ The catalog number as listed is incomplete. Replace the ⊗ with **2** (6.6 ft), **5** (16.4 ft), **10** (32.8 ft), **15** (49.2 ft), **20** (65.6 ft), or **30** (98.4 ft) for available lengths in meters.

¹ Required Accessory

² **xxxx** = 0150 ... 1950 mm (0.5 ... 6.4 ft) in increments of 150 mm (0.5 ft).



Presence Sensing Safety Devices

SAFETY

GuardShield™ POC Type 4 Safety Light Curtain 440L

- Point of Operation Control (POC) for finger or hand protection
- Heavy-duty IP65 housing
- Wide operating range 0.3...16 m (0.98...52.49 ft)
- Dip switch selectable functions: blanking (including teach-in), beam coding, EDM (External Device Monitoring), and start mode
- Available options: cascading, integrated laser alignment, ArmorBlock® Guard I/O™ connectivity

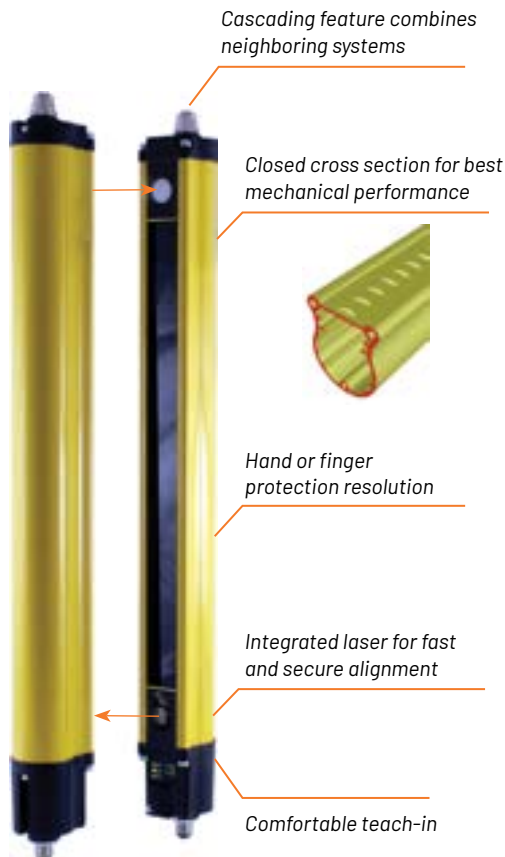

A Robust Solution for Finger and Hand Detection

GuardShield safety light curtains offer an extraordinary robustness against high-mechanical impacts. The unique profile design is a perfect solution for heavy duty applications. An integrated laser feature allows for easy set up and a comfortable control of the alignment. With these features this product helps to provide the highest reliability.



Presence Sensing Devices



5-4...5-19

Interlock Switches



5-20...5-39

Access Control



5-40...5-41

Safety Relays



5-42...5-47

Emergency Stop Devices



5-48...5-49

Safety Limit Switches



5-50...5-51

Product Selection

GuardShield™ POC Type 4

Description	Cat. No.	
	Finger Resolution (14 mm)	Hand Resolution (30 mm)
GuardShield Type 4	440L-P4JxxxxYD ¹	440L-P4KxxxxYD ¹
GuardShield Type 4 with laser	440L-P4JLxxxxYD ²	440L-P4KLxxxxYD ²
GuardShield Type 4 cascading	440L-C4JxxxxYD ³	440L-C4KxxxxYD ³
GuardShield Type 4 cascading with laser	440L-C4JLxxxxYD ²	440L-C4KLxxxxYD ²
GuardShield Type 4 Teach-in	440L-S4JxxxxYR	440L-S4KxxxxYR
GuardShield Type 4 Armor with laser	440L-P4JLxxxxYA ²	440L-P4KLxxxxYA ²

¹ Models are available in protective heights from 160...1760 mm (6.3...69.3 in.) in 160 mm increments. To order, replace the **xxxx** in the catalog number with the protective height in mm. For example, to order 160 mm height, replace the **xxxx** with **0160** (440L-P4K**0160**YD), or for 1760 mm height, replace **xxxx** with **1760** (440L-P4K**1760**YD).

² Models are available in protective heights from 320...1600 mm (12.6...63 in.) in 160 mm (6.3 in.) increments.

³ Models are available in protective heights from 320...1760 mm (6.3...69.3 in.).

Specifications

Standards	Type 4 (IEC 61496), PLe Cat 4 (ISO 13849-1), SIL CL3 (IEC 62061)
Certifications	UL Listed, TÜV Certified, and CE Marked for all applicable directives
Power Supply	24V DC ±20%
Safety Output	2 OSSDs (max. 0.5 A)
Enclosure Rating	IP65
Cross Section	40 x 50 mm (1.57 x 1.96 in.)
Scanning Range	Finger: 0.3...7 m (0.98...22.9 ft) Hand: 0.3...16 m (0.98...52 ft)

Required Cordsets & Accessories

Description	Cat. No.
4-pin straight transmitter cable	889D-F4AC-2 ⁴
8-pin straight receiver cable	889D-F8AB-2 ⁴
Vertical shock mounting kit	440L-AF6120
Horizontal shock mount kit	440L-AF6121
Weld Shield	440L-AGWSxxxx ¹
IP67 washdown enclosure kit (limited offering) ⁷	440L-AGSTxxxx ^{1,6}
Mirror 75 mm (2.95 in.)	440L-AM075yyyy ⁵
Mirror 125 mm (4.92 in.)	440L-AM125yyyy ⁵
Muting box	445L-AMUTBOX1

¹ Models are available in protective heights from 160...1760 mm (6.3...69.3 in.) in 160 mm increments. To order, replace the **xxxx** in the catalog number with the protective height in mm. For example, to order 160 mm height, replace the **xxxx** with **0160** (440L-P4K**0160**YD), or for 1760 mm height, replace **xxxx** with **1760** (440L-P4K**1760**YD).

⁴ Replace the **2** with **5, 10, 15, 20, or 30** for available lengths in meters.

⁵ **yyyy** = mirror length in mm

⁶ 440L-AGSTxxxx is only available for the standard i.e. non-laser model in the following sizes: 320, 480, 640, 800, 960.

⁷ Washdown enclosure kits are not compatible with 440L models with integrated laser alignment.

Note: For additional information, see Safety Connection Systems (page 4-50).



Need Help?

The Rockwell Automation Support Center is your 24/7 support for the answers you need now.

<https://rok.auto/support>



Presence Sensing Safety Devices

SAFETY

Micro 400 POC Type 4 Safety Light Curtain 445L

- Point of Operation Control (POC) for finger or hand protection
- Slim housing
- Economical three-box system
- Requires MSR41 or MSR42 controller
- IP54 enclosure rating
- No dead zone
- TÜV Certified



A Slim-profile Solution for Point of Operation Control

Micro 400 are Type 4 safety light curtains with an extremely small profile of 15 x 20 mm (0.59 x 0.78 in.) and are available with both finger and hand resolution. They are designed to be built *into* the machine and not on the machine. This product must be used in combination with an MSR41 or MSR42 controller. The MSR42 controller is multi-functional and allows for additional functions like blanking, override, and muting.

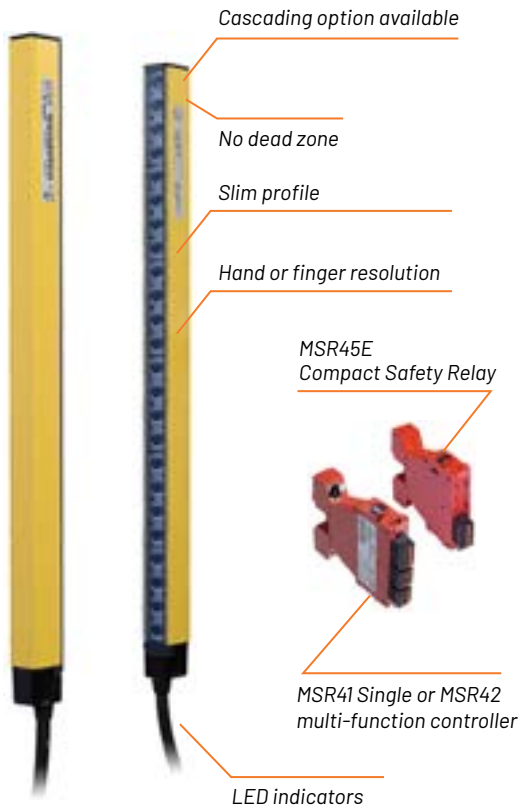

Typical Application



Presence Sensing Devices



5-4...5-19

Interlock Switches



5-20...5-39

Access Control



5-40...5-41

Safety Relays



5-42...5-47

Emergency Stop Devices



5-48...5-49

Safety Limit Switches



5-50...5-51

Product Selection

Micro 400 POC Type 4

Description	Cat. No. ¹	
	Finger Resolution (14 mm)	Hand Resolution (30 mm)
Micro 400	445L-P4CxxxxFP	445L-P4ExxxxFP
Micro 400 cascaded	445L-C4CxxxxFP ²	445L-C4ExxxxFP ²
Micro 400 IP69K	445L-P4CxxxxKP ²	-

¹ Models are available in protective heights from 50...1200 mm (2.0...47.2 in.) in 50 mm increments. To order, replace the **xxxx** in the catalog number with the protective height in mm. For example, to order 600 mm height, replace the **xxxx** with **0600** (445L-P4C**0600**FP), or for 1200 mm height, replace **xxxx** with **1200** (445L-P4C**1200**FP).

² Not all protective heights.

Specifications

Standards	Type 4 (IEC 61496-1, -2), PLe Cat 4 (ISO 13849-1), SIL CL3 (IEC 62061)
Certifications	UL Listed, TÜV Certified, and CE Marked for all applicable directives
Enclosure Rating	IP54
Cross Section	15 x 20 mm (0.59 x 0.79 in.)
Scanning Range	Finger: 0...5 m (0...16.4 ft) Hand: 0...5 m (0...16.4 ft)
Power Supply	24V DC ±20%
Safety Output	2 OSSDs (max. 0.4 A each)

Required Cordsets & Accessories

Description	Cat. No.
Transmitter/receiver connection cable	445L-AC8RJ1 ³
Transmitter/receiver patchcord cable	445L-AC8PC1 ⁴
Flat mount kit	445L-AF6145
Adjustable flat mounting kit	445L-AF6149
MSR41 controller	440R-P221AGS
MSR42 controller	440R-P226AGS-NNR
MSR45E relay (2 N.O.)	440R-P4NANS
Ribbon cable for one MSR45E	440R-ACABL1
Muting box	445L-AMUTBOX1

³ Replace the **1** with **2**, **3**, **5**, or **8** for other available meter lengths.

⁴ Replace the **1** with **3** or **5** for other available meter lengths.



Product Selection Tools

Available online or for download, our tools help you access info while in the office or on the go.

<https://rok.auto/selection>



Presence Sensing Safety Devices

SAFETY

GuardShield™ PAC Type 4 & Safe 4/Micro 400 Safety Light Curtain 440L

- Perimeter Access Control (PAC) for whole body detection around machines
- Two-, three-, and four-beam solution
- Integrated laser alignment tool
- Long operating range
- cULus Listed and TÜV Certified

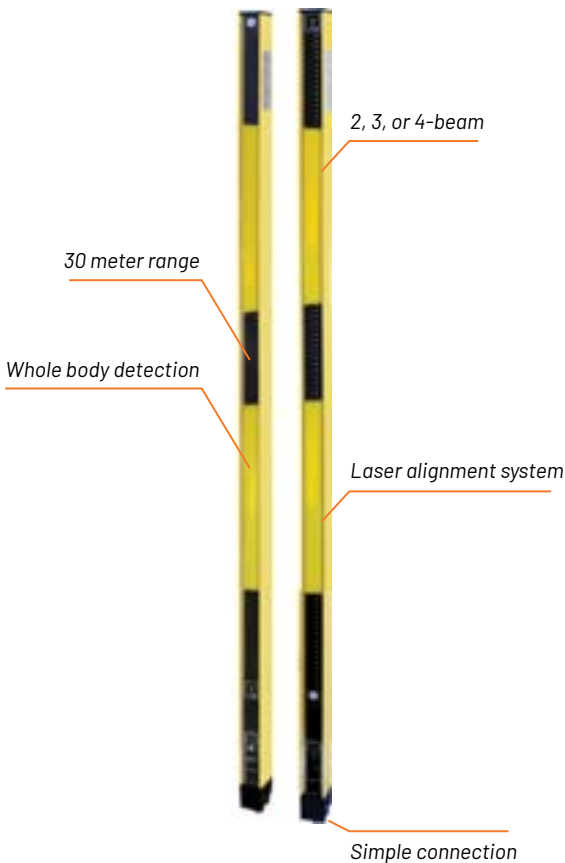

Whole-body Detection for Machine Perimeter Safeguarding

Based on the individual safety light curtain platforms and perimeter access control (PAC), these safety light curtains are used for whole-body detection. They are typically positioned around an area or in front of a machine process entry or exit area. Multi-sided access control is attained through the use of corner mirrors. The integrated laser alignment tool makes the set up with mirrors most efficient.

Typical Application

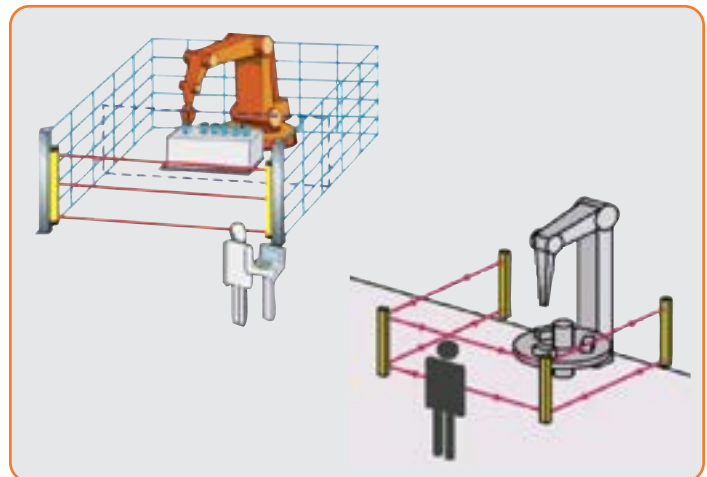

Presence Sensing Devices



5-4...5-19

Interlock Switches



5-20...5-39

Access Control



5-40...5-41

Safety Relays



5-42...5-47

Emergency Stop Devices



5-48...5-49

Safety Limit Switches



5-50...5-51

Product Selection

GuardShield™ PAC Type 4 & Safe 4/Micro 400

	Description	Cat. No.		
		2-Beam	3-Beam	4-Beam
GuardShield Type 4	PAC	440L-P4A2500YD	440L-P4A3400YD	-
	PAC with Laser	440L-P4AL2500YD	440L-P4AL3400YD	-
	PAC ArmorBlock® with Laser	440L-P4AL3400YA	440L-P4AL3400YA	-
Safe 4	PAC (short working range)	445L-103002-0048	445L-103002-0003	445L-103002-0007
	PAC (long working range)	445L-P4S2500YD	445L-P4S3400YD	445L-P4S4120YD
Micro 400	PAC	445L-110492-0002	445L-110492-0004	445L-110492-0006

Specifications

	GuardShield Type 4 PAC	Safe 4 PAC	Micro 400 PAC
Profile Cross Section	40 x 50 (1.57 x 1.97 in.)	30 x 40 (1.18 x 1.57 in.)	15 x 20 (0.59 x 0.79 in.)
Working Range	0.3...16 m (0.98...52.5 ft)	0...18 m (0...59.05 ft) 5...30 m (16.4...98.4 ft)	0...5 m (0...16.4 ft)
Enclosure Type Rating	IP65	IP65	IP54
Integrated Laser Alignment	Optional	Standard	-
5-pin ArmorBlock	Optional	Standard	-
Integrated Controller	Yes	Yes	MSR41/MSR42
Beam Coding	Yes	No	No
EDM	Yes	No	Yes
Configuration	Dip switch	No	MSR42 wiring or software
Safety	Type 4 (IEC 61496-1, -2); PLe Cat 4 (ISO 13849-1); SIL CL3 (IEC 62061)		
Aux. Output (Non-safety)	1 PNP, 0.5 A max.	No	2 PNP, 0.2 A max.
Operating Temperature [C (F)]	-10...+55 ° (14...131 °)	0...55 ° (32...131 °)	0...55 ° (32...131 °)

Required Cordsets & Accessories

GuardShield Type 4

Description	Cat. No.
4-pin straight transmitter cable	889D-F4AC-2 ²
8-pin straight receiver cable	889D-F8AB-2 ²
Vertical shock mounting kit	440L-AF6120
Horizontal shock mount kit	440L-AF6121
Weld Shield	440L-AGWSxxxx ¹
IP67 washdown enclosure kit (limited offering) ⁵	440L-AGSTxxxx ¹

Safe 4

Description	Cat. No.
Transmitter/receiver cable: 5-pin straight	889D-F5AC-2 ²
Transmitter/receiver cable: 5-pin straight, shielded	889D-F5EC-2 ²
180° adjustable mounting kit	445L-AF6141
Shock mount kit	445L-AF6142
Mounting stand	440L-AMSTD
Mirror 75 mm (2.95 in.)	440L-AM075yyyyy ³
Mirror 125 mm (4.92 in.)	440L-AM125yyyyy ³

Micro 400

Description	Cat. No.
Transmitter/receiver cordset	445L-AC8RJ1 ³
Transmitter/receiver patchcord	445L-AC8PC1 ⁴
180° adjustable mounting kit	445L-AF6143
Flat mount kit	445L-AF6145
Adjustable flat mounting kit	445L-AF6149
MSR41 controller	440R-P221AGS
MSR42 controller	440R-P226AGS-NNR
MSR45 relay (2 N.O.)	440R-P4NANS

¹ Replace **xxxx** for protective height.

² Replace the **2** with **5, 10, 15, 20,** or **30** for other available lengths in meters.

³ Replace the **1** with **2, 3, 5,** or **8** for other available meter lengths.

⁴ Replace the **1** with **3** or **5** for other available meter lengths.

⁵ Washdown enclosure kits are not compatible with 440L models with integrated laser alignment.

Note: For additional information, see Safety Connection Systems (page 4-50).



Presence Sensing Safety Devices

SAFETY

SafeZone™ Safety Laser Scanners 442L

- Singlezone, Multizone, Mini and EtherNet/IP versions
- Selectable resolutions of 30...200 mm
- Horizontal or vertical mounting
- Stationary or mobile applications
- SafeZone 3 AOP for integration to safety logix system
- Rugged IP65 housings
- Scanning angles of 190°, 270° and 275°
- Seven-segment diagnostic display, rotatable by 180°
- EtherNet/IP version has colored text display



EtherNet/IP



SafeZone 3

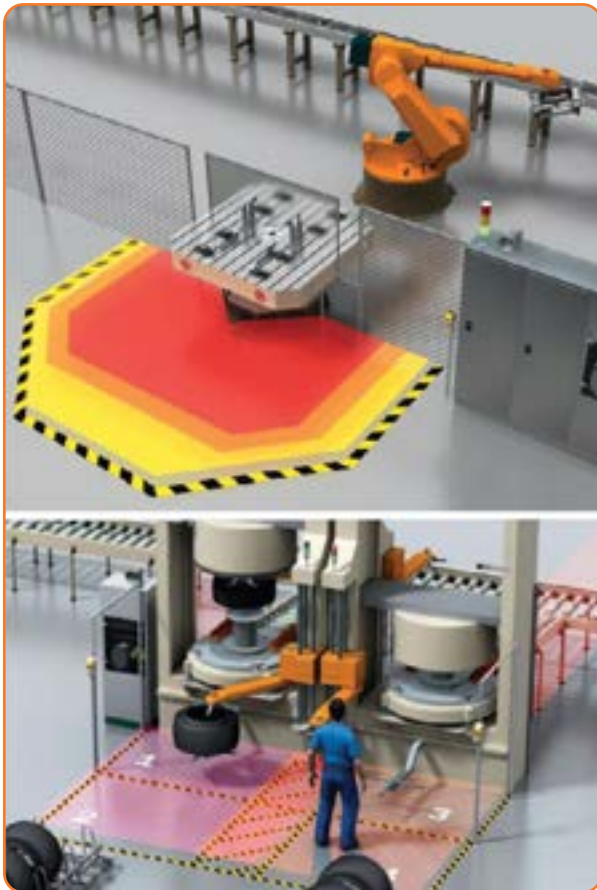

A Flexible, Easy-to-Use Machine Safeguarding Solution

SafeZone safety laser scanners are Type 3 optoelectronic devices that use reflection of emitted infrared light to detect a person or object within a user-defined area. The Class 1 (eye safe) infrared laser scans a 190° to 275° angular area to create a two-dimensional detection field. Light reflected off an object or person in the field is processed by the SafeZone, which sends a stop signal to the machine or to the safety controller.

SafeZone Multizone has up to four configurable, switchable field sets (Safety and Warning). Two field sets can be simultaneously monitored.

SafeZone 3 has up to eight configurable fields, four safety and four warning, Up to four fields can be simultaneously monitored.

SafeZone 3

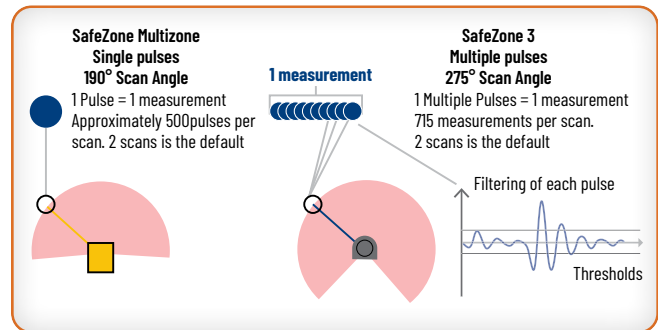

Presence Sensing Devices



5-4...5-19

Interlock Switches



5-20...5-39

Access Control



5-40...5-41

Safety Relays



5-42...5-47

Emergency Stop Devices



5-48...5-49

Safety Limit Switches



5-50...5-51

Product Selection

SafeZone™ Safety Laser Scanners

Model	Application Specific Resolutions	Safety Outputs	Auxiliary Outputs	Angular Scanning Range	Safety Field Range	Cat. No.
SafeZone Mini: 2M&3M	30, 40, 50, 70, 150* mm	2 OSSDs	Two Configurable	270°	2 m, 3 m	42L-SFZNMN 442L-SFZNMN3
SafeZone Singlezone	30, 40, 50, 70, 150 mm	2 OSSDs	One	190°	4 m	442L-SFZNSZ
SafeZone Multizone	30, 40, 50, 70, 150 mm	2 OSSDs	One	190°	5 m	442L-SFZNMZ
SafeZone 3	30, 40, 50, 70, 150, 200 mm	4 Safety Bits	N/A	275°	5.5 m	442L-SZNMZCP

¹ SafeZone Mini 3M only.

Required Parts for Singlezone, Multizone, SafeZone 3

Model	Description	Catalog Number
SafeZone Singlezone and Multizone	Prewired memory module, 10 or 20 m cable length	442L-CSFZNMZ-10 or 442L-CSFZNMZ-20
SafeZone 3	Memory Module	442L-SZNCPMOD

Required Cable & Cordsets

Description	Cat. No.
Mini Scanner Cable: 8 pin M12 qd cordset, 2.5, 10, 20 m	442L-ACABL2 442L-ACABL10 442L-ACABL20
Singlezone, Multizone and Mini programming cable 2 m, 10 m	442L-ACUSB-2 442L-ACUSB-10
SafeZone 3 Power Cable -F is Straight, -R is Right angle	889D-F4AC-x ² 889D-R4AC-x ²
SafeZone 3 EtherNet Cables M12 to Flying leads M12 to M12 M12 to M12 Cat. 5 M12 to RJ45	1585D-M4UB-x ² 1585D-M4UBDM-x ² 1585D-M4UBDE-x ² 1585D-M4UBJM-x ²

² x is 2, 5 or 10 m standard lengths.

Mounting Brackets

Singlezone or Multizone

Description	Cat. No.
Mounting kit 1: bracket for direct mounting at the rear of the scanner	442L-AMBSFZNMZ1
Mounting kit 2: mounts to bracket 1 only, horizontal adjustment.	442L-AMBSFZNMZ2
Mounting kit 3: mounts to bracket 1 and bracket 2 only, wall or floor mount	442L-AMBSFZNMZ3

SafeZone Mini

Description	Cat. No.
Mounting kit 1: mounts to scanner body	442L-AMBSZMN1
Mounting kit 2: mounts to scanner body with protection for optic window	442L-AMBSZMN2
Mounting kit 3: mounts to either mounting bracket 1 or bracket 2	442L-AMBSZMN3
Mounting kit 4: mounts to either mounting bracket 1 and 3 or bracket 2 and 3	442L-AMBSZMN4

SafeZone 3

Description	Cat. No.
Mounting kit 1: mounts to housing	442L-AMBSZCP1
Mounting kit 2: mounts to housing with protection for optic window	442L-AMBSZCP2
Mounting kit 3: mounts to bracket 1 or 2. Used when the system plug is installed on the bottom side of the safety laser scanner.	442L-AMBSZCP3
Mounting kit 4: mounts to bracket 1 or 2. Used when the system plug is installed on the rear side of the safety laser scanner.	442L-AMBSZCP4



Presence Sensing Safety Devices

SAFETY

SC300 Safety Sensor 442L

- Compact hand detection system
- 110° field of view
- Automatic alignment
- No programming software required
- Horizontal or vertical mounting
- Integrated EDM, Restart/Reset and Teach-in
- IP54 industrial-grade housing



Cost-effective, Vision-based Machine Guarding

The Guardmaster® SC300 is a compact hand detection safety sensor system, which operates based on image processing technology. The SC300 compares a two-dimensional image against a passive pattern, i.e., the background. Detection is based on an object of a certain resolution blocking the sensor's view of the pattern.

This Type 3 vision-based protective device is designed for use in certain machine-guarding applications where reflective tape can be attached to a square or rectangular frame to define the detection boundaries.

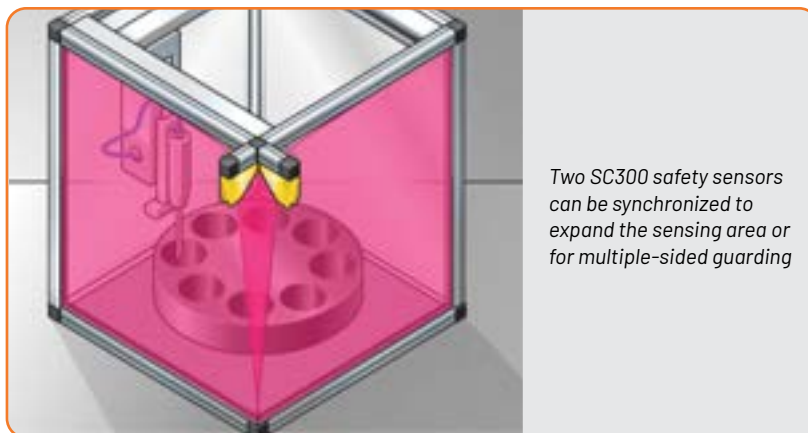

Two SC300 safety sensors can be synchronized to expand the sensing area or for multiple-sided guarding

Presence Sensing Devices



5-4...5-19

Interlock Switches



5-20...5-39

Access Control



5-40...5-41

Safety Relays



5-42...5-47

Emergency Stop Devices



5-48...5-49

Safety Limit Switches



5-50...5-51

Product Selection

SC300 Safety Sensor

Description	Cat. No.
Guardmaster SC300 safety sensor	442L-SAFCAM1

Specifications

Standards	EN 61496-1, EN 61508, EN ISO 13849-1
Safety Classification	Cat 3 ISO 13849-1; Type 3 IEC 61496-1; SIL 2 IEC 61508, SIL cl2 IEC 62061; PLd ISO 13849-1
Certifications	cULus Listed, TÜV Certified, CE Marked for all applicable directives
Power Supply	24V DC \pm 20%
Power Consumption	4 W (24V no load), 19 W (max. output load)
Safety Outputs	2 OSSD. 0.25 A, short-circuit protected, cross fault monitored
Resolution	24 and 30 mm (based on tape kit used)
Operating Range	2.12 m (6.94 ft) max.
Sensing Area	Up to 1.5 x 1.5 m (4.92 x 4.92 ft) ¹

¹ It is possible to synchronize two SC300 safety sensors to increase the maximum monitored area to 1.5 x 3.0 m (4.92 x 9.84 ft).

Required Accessories

Description	Cat. No.
Reflective tape kit, 2 pcs of 1.5 m strips, 24 mm resolution with test rod	442L-ACAM24MMKIT
Reflective tape kit, 2 pcs of 1.5 m strips, 30 mm resolution with test rod	442L-ACAM30MMKIT

Accessories

Description	Cat. No.
Mounting brackets (2 brackets per kit includes 2 - M6 stainless steel socket head screws)	442L-ACAMBRK1
Teach-in stylus (1 pc supplied with each SC300)	442L-ACAMTS
Test rod 24 mm resolution (1 pc supplied with each 24 mm tape kit)	442L-ATRD24MM
Test rod 30 mm resolution (1 pc supplied with each 30 mm tape kit)	442L-ATRD30MM



Safety

Our innovative safety products and solutions improve the functional operation of your machinery while helping to increase personnel safety, efficiency and productivity.

<https://rok.auto/safety-products>



Presence Sensing Safety Devices

SAFETY

Safety Mat System 440F

- Pressure-sensitive protective device per EN ISO 13856-1 for machine safeguarding
- Hardened steel plate construction
- No dead spots
- Four-wire system to detect opens and shorts
- Withstands 4500 psi static pressure
- IP67 rated
- PLd per ISO 13849-1 when used with a suitable safety control

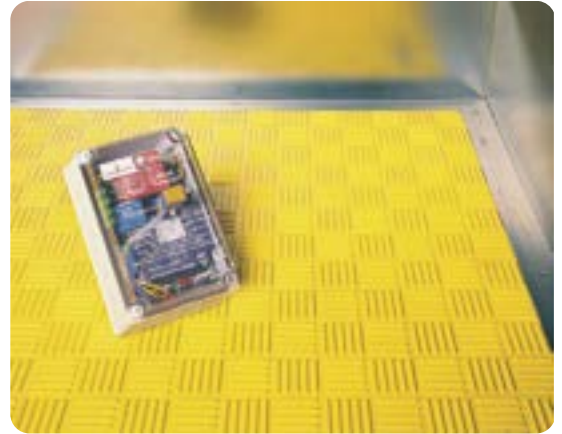

Anatomy of a Safety Mat System

When integrated to a suitable safety mat controller, it detects a presence on the mat, a short circuit, or an open circuit. Under each of these conditions, the safety control issues a stop command. Multiple mats can be combined into one safety mat system with the use of joining trim.

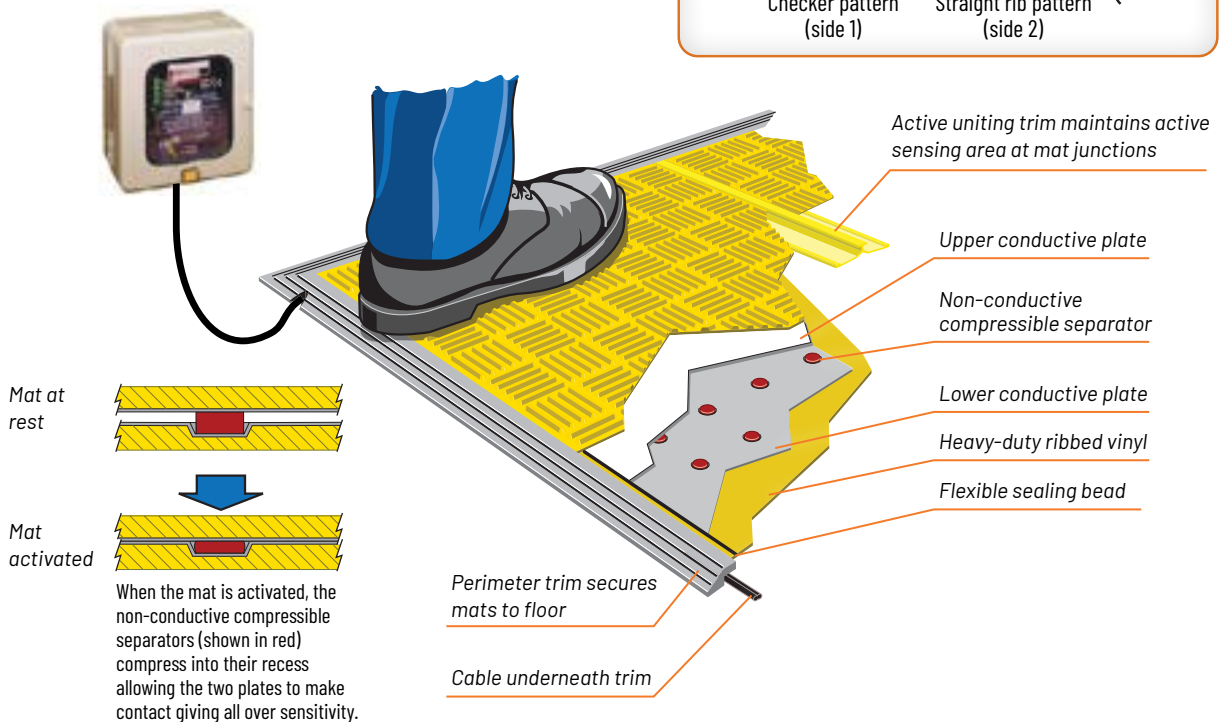
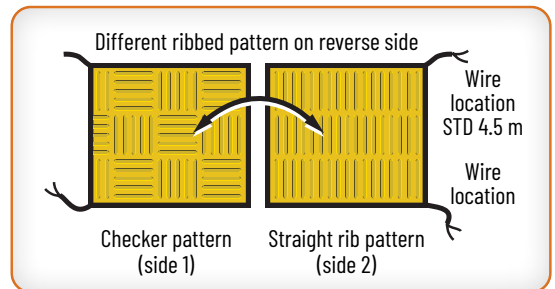

Presence Sensing Devices



5-4...5-19

Interlock Switches



5-20...5-39

Access Control



5-40...5-41

Safety Relays



5-42...5-47

Emergency Stop Devices



5-48...5-49

Safety Limit Switches



5-50...5-51

Product Selection

Safety Mats

Mat Size [mm (in.)]	Cat. No.	
	Standard Perimeter Trim Kit	Safety Mat
500 x 500 (19.7 x 19.7)	440F-T1010	440F-M1010BYNN
500 x 1500 (19.7 x 59.1)	440F-T1030	440F-M1030BYNN
750 x 1500 (29.5 x 59.1)	440F-T1530	440F-M1530BYNN
1000 x 1000 (39.4 x 39.4)	440F-T2020	440F-M2020BYNN
1000 x 1250 (39.4 x 49.2)	440F-T2025	440F-M2025BYNN
1000 x 1500 (39.4 x 59.1)	440F-T2030	440F-M2030BYNN
1000 x 1800 (39.4 x 70.9)	440F-T2036	440F-M2036BYNN

Mat Control

Description	Cat. No.
MSR safety relay	440R-C23139
GSR SI (single input) safety relay	440R-S12R2
Multi-mat control (up to 8 sensor mats)	440F-C280114
440C-CR30 configurable safety relay	440C-CR30-22BBB

Specifications

Standards	ISO 13856-1, ISO 13849-1
Safety Classification	Mat(s), connection cabling, and suitable mat safety control can achieve: SIL CL 2 per IEC 62061, PLd per ISO 13849-1
Functional Safety Data	Visit https://rok.auto/safety-sr001
Certifications	cULus Listed, TÜV Certified, and CE Marked for all applicable directives https://rok.auto/certifications
Power Supply	24V DC, -20% +10%, provided by the control unit
Mechanical Life	1,000,000 operations

Required Cordsets & Accessories

Description	Cat. No.	
	4-Pin	5-Pin
Cordset	889D-F4AC-2 ¹	889D-F5AC-2 ¹
Patchcord	889D-F4ACDM-1 ²	889D-F5ACDM-1 ²
Distribution Box	898D-4 ³ LT-DM4	-
Shorting Plug	898D-41LU-DM	-
T-Port	898D-43LY-D4	-
Trim		Cat. No.
2 m perimeter trim with square end (up to 3 cables through channel)		440F-T3210
External corner perimeter trim for use with 440F-T3210 (up to 3 cables through channel)		440F-T3012
Internal corner perimeter trim for use with 440F-T3210 (up to 3 cables through channel)		440F-T3013
2 m, 2 part perimeter trim with square end (up to 8 cables through channel)		440F-T3211
External corner trim for use with 440F-T3211 (up to 8 cables through channel)		440F-T3014
Internal corner trim for use with 440F-T3211 (up to 8 cables through channel)		440F-T3015

Note: All perimeter trim features aluminum construction.

¹ Replace the **2** with **5** or **10** for available lengths in meters.

² Replace the **1** with **OM3**, **5**, or **10** for other available lengths in meters.

³ Replace with **4** or **8** for number of ports available.

⁴ Other 440F-C280xx controllers available with different voltages, connector types for Mats and Power. Please see technical data for additional catalog numbers.

Note: For additional information, see Safety Connection Systems (page 4-50).



440F Safedge™

- Conductive rubber technology
- Various profiles and cushion factors
- Up to 50 m lengths
- Aluminum, plastic, or zinc-coated steel mounting rails



Interlock Switches

SAFETY

SensaGuard™ Non-Contact Switches 440N

- PLe Cat 4 per ISO 13849-1 (safety performance is maintained when connected in series)
- Type 4 interlocking device per ISO 14119 with low or high coded RFID actuators
- Standard, magnetic hold, and integrated latch versions
- IP69K washdown rating



Non-contact Machine Safeguarding with RFID Technology

Featuring RFID technology for coding, inductive technology for sensing and combining a large sensing range with optimal operation and a generous tolerance to misalignment, SensaGuard switches offer a cost-effective solution that is ideally suited to a wide range of safety applications and is intended for use with all types of guard doors.

Rectangular Flat Pack Version

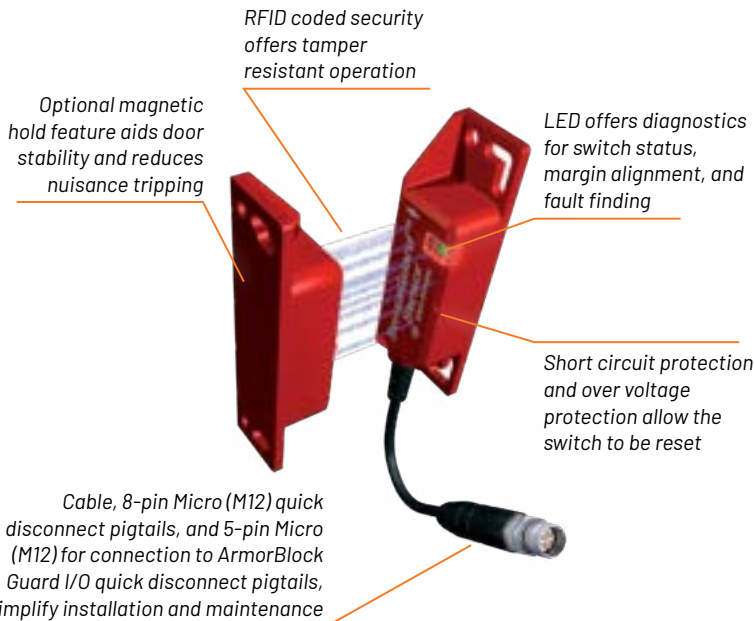

Integrated Latch Version



Presence Sensing Devices



5-4...5-19

Interlock Switches



5-20...5-39

Access Control



5-40...5-41

Safety Relays



5-42...5-47

Emergency Stop Devices



5-48...5-49

Safety Limit Switches



5-50...5-51

Product Selection

SensaGuard™ Non-Contact Switches

Type	Assured Sensing Distance	Margin Indication	Magnetic Hold	Actuator Code Type	Cat. No.		
					Cable		Connector
					3 m	10 m	6 inch Pigtail, 8-pin Micro (M12) ¹
18 mm plastic barrel/18 mm actuator	On: 15 mm (0.59 in.)	-	-	Standard	440N-Z21S16A	440N-Z21S16B	440N-Z21S16H
	Off: 25 mm (0.98 in.)	-	-	Unique	440N-Z21U16A	440N-Z21U16B	440N-Z21U16H
18 mm plastic barrel/30 mm actuator	On: 25 mm (0.98 in.)	-	-	Standard	440N-Z21S26A	440N-Z21S26B	440N-Z21S26H
	Off: 35 mm (1.38 in.)	-	-	Unique	440N-Z21U26A	440N-Z21U26B	440N-Z21U26H
18 mm stainless steel barrel/18 mm actuator	On: 10 mm (0.39 in.)	-	-	Standard	440N-Z21S17A	440N-Z21S17B	440N-Z21S17H
	Off: 20 mm (0.79 in.)	-	-	Unique	440N-Z21U17A	440N-Z21U17B	440N-Z21U17H
Plastic rectangular/ rectangular actuator	On: 15 mm (0.59 in.)	-	-	Standard	440N-Z21SS2A	440N-Z21SS2B	440N-Z21SS2H
				Unique	440N-Z21US2A	440N-Z21US2B	440N-Z21US2H
	Off: 25 mm (0.98 in.)	Yes	-	Standard	440N-Z21SS2AN	440N-Z21SS2BN	440N-Z21SS2HN
				Unique	440N-Z21US2AN	440N-Z21US2BN	440N-Z21US2HN
	Yes	Yes (9 N)	Standard	440N-Z21SS2AN9	440N-Z21SS2BN9	440N-Z21SS2HN9	
			Unique	440N-Z21US2AN9	440N-Z21US2BN9	440N-Z21US2HN9	
Plastic housing with integrated latch	On: Contact/latched	-	Adjustable 20...60 N	Standard	440N-Z21SS3PA	440N-Z21SS3PB	440N-Z21SS3PH
	Off: 32 mm (1.26 in.)			Unique	440N-Z21SU3PA	440N-Z21SU3PB	440N-Z21SU3PH

¹ For 5-pin Micro (M12) connector for connection to ArmorBlock Guard I/O, replace the **H** in the catalog letter with **J**.

Specifications

Standards	ISO 14119, IEC 60947-5-3, IEC 61508, EN ISO 13849-1
Safety Classification	Type 4 Interlocking Device per ISO 14119 (Unique/ High and Standard/ Low Coding), PLe Cat 4 per ISO 13849-1
Functional Safety Data	Visit https://rok.auto/safety-sr001
Certifications	cULus Listed (UL 508), TÜV Certified, and CE Marked for all applicable directives https://rok.auto/certifications

Required Cordsets & Accessories

Description	Cat. No.
Cordset	889D-F8AB- ²
Patchcord	889D-F8ABDM- ³
Safety wired T-port	898D-438Y-D8
Safety wired shorting plug	898D-418U-DM

² Replace symbol with **2**, **5**, or **10** for standard cable lengths in meters.

³ Replace symbol with **1**, **2**, **3**, **5**, or **10** for standard lengths in meters.

Note: For 5-pin Micro (M12) connector use 889D-F5ACDM-2.

Note: For additional information, see Safety Connection Systems (page 4-50).



Interlock Switches

SAFETY

Magnetically Coded Non-Contact Switches 440N

- Non-contact actuation
- Magnetic coded sensing
- Small size
- Molded-in mounting brackets
- High tolerance to misalignment
- Type 4 interlocking device per ISO 14119 with low coded actuators



Small Size, High Integrity

With the increasing speed and complexity of applications, a simple magnetic switch may be insufficient to meet the increased risks. The Magnetically Coded MC1 and MC2 non-contact switches incorporate several magnetically sensitive elements, which must be triggered in a particular sequence to operate correctly. The sensor with its molded-in brackets and diminutive size, is extremely versatile and simple to install.

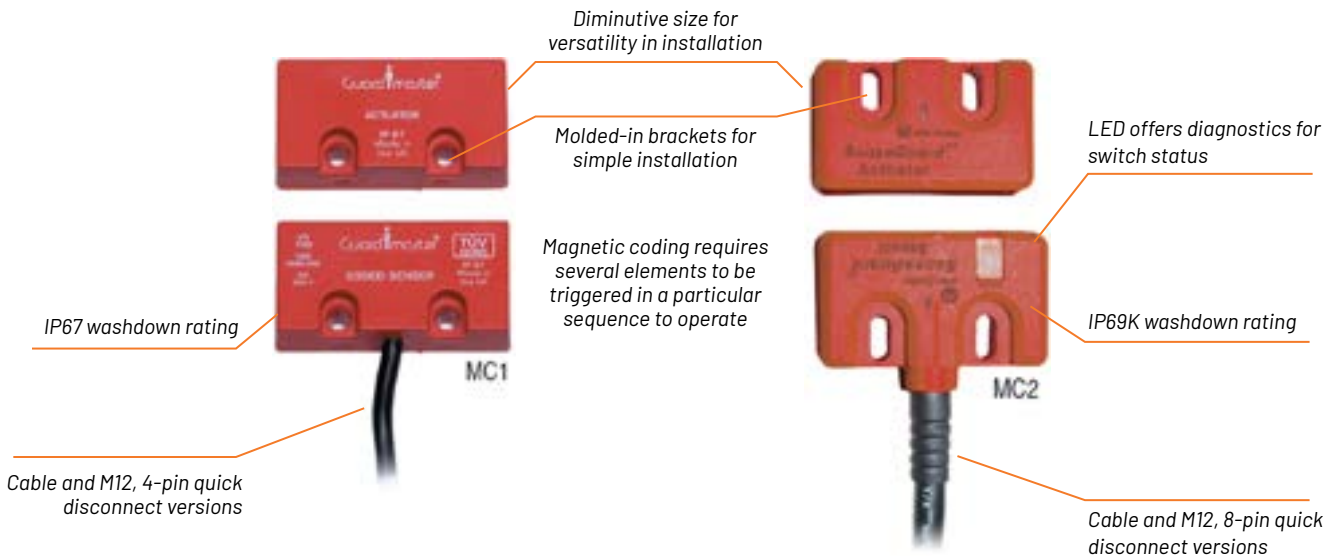

Presence Sensing Devices



5-4...5-19

Interlock Switches



5-20...5-39

Access Control



5-40...5-41

Safety Relays



5-42...5-47

Emergency Stop Devices



5-48...5-49

Safety Limit Switches



5-50...5-51

Product Selection

Magnetically Coded Non-Contact Switches

Type	Operating Voltage/ Input Current	Safety Outputs	Auxiliary Outputs	Status Indicator	Connection	Cat. No.
MC1	-	2 N.C. REEDS	-	No	4-pin micro (M12)	440N-Z2NRS1C
					3 m cable	440N-Z2NRS1A
					10 m cable	440N-Z2NRS1B
MC2	24V DC, +10%/15%/ 50 mA max.	2 N.C. Solid- State Relays	1 x PNP, 0.2 A max.; Status: OFF (OV DC)	Yes	8-pin micro (M12)	440N-Z21W1PH
					3 m cable	440N-Z21W1PA
					10 m cable	440N-Z21W1PB

Specifications

Standards	ISO 14119, IEC 60947-5-3, ISO 13849-1 when used with approved safety control
Safety Classification	Type 4 Interlocking Device with low coding per ISO 14119
Functional Safety Data	Visit https://rok.auto/safety-sr001
Certifications	CULus Listed, TÜV Certified, and CE Marked for all applicable directives https://rok.auto/certifications

Required Cordsets & Accessories

Description	Cat. No.	
Cordset	889D-F4AC ⁻¹	889D-F8AB ⁻¹
Patchcord	889D-F4ACDM ⁻²	889D-F8ABDM ⁻²
Distribution box	898D-4 ³ LT-DM4	-
Shorting plug	898D-41LU-DM	-
T-port	898D-43LY-D4	-

¹ Replace symbol with **2**, **5**, or **10** for standard cable lengths in meters.

² Replace symbol with **1**, **2**, **3**, **5**, or **10** for standard lengths in meters.

³ Replace with **4** or **8** for number of ports available.

Note: For additional information, see Safety Connection Systems (page 4-50).



Sales Offices and Distributors

Our network of sales offices and distributors offers exceptional knowledge and service to help you design, implement and support your automation investment.

<https://rok.auto/buy>



Interlock Switches





SAFETY

Tongue Interlock Switches 440K

- A full range of guard interlocking switches
- Holding forces up to 40 N
- Multiple actuator options
- Conduit or quick disconnect models
- Optional GD2 heavy duty stainless steel style heads for increased robustness
- Type 2 interlocking devices per ISO 14119 with low coded tongue-shaped actuators



A Complete Range of Guard Interlocking Solutions

	Trojan™ T15	Trojan T5 & T6 ¹	Elf™	Cadet™	MT-GD2
Description					
Dimensions [H x W x D]	75 x 31 x 52 mm (2.95 x 1.22 x 2.05 in.)	95 x 32 x 52 mm (3.74 x 1.26 x 2.05 in.)	75 x 25 x 29 mm (2.95 x 0.98 x 1.14 in.)	90.5 x 31 x 30.4 mm (3.56 x 1.22 x 1.2 in.)	116.5 x 38 x 40 mm (4.59 x 1.5 x 1.57 in.)
Break Contact Force	30 N	T5: 12 N typical, max. 30 N T6: 20 N	6 N	15 N	12, 32, 40 N
Safety/Aux. Contacts	2 N.C. 1 N.C./1 N.O.	T5: 2 N.C./1 N.O. T6: 3 N.C./1 N.O. T6: 2 N.C./2 N.O.	2 N.C. 1 N.C./1 N.O.	3 N.C. 2 N.C./1 N.O.	3 N.C./1 N.O. 2 N.C./2 N.O.
Material	Plastic w/plastic or metal head (GD2)	Plastic w/plastic or metal head (GD2)	Plastic w/optional metal alignment guide	Plastic w/optional metal alignment guide	Metal
Actuator Options	Standard & fully flexible	Standard, semi-flexible, & fully flexible	Flat, 90°, & semi-flexible	Flat, 90°, & semi-flexible	Standard, fully flexible, & extended flat

¹ Four-contact models are available (Trojan 6).

Presence Sensing Devices



5-4...5-19

Interlock Switches



5-20...5-39

Access Control



5-40...5-41

Safety Relays



5-42...5-47

Emergency Stop Devices



5-48...5-49

Safety Limit Switches



5-50...5-51



Product Selection

Trojan T15 & Trojan 5 Standard Plastic Switches

Type	Contact		Contact Action ²	Actuator Type	Cat. No.		
	Safety	Auxiliary			M20 Conduit		Connector Micro (M12) ³
					M20	1/2 in. NPT Adaptor	
Trojan T15 standard	2 N.C.	-	-	Standard	440K-T11303	440K-T11267	440K-T11307
				Fully flexible	440K-T11395	440K-T11273	440K-T11384
	1 N.C.	1 N.O.	BBM	Standard	440K-T11305	440K-T11268	440K-T11386
				Fully flexible	440K-T11396	440K-T11276	440K-T11387
Trojan T15 GD2 (metal head)	2 N.C.	-	-	GD2 Standard	440K-T11463	440K-T11288	440K-T11389
				Fully flexible	440K-T11397	440K-T11287	440K-T11390
	1 N.C.	1 N.O.	BBM	GD2 Standard	440K-T11398	440K-T11284	440K-T11392
				Fully flexible	440K-T11399	440K-T11283	440K-T11393
Trojan 5 standard	2 N.C.	1 N.O.	BBM	Standard	440K-T11090	440K-T11202	440K-T11205
				Semi-flexible	440K-T11110	440K-T11203	440K-T11206
				Fully flexible	440K-T11467	440K-T11204	440K-T11207
Trojan 5 GD2 (metal head)			BBM	GD2 standard	440K-T11336	440K-T11211	440K-T11366
				Semi-flexible	440K-T11337	440K-T11212	440K-T11367
				Fully flexible	440K-T11338	440K-T11213	440K-T11368
Trojan 5 30 N			BBM	Standard	440K-T11333	440K-T91024	440K-T11492

² Make Before Break (MBB) contact versions are also available.

³ Trojan T15 uses a 4-pin connector and Trojan 5 uses a 6-pin connector.

Specifications

Standards	ISO 14119, IEC 60947-5-1
Safety Classification	Type 2 Interlocking Device per ISO 14119
Functional Safety Data	Visit https://rok.auto/safety-sr001
Certifications	cULus Listed, TÜV Certified, and CE Marked for all applicable directives https://rok.auto/certifications
Outputs	
Thermal Current/_{I_{th}}	10 A
Switching Current @ Voltage	3 mA @ 18V DC, min.
Operating Characteristics	
Operating Radius	175 mm (6.89 in.) [60 mm (2.36 in.) with flexible actuator, min.]
Mechanical Life	1,000,000 operations

Required Cordsets & Accessories

Description	Cat. No.
GD2 standard actuator	440G-A27011
T15 standard actuator	440K-A11095
GD2 flat actuator	440K-A11112
T15 standard actuator	440K-A11238
Fully flexible actuator	440K-A27010
4-pin micro (M12) QD cordset	889D-F4AC- ⁴
4-pin micro (M12) QD patchcord	889D-F4ACDM- ⁵
6-pin micro (M12) QD cordset	889R-F6ECA- ⁴
6-pin micro (M12) QD patchcord	889R-F6ECRM- ⁵

⁴ Use **2**, **5**, or **10** for standard cable lengths in meters.

⁵ Use **1**, **2**, **3**, **5**, or **10** for standard cable lengths in meters.

Note: For additional information, see Safety Connection Systems (page 4-50).



Interlock Switches



Product Selection

Elf Miniature Plastic Switches

Contact			Actuator Type	Cat. No.		
				M16 Conduit		Connector
Safety	Auxiliary	Action		M16	1/2 in. NPT Adaptor	4-pin Micro (M12)
1 N.C.	1 N.O.	BBM	90°	440K-E33040	440K-E33030	440K-E33025
			Semi-flexible	440K-E33034	440K-E33031	440K-E33075
2 N.C.	-	-	90°	440K-E33041	440K-E33045	440K-E33024
			Semi-flexible	-	440K-E33046	440K-E33078

Cadet 3 Compact Plastic Switches

Contact			Actuator Type	Cat. No.		
				M16 Conduit		Connector
Safety	Auxiliary	Action		M16	1/2 in. NPT Adaptor	6-pin Micro (M12)
3 N.C.	-	-	90°	440K-C21097	440K-C21057	440K-C21091
			Semi-flexible	-	440K-C21062	440K-C21092
2 N.C.	1 N.O.	BBM	90°	440K-C21061	440K-C21058	440K-C21067
			Semi-flexible	-	440K-C21074	440K-C21088

Specifications

Standards	ISO 14119
Safety Classification	Type 2 Interlocking Device per ISO 14119
Functional Safety Data	Visit http://literature.rockwellautomation.com/idc/groups/literature/documents/sr/safety-sr001L-en-e.pdf
Certifications	cULus Listed, TÜV Certified, and CE Marked for all applicable directives https://rok.auto/certifications
Outputs	
Thermal Current/_{1th}	5 A (10 A if A600)
Switching Current @ Voltage	3 mA @ 18V DC, min.
Operating Characteristics	
Operating Radius	150 mm (5.90 in.) [60 mm (2.36 in.) with semi-flexible actuator, min.]
Mechanical Life	1,000,000 operations

Required Cordsets & Accessories

Description	Cat. No.
4-pin micro (M12) QD cordset	889D-F4AC ⁻¹
6-pin micro (M12) QD cordset	889R-F6ECA ⁻¹
4-pin micro (M12) QD patchcord	889D-F4ACDM ⁻²
6-pin micro (M12) QD patchcord	889R-F6ECRM ⁻²
Flat actuator ³	440K-A21014
90° actuator ³	440K-A21006
Metal alignment guide with semi-flexible actuator	440K-A21030

¹ Use **2**, **5**, or **10** for standard cable lengths in meters.

² Use **1**, **2**, **3**, **5**, or **10** for standard cable lengths in meters.

³ Not to be used with metal alignment guide.

Note: For additional information, see Safety Connection Systems (page 4-50).

Presence Sensing Devices



5-4...5-19

Interlock Switches



5-20...5-39

Access Control



5-40...5-41

Safety Relays



5-42...5-47

Emergency Stop Devices



5-48...5-49

Safety Limit Switches



5-50...5-51



Product Selection

MT-GD2 Metal Body Switches

Type	Contact		Contact Action ¹	Actuator Type	Cat. No.		
	Safety	Auxiliary			M20 Conduit		Connector
					M20	1/2 in. NPT Adaptor	12-pin (M23)
MT-GD2	3 N.C.	1 N.O.	BBM	GD2 standard	440K-MT55074	440K-MT55022	440K-MT55095
				Fully flexible	440K-MT55075	440K-MT55029	440K-MT55096
	2 N.C.	2 N.O.		GD2 standard	440K-MT55076	440K-MT55026	440K-MT55098
				Fully flexible	440K-MT55077	440K-MT55087	440K-MT55099
MT-GD2 latch release	3 N.C.	1 N.O.		GD2 standard	440K-MT55078	440K-MT55041	440K-MT55070
				Fully flexible	440K-MT55079	440K-MT55045	440K-MT55103
	2 N.C.	2 N.O.		GD2 standard	440K-MT55080	440K-MT55050	440K-MT55104
				Fully flexible	440K-MT55081	440K-MT55051	440K-MT55052

¹ Make Before Break (MBB) and snap acting contact versions are also available.

Specifications

Standards	ISO 14119, ISO 13849-1, IEC 60947-5-1
Safety Classification	Type 2 interlocking device per ISO 14119
Functional Safety Data	Visit https://rok.auto/safety-sr001
Certifications	cULus Listed, TÜV Certified, and CE Marked for all applicable directives https://rok.auto/certifications
Outputs	
Thermal Current/_{I_{th}}	10 A
Switching Current @ Voltage	3 mA @ 18V DC, min.
Operating Characteristics	
Break Contact Force	12 N (1.35 lbf), min.
Operating Radius	150 mm (5.90 in.) [60 mm (2.36 in.) with GD2 kit, min.]
Mechanical Life	1,000,000 operations

Required Cordsets & Accessories

Description	Cat. No.
12-pin (M23) QD cordset	889M-FX9AE- ²
GD2 standard actuator	440G-A27011
GD2 flat actuator	440K-ATM12
Fully flexible actuator	440K-A27010

² Use **2**, **5**, or **10** for standard cable lengths in meters.

Note: For additional information, see Safety Connection Systems (page 4-50).

Additional Safety Switches

- 440G-MT Guard Locking Solenoid Switches
- 440H Hinge Interlock Switches
- 440J Enabling Switches



Interlock Switches

SAFETY

Electromagnetic Switches 440G-EZ

- PLe Cat 4, SIL CL3 for door position monitoring
- Type 4 interlocking device with a Power to Lock (PTL) electromagnetic locking function for process protection per ISO 14119
- Solid state OSSD outputs
- High tolerance to door offset within 5 mm (0.2 in.) in all directions
- IP69K enclosure rating
- Status indicators for switch and lock status
- Sensor can be surface mounted or flush mounted

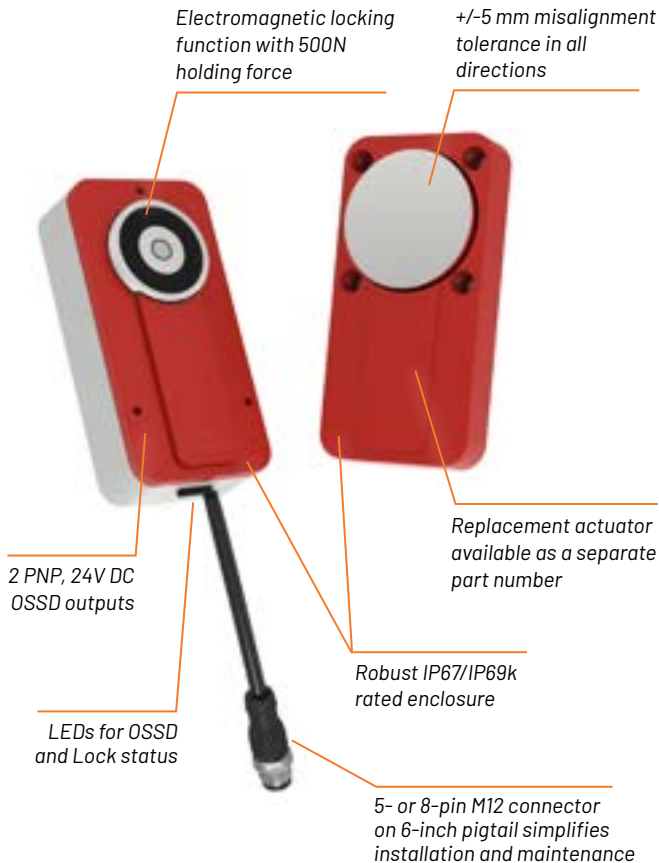

Protection for Personnel and Process

Guardmaster® safety switches help protect personnel, processes and equipment by providing physical interlocking of guard doors, allowing access to potentially hazardous areas only when the area is safe.

The 440G-EZ electromagnetic interlocking safety switch is designed to protect a working process from unplanned downtime to improve productivity and increase efficiency while providing personnel safety.

The 440G-EZ electromagnetic safety switch combines a PTL electromagnetic locking function featuring a 500N holding force and ± 5 mm misalignment tolerance. Intended for use on all types of guard doors, 440G-EZ electromagnetic safety switches are TÜV-certified up to Cat 4, SIL3, PLe – the highest level of safety for guard position monitoring – and can be connected in series with other Cat 4, SIL 3 or PLe rated safety devices.

Presence Sensing Devices



5-4...5-19

Interlock Switches



5-20...5-39

Access Control



5-40...5-41

Safety Relays



5-42...5-47

Emergency Stop Devices



5-48...5-49

Safety Limit Switches



5-50...5-51

Product Selection

440G-EZ Electromagnetic Switches

Description	Cat. No. ¹
5-pin Micro QD version (for point-to-point wiring)	440G-EZS2ISTL05J
8-pin Micro QD version (for series wiring)	440G-EZS2ISTL05H
Replacement actuator	440G-EMAS

¹ Product is supplied with safety switch, actuator, 4 screw hole caps and installation instructions.

Specifications

Standards	IEC 60947-5-3, IEC 60947-5-1, IEC 61508, EN ISO 13849-1, IEC 62061, ISO 14119, UL 508
Safety Classification	Type 4 Interlocking Device per ISO 14119 with a power to lock (PTL) electromagnetic locking function for process protection PLe Cat 4 per ISO 13849-1 and SIL CL3 per IEC 61508 and IEC 62061
Functional Safety	PFHd 1.5 x 10 ⁻⁸ (EN ISO 13849). Mission time/PTI: 20 years
Certifications	CE marked for all applicable EU directives, c-UL-us (UL 508), TÜV, C-Tick
Input Voltage	24V DC
Holding Force	500 N
Retaining force	25 N
Safety Outputs	2 x PNP, 100 mA max., Status: ON (+24V DC)
Auxiliary Outputs	0.2 A, 25 mA max., (resistive load)
Enclosure Type Rating	IP67, IP69K

Required Accessories

Description	Cat. No.
8-pin micro (M12) QD cordset	889D-F8AB ²
8-pin micro (M12) QD patchcord	889D-F8ABDM ¹
5-pin micro (M12) QD cordset	889D-F5AC ²
5-pin micro (M12) QD patchcord	889D-F5ACDM ¹
Standard Actuator	440G-EMAS

¹ (2 m), 5 (5 m), or 10 (10 m) for standard cable lengths.

² (1 m), 2 (2 m), 3 (3 m), 5 (5 m), or 10 (10 m) for standard cable lengths.



Interlock Switches

SAFETY

Guard Locking Switches 440G-LZ

- PLe Cat 4, SIL CL3 – the highest level of safety for guard position and lock monitoring
- Solid-state OSSD outputs
- RFID unique (high) or standard (low) coded actuators
- High holding force for partial body access applications
- Power-to-release and power-to-lock versions
- IP69K and hygienic design
- Type 4 interlocking device with guard locking per ISO 14119 with low or high coded RFID actuators
- Auxiliary output versions: lock status or guard proximity

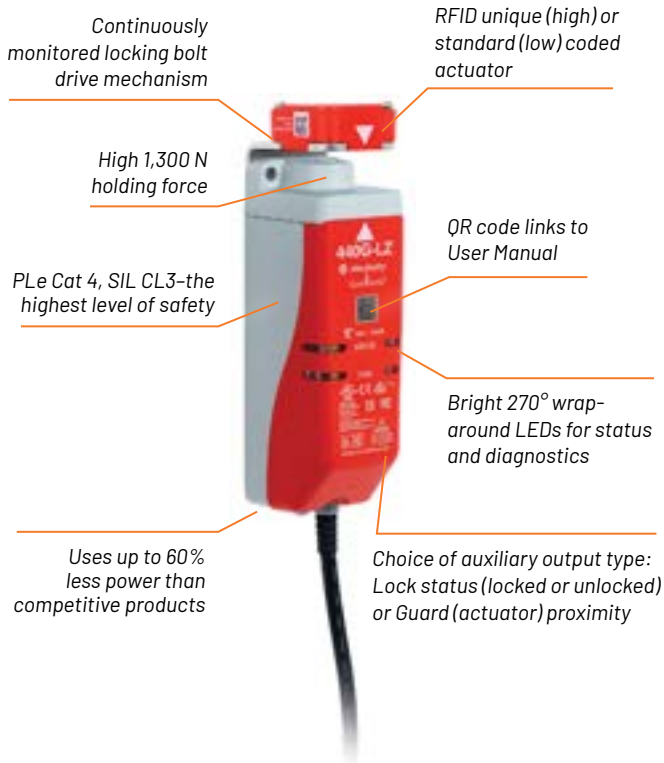

The Highest Level of Safety

The Guardmaster® 440G-LZ is a guard locking switch designed for partial body access guards. Combining microprocessor technology with an RFID coded actuator, the 440G-LZ features a locking bolt drive mechanism that will only lock when the correct actuator is detected. The locking bolt is continuously monitored for correct insertion within the actuator. This extra functionality allows the 440G-LZ to be certified PLe Cat 4, SIL CL3 – the highest level of safety for guard position and lock monitoring – and it can be connected directly or in series with other PLe Cat 4 or SIL CL3 rated safety devices.



Interlock Switches

Presence Sensing Devices



5-4...5-19



5-20...5-39

Access Control



5-40...5-41

Safety Relays



5-42...5-47

Emergency Stop Devices



5-48...5-49

Safety Limit Switches



5-50...5-51

Product Selection

440G-LZ Guard Locking Switches

Locking Type	Actuator Type	Cat. No. ¹			
		Connector Type			
		3 m Lead	10 m Lead	6-in. Pigtail with M12 5-pin QD	6-in. Pigtail with M12 8-pin QD
Power-to-release	Standard (low level to EN/ISO 14119:2013)	440G-LZS2IS⊗RA	440G-LZS2IS⊗RB	440G-LZS2ISJRJ	440G-LZS2IS⊗RH
	Unique (high level to EN/ISO 14119:2013)	440G-LZS2IU⊗RA	440G-LZS2IU⊗RB	440G-LZS2IUJRJ	440G-LZS2IU⊗RH
Power-to-lock	Standard (low level to EN/ISO 14119:2013)	440G-LZS2IS⊗LA	440G-LZS2IS⊗LB	440G-LZS2ISJLJ	440G-LZS2IS⊗LH
	Unique (high level to EN/ISO 14119:2013)	440G-LZS2IU⊗LA	440G-LZS2IU⊗LB	440G-LZS2IUJLJ	440G-LZS2IU⊗LH

¹ To select auxiliary output type, replace ⊗ in front of last two letters in catalog number with **P** for lock status or **T** for guard proximity. Example: 440G-TZS2IUTRH.

Specifications

Standards	ISO 14119, IEC 60947-5-3, ISO 13849-1, IEC 62061
Safety Classification	Type 4 Interlocking Device with Guard Locking per ISO 14119 with low (standard) and high (unique) coding per ISO 14119 PLe Cat 4 per ISO 13849-1 and SIL CL3 per IEC 62061
Functional Safety	Visit https://rok.auto/safety-sr001
Certifications	cULus Listed, TÜV Certified, and CE Marked for all applicable directives https://rok.auto/certifications
Power Supply	24V DC +10%/-15% Class 2 SELV
Holding Force Fzh (ISO 14119:2013)	1,300 N
Safety Outputs	2 x PNP, 0.2 A max., Status: ON (+24V DC)
Auxiliary Outputs	1 x PNP, 0.2 A max., Status: OFF (0V DC)
Enclosure Type Rating	NEMA 3, 4X, 12, 13, IP66, IP67, IP69K

Required Cordset & Accessories

Description	Cat. No.
8-pin micro (M12) QD cordset	889D-F8AB- ²
Standard power-to-release actuator	440G-LZASPR
Unique power-to-release actuator	440G-LZAUPR
Standard power-to-lock actuator	440G-LZASPL
Unique power-to-lock actuator	440G-LZAUPL
Actuator mounting bracket	440G-LZAM1
Switch body mounting bracket	440G-LZAM2

² Use **2**, **5**, or **10** for standard cable lengths in meters.

Note: For additional information, see Safety Connection Systems (page 4-50).



Connected Components
Simpler, faster, cost-effective machine building.
<https://rok.auto/ccw>



Interlock Switches

SAFETY

Guard Locking Switches 440G-MZ

- SIL 3, PLe, Cat 4 – the highest level of safety for guard position monitoring and guard locking
- Can operate as a standalone device (5-pin OSSD connection) or in a GuardLink system
- RFID unique (high) or standard (low) coded actuators
- High holding force optimized for full-sized guard doors, which allow whole body access to a safeguarded area
- IP65, IP66, IP67, IP69k rated



Guard Locking for Whole Body Access

440G-MZ Guard locking switches help protect personnel and are suitable for use with many types of guard doors, including full-sized guard doors, which allow whole body access to the safeguarded area, where a high holding force and a wide tolerance to guard misalignment are commonly required.

The 440G-MZ has embedded GuardLink® technology making it a smart device that provides the benefits of enunciation and product-specific diagnostics. It reduces wiring, simplifies installation and enables premier integration via an Ethernet/IP communications adapter and safety logic device when connected in a GuardLink system using a passive tap.

Switch can operate as a standalone device (OSSD mode) or in a GuardLink system (GuardLink mode)

2500 N holding force suitable for full-size guard doors

RFID actuator (unique coded or standard)

Flexible and 360° rotatable actuator facilitates +/- 5 mm misalignment tolerance and mounting flexibility

Three directions of approach for mounting flexibility

Two bright 270° wrap-around LEDs - for DEVICE and LINK status

Ingress rating: IP65, IP66, IP67, IP69k

Presence Sensing Devices



5-4...5-19

Interlock Switches



5-20...5-39

Access Control



5-40...5-41

Safety Relays



5-42...5-47

Emergency Stop Devices



5-48...5-49

Safety Limit Switches



5-50...5-51

Product Selection

440G-MZ Guard Locking Switches

Model Type	Actuator Type	Solenoid Voltage	Connection Type	Holding Force ²	Cat No. ³
Power to release	2 x PNP (0.2 mA max.), No Aux	24V DC ¹	6-in. pigtail with M12 5-pin QD	2500 N	440G-MZS20SNRJ
Power to release	2 x PNP (0.2 mA max.), No Aux	24V DC ¹	6-in. pigtail with M12 5-pin QD	2500 N	440G-MZS20UNRJ
Power to lock	2 x PNP (0.2 mA max.), No Aux	24V DC ¹	6-in. pigtail with M12 5-pin QD	2500 N	440G-MZS20SNLJ
Power to lock	2 x PNP (0.2 mA max.), No Aux	24V DC ¹	6-in. pigtail with M12 5-pin QD	2500 N	440G-MZS20UNLJ

¹ Use power supply Ue 24V DC +10% / -15% Class 2 PELV.

² Fzh as per ISO 14119.

³ For Escape Release models add "E" to end of catalog number.

Specifications

Standards	ISO 14119, IEC 60947-5-3, ISO 13849-1, IEC 62061
Safety Classification	Type 4 Interlocking Device with Guard Locking per ISO 14119 with low (standard) and high (unique) coding per ISO 14119 PLe Cat 4 per ISO 13849-1 and SIL cl3 per IEC 62061
Functional Safety	Proof test interval = 20 years; <ul style="list-style-type: none"> • OSSD mode PFHd = 3.17E-09 / PFD = 3.67E-04 <ul style="list-style-type: none"> • GuardLink[®] mode PFHd = 2.93E-09 / PFD = 3.59E-04
Certifications	cULus Listed, TÜV Certified, and CE Marked for all applicable directives https://rok.auto/certifications
Power Supply	24V DC +10%/-15% Class 2 PELV
Holding Force Fzh (ISO 14119)	2500 N
Safety Outputs	2 x PNP, 0.2 A max., Status: ON (+24V DC)
Enclosure Type Rating	IP65, IP66, IP67, IP69, IP69K

Required Cordset

Description	Cat. No.
5-pin micro (M12) QD cordset	889D-F5AC- ⁴

⁴ Use **2**, **5**, or **10** for standard cable lengths in meters.

Note: For additional information, see Safety Connection Systems (page 4-50).

Accessories

Model Type	Cat. No.	
Actuator mounting bracket	L-shaped	440G-MZAM1
	Z-shaped	440G-MZAM2
Switch mounting bracket	440G-MZAM3	
Padlock accessory	440G-MZAL	
Auxiliary Release Tool	440G-MZAT	
Replacement Screw	440G-MZRSC	
Replacement Button	440G-MZRBU	



Interlock Switches

SAFETY

TLS-Z GD2 Guard Locking Switches 440G

- Type 4 Interlocking Devices with guard locking
- Meets PLe, Cat 4 per ISO 13849-1, the highest level of safety
- RFID high level coded actuator
- Solid-state series connectable OSSD outputs
- High holding force (Fzh)
- Power-to-release and power-to-lock versions
- Auxiliary output versions: lock status or guard proximity

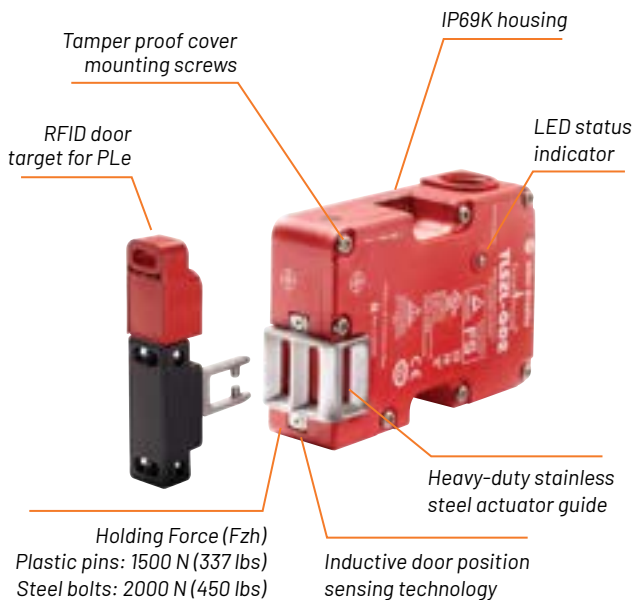

Guard Locking Plus RFID Technology for Whole Body Access

The TLS-Z GD2 Guard Locking Switch is an interlock switch that has a uniquely coded RFID technology with inductive door position sensing technology. This switch can detect if an actuator key breaks or becomes separated from its door mounted position. Built with the same solid-state technology as the SensaGuard, this switch supports the highest level of safety – Performance Level “e”, Cat 4 per ISO 13849-1 for the guard position and lock monitoring.



Presence Sensing Devices



5-4...5-19

Interlock Switches



5-20...5-39

Access Control



5-40...5-41

Safety Relays



5-42...5-47

Emergency Stop Devices



5-48...5-49

Safety Limit Switches



5-50...5-51

Product Selection

TLS-Z GD2 Guard Locking Switches

Type	Outputs		Voltage	Connector	Cat. No. ¹
	Safety (OSSD)	Auxiliary			
Power-to-release	2 x PNP, 0.2 A max., Status: ON (+24V DC)	1 x PNP, 0.2 A max., Status: OFF (0V DC)	24V DC	8-pin micro (M12)	440G-TZS2IU⊗RH
Power-to-lock					440G-TZS2IU⊗LH

¹ To select auxiliary output type, replace ⊗ in front of last two letters in catalog number with **P** for lock status or **T** for guard proximity. Example: 440G-TZS2IU**TR**H.

Specifications

Standards	ISO 14119, IEC 60947-5-3, ISO 13849-1
Safety Classification	Type 4 Interlocking Device with Guard Locking per ISO 14119 with high (unique) coding per ISO 14119 PLe Cat 4 per ISO 13849-1
Functional Safety	Visit https://rok.auto/safety-sr001
Certifications	cULus Listed, TÜV Certified, and CE Marked for all applicable directives https://rok.auto/certifications
Power Supply	24V DC +10%/-15% Class 2
Holding Force Fzh (ISO 14119)	Plastic pins: 1500 N (337 lbs) Steel bolts: 2000 N (450 lbs)
Safety Outputs	2 x PNP, 0.2 A max., Status: ON (+24V DC)
Auxiliary Outputs	1 x PNP, 0.2 A max., Status: OFF (0V DC)
Enclosure Type Rating	NEMA 3, 4X, 12, 13, IP66, IP67, IP69K

Required Cordset & Accessories

Description	Cat. No.
8-pin micro (M12) QD cordset	889D-F8AB- ¹
Spare RFID door target	440G-ATZA
Fully flexible actuator	440G-A27143
Cover for TLS-1 with external override key	440G-A27371
Cover for TLS-1 with override key attached	440G-A27373
Emergency override key	440G-A36026
Flexible release - 1 m (3.28 ft) cable	440G-A27356
Flexible release - 3 m (9.84 ft) cable	440G-A27357
Dust cover	440K-A17183

¹ Use **2**, **5**, or **10** for standard cable lengths in meters.

Note: For additional information, see Safety Connection Systems (page 4-50).



Interlock Switches

SAFETY

TLS-GD2 Guard Locking Switches 440G

- Type 2 Interlocking Devices with guard locking and low coded (tongue-shaped) actuators per ISO 14119
- Plastic enclosure with stainless steel actuator guide
- High holding force (Fzh)
- Power-to-release and power-to-lock versions
- Four actuator entry points
- Escape release versions
- Quick disconnect versions
- Large range of accessories

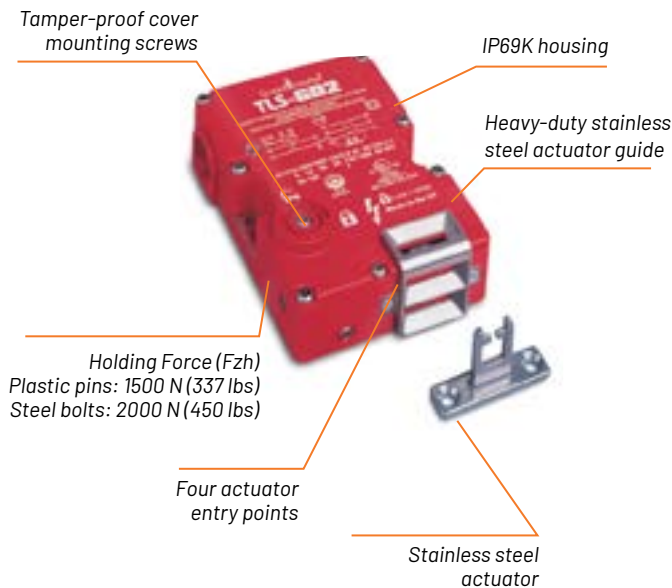

For Demanding Whole Body Access Applications

The TLS-GD2 is for demanding whole body access guard locking applications where “zero volt” connectivity is needed. A stainless steel actuator guide is fitted to protect the unit from actuator damage due to poor guard alignment or guard wear. The TLS-GD2 is available in two versions: TLS-3 GD2 is power-to-release while the TLS-2 is power-to-lock. Each product has five sets of contacts of various forms. Four actuator entry points are possible; two manual release points. Optional key release and escape release versions are available. An ingress rating of IP69K makes TLS-GD2 suitable for washdown applications.

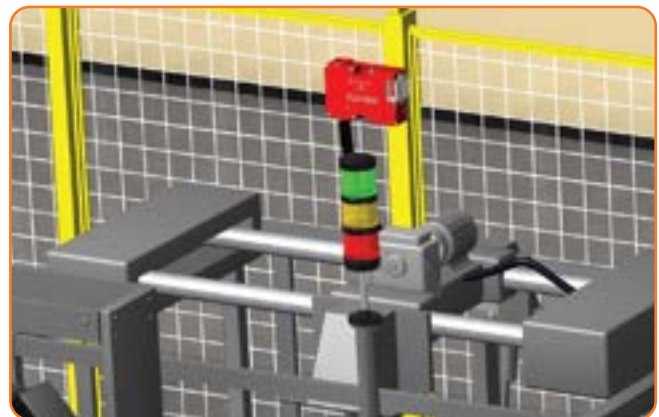

5-36

Presence Sensing Devices



5-4...5-19

Interlock Switches



5-20...5-39

Access Control



5-40...5-41

Safety Relays



5-42...5-47

Emergency Stop Devices



5-48...5-49

Safety Limit Switches



5-50...5-51

Product Selection

TLS-GD2 Guard Locking Switches

Type	Contacts		Solenoid		Actuator Type	Cat. No.			
						Conduit		Connector	
	Safety	Auxiliary	Contacts	Voltage		M20	1/2 in. NPT Adaptor	12-pin M23	8-pin Micro (M12) ¹
TLS-1 GD2 power-to-release	2 N.C.	1 N.O.	1 N.C. & 1 N.O.	24V AC/DC	-	440G-T27121	-	440G-T27233	440G-T2NBBPH-1R
					GD2 Standard	440G-T27251	440G-T27169	440G-T27234	-
					Fully Flex	440G-T27252	440G-T27171	440G-T27235	-
TLS-2 GD2 power-to-lock	2 N.C.	1 N.O.	1 N.C. & 1 N.O.	24V AC/DC	-	440G-T27127	-	440G-T27239	440G-T2NBBPH-1L
					GD2 standard	440G-T27255	440G-T27175	440G-T27240	-
					Fully flex	440G-T27256	440G-T27177	440G-T27241	-
TLS-3 GD2 power-to-release	2 N.C.	1 N.O.	2 N.C.	24V AC/DC	-	440G-T27134	-	440G-T27245	440G-T2NBBPH-2R
					GD2 standard	440G-T27259	440G-T27181	440G-T27246	-
					Fully flex	440G-T27260	440G-T27183	440G-T27247	-
TLS-3 GD2 power-to-release with escape release	2 N.C.	1 N.O.	2 N.C.	24V AC/DC	-	440G-T21BNPM-2B	440G-T21BNPT-2B	440G-T21BNPL-2B	440G-T2NBNPH-2B
					GD2 standard	440G-T21BGPM-2B	440G-T21BGPT-2B	440G-T21BGPL-2B	-

¹ With an 8-pin micro connector, not all contacts are connected.

Specifications

Standards	ISO 14119, IEC 60947-5-1
Safety Classification	Type 2 Interlocking Device with Guard Locking and low coding (tongue) per ISO 14119
Functional Safety Data	Visit https://rok.auto/safety-sr001
Certifications	cULus Listed, TÜV Certified, and CE Marked for all applicable directives https://rok.auto/certifications
Outputs	
Thermal Current/_{1th}	10 A
Switching Current @ Voltage	3 mA @ 18V DC
Operating Characteristics	
Break Contact Force	20 N (4.5 lbf), min.
Operating Radius	160 mm (6.3 in.) [80 mm (3.15 in.) with flexible actuator], min.
Mechanical Life	1,000,000 operations

Required Cordsets & Accessories

Description	Cat. No.
8-pin micro (M12) QD cordset	889D-F8AB- ²
12-pin M23 QD cordset	889M-F12AH- ²
8-pin micro (M12) QD patchcord	889D-F8ABDM- ³
12-pin M23 QD patchcord	889M-F12AHMU- ⁴
GD2 standard actuator	440G-A27011
Fully flexible actuator	440G-A27143
Cover for TLS-3 external override key	440G-A27372
Cover for TLS-3 with override key attached	440G-A27374
Flexible release-1 m (3.28 ft) cable	440G-A27356
Flexible release-3 m (9.84 ft) cable	440G-A27357
Sliding bolt actuator	440K-AMDS
Mounting plates	440K-AMDSSMPB

² Use **2**, **5**, or **10** for standard cable lengths in meters.

³ Use **1**, **2**, **3**, **5**, or **10** for standard cable lengths in meters.

⁴ Use **OM3**, **OM6**, **1**, **2**, or **3** for standard cable lengths in meters.

Note: For additional information, see Safety Connection Systems (page 4-50).

For more information on our complete family of interlock switch products, please visit:
<https://rok.auto/safety-products>



Interlock Switches

SAFETY

Trapped Key Switches 440T

- Interlocking for pre-determined sequence of events
- All stainless interlocking and coded parts
- Weather cap as standard
- Standard red color-coded key and ID tags
- A complete range of isolators, gate (guard) interlocks, key exchange units and specialty devices
- Meets the requirements of ISO 14119
- PLd, Cat 3 per ISO 13849



Trapped Key Interlocks – Why Use Them?

Based upon the premise that a key cannot be in two places at once, trapped key interlock systems can be configured to provide that a predetermined sequence of events takes place or that hazards have been reduced before operators can become exposed to them.

A trapped key interlock system is mechanical and is therefore widely used in applications including those where the location of plant, environment, or explosive atmospheres make the use of electrical interlock systems unsuitable or expensive to install. In addition, unique coding can be provided, leading to a greater degree of security and tamper-resistance.

In order to derive the full benefits from a trapped key interlocking system its components must be totally practical, easily maintainable, and readily available. The unique key and code barrel of Prosafe® gives the ability for even complicated interlocking systems and spare parts to be ordered from our worldwide network of distributors fast – which is a first for trapped key interlocks.

Isolators



Designed to isolate the machine's power and ensure the power remains off while the key is being used in another part of the interlocking system.

Exchange Units



Used in an interlocking sequence to link other devices.

Interlocks



Ideal for interlocking guard doors, cams and valves.

To see our complete Prosafe solution (from access and chain switches to miniature valve switches, switchgear adaptors and more): Go to <https://rok.auto/safety-products>

Presence Sensing Devices



5-4...5-19

Interlock Switches



5-20...5-39

Access Control



5-40...5-41

Safety Relays



5-42...5-47

Emergency Stop Devices



5-48...5-49

Safety Limit Switches



5-50...5-51

Design Suggestions for an Interlocking System

Plant and Machinery Interlocking

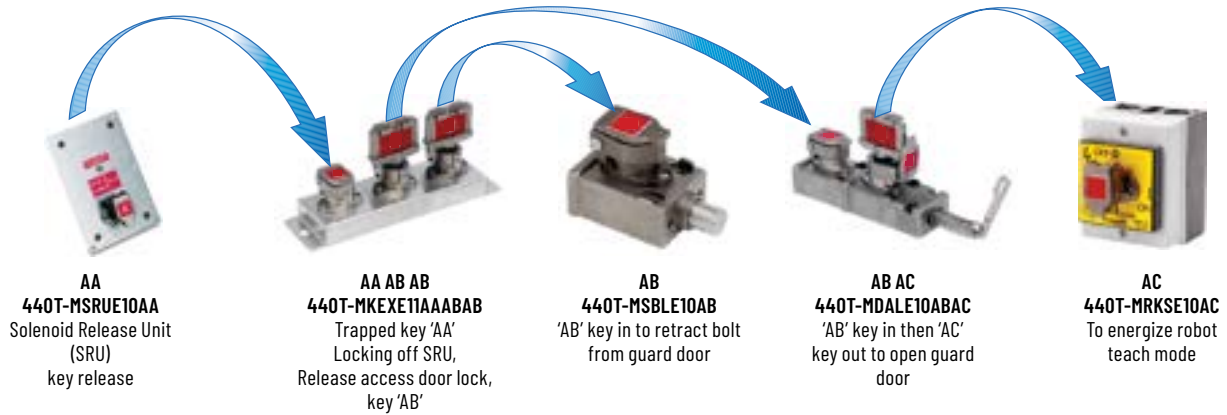

Sequence of Operation

The Solenoid Release Unit (SRU) is used for electrical isolation of machinery to improve safe access. It consists of a rotary power switch and a solenoid. The trapped key can be removed once an external signal is given to its internal solenoid locking mechanism. An indicator light on the solenoid release unit indicates when the trapped key "AA" key can be removed. Insert the "AA" key into the Key Exchange Unit (KEX) and turn it 90°.

- Turn one of the "AB" keys 90° and remove it from the KEX. This traps the "AA" key in the KEX and prevents the restarting of the machine.
- Insert the "AB" key into the Single-key Bolt Lock (SBL) and turn it 90° to gain partial body access to the machine.

- Turn the second "AB" key 90° and remove it from the KEX. Removal of this key also traps the "AA" key in the KEX and prevents the restarting of the machine.
- Insert the "AB" key into the Dual-key Access Lock (DAL) and turn it 90°.
- Turn the "AC" key 90° and remove the "AC" key. Rotate the access handle to allow full body entry into the hazard zone.
- Take the "AC" key into the hazard zone, insert it into the rotary key switch (RKSE) and turn it 90° to send a signal to the machine control system, to allow the machine to operate in a slow or teach mode.

Reverse the process to return the machine to full operational mode.

Specifications

Standards	ISO 14119, DGUV GS-ET-31, ISO 13849
Safety Classification	Meets the requirements of ISO 14119 PLd, Category 3 per ISO 13849
Functional Safety	Visit https://rok.auto/safety-sr001
Certifications	cULus Listed, TÜV Certified, and CE Marked for all applicable directives https://rok.auto/certifications

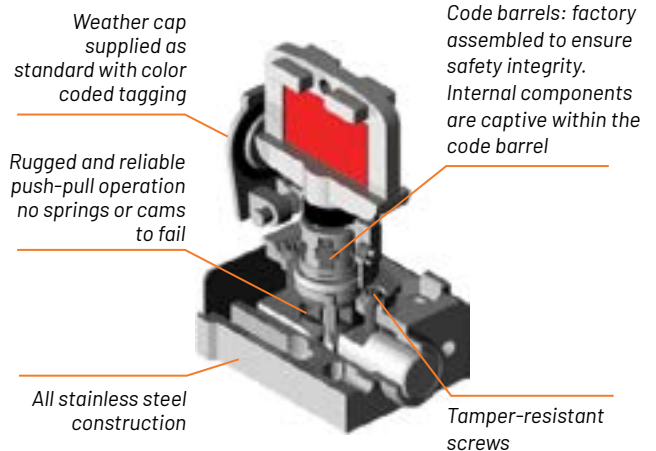

Access Control

SAFETY

Multifunctional Access Box 442G

- High holding force (Fzh) 2000 N per ISO 14119
- Power-to-Release or Power-to-Lock modules
- Diagnostic outputs for door position, bolt position, and lock status are available to the control system
- Standard models can be operated as a standalone device or in series with other devices, maintaining a PLe Cat 4 safety rating to ISO 13849-1
- Ethernet models enable easy integration in a networked automation control system using Studio 5000 Logix Designer



The Guardmaster® 442G Multifunctional Access Box, is an integrated access control and guard locking device which provides a complete safeguarding solution for full body access applications.

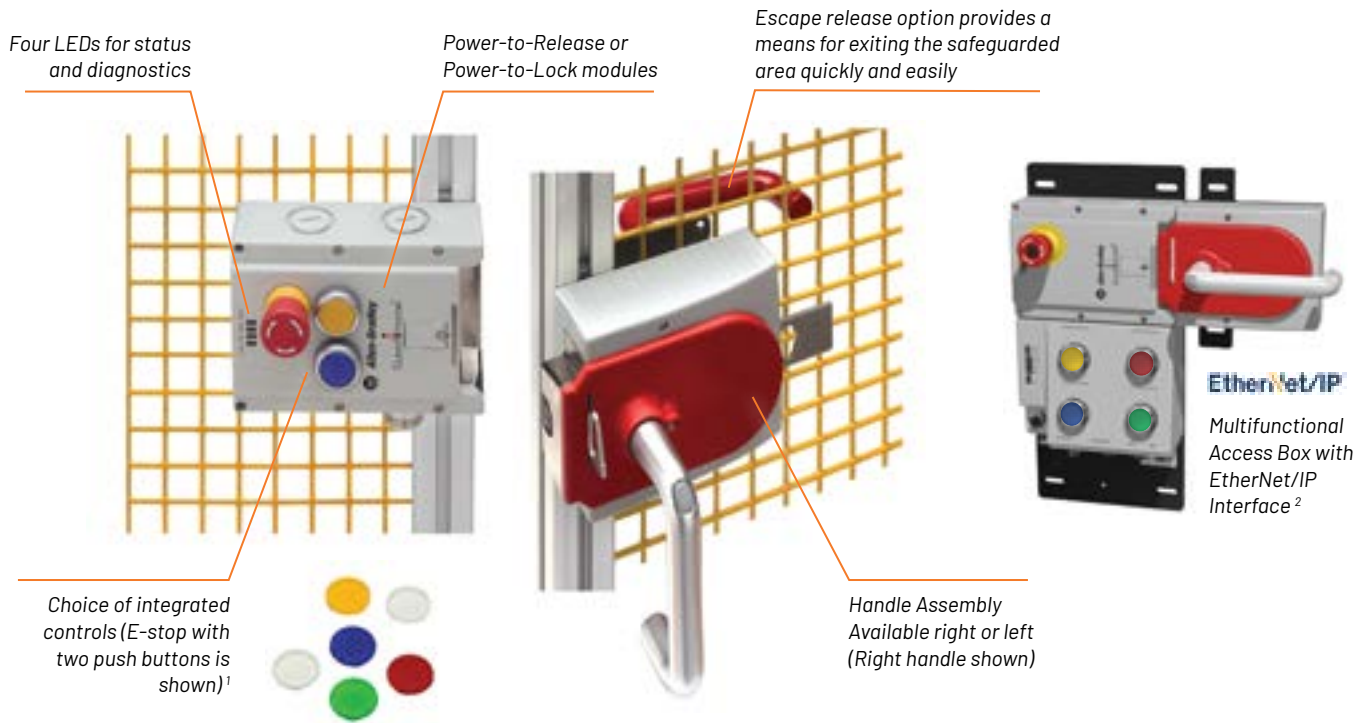

¹ Units with push buttons are supplied with a kit of colored caps, including one each of blue, green, red and yellow, and two white.
² Shown with required mounting plate.

Access Control

Presence Sensing Devices



5-4...5-19

Interlock Switches



5-20...5-39



5-40...5-41

Safety Relays



5-42...5-47

Emergency Stop Devices



5-48...5-49

Safety Limit Switches



5-50...5-51

Product Selection

Step 1: Select Handle Assembly

Description		Cat. No.
Right handle		442G-MABH-R
Left handle		442G-MABH-L
Handle assembly mounting plate ¹		442G-MABAMPH

¹ Handle assembly mounting plate is required for Ethernet versions, optional for standard.

Step 2: Lock Module (Standard or Ethernet)

Standard Lock Module		
Lock Type	Connector	Catalog Number
Power-to-release	M23 (19-pin)	442G-MABR-U⊗M-◆
	M20 cable entry	442G-MABR-UT-◆
Power-to-lock	M23 (19-pin)	442G-MABL-U⊗M-◆
	M20 cable entry	442G-MABL-UT-◆
Ethernet Lock Module		
Lock Type	Description	Catalog Number
Power-to-release	Two push buttons ²	442G-MABRB-U⊗-P49
Power-to-lock		442G-MABLB-U⊗-P49
Power-to-release	E-stop, two push buttons ²	442G-MABRB-U⊗-EOP49
Power-to-lock		442G-MABLB-U⊗-EOP49
Power-to-release	E-stop, four push buttons, enabling switch connector ²	442G-MABRB-U⊗-E0JP4679 ³
Power-to-lock		442G-MABLB-U⊗-E0JP4679 ³

² Covers with push buttons are supplied with a colored lens kit, including one each of blue, green, red and yellow, and two white.

³ Ethernet models come standard with two 4-pin (M12) power connectors. They are also available with two 4-pin 7/8" mini-style power connectors (add -N4 suffix to catalog number).

⊗ Replace ⊗ with **R** for use with right handle or **L** for use with left handle.





◆ Replace the ◆ with the code for the selected cover controls.

Example: 442G-MABR-UT-**C01**

Specifications

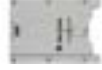
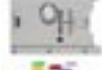
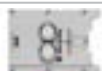
Standards	ISO 14119, IEC 60947-5-3, ISO 13849-1 EStop: ISO 13850, IEC 60947-5-1, IEC 60947-5-5
Safety Classification of Interlocking Device Functions	Type 4 Interlocking Device with Guard Locking with high (unique) coding per ISO 14119 PLe Cat 4 per ISO 13849-1
Functional Safety	Visit https://rok.auto/safety-sr001
Certifications	cULus Listed, TUV Certified, and CE Marked for all applicable directives https://rok.auto/certifications
Power Supply	Class 2 PELV 24V DC +10/-15% required
Holding Force Fzh (ISO 14119)	2000 N (450 lbs)
Safety Outputs	Standard versions: 2 x PNP, 0.2 A max., Status: ON (+24V DC); Ethernet versions: CIP Safety
Enclosure Type Rating	IP65

Cover Controls

Description		Cat. No.
Blank cover		C00
One illuminated push button ²		C01
Two illuminated push buttons ²		C02
E-stop with two illuminated push buttons ²		C03
E-stop with three illuminated push buttons ²		C04
E-stop only		C05

² Covers with push buttons are supplied with a colored lens kit, including one each of blue, green, red and yellow, and two white.

Note: If you selected right handle assembly and want a power-to-release lock module with a (19-pin) M23 connector and two illuminated push buttons, you would order 442G-MABR-URM-C02.

Accessories

Description	Cat. No.
Escape release assembly w/standard actuation shaft (115 mm)	442G-MABE1
Escape release mounting plate	442G-MABAMPE
Escape release shaft (250 mm)	442G-MABASHFT
Lock module mounting plate	442G-MABAMPL
19-pin M23 2 m cordset ⁴	889M-F19RM-2

⁴ For additional cordset lengths, please visit <https://rok.auto/directory>



Safety Relays

SAFETY

Software-Configurable Relay 440C

- Monitoring and Configuration from Studio 5000 Logix Designer® or Connected Components Workbench software
- PLe Cat 4 per EN ISO 13849-1 & SIL CL3 per IEC 62061
- Predefined function blocks
- AND, OR, NAND, NOR, XOR Logic functions
- 22-point embedded safety I/O
- Expandable via two Micro800® Plug-in I/O Modules
- Expandable with EtherNet/IP™ plug-in
- Embedded communication via USB programming port and non-isolated RS-232 serial port
- Two single-wire safety input/output points

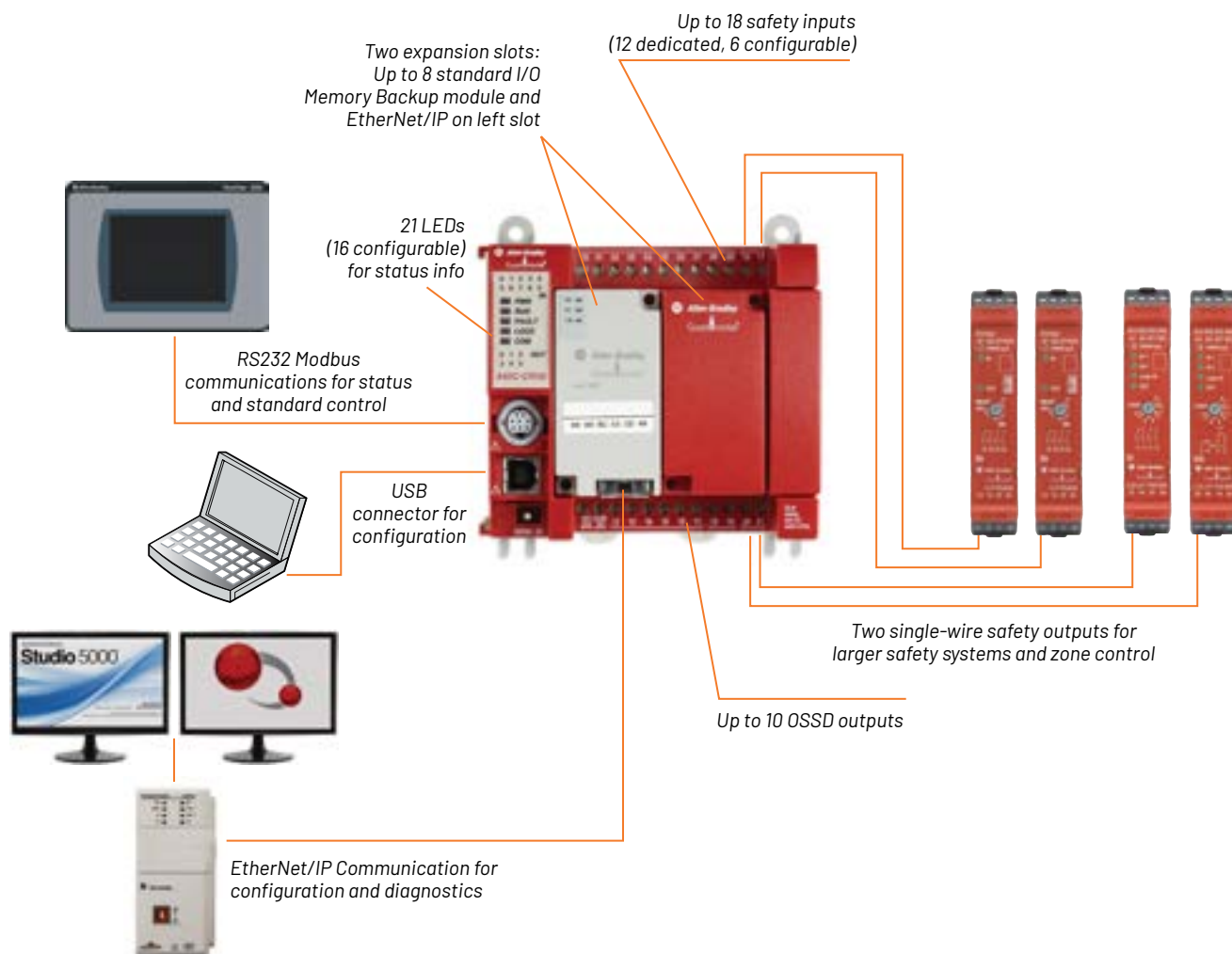

Presence Sensing Devices



5-4...5-19

Interlock Switches



5-20...5-39

Access Control



5-40...5-41

Safety Relays



5-42...5-47

Emergency Stop Devices



5-48...5-49

Safety Limit Switches



5-50...5-51

Product Selection

Software Configurable Relay

Relay Type	No. of Inputs	Type of Inputs	No. of Outputs	Cat No.
Software Configurable	Up to 18	1 N.C., 2 N.C., 3 N.C., 10 SSD, 20 SSD, 30 SSD, Mat, 2-hand control	Up to 10	440C-CR30-22BBB

Configuration with Connected Components Workbench

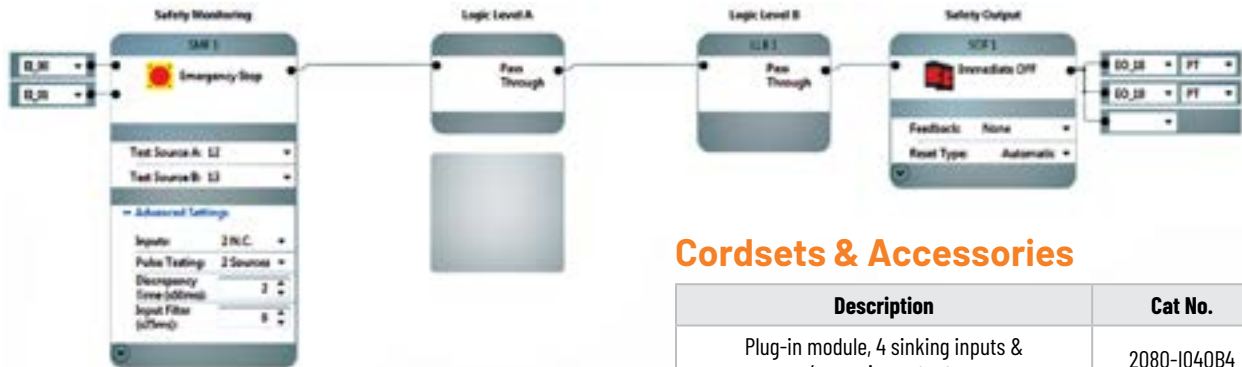

Specifications

Safety Rating	Up to SIL CL3 Cat 4 per IEC 61508 and PLe per ISO 13849-1
Number of I/O	22 (plus 16 additional on plug-in modules)
Operating Temperature [C (F)]	-5...+55 ° (23...131 °)
Operating Voltage	20.4...26.4V DC UL Class 1, Div 2, PELV/SELV
Power Consumption	5.28 W
Output Current	0.5 A continuous, 1 A surge per point
Response Times	Safety inputs <45 ms Safety mats < 70 ms Single-wire safety output <60 ms
Dimensions	90 x 100 x 80 mm (3.54 x 3.94 x 3.15 in.)



Looking for More?

This catalog highlights only our most essential components; for a complete product selection, visit us at: <https://rok.auto/directory>

Cordsets & Accessories

Description	Cat No.
Plug-in module, 4 sinking inputs & 4 sourcing outputs	2080-IQ40B4
Power supply, 120/240V AC	2080-PS120-240VAC
4-pt digital input, 12/24V DC, sink/source, IEC3	2080-IQ4
4-pt digital output, 12/24V DC, source	2080-OB4
4-pt relay output, individually isolated, 2 A	2080-OW4I
Memory backup and restore plug-in module	2080-MEMBAK-RTC
EtherNet/IP plug-in module	440C-ENET
Communication Cables	
8-pin mini DIN to 8-pin mini DIN 0.5 m (1.5 ft)	1761-CBL-AM00
8-pin mini DIN to 8-pin mini DIN 2 m (6.5 ft) cable	1761-CBL-HM02
8-pin mini DIN to 9-pin D shell 0.5 m (1.5 ft) cable	1761-CBL-AP00
8-pin mini DIN to 9-pin D shell 2 m (6.5 ft) cable	1761-CBL-PM02
Straight male RJ45 to straight male RJ45 ethernet patchcord, 8-conductor (4 pair), Cat 5e, TPE, 2m length	1585J-M8TBJM-2
Right angle male RJ45 to straight male RJ45 ethernet patchcord, 8-conductor (4 pair), Cat 5e, TPE, 2m length	1585J-M8TBJM-2
Left angle male RJ45 to straight male RJ45 ethernet patchcord, 8-conductor (4 pair), Cat 5e, TPE, 2m length	1585J-M8TBJM-2



Safety Relays

SAFETY

Guardmaster® Safety Relays (GSR Family) 440R

- A broad range of safety functions
- Simple logic, reset, and timing configurations
- Single-wire safety relay connection
- Universal inputs
- Compact 22.5 mm housings
- Optional EtherNet/IP network interface



Guardmaster Safety Relays

Guardmaster Safety Relays include units capable of monitoring a broad range of safety devices in a variety of applications. These units can achieve most of the functions safety systems require, helping simplify purchasing and parts management. The family is designed to meet new functional safety standards, such as EN ISO 13849-1 or IEC/EN 62061 and offers key functions to simply installations and system complexity.

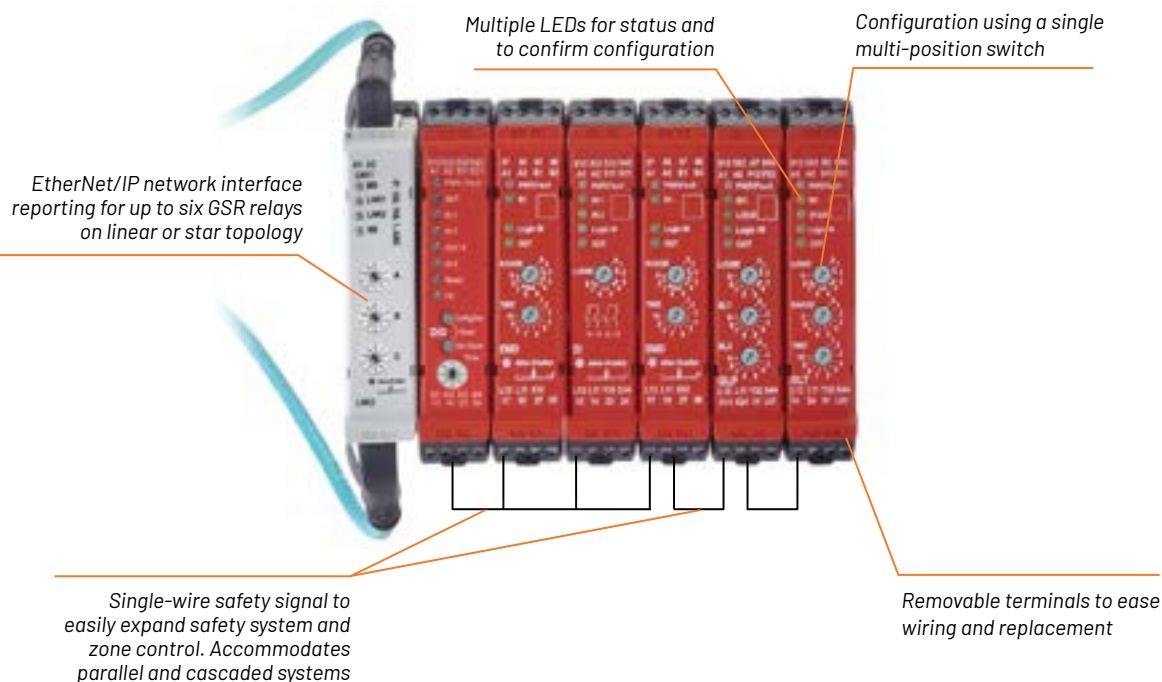

5-44

Presence Sensing Devices



5-4...5-19

Interlock Switches



5-20...5-39

Access Control



5-40...5-41

Safety Relays



5-42...5-47

Emergency Stop Devices



5-48...5-49

Safety Limit Switches



5-50...5-51

Product Selection

Guardmaster® Safety Relays

Relay Type	No. of Inputs	Inputs	Immediate Safety Outputs	Delayed Safety Outputs	Time Delay	Immediate Auxiliary Outputs	Power Supply	Cat No.
Dual GuardLink (DG)	2 dual-channel and 1 SWS	1 N.C., 2 N.C., OSSD, GuardLink	SWS	2 N.O.	0 ms...30 s	up to 1 S.S.	24V DC	440R-DG2R2T
Dual Input (DI)		1 N.C., 2 N.C., OSSD, safety mat	2 N.O.	-	-	1 S.S.		440R-D22R2
Dual Input Solid-State Output (DIS)			2 S.S.					440R-D22S2
Single Input (SI)	1 dual-channel	1 N.C., 2 N.C., OSSD, safety mat	2 N.O.	-	-	1 S.S.	24V DC	440R-S12R2
Compatible Input (CI)		-	3 N.O.					440R-S13R2
Guard Locking Proximity (GLP)	1 dual channel, 2 PNP and 1 SWS	2 N.C., OSSD	2 S.S.	-	-	1 S.S.	24V DC	440R-GL2S2P
Guard Locking with Time Delay (GLT)	1 dual-channel and 1 SWS	2 N.C. or OSSD	2 S.S.	2 S.S.	100 ms...30 min	1 S.S.	24V DC	440R-GL2S2T
Expansion Module (EM)	1 single-wire safety	-	4 N.O.	-	-	1 S.S.	24V DC	440R-EM4R2
Expansion Module Time Delayed (EMD)			DI/SI: 2 N.O. CI: 3 N.O. DIS: 2 PNP (14, 24); 2 decoupled (34, 44) EM: 4 N.O. EMD: 4 N.O. delayed DIS/GLP: 2 PNP safety, 2 PNP lock	4 N.O.	100 ms...300 s on or off delay 100 ms...20 s jog			440R-EM4R2D
Ethernet Module							24V DC	440R-ENETR

Specifications

Standards	IEC 60204-1, ISO 13849-1, IEC 61508
Safety Classification	DI/DIS/CI/SI/EM/EMD/GLT: Suitable up to PLe and Cat 4 per ISO 13849-1, SIL CL3 per IEC 61508/IEC 62061:2006 depending on architecture and application characteristics GLP: Suitable up to PLd and Cat 3 per ISO 13849-1, SIL cl2 per IEC 61508:2010/IEC 62061 depending on architecture and application characteristics
Certifications	cULus Listed, TÜV Certified, China RoHs, CCCs, SMark and CE Marked for all applicable directives
Enclosure Type Rating/ Terminal Protection	IP40 (NEMA 1)/IP20
Operating Temperature [C (F)]	-5...+55 ° (23...131 °)
Mounting	35 mm DIN Rail
Conductor Size, Max.	0.2...4 mm ² (24...12 AWG)

Required Cordsets & Accessories

Description	Cat No.
Straight male RJ45 to straight male RJ45 ethernet patchcord, 8-conductor (4 pair), Cat 5e, TPE, 2 m length ¹	1585J-M8TBJM-2
Right angle male RJ45 to straight male RJ45 ethernet patchcord, 8-conductor (4 pair), Cat 5e, TPE, 2 m length ²	1585J-E8TBJM-2
Left angle male RJ45 to straight male RJ45 ethernet patchcord, 8-conductor (4 pair), Cat 5e, TPE, 2 m length ³	1585J-L8TBJM-2
GSR Replacement Screw Terminal kit, 4 pcs	440R-ATP4
GSR Replacement Spring Clamp Terminal kit, 4 pcs	440R-ATSC4

¹ All Ethernet media cables are available in 0.1 m increments up to 80 m.

² Recommended for RJ45 connection located at the top of the Guardmaster EtherNet/IP network interface.

³ Recommended for RJ45 connection located at the bottom of the Guardmaster EtherNet/IP network interface.



Safety Relays

SAFETY

Single and Specialty Function Safety Relays (MSR Family) 440R

- Single function and specialty relays
- Broad range of input types
- Multiple output configurations
- Electromechanical or solid-state
- Compact housings
- Fixed or removable terminals
- Safe speed control (MSR57)
- Back EMF Monitor (MSR55)



A Full Line of Single and Specialty Function Relays

Guardmaster® single function and specialty safety relays support a wide variety of input devices and output configurations. Ideal for relatively small safety applications and single zone control, these relays are compact packages with removable terminals. They are also available in electromechanical versions, or solid-state models for applications involving high cycle rates. Applications include safe speed control (MSR57), Back EMF monitor (MSR55) and safety control circuits involving light curtains, laser scanners, safety mats, interlock switches, guard locking interlocks, two-hand controls, safety edges, enabling devices, and E-stop push buttons.



Interface directly and monitor safety control relays, valves, contactors, drives, and motion systems.

The MSR57 is ideal for small- to medium-sized safety related control systems dedicated to specific applications.

Presence Sensing Devices



5-4...5-19

Interlock Switches



5-20...5-39

Access Control



5-40...5-41

Safety Relays



5-42...5-47

Emergency Stop Devices



5-48...5-49

Safety Limit Switches



5-50...5-51

Product Selection

Single and Specialty Function Safety Relays

Model	Safety Inputs	Safety Inputs		Safety Outputs		Current ¹ @ 24V DC	Delay Time	Terminals	Reset	Power	Cat No.	
		Immed.	Delayed	Immed.	Delayed							
MSR126	1 N.C., light curtain	2 N.O.	-	-	-	6 A	-	Removable	Auto./man.	24V AC/DC	440R-N23117	
MSR126.1	2 N.C.							Fixed	Mon. man.		440R-N23123	
MSR127	1 N.C., 2 N.C., light curtain	3 N.O.	-	1 N.C.	-	5 A	-	Removable	Auto./man.	24V AC/DC	440R-N23132	
								Spring			440R-N23132S	
								Fixed			440R-N23126	
								Removable	Mon. man.	115V DC	440R-N23131	
								Fixed		24V AC/DC	440R-N23135	
								Fixed		24V AC/DC	440R-N23129	
MSR132 (expansion)	1 N.C., 2 N.C.	4 N.O.	-	2 N.C.	-	3 A	-	Removable	Automatic	24V AC/DC	440R-E23097	
							Fixed	440R-E23191				
MSR138	1 N.C., 2 N.C. light curtain	2 N.O.	3 N.O.	-	-	6 A	0.15...3 s 0.5...10 s 1.5...30 s 0.15...3 s 0.5...10 s 1.5...30 s	Removable	Auto./mon. man.	24V AC/DC	440R-M23143	
MSR138.1			2 N.O.								1 N.C.	440R-M23147
												440R-M23151
												440R-M23084
												440R-M23088
												440R-M23092
MSR57 Speed Monitoring	5 x 1 N.C., 2 N.C., light curtain 1 N.O. & 1 N.C.	6 N.O.	-	4 N.O.	-	-	-	Removable	Automatic/ monitored manual	24V DC	440R-S845AER-NNL	
MSR125 Two-Hand Control	1 N.C. & 1 N.O.	2 N.O.	-	-	-	-	-		Auto./man.	24V AC/DC	440R-D23171	
MSR 55P	2 Redundant					4 A				24V DC	440R-S35011	
BACK EMF Monitor	monitored channels	-	-	-	1 N.C.	0.2...6 s	Removable	Auto./man.		115V AC	440R-S35012	
										230V AC	440R-S35013	
											440R-S35016	

¹ DC-13 inductive load current switching at maximum of 6 ops/min. MSR127 440R-N23132 has AC-15 inductive load current switching of 5 A @ 250V AC.

Specifications

Standards	EN ISO 13849-1, IEC/EN 60204-1, IEC 60947-5-1, ANSI B11.19, AS 4024.1
Safety Classification	Cat 4 per ISO 13849-1, SIL CL3 per IEC 62061, PLe per ISO 13849-1
Certifications	cULus Listed, c-Tick, and CE Marked for all applicable directives
Enclosure Type Rating/Terminal Protection	IP40, IP20, DIN 0470
Operating Temperature [C (F)]	-5...+55 ° (23...131 °)
Mounting	35 mm DIN Rail
Conductor Size, Max.	0.2...4 mm ² (24...12 AWG)

For more information on our complete family of safety relay products, please visit:
<https://rok.auto/safety-products>



Emergency Stop Devices

SAFETY

Lifeline™ Cable Pull Switches 440E

- Up to 125 m cable span
- Universal mounting and operation
- Lid mounted emergency stop button
- Switch latches when cable is pulled or cable is slack
- Cable status indicator on switch lid
- Lifeline Rope Tensioner System (LRTS) speeds installation



The patented Lifeline 5 Cable Pull Switch is a microprocessor-based solution that brings advanced features and diagnostics that help enhance safety while improving productivity. The Lifeline 5 offers features and functions that simplify setup and allow for more efficient maintenance and troubleshooting, making it the most advanced switch on the market today.



The Lifeline Rope Tensioner System (LRTS) is a unique cable (rope) tensioning system which enables quicker installation of cable actuated systems.

Selection Guide

The patented Lifeline 5 cable pull switch rounds out the family offering that already includes the Lifeline 3 and Lifeline 4.

	Lifeline 5	Stainless Steel Lifeline 4	Lifeline 4	Lifeline 3
Material	Stainless Steel or Die Cast Aluminum	Stainless Steel 316	Painted Aluminum alloy	Painted Zinc alloy
Reset	Yes	Yes	Yes	Yes
E-Stop	Yes	Yes	Yes	No
Cable Span	100 m (328 ft)	75 m (246 ft)	75 m (246 ft) 125 m (410 ft) extended model	30 m (98 ft)

Presence Sensing Devices



5-4...5-19

Interlock Switches



5-20...5-39

Access Control



5-40...5-41

Safety Relays



5-42...5-47

Emergency Stop Devices



5-48...5-49

Safety Limit Switches



5-50...5-51

Product Selection

Lifeline™ Cable Pull Switches

Model	Cable Span	Safety Outputs	Auxiliary Outputs	Cat. No.			
				M20	1/2 in. NPT	5-pin Micro (M12) ²	8-pin Micro (M12) ³
Lifeline 5	≤100 m	2 OSSDs	1 Aux	-	-	440E-LL5N5	-
		2 OSSD Outputs w/ 2 OSSD Inputs	1 Aux, 1 Tension	-	-	-	440E-LL55N8
Lifeline 5 with e-stop		2 OSSDs	1 Aux	-	-	440E-LL55E5	-
		2 OSSD Outputs w/ 2 OSSD Inputs	1 Aux, 1 Tension	-	-	-	440E-LL55E8
Lifeline 5 stainless steel ¹		2 OSSDs	1 Aux	-	-	440E-LL55S5	-
		2 OSSD Outputs w/ 2 OSSD Inputs	1 Aux, 1 Tension	-	-	-	440E-LL55S8
Lifeline 4	≤75 m	2 N.C.	2 N.O.	440E-L13137	440E-L13133	440E-L2NNNYS	440E-L2IBNYH
		3 N.C.	1 N.O.	440E-L13042	440E-L13043	-	-
	75...125 m	2 N.C.	2 N.O.	440E-L13153	440E-L13155	-	440E-L21BTYH
		3 N.C.	1 N.O.	440E-L13150	440E-L13152	-	-
Lifeline 4 stainless steel ¹	≤75 m	2 N.C.	2 N.O.	440E-L22BNSMNH	440E-L22BNSR	-	-
Lifeline 3	≤30 m	2 N.C.	2 N.O.	440E-D13118	440E-D13120	440E-D2NNNYS	440E-D21BNIH
		3 N.C.	1 N.O.	440E-D13112	440E-D13114	-	-

¹ A dedicated stainless steel installation kit must be used with the stainless steel Lifeline instead of the LRTS.

² For standard 5-pin connection, recommended cordset is 889D-F5AC-2; for connection to ArmorBlock Guard I/O, recommended cordset is 889D-F4ACDM-2.

³ For 8-pin connection, recommended cordset is 889D-F8AB-2.

Specifications

Standards	All Lifeline models: IEC 60947-5-5, ISO 13850, IEC 60947-5-1 Emergency stop device in accordance with ISO 13850 Lifeline 5 only: Ple, Cat 4 according to EN ISO 13849-1 SIL CL3 per IEC 62061 and IEC 61508
Functional Safety	Visit https://rok.auto/safety-sr001
Certifications	cULus Listed, TÜV Certified, and CE Marked for all applicable directives https://rok.auto/certifications
Environmental	
Enclosure Type Rating	IP66 (Lifeline 4, Lifeline 5), IP67 (Lifeline 3), IP69K (Lifeline 4 Stainless, Lifeline 5 Stainless)
Operating Temperature [C (F)]	-25...+80° (-13...176°) Lifeline 3, 4 -20...+75° C (-4...167° F) Lifeline 5

Installation Kits⁴

Description	Length	Cat. No.
LRTS installation kit	5 m (16.4)	440E-A13079
	10 m (32.8 ft)	440E-A13080
	20 m (65.6 ft)	440E-A13082
	30 m (98.4 ft)	440E-A13083
	50 m (164 ft)	440E-A13084
	75 m (246 ft)	440E-A13085
Stainless steel installation kit	5 m (16.4 ft)	440E-A13194
	10 m (32.8 ft)	440E-A13195
	15 m (49.2 ft)	440E-A13196
	20 m (65.6 ft)	440E-A13197
	30 m (98.4 ft)	440E-A12198
	50 m (164 ft)	440E-A13199
	75 m (246 ft)	440E-A13200

⁴ 1 x length of cable (rope), 2 x grippers, 1 x tensioner and quantity of eyebolts.



Safety Limit Switches

SAFETY

22 mm Metal and Plastic, 30 mm Metal, and 15 mm Plastic 440P

- Lever and plunger type actuator styles
- Direct opening contacts
- Type 1 interlocking device per ISO 14119
- Replaceable actuators



22 mm Metal and Plastic

Various actuator style options

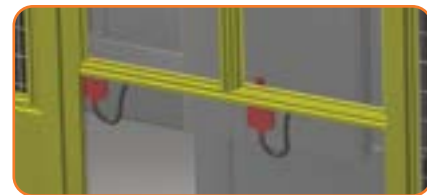
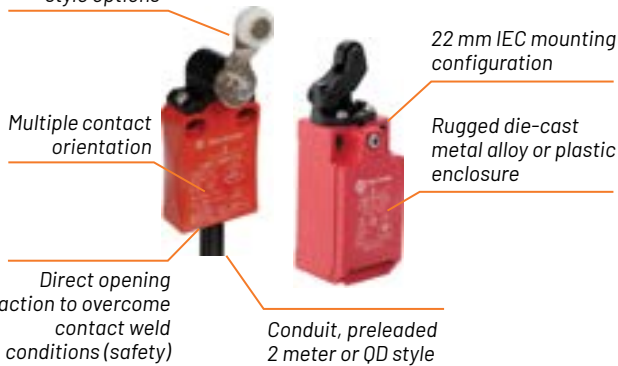

A Full Line of IEC Safety Switches

The 440P limit switch family offers a full range of international-style solutions for both safety and standard sensing applications. Available in four different body styles – 30 mm metal, 22 mm metal and plastic, and 15 mm plastic – with a broad selection of operator types, circuit arrangements and connection options, the 440P is ideal for a wide variety of applications. These include material handling, packaging, elevators, escalators, scissor lifts, industrial trucks and tractors, cranes and hoists, overhead door as well as general safety guarding applications.

30 mm Metal

Various actuator style options

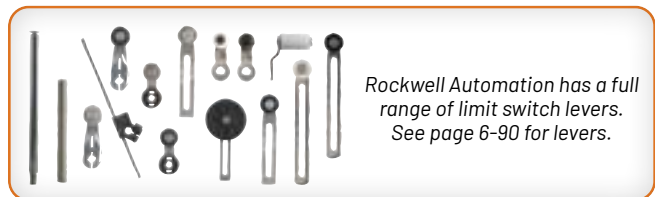
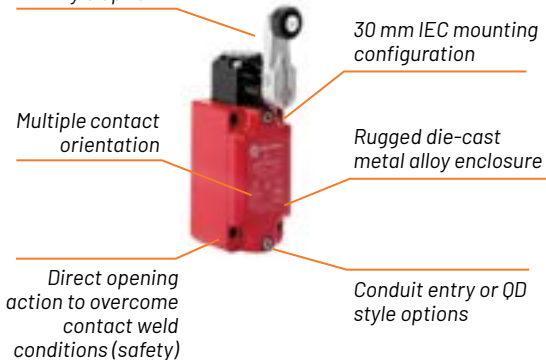

5-50

Presence Sensing Devices



5-4...5-19

Interlock Switches



5-20...5-39

Access Control



5-40...5-41

Safety Relays



5-42...5-47

Emergency Stop Devices



5-48...5-49

Safety Limit Switches



5-50...5-51

Product Selection

22 mm Metal and Plastic, 30 mm Metal, and 15 mm Plastic

Description		Safety Contacts	Auxiliary Contacts	Contact Type	1/2 in. NPT Conduit	M20 Conduit	Quick Disconnect
30 mm metal	Metal roller plunger	1 N.C.	1 N.O.	Snap acting	440P-MRPST1E	440P-MRPST1B	440P-MRPST1N5
		2 N.C.	2 N.O.	BBM	440P-MRPB22E	440P-MRPB22B	440P-MRPB22M9
	Short lever, plastic roller	1 N.C.	1 N.O.	Snap acting	440P-MSLS1E	440P-MSLS1B	440P-MSLS1N5
		2 N.C.	2 N.O.	BBM	440P-MSLB22E	440P-MSLB22B	440P-MSLB22M9
	Short lever, metal roller	1 N.C.	1 N.O.	Snap acting	440P-MMHS1E	440P-MMHS1B	440P-MMHS1N5
		2 N.C.	2 N.O.	BBM	440P-MMHB22E	440P-MMHB22B	440P-MMHB22M9
Adjustable lever	1 N.C.	1 N.O.	Snap acting	440P-MALS1E	440P-MALS1B	440P-MALS1N5	
	2 N.C.	2 N.O.	BBM	440P-MALB22E	440P-MALB22B	440P-MALB22M9	
22 mm plastic	Plastic roller plunger	1 N.C.	1 N.O.	Snap acting	440P-CRPS1E	440P-CRPS1B	440P-CRPS1D4
		2 N.C.	1 N.O.	BBM	440P-CRPB12E	440P-CRPB12B	440P-CRPB12R6
	Adjustable lever	1 N.C.	1 N.O.	Snap acting	440P-CALS1E	440P-CALS1B	440P-CALS1D4
		2 N.C.	1 N.O.	BBM	440P-CALB12E	440P-CALB12B	440P-CALB12R6
	Short lever, plastic roller	1 N.C.	1 N.O.	Snap acting	440P-CSLS1E	440P-CSLS1B	440P-CSLS1D4
		2 N.C.	1 N.O.	BBM	440P-CSLB12E	440P-CSLB12B	440P-CSLB12R6

Description	Safety Contacts	Auxiliary Contacts	Contact Type	Cat. No.		
				2 m Bottom Cable	2 m Side Cable	Quick-Disconnect
22 mm metal	1 N.C.	1 N.O.	Snap acting	440P-ARPS1C	440P-ARPS1CS	440P-ARPS1D5
				Dome plunger	440P-ADPS1C	440P-ADPS1CS

Description	Description	Safety Contacts	Auxiliary Contacts	Contact Type	Cat No.
15mm plastic	Roller plunger	1 N.C.	1 N.O.	Snap acting	440P-M18001
	Cross roller Plunger	1 N.C.	1 N.O.	Snap acting	440P-M18002

Specifications

Standards	ISO 14119, IEC 60947-5-1
Functional Safety	Visit https://rok.auto/safety-sr001
Certifications	cULus Listed, TÜV Certified, and CE Marked for all applicable directives https://rok.auto/certifications
Outputs	
Thermal Current	10 A
Switching Current @ Voltage	25 mA @ 5V DC, min.
Operating Characteristics	
Actuation Frequency, Max.	6000 operations per hr.
Mechanical Life	10 million operations

Required Cordsets & Accessories

Description	Cat. No.
4-pin DC micro (M12), 2 m	889D-F4AC-2
6-pin AC micro (M12), 2 m	889R-F6ECA-2
5-pin mini, 2 m	889N-F5AE-6F
12-pin, 9-wire, 2 m	889M-FX9AE-2

Note: For additional information, see Safety Connection Systems (page 4-50).

For more information on our complete family of safety limit switch products, please visit:
<https://rok.auto/safety-products>



Additional Safety Products



CIP Safety over EtherNet/IP™ Encoders 843ES

The 843ES CIP Safety over EtherNet/IP Encoders are designed for safety applications that require speed, direction, or position monitoring safety functions.

- Rated up to and including
 - SIL 3 according to IEC 61800-5-2, IEC 620261 and IEC 61508-1
 - PLe, Cat. 3, according to ISO 13849-1
- Dual Ethernet ports with embedded EtherNet/IP switch for linear networks and Device Level Ring topologies
- 15-bit safety resolution, 18-bit standard resolution, 12-bit multi-turn resolution

* See Sensors pages 6-98 for more information

Additional Safety Products

Our innovative safety products and solutions improve the functional operation of your machinery while helping to increase personnel safety, efficiency and productivity. We offer one of the broadest safety portfolios in the industry to help you achieve both safety and productivity goals in process and discrete manufacturing applications.

- Safety Programmable Controllers
- Safety Input/Output (I/O) Modules
- Safety Motor Control
- Safety Drives and Motion Control



Presence Sensing Devices



5-4...5-19

Interlock Switches



5-20...5-39

Access Control



5-40...5-41

Safety Relays



5-42...5-47

Emergency Stop Devices



5-48...5-49

Safety Limit Switches



5-50...5-51

SENSORS



Photoelectric Sensors

Sensor Selection	6-2
Miniature	6-4
VisiSight	6-6
VisiSight Laser	6-8
VisiSight M20A	6-10
RightSight M30	6-12
RightSight	6-14
RightSight LaserSight	6-16
Series 9000	6-18
18 mm Plastic Cylindrical	6-20
18 mm Metal Cylindrical	6-22
LaserSight 18 mm Metal Cylindrical	6-24
18 mm Stainless Steel Cylindrical	6-26
Long-Range Background Suppression	6-28
Laser & Distance Measurement	6-30
ColorSight™ True Color	6-32
Luminescence	6-34
Measuring and Discrete Light Arrays	6-36
Area and Bin Picking Arrays	6-38
Polarized Light Array	6-40
Optical Fork	6-42
DIN Rail Fiber Optic Amplifier ..	6-44
Fiber Optic Cables Glass and Plastic	6-46

Proximity Sensors

Sensor Selection	6-48
Miniature	6-50
WorldProx	6-52
Stainless Steel - Weld Field Immune	6-58
Food and Beverage	6-62
Weld Field Immune with Equal Sensing	6-64
Weld Field Immune	6-66
Miniature Rectangular	6-68
VersaCube Equal Sensing	6-70
VersaCube General Purpose	6-72
Flat Pack	6-74
Capacitive	6-76

Ultrasonic Sensors

18, 30 and 38.8 mm Plastic Discrete and Analog	6-78
18 mm Metal General Purpose	6-80

Limit Switches

Oiltight Plug-in	6-82
Pre-wired, Factory Sealed	6-86
IEC 30 mm Metal	6-88
Operating Levers	6-90
Compact, Precision and Small Precision	6-92

Encoders

EtherNet/IP	6-94
Sine Cosine/Serial	6-96
CIP Safety with EtherNet/IP Encoder	6-98
General Purpose and Compact Incremental	6-100

Condition Sensing

Integrated Condition Monitoring System	6-102
Solid-State Pressure Sensors ..	6-104
Solid-State Temperature Switches	6-106
Solid-State Flow Switches	6-108
Solid-State Level Switches	6-110

Identification Devices

Code Reader	6-112
High Frequency	6-114

Additional Sensor Products 6-116 |

Photoelectric Sensors

Sensor Selection

Photoelectric Sensors operate by sensing a change in the amount of light that is either reflected or blocked by an object to be detected (target). The change of light could be the result of the presence or absence of the target or as the result in the change of the size, shape, reflectivity or color of a target.

These sensors can be used in applications to detect targets at distances over 300 m.

To successfully apply a photoelectric sensor the following requirements must be clearly understood:

For Your Selection Keep in Mind...

Margin: defined as the measurement of the amount of light from the light source detected by the receiver, expressed as a multiple of the minimum amount of light level required to switch the sensor output. A margin of 2X is reached when the light level received is twice the minimum required to switch the output.

For minimizing maintenance the sensor should be operated at a margin greater than 2X. Detection in dirty environments (or of a low reflectivity target) requires sensors with higher margin.



Light Operate Output (LO): output is ON (energized) when the receiver can see sufficient light from the light source.

Dark Operate Output (DO): output is ON (energized) when the receiver cannot see light from the light source.

Application Considerations

Target	Environmental	Electrical	Installation
Detection Range	Temperature	Supply Voltage	Mounting Space
Object	• High	• DC or AC	Cable Connections
• Shape	• Low	Output Type	• 2 m cable
• Size	Conditions	• PNP, NPN	• Micro M12 QD
• Opacity	• Wet or dry	• SPDT relay, MOSFET	• Pico M8 QD
• Reflectivity	• Clean or dirty	Response Time	Shock/Vibration
• Speed	• Humidity	Analog Outputs	Interference
	Chemical Substances	Communications	• Electrical Noise
	High-pressure Washdown		• Sunlight

Standard Sensing Modes

	Advantages	Precautions
Diffuse 	<ul style="list-style-type: none"> • Ideal for short-range applications • No reflector required • Easy installation/alignment 	<ul style="list-style-type: none"> • Sensing range depends on target's characteristics (color, reflectivity, etc.) • Highly reflective backgrounds may false trigger the sensor • Relatively short sensing distance
Retroreflective 	<ul style="list-style-type: none"> • Moderate sensing distances • Easy to align • Requires mounting and wiring of only one emitter/receiver unit 	<ul style="list-style-type: none"> • Shorter sensing distances than transmitted beam • May detect reflections from shiny objects (see polarized retroreflective) • Reflector required
Transmitted Beam 	<ul style="list-style-type: none"> • High margin for contaminated environments • Longer sensing ranges than other technologies • Most reliable sensing mode for highly reflective objects 	<ul style="list-style-type: none"> • Requires proper alignment • Not recommended for clear object sensing • Space required to mount and wire separate emitter and receiver

Photoelectric Sensors



6-2...6-47

Proximity Sensors



6-48...6-77

Ultrasonic Sensors



6-78...6-81

Limit Switches



6-82...6-93

Encoders



6-94...6-101

Condition Sensing











6-102...6-111

Identification Devices



6-112...6-115

General Purpose Solutions

		Sensing Range												
		100 mm	200 mm	400 mm	600 mm	800 mm	1 m	2 m	4 m	6 m	8 m	10 m	20 m	> 30 m
 <p>42JA VisiSight</p> <ul style="list-style-type: none"> • IP67 enclosure • 360° visible LED status indicators • Visible light source on all models • Selectable light or dark operate adjustment knob • Transmitted beam models available with infrared light source • Input to disable light source on transmitted beam emitter 	<ul style="list-style-type: none"> • Diffuse (1 m) • Background reflection (Adjusted - 350 mm) • Adjustable Background Suppression (100 mm, 350 mm) • Polarized Retroreflective (5 m) • Transmitted Beam (10 m (red), 15 m (IR)) • Clear Object Detection (2.5 m) 													
 <p>42JS VisiSight</p> <ul style="list-style-type: none"> • Industry standard small rectangular (20 mm L x 14 mm W x 33 mm H) enclosure • Visible red LED on all models for ease of alignment • Complementary LO and DO • IP67 enclosure 	<ul style="list-style-type: none"> • Diffuse (250 mm, 800 mm) • Background Suppression (55 mm, 130 mm) • Polarized Retroreflective (3.5 m) • Transmitted Beam (10 m) 													
 <p>42JT VisiSight</p> <ul style="list-style-type: none"> • Industry standard small rectangular (20 mm L x 12 mm W x 34 mm H) enclosure • Push button teach for easy set up • Visible red LED or Laser (Class 1) on all models for ease of alignment • Auto Detection continuously monitors and configures the output automatically to PNP or NPN • LO or DO configurable on every model • IP69K enclosure rating suitable for harsh duty environments 	<ul style="list-style-type: none"> • Diffuse (250 mm, 800 mm) • Adjustable Background Suppression (120 mm, 200 mm, 400 mm) • Polarized Retroreflective (6 m, 13 m) • Transmitted Beam (13 m, 18 m) • Clear Object Detection (2 m) • Color Mark (12 mm) 													
 <p>42AF RightSight M30</p> <ul style="list-style-type: none"> • Universal 30 mm nose and 18 mm base mounts • 360-degree visible status indicator LEDs • Fully sealed IP67/IP69k housing to withstand high-pressure and high/low-temperature washdowns • Dual auto PNP/NPN on DC only and Universal (AC/DC) 	<ul style="list-style-type: none"> • Background Suppression (400 mm, 600 mm, 800 mm, 1200 mm (1.2 m)) • Background reflection (800 mm) • Polarized Retroreflective (10 m) • Transmitted Beam (80 m) 													
 <p>42EF RightSight</p> <ul style="list-style-type: none"> • Universal 18 mm base, nose and thru-hole mounting • High-pressure washdown (IP69K and 1200 PSI) enclosure • Fixed, teachable and adjustable sensitivity • Dual (PNP and NPN) outputs or complementary (LO and DO) models • DC and AC/DC solid state outputs 	<ul style="list-style-type: none"> • Diffuse (500 mm, 700 mm) • Background Suppression (50 mm, 100 mm) • Retroreflective (4.5 m) • Polarized Retroreflective (3 m) • Transmitted Beam (4 m, 8 m, 20 m) • Fiber Optic (Max: Diffuse 275 mm, Transmitted beam 1.5 m) • Sharp Cutoff Diffuse (130 mm) 													
 <p>42CM</p> <ul style="list-style-type: none"> • Industry standard 18 mm enclosure • Metal housing suitable for heavy duty environments • Complementary LO and DO • IP67 enclosure 	<ul style="list-style-type: none"> • Diffuse (100 mm, 400 mm) • Background Suppression (50 mm, 100 mm) • Retroreflective (4 m) • Polarized Retroreflective (3 m) • Transmitted Beam (20 m) 													
 <p>42CA</p> <ul style="list-style-type: none"> • Industry standard 18 mm enclosure • Plastic housing suitable for corrosive environments • Complementary LO and DO • Fast response time (0.5 ms) models • IP67 enclosure 	<ul style="list-style-type: none"> • Diffuse (100 mm, 400 mm, 1 m) • Background Suppression (50 mm, 100 mm) • Retroreflective (4.8 m, 7.2 m) • Polarized Retroreflective (3.8 m) • Transmitted Beam (16 m) 													
 <p>42KD</p> <ul style="list-style-type: none"> • Our smallest rectangular photoelectric sensor • Ranges up to 3 m • IP67 enclosure • Auto PNP/NPN • Push button teach • Through-hole or dovetail clamp mounting • Visible red 	<ul style="list-style-type: none"> • Fixed Background Suppression (15 mm, 30 mm, 50 mm) • Adjustable Background Suppression (70 mm) • Polarized Retroreflective (1.6 m) 													



Photoelectric Sensors

SENSORS

Miniature 42KD

- Our smallest rectangular photoelectric sensor
- Ranges up to 3 m (9.74 ft)
- IP67 enclosure rating
- Auto PNP/NPN
- Push button teach
- Through-hole or dovetail clamp mounting
- Visible red



Our Smallest Photoelectric Sensor Package

The 42KD sensors, designed for applications with limited mounting space, offer the performance of much larger sensors in a compact housing. This family of LED and laser sensors is the most complete family of miniature sensors on the market. Additionally, these sensors offer easy commissioning via push button teach or through a control wire. The background suppression versions provide reliable object detection independent of the target size, shape, or color.



Bottling application – A 42KD ensures a bottle cap is in place prior to a cartoning process

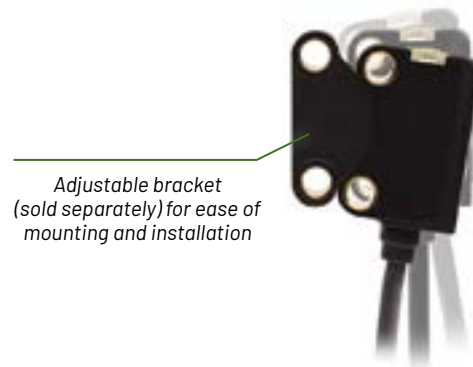
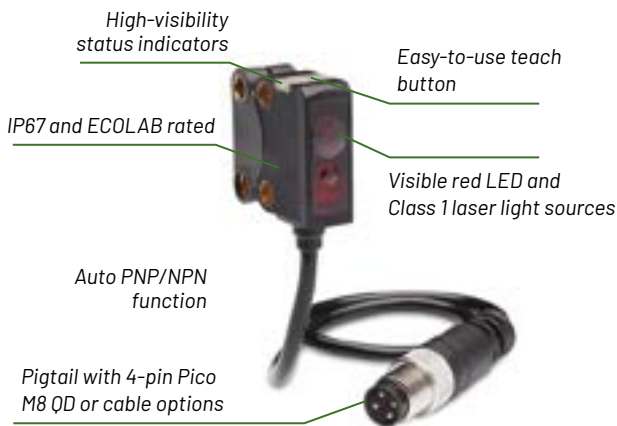

Adjustable bracket (sold separately) for ease of mounting and installation

Photoelectric Sensors



6-2...6-47

Proximity Sensors



6-48...6-77

Ultrasonic Sensors



6-78...6-81

Limit Switches



6-82...6-93

Encoders



6-94...6-101

Condition Sensing



6-102...6-111

Identification Devices



6-112...6-115

Product Selection

42KD Miniature

Sensing Mode	Light Source	Sensing Distance	Sensitivity Adjustment	Output Configuration	Response Time	Cat. No. ¹
Polarized retroreflective	Visible red	0.1...1.6 m (0.33...5.25 ft)	Teach button	Teachable light or dark operate, auto PNP or NPN	0.5 ms	42KD-P2LAT1-Y4
Background suppression	Visible red	1...15 mm (0.04...0.59 in.)	None	Selectable light or dark operate by remote teach, auto PNP or NPN	0.5 ms	42KD-B2LAR1-Y4
		1...30 mm (0.04...0.59 in.)				42KD-B2LAR2-Y4
		1...50 mm (0.04...1.18 in.)				42KD-B2LAR3-Y4
		5...70 mm (0.2...2.75 in.)	Teach button	Teachable light or dark operate, auto PNP or NPN		42KD-B2LAT1-Y4

¹ The **-Y4** suffix describes a 4-pin Pico (M8) QD connector on a 150 mm (6 in.) pigtail.

Specifications

Certifications	cULus Listed and CE Marked for all applicable directives
Enclosure Type Rating	IP67
Operating Temperature [C (F)]	-20...+50 ° (-4...+122 °)
Operating Voltage	10...30V DC, 30 mA
Protection Type	Reverse polarity, short circuit
Output Current	50 mA
Housing Material	PUR
Lens Material	PMMA
Cover Material	PMMA

Required Cordsets and Accessories

Description	Cat. No.
DC Pico (M8) QD cordset, straight, 4-pin, 2 m (6.6 ft)	889P-F4AB-2
DC Pico (M8) QD cordset, right angle, 4-pin, 2 m (6.6 ft)	889P-R4AB-2
Reflector, Micro cube, 51 x 61 mm (2 x 2.5 in.)	92-118
42KD Swivel mounting bracket	42KD-BKT1



Need Help?

The Rockwell Automation Support Center is your 24/7 support for the answers you need now.

<https://rok.auto/support>



Photoelectric Sensors

SENSORS

VisiSight™ 42JS and 42JT

- Industry standard 25.4 mm (1.0 in.) mounting
- Ranges up to 13 m (42.65 ft)
- IP69K and 1200 psi washdown rating (with ECOLAB) for 42JT
- Auto PNP/NPN (42JT only)
- Push button teach (42JT only)
- IO-Link enabled (42JT only)



A Compact General-purpose Solution

The 42JS and 42JT VisiSight sensors offer a small rectangular package with visible light beam for ease of alignment and 25.4 mm industry standard mounting hole spacing.

The 42JS is a basic, cost-effective model ideal for general purpose applications. The 42JT is an advanced line that features push button teach and a unique "Auto PNP/NPN" output that simplifies installation and reduces the number of models to be stocked by 50%.



Clear object detection – clear objects such as bottles are difficult for standard sensors to detect because they see through the target. The 42JT clear object sensor reliably detects these objects thanks to specialized optics.



Photoelectric Sensors



6-2...6-47

Proximity Sensors



6-48...6-77

Ultrasonic Sensors



6-78...6-81

Limit Switches



6-82...6-93

Encoders



6-94...6-101

Condition Sensing



6-102...6-111







Identification Devices



6-112...6-115

Product Selection

VisiSight™

Sensing Mode	Sensing Distance	Sensitivity Adjustment	Light Source	Output Function	Cat. No. ¹
Polarized retroreflective	0.025...3.5 m (0.08...11.5 ft)	None	Visible red	Complementary L.O./D.O., PNP	42JS-P2MPB1-F4
		Adjustment knob			42JS-P2MPA2-F4
	0.1...6 m (0.33...19.7 ft)	Teach button		Teachable L.O./D.O., Auto PNP/NPN	42JT-P2LAT1-F4 
Diffuse	3...250 mm (0.12...9.84 in.)	Adjustment knob	Visible red	Complementary L.O./D.O., PNP	42JS-D2MPA2-F4
	3...800 mm (0.12...31.5 in.)				42JS-D2MPA1-F4
		Teach button		Teachable L.O./D.O., Auto PNP/NPN	42JT-D2LAT1-F4 
Background suppression	2...130 mm (0.07...5.12 in.)	None	Visible red	Complementary L.O./D.O., PNP	42JS-B2MPB2-F4
	6...55 mm (0.24...2.17 in.)				42JS-B2MPB1-F4
	1...180 mm (0.04...7.1 in.)	Teach button		Teachable L.O./D.O., Auto PNP/NPN	42JT-B2LAT1-F4 
	3...400 mm (0.12...15.75 in.)				42JT-B2LAT2-F4 
Clear object detection	2 m (6.6 ft)	Teach button	Visible red		42JT-C2LAT1-F4 
Color mark	12 mm (0.47 in.) ±2.5 mm			White LED	Teachable L.O./D.O., PNP or NPN (push/pull)
Transmitted beam emitter	10 m (32.8 ft)	None	Infrared	NA	42JS-E1EZB1-F4
Transmitted beam receiver		Adjustment knob		Complementary L.O./D.O., PNP	42JS-R9MPA2-F4
Transmitted beam emitter	10 m (32.8 ft)	None	Visible red	NA	42JS-E2EZB1-F4
Transmitted beam receiver		Adjustment knob		Complementary L.O./D.O., PNP	42JS-R9MPA1-F4
Transmitted beam emitter	13 m (42.65 ft)	None	Visible red	NA	42JT-E2EZB1-F4 
Transmitted beam receiver		Teach button		Teachable L.O./D.O., Auto PNP/NPN	42JT-R9LAT1-F4 

¹ The **-F4** suffix describes a 4-pin DC Micro (M12) QD connector on a 150 mm (6 in.) pigtail.

 IO-Link enabled.

Specifications

Certifications	cULus Listed and CE Marked for all applicable directives
Enclosure Type Rating	42JS: IP67; 42JT: IP67 and IP69K
Operating Temperature [C (F)]	-20...+60 ° (-4...+140 °)
Operating Voltage	10...30V DC (25 mA for 42JS, 30 mA for 42JT)
Protection Type	False pulse, reverse polarity, overload, short-circuit
Load Current, Max.	100 mA max.
Housing Material	ABS
Lens Material	PMMA
Cover Material	PMMA

Required Cordsets and Accessories

Description	Cat. No.
DC Micro (M12) QD cordset, straight, 4-pin, 2 m (6.6 ft)	889D-F4AC-2
Mounting bracket, stainless steel, I-shaped for 42JT and 42JS	60-BJS-L1
Mounting bracket, stainless steel, I-shaped for 42JT and 42JS VisiSight	60-BJT-L2
Mounting bracket, plastic, swivel/tilt for 42JS and 42JT VisiSight	60-2619
Protective mounting bracket, stainless steel, u-shaped for 42JT and 42JS	60-BJT-U1
18 mm snap-on adaptor (42JS Only)	60-AJS-18
Reflector, corner cube, 76 mm (3 in.) diameter	92-124
Reflector, corner cube, 84 mm (3.3 in.) diameter	92-125
Reflector, Micro cube, 51 x 61 mm (2 x 2.5 in.) for laser and clear object models	92-118
Ethernet/IP Point I/O	1734-AENTR
Point I/O IO-Link Master Module	1734-4IOL
ArmorBlock IO-Link Master	1732E-8IOLM12R

For more information on our complete family of photoelectric products, please visit:
<https://rok.auto/presence-sensing>



Photoelectric Sensors

SENSORS

VisiSight™ Laser 42JT

- Class 1 eye safe visible laser for small object detection
- Industry standard 25.4 mm (1.0 in.) mounting
- Ranges up to 18 m (59.05 ft)
- IP69K (with ECOLAB)
- Auto PNP/NPN
- Push button teach



Our Compact, Easy-to-use Laser-based Solution

Laser sensors are ideal for small object detection or in applications requiring a narrow field of view. In most cases, laser sensors offer better operating margin and/or longer sensing distances than their LED-based counterparts. The 42JT VisiSight family offers a wide range of sensing modes and a teach push button that simplifies sensitivity adjustment and offers light vs. dark operate output selection. The unique “Auto PNP/ NPN” output continuously monitors how the load is connected and automatically configures the output for proper operation and output LED to indicate correct output status. Not only do these features make the 42JT VisiSight easy to apply in challenging packaging and assembly applications, but they help optimize your supply chain by reducing the number of models to be stocked by 50%.

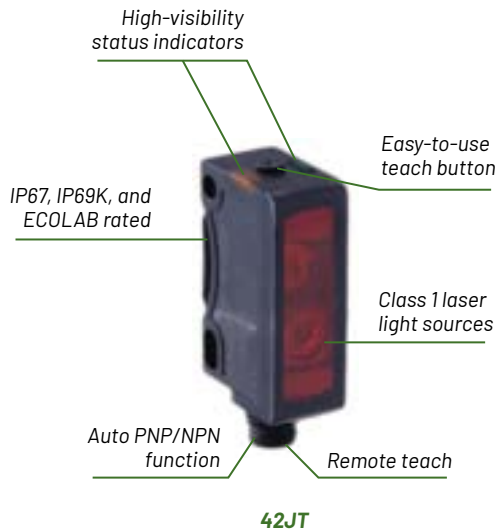

Bottling inspection - When the single 42JT LaserSight mounted on the side of the conveyor senses the bottle carton, it triggers the three standard VisiSights above to check for missing bottles.

Photoelectric Sensors



6-2...6-47

Proximity Sensors



6-48...6-77

Ultrasonic Sensors



6-78...6-81

Limit Switches



6-82...6-93

Encoders



6-94...6-101

Condition Sensing



6-102...6-111





Identification Devices



6-112...6-115

Product Selection

42JT VisiSight™ Laser

Sensing Mode	Sensing Distance	Sensitivity Adjustment	Light Source	Output Function	Cat. No. ¹
Background suppression	4...120 mm (0.16...4.72 in.)	Teach button	Class 1 laser	Teachable L.O./D.O., Auto PNP/NPN	42JT-B8LAT1-F4 
Diffuse	5...250 mm (0.20...9.84 in.)				42JT-D8LAT1-F4 
Polarized retroreflective	0.1...13 m (0.33...42.7 ft)				42JT-P8LAT1-F4 
Transmitted beam emitter	18 m (59.05 ft)	None		NA (emitter)	42JT-E8EZB1-F4 
Transmitted beam receiver		Teach button		Teachable L.O./D.O., Auto PNP/NPN	42JT-R8LAT1-F4 

¹ The -F4 suffix describes a 4-pin DC Micro (M12) integral QD connector.

 IO-Link enabled.

Sales Offices and Distributors

Our network of sales offices and distributors offers exceptional knowledge and service to help you design, implement and support your automation investment.

<https://rok.auto/buy>



Specifications

Certifications	cULus Listed and CE Marked for all applicable directives
Enclosure Type Rating	IP67 and IP69K
Operating Temperature [C (F)]	-20...+60 ° (-4...+140 °)
Operating Voltage	10...30V DC, 30mA
Protection Type	False pulse, reverse polarity, overload, short circuit
Load Current	100 mA max.
Housing Material	ABS
Lens Material	PMMA
Cover Material	PMMA

Required Cordsets and Accessories

Description	Cat. No.
DC Micro (M12) QD cordset, straight, 4-pin, 2 m (6.6 ft)	889D-F4AC-2
Mounting bracket, stainless steel, L-shaped for 42JT and 42JS	60-BJS-L1
Mounting bracket, stainless steel, L-shaped for 42JT and 42JS	60-BJT-L2
Mounting bracket, plastic, swivel/tilt for 42JT	60-2619
Protective mounting bracket, stainless steel, U-shaped for 42JT and 42JS	60-BJT-U1
Reflector, Micro cube, 51 x 61 mm (2 x 2.5 in.)	92-118
Reflector, Micro cube, 20 x 32 mm (0.79 x 1.26 in.) with mounting tabs	92-134
Ethernet/IP Point I/O	1724-AENTR
Point I/O IO-Link Master Module	1734-4IOL
ArmorBlock IO-Link Master	1732E-8IOLM12R

For more information on our complete family of photoelectric products, please visit:
<https://rok.auto/presence-sensing>



Photoelectric Sensors

SENSORS

VisiSight™ M20A 42JA

- IP67 enclosure
- 360° visible LED status indicators
- Visible light source on all models
- Selectable light or dark operate adjustment knob
- Wide range of sensing modes
- Transmitted beam models available with infrared light source
- Input to disable light source on transmitted beam emitter



An Economical and easy-to-apply global sensing solution



The VisiSight™ family of photoelectric sensors are ideal for material handling, packaging and assembly applications. The VisiSight also address the small form factor needs of many other industries including Life Sciences, Pharmaceutical, Food and Beverage and Home, Health and Beauty. VisiSight sensors offer a wide range of sensing modes, mounting options and unique features that make them optimal solutions for global use.



Photoelectric Sensors



6-2...6-47

Proximity Sensors



6-48...6-77

Ultrasonic Sensors



6-78...6-81

Limit Switches



6-82...6-93

Encoders



6-94...6-101

Condition Sensing



6-102...6-111

Identification Devices



6-112...6-115

Product Selection

42JA VisiSight™ M20A

Sensing Mode	Light Source	Sensing Distance	Sensitivity Adjustment	Output Function	Output Type	Cat. No. ¹
Polarized Retroreflective	Visible red	0.01 ... 5 m (0.3...16.4 ft) with 92-125 reflector	Adjustable knob	Selectable light or dark operate	NPN	42JA-P2LNA1-F4
					PNP	42JA-P2LAT1-F4
Clear Object Detection	Visible red	0.01 ... 2.5 m (0.3...8.2 ft) with 92-125 reflector	Adjustable knob	Selectable light or dark operate	NPN	42JA-C2LNA1-F4
					PNP	42JA-C2LAT1-F4
Diffuse	Visible red	3...1000 mm (0.1...39.4 in.)	Adjustable knob	Selectable light or dark operate	NPN	42JA-D2LNA1-F4
					PNP	42JA-D2LAT1-F4
Wide Angle Diffuse	Visible red	0...200 mm (0...7.9 in.)	Adjustable knob	Selectable light or dark operate	PNP	42JA-W2LPA1-F4
Background Suppression	Visible red	3...100 mm (0.1...3.9 in.)	Adjustable knob	Selectable light or dark operate	NPN	42JA-B2LNA1-F4
					PNP	42JA-B2LPA1-F4
		3...350 mm (0.1...13.8 in.)			NPN	42JA-B2LNA2-F4
					PNP	42JA-B2LPA2-F4
Background Reflection	Visible red	3...350 mm (0.1...13.8 in.)	Adjustable knob	Selectable light or dark operate	NPN	42JA-N2LNA2-F4
					PNP	42JA-N2LPA2-F4
Transmitted Beam	Visible red	10 m (32.8 ft)	No Adjustable knob	Selectable light or dark operate	N/A	42JA-E2EZB1-F4
			Adjustable knob		NPN	42JA-R2LNA1-F4
			Adjustable knob		PNP	42JA-R2LPA1-F4
	Infrared	15 m (49.2 ft)	No Adjustable knob		N/A	42JA-E1EZB1-F4
			Adjustable knob		NPN	42JA-R1LNA1-F4
			Adjustable knob		PNP	42JA-R1LPA1-F4

¹ Connection options: The following suffixes describe the available connection options:
 -F4: Describes a 4-pin DC micro (M12) quick-disconnect on a 300 mm (11.8 in.) length pigtail
 -P4: Describes a 4-pin Pico (M8) quick-disconnect on a 300 mm (11.8 in.) length pigtail
 -Y4: Describes a 4-pin Pico (M8) quick-disconnect on a 300 mm (11.8 in.) length pigtail
 -A2: Describes a 2 m (6.6 ft) PVC cable

Additional connection options may be available. See <https://rok.auto/configuration> for available options by sensing mode.

Specifications

Certifications	CE and cULus
Enclosure Type Rating	IP67
Operating Temperature [C (F)]	-30...+60 °C (-22...+140 °F)
Operating Voltage	10...30V DC
Response Time	Diffuse 0.5 ms Wide angle diffuse 0.5 ms Background suppression 1 ms Background reflection 1 ms Polarized retroreflective 0.5 ms Transmitted beam 2 ms Clear object detection 0.5 ms
Load Current	100 mA max.
Housing Material	Polycarbonate

Required Cordsets and Accessories

Description	Cat. No.
DC Micro (M12) QD cordset, straight, 4-pin, 2 m (6.6 ft)	889D-F4AC-2
Mounting bracket, stainless steel, I-shaped for 42JT and 42JS	60-BJS-L1
Mounting bracket, stainless steel, I-shaped for 42JT and 42JS VisiSight	60-BJT-L2
Mounting bracket, plastic, swivel/tilt for 42JS and 42JT VisiSight	60-2619
Protective mounting bracket, stainless steel, u-shaped for 42JT and 42JS	60-BJT-U1
18 mm snap-on adaptor (42JS Only)	60-AJS-18
Reflector, corner cube, 76 mm (3 in.) diameter	92-124
Reflector, corner cube, 84 mm (3.3 in.) diameter	92-125
Reflector, Micro cube, 51 x 61 mm (2 x 2.5 in.) for laser and clear object models	92-118
Ethernet/IP Point I/O	1734-AENTR
Point I/O IO-Link Master Module	1734-4IOL
ArmorBlock IO-Link Master	1732E-8IOLM12R

For more information on our complete family of photoelectric products, please visit:
<https://rok.auto/presence-sensing>



Photoelectric Sensors

SENSORS

RightSight™ M30 42AF

- Universal 30 mm nose and 18 mm base mounts
- 360-degree highly visible status indicator LEDs
- Dual auto PNP/NPN
- 4 Available sensing modes:
 - Background suppression
 - Background reflection
 - Polarized retroreflective
 - Transmitted beam
- IP67, 1,200 psi and IP69k rated



High-power, mid-size solution

The RightSight M30 addresses the challenges of a wide range of industries and applications. The rugged IP67/IP69k housing is also fully sealed, allowing the RightSight M30 to withstand tough industrial environments, including those involving high-pressure and high-temperature washdowns.



Photoelectric Sensors



6-2...6-47

Proximity Sensors



6-48...6-77

Ultrasonic Sensors



6-78...6-81

Limit Switches



6-82...6-93

Encoders



6-94...6-101

Condition Sensing



6-102...6-111

Identification Devices



6-112...6-115

Product Selection

42AF RightSight™ M30



Sensing Mode	Operating Voltage	Light Source	Sensing Distance	Sensitivity Adjustment	Output Function	Output Type	Catalog Number
Background Suppression	10...30V DC	Infrared	Default setting: 10...400 mm (0...15.7 in.)	No physical adjustment. IO-Link teach: 4 m ¹	Light and dark operate	Dual auto PNP or NPN	42AF-B1MAB1-D4
			Default setting: 10...600 mm (0...23.6 in.)	No physical adjustment. IO-Link teach: 4 m ¹			42AF-B1MAB2-D4
			Default setting: 10...1.2 m (0...3.9 ft)	Push button teach: 3 m IO-Link teach: 4 m ¹			42AF-B1MAC1-D4
			0...800 mm (0...31.5 in.)	Push button teach: 3 m IO-Link teach: 4 m ¹			42AF-N1MAC1-D4
Background Reflection							
Polarized Retroreflective	10...30V DC	Visible red	0.025...10 m (0.03...33 ft) with 92-125 reflector	No adjustment (IO-Link adjustable)	Light and dark operate	Dual auto PNP or NPN	42AF-P2MAB1-D4
	20...250V DC 24...250V AC			No adjustment	Light operate	SPDT EM relay	42AF-P2RHB1-G4
					Dark operate		42AF-P2SHB1-G4
					Light and dark operate		42AF-P2CHB1-A2
Transmitted Beam	10...30V DC	Infrared	0...80 m (0...262 ft)	No adjustment (IO-Link adjustable)	Transmitted beam emitter	N/A	42AF-E1EZB1-D4
	20...250V DC 24...250V AC						42AF-E1UZB1-G4
	10...30V DC 20...250V DC 24...250V AC			No adjustment	Light and dark operate	Dual auto PNP or NPN	42AF-R1MAB1-D4
					Light operate	SPDT EM relay	42AF-R1RHB1-G4
					Dark operate		42AF-R1SHB1-G4
					Light and dark operate		42AF-R1CHB1-A2

☑ IO-Link enabled.

Connection Options: The following suffixes describe the available connection options:

- D4: Describes an integral 4-pin DC micro (M12) quick-disconnect for DC models
- G4: Describes a 4-pin AC micro (M12) quick-disconnect on a 150 mm (6 in.) length pigtail on AC/DC models
- F4: Describes a 4-pin DC micro (M12) quick-disconnect on a 150 mm (6 in.) length pigtail on DC models
- A2: Describes a 2 m PVC cable
- M4: Describes a 4-pin mini quick-disconnect on a 150 mm (6 in.) length pigtail. Transmitted beam emitter only.
- M5: Describes a 5-pin mini quick-disconnect on a 150 mm (6 in.) length pigtail on AC/DC models. Polarized retroreflective and transmitted beam receivers only.

¹ Sensor response time can be changed up to 75 ms to achieve distance of up to 4 m. A higher distance between target and high reflectivity background may be needed when operating the sensors at distances greater than 2 m.

Additional connection options may be available. Refer to ProposalWorks for available options by sensing mode.

Specifications

Certifications	CCC, cULus and CE marked for all applicable directives
Enclosure Type Rating	IP67, IP69K
Operating Temperature [C (F)]	-40...+70 °C (-40...158 °F) ¹
Operating Voltage	DC models: 10...30V DC, IO-Link: 18...30V AC/DC models: 20...250V DC 24...250V AC AC/DC: Reverse polarity
Load Current	DC: 100 mA max AC/DC SPDT: 10...30V DC: 3 A 31...125V DC: 200 mA 24...250V AC: 3 A
Housing Material	PBT
Lense Material	PMMA

¹ The sensing range for all sensing modes can be reduced up to 20% when operated between -40...-25 °C (-40...-13 °F).

Mounting Accessories

Description	Cat. No.
DC micro cordset , 4-pin, 2 m (6.5 ft)	889D-F4AC-2
18 mm straight bracket	60-2656
18 mm right angle bracket	60-2657
30 mm stainless steel mounting bracket	60-2421
30 mm swivel/tilt bracket	60-2439
18 mm swivel/tilt bracket	60-2649
76 mm (3 in.) diameter reflector	92-39
47 mm (1.85 in.) diameter reflector	92-47
84 mm (3.3 in.) diameter reflector	92-125

For more information on our complete family of photoelectric products, please visit:
<https://rok.auto/presence-sensing>



Photoelectric Sensors

SENSORS

RightSight™ 42EF

- Universal 18 mm mounting
- Ranges up to 20 m (65.6 ft)
- IP69K and 1200 psi washdown rating
- Non-adjustable, adjustable and teach models
- 360° visible LED indicators
- ECOLAB on cable models
- IO-Link enabled (select models)



The Industry Standard for Durability and Performance

Many applications can be solved with a smaller sensor, but don't be fooled – this durable and rugged sensor has become the standard in many material handling applications. The polarized retroreflective has a maximum sensing range of 3 m (9.8 ft). It also requires much less space for mounting.



Material handling application – A retroreflective RightSight detecting packages on a conveyor line.

Photoelectric Sensors



6-2...6-47

Proximity Sensors



6-48...6-77

Ultrasonic Sensors



6-78...6-81

Limit Switches



6-82...6-93

Encoders



6-94...6-101

Condition Sensing



6-102...6-111





Identification Devices



6-112...6-115

Product Selection

42EF RightSight™

Sensing Mode	Operating Voltage	Light Source	Sensing Distance	Sensitivity Adjustment	Output Function	Cat. No. ¹
Retroreflective	10.8...30V DC	Visible red	25 mm...4.5 m (1 in...14.7 ft)	None	D.O., NPN & PNP	42EF-U2KBB-F4
	21.6...264V AC/DC				D.O., N-MOSFET	42EF-U2SCB-G4
Polarized retroreflective	10.8...30V DC		25 mm...3 m (1 in...9.8 ft)		L.O. & D.O., PNP	42EF-P2MPB-F4 
	21.6...264V AC/DC				D.O., N-MOSFET	42EF-P2SCB-G4
Diffuse	10.8...30V DC	Infrared	3...500 mm (0.12...20 in.)	Single-turn knob	L.O. & D.O., PNP	42EF-D1MPAK-F4
			3...500 mm (0.12...20 in.)	Single-turn knob	L.O. & D.O., PNP	42EF-D2MPAK-F4 
	21.6...264V AC/DC		3...700 mm (0.12...27.6 in.)	Teach button	L.O., NPN & PNP	42EF-D1JBCK-F4
			3...500 mm (0.12...20 in.)	Single-turn knob	L.O., N-MOSFET	42EF-D1RCAK-G4
Sharp cutoff diffuse	10.8...30V DC	3...130 mm (0.12...5 in.)	Single-turn knob		L.O. & D.O., PNP	42EF-S1MPA-F4 
	21.6...264V AC/DC			L.O., N-MOSFET	42EF-S1RCA-G4	
Background suppression	10.8...30V DC	Infrared	3...50 mm (0.12...2 in.)	None	L.O. & D.O., PNP	42EF-B1MPBC-F4
			3...100 mm (0.12...3.9 in.)			42EF-B1MPBE-F4
	21.6...264V AC/DC		3...50 mm (0.12...2 in.)		L.O., N-MOSFET	42EF-B1RCBC-G4
			3...100 mm (0.12...3.9 in.)			42EF-B1RCBE-G4
Clear object detection	10.8...30V DC	Visible red	0.025...1 m (0.08...3.3 ft)	Single-turn knob	D.O., NPN & PNP	42EF-C2KBA-F4
	21.6...264V AC/DC				D.O., N-MOSFET	42EF-C2SCA-G4
Transmitted beam emitter	10.8...30V DC	Infrared	20 m (65.6 ft)	None	NA	42EF-E2EZB-F4
	21.6...264V AC/DC					42EF-E1EQZB-G4
Transmitted beam receiver	10.8...30V DC	Visible red			L.O. & D.O., PNP	42EF-R2MPB-F4 
	21.6...264V AC/DC					D.O., N-MOSFET
Large aperture fiber optic	10.8...30V DC	Infrared	Depends on glass fiber optic cable selected on 6-44	Single-turn knob	L.O. & D.O., PNP	42EF-G1MPA-F4
	21.6...264V AC/DC				L.O. N-MOSFET	42EF-G1RCA-G4

¹ The **-F4** suffix describes a 4-pin DC Micro (M12) QD connector on a 150 mm (6 in.) pigtail. The **-G4** suffix describes a 4-pin AC Micro (M12) QD connector on a 150 mm pigtail.

 IO-Link enabled.

Specifications

Certifications	UL Listed, CSA Certified, and CE Marked for all applicable directives
Enclosure Type Rating	NEMA 4X, 6P, IP67 (IEC 529); 1200 psi (8270 kPa) washdown, IP69K
Operating Temperature [C (F)]	-25...+55 ° (-13...+131 °) ≥132V AC/DC -25...+70 ° (-13...+158 °) ≤132V AC/DC
Protection Type	False pulse, reverse polarity, overload, and short-circuit
Output Current	100 mA
Response time	DC models : 1 ms (4 ms for transmitted beam models); AC models: 8.3 ms (16.6 ms for transmitted beam)
Housing Material	Mindel®
Lens Material	Acrylic
Cover Material	Udel®

Required Cordsets and Accessories

Description	Cat. No.
DC Micro (M12) QD cordset, straight, 4-pin, 2 m (6.6 ft)	889D-F4AC-2
AC Micro (M12) QD cordset, straight, 4-pin, 2 m (6.6 ft)	889R-F4AEA-2
Mounting bracket, plastic, swivel/tilt	60-2649
Reflector, round, 76 mm (3 in.) diameter	92-39
Reflector, round, 32 mm (1.25 in.) diameter	92-47
Ethernet/IP Point I/O	1724-AENTR
Point I/O IO-Link Master Module	1734-4IOL
ArmorBlock IO-Link Master	1732E-8IOLM12R

For more information on our complete family of photoelectric products, please visit:
<https://rok.auto/presence-sensing>



Photoelectric Sensors

SENSORS

RightSight™ LaserSight™ 42EF

- Class 1 eye safe visible laser for small object detection
- Universal 18 mm mounting
- Ranges up to 40 m (131.2 ft)
- IP69K rated enclosure for diffuse and transmitted beam
- IP54 for polarized retroreflective
- Non-adjustable, adjustable, and teach models
- 360° visible LED indicators



Ideal for Small Object Detection

Laser sensors are ideal for small object detection or in applications requiring a narrow field of view. In most cases, laser sensors offer better operating margin and/or longer sensing distances than their LED-based counterparts.

The 42EF RightSight LaserSight uses eye-safe Class 1 visible laser light and features the same mounting options as other products in the RightSight product line. Class 1 lasers require no additional safety or protective training or equipment and are safe for general purpose use.

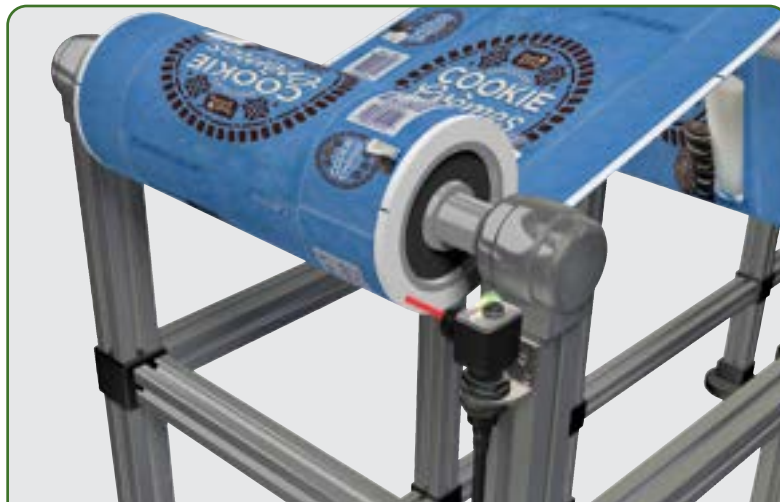

Roll detection - A 42EF RightSight LaserSight monitors a roll of film to indicate low film level.

Photoelectric Sensors



6-2...6-47

Proximity Sensors



6-48...6-77

Ultrasonic Sensors



6-78...6-81

Limit Switches



6-82...6-93

Encoders



6-94...6-101

Condition Sensing



6-102...6-111

Identification Devices



6-112...6-115

Product Selection

42EF RightSight™ LaserSight™

Sensing Mode	Light Source	Sensing Distance	Sensitivity Adjustment	Output Function	Cat. No.
Polarized retroreflective	Class 1 laser	0.05...15 m (0.16...49.2 ft)	Teach button	D.O., NPN & PNP	42EF-P8KBC-F4
Diffuse	Class 1 laser	3...300 mm (0.1...11.8 in.)	Single-turn knob	L.O., NPN & PNP	42EF-D8JBA-F4
			Teach button		42EF-D8JBC-F4



Connected Components
Simpler, faster, cost-effective machine building.
<https://rok.auto/ccw>

Specifications

Certifications	UL Listed, CSA Certified, and CE Marked for all applicable directives
Enclosure Type Rating	IP54 (polarized retroreflective only), All others: IP69K rated
Operating Temperature [C (F)]	-10...+40 ° (14...+104 °)
Operating Voltage	22...26V DC, 30 mA, max.
Protection Type	False pulse, reverse polarity, overload, short-circuit
Output Current	100 mA
Response Time	1 ms (4 ms for transmitted beam models)
Housing Material	Mindel®
Lens Material	Acrylic
Cover Material	Udel®

Required Cordsets and Accessories

Description	Cat. No.
DC Micro (M12) QD cordset, straight, 4-pin, 2 m (6.6 ft)	889D-F4AC-2
Mounting bracket, plastic, swivel/tilt	60-2649
Microcube reflector	92-118



Photoelectric Sensors

SENSORS

Series 9000™ 42G

- Our longest range, full-featured offering - up to 61 m (200 ft)
- IP69K and ECOLAB
- ClearSight™ 9000 clear object detection models
- Series 9000 LaserSight™ models for small object detection
- Standard, timing, and teach models available
- Fiber optic capability



Series 9000



Series 9000 LaserSight

Full-size and Full-featured

Series 9000 general purpose sensors offer many features that help keep you up and running, even in harsh environments. With nearly 300 configurations to choose from – including multiple supply-voltage ranges, output options and connection choices – Series 9000 sensors provide the versatility needed to easily interface with programmable controllers and other electrical loads.

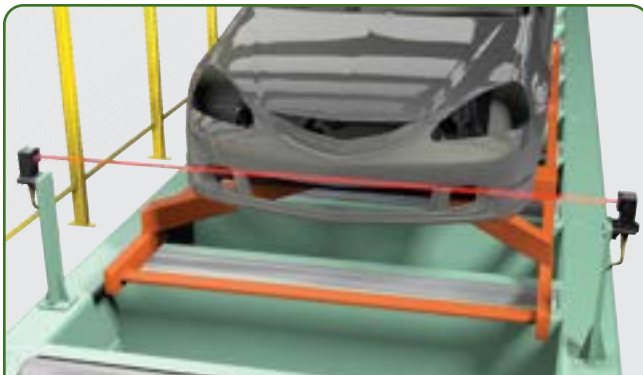

Body shop application - A LaserSight 9000 detecting precise position of a car body skid.

Specifications

Certifications	UL Listed, CSA Approved, and CE Marked for all applicable directives
Enclosure Type Rating	IP69K, IP67 with 1200 psi; NEMA 3, 4X, 6P, 12, 13; ECOLAB rated
Operating Temperature [C (F)]	-34...+70 ° (-29...+158 °) -10...+50 ° (-14...+122 °) LaserSight model
Operating Voltage	10...30V DC, 40...264V AC/DC (see product selection table)
Protection Type	False pulse, reverse polarity, overload, short-circuit
Load Current	250 mA @ 30V DC (all models except 42GLP & 42GSP), 2 A @ 132V AC, 1 A @ 264 V AC (SPDT models)
Housing Material	Thermoplastic polyester resin
Lens Material	Acrylic
Cover Material	Neoprene

Photoelectric Sensors



6-2...6-47

Proximity Sensors



6-48...6-77

Ultrasonic Sensors



6-78...6-81

Limit Switches



6-82...6-93

Encoders



6-94...6-101

Condition Sensing



6-102...6-111

Identification Devices



6-112...6-115

Product Selection

42G Series 9000™

Sensing Mode	Supply Voltage	Light Source	Sensing Distance	Output Function	Cat. No.
Polarized retroreflective	10...30V DC, 30 mA	Visible red	0.050 ... 4.9 m (0.16 ... 16 ft)	Selectable L.O. or D.O., NPN and PNP	42GRU-9200-QD
	70...264V AC/DC			Selectable L.O. or D.O., SPDT EM Relay	42GRU-9202-QD
	40...264V AC, 15 mA			Selectable L.O. or D.O., Solid-state isolated N.O.	42GRU-9203-QD
Diffuse	10...30V DC, 30 mA	Infrared	0.050...1.5 m (0.16...5 ft)	Selectable L.O. or D.O., NPN and PNP	42GLP-9000-QD
	70...264V DC 60...264V AC, 15 mA			Selectable L.O. or D.O., SPDT EM Relay	42GRP-9002-QD
	40...264V AC, 15 mA			Selectable L.O. or D.O., Solid-state isolated N.O.	42GRP-9003-QD
Clear object detection	10...30V DC, 30 mA	Visible red	0.050...1.2 m (0.16...4 ft)	Selectable L.O. or D.O., NPN and PNP	42GRC-9200-QD
	70...264V AC/DC			Selectable L.O. or D.O., SPDT EM Relay	42GRC-9202-QD
	45...264V AC, 15 mA			Selectable L.O. or D.O., Solid-state isolated N.O.	42GRC-9203-QD
Transmitted beam emitter	10...264V AC/DC, 15 mA	Infrared	0.025...61 m (0.83...200 ft)	NA	42GRL-9000-QD
Transmitted beam receiver	10...30V DC, 30 mA			Selectable L.O. or D.O., NPN and PNP	42GRR-9000-QD
	40...264V AC, 10 mA			Selectable L.O. or D.O., Solid-state isolated N.O.	42GRR-9003-QD
Large aperture fiber optic	10...30V DC, 30 mA	Infrared	Depends on fiber optic cable selected on 6-44	Selectable L.O. or D.O., NPN and PNP	42GRF-9000-QD
	70...264V AC/DC, 15 mA			Selectable L.O. or D.O., SPDT EM Relay	42GRF-9002-QD
	40...264V AC, 15 mA			Selectable L.O. or D.O., Solid-state isolated N.O.	42GRF-9003-QD

42G Series 9000™ LaserSight™

Sensing Mode	Sensing Distance	Operating Voltage	Light Source	Output Configuration	Cat. No. ¹
Polarized retroreflective	0.3 ... 40 m (1 ... 130 ft)	10...30V DC, 45 mA	Class 1 laser	Selectable L.O. or D.O., NPN and PNP	42GRU-92L0-QD
		110...132V AC, 70 mA		Selectable L.O. or D.O., SPDT EM Relay	42GRU-92L2-QD
Diffuse	800 mm (31.5 in.)	10...30V DC, 45 mA		Selectable L.O. or D.O., NPN and PNP	42GRP-92L0-QD
		110...132V AC, 70 mA		Selectable L.O. or D.O., SPDT EM Relay	42GRP-92L2-QD

¹ The -QD suffix describes a 4-pin DC Micro (M12) integral QD for DC models, a 5-pin mini QD for SPDT EM relay models.

Required Cordsets and Accessories

Description	Cat. No.
DC Micro (M12) QD cordset, straight, 4-pin, 2 m (6.6 ft)	889D-F4AC-2
Mini QD cordset, 4-pin, 1.8 m (6 ft)	889N-F4AF-6F
Mounting bracket, plastic, swivel/tilt	60-2439
Mounting bracket, heavy duty impact	60-2702
Reflector, round, 76 mm (3 in.) diameter	92-39
Reflector, round, 32 mm (1.25 in.) diameter	92-47
Fiber optic cable lens extender	60-2738

For more information on our complete family of photoelectric products, please visit:
<https://rok.auto/presence-sensing>



Photoelectric Sensors

SENSORS

18 mm Plastic Cylindrical 42CA

- 18 mm plastic cylindrical
- Ranges up to 16 m (52.5 ft)
- Extended range high-speed models
- IP67 rating
- Linear sensitivity adjustment
- Stability indication
- Dual LED indicators



A Cost-effective General-purpose Solution

The 42CA 18 mm plastic cylindrical general-purpose sensors are ideal for light to medium duty industrial applications. Five possible sensing modes allow the 42CA to be used in a variety of complex applications. These sensors offer a highly linear sensitivity adjustment, stability indication and excellent noise immunity; making them easy to apply and maintain.

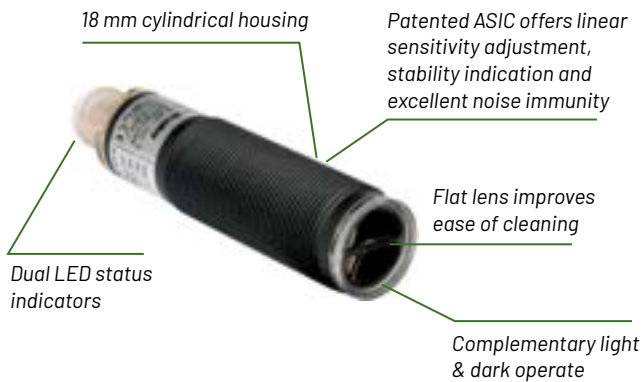

Material handling - Three 42CA sensors detecting boxes of varying sizes from below and in any position across the conveyor width.

Photoelectric Sensors



6-2...6-47

Proximity Sensors



6-48...6-77

Ultrasonic Sensors



6-78...6-81

Limit Switches



6-82...6-93

Encoders



6-94...6-101

Condition Sensing



6-102...6-111

Identification Devices



6-112...6-115

Product Selection

18 mm Plastic Cylindrical

Sensing Mode	Light Source	Sensing Distance	Sensitivity Adjustment	Output Configuration	Response Time	Cat. No. ¹
Retroreflective	Visible red	0.002...4.8 m (0.0 ...15.7 ft)	None	Complementary L.O. & D.O., PNP	1 ms	42CA-U2MPB-D4
		0.002...7.2 m (0.0 ...23.6 ft)	Single-turn potentiometer		0.5 ms	42CA-U2MPA-D4
Polarized retroreflective		0.002...3.8 m (0.0 ...12.5 ft)	None		1 ms	42CA-P2MPB-D4
Standard diffuse	Infrared	0...100 mm (0...3.9 in.)	Single-turn potentiometer		1 ms	42CA-D1MPAE-D4
		0...400 mm (0...15.7 in.)				42CA-D1MPAJ-D4
		0...1 m (0...3.28 ft)				42CA-D1MPAL-D4
Background suppression	Visible red	50 mm (2 in.)	None	Selectable L.O. or D.O., PNP	0.5 ms	42CA-B2LPBC-D4
		100 mm (3.9 in.)				42CA-B2LPBE-D4
Transmitted beam emitter	Infrared	0.003...16 m (0.01...52.5 ft)	None	NA	NA	42CA-E1EZB1-D4
Transmitted beam receiver						Single-turn potentiometer

¹ The **-D4** suffix describes a 4-pin DC Micro (M12) QD connector.

Specifications

Certifications	cULus Listed and CE Marked for all applicable directives
Enclosure Type Rating	IP67
Operating Temperature [C (F)]	-25...+70 ° (-13...+158 °)
Operating Voltage	10...30V DC, 30 mA
Protection Type	Reverse polarity, overload, short-circuit
Load Current	100 mA
Housing Material	PBT
Lens Material	PMMA

Required Cordsets and Accessories

Description	Cat. No.
DC Micro QD cordset, straight, 4-pin, 2 m (6.6 ft)	889D-F4AC-2
DC Micro QD cordset, right angle, 4-pin, 2 m (6.6 ft)	889D-R4AC-2
Mounting bracket, snap-clamp	871A-SCBP18
Mounting bracket, right angle	60-2657
Mounting bracket, swivel/tilt	60-2649
Mounting bracket, straight	60-2656
Spare corner cube reflector (76 mm (3 in.) diameter with mounting hole)	92-39
Spare corner cube reflector (32 mm (1.3 in.) diameter with mounting hole)	92-47

For more information on our complete family of photoelectric products, please visit:
<https://rok.auto/presence-sensing>



Photoelectric Sensors

SENSORS

18 mm Metal Cylindrical 42CM

- Heavy duty 18 mm metal housing
- Ranges up to 20 m (65.6 ft)
- IP67 rating
- Sensitivity adjustment (diffuse models only)



General-purpose Sensing in a Rugged Metal Housing

The 42CM 18 mm Metal Cylindrical General-purpose Sensors are intended for heavy-duty industrial applications requiring an industry standard 18 mm cylindrical housing. Five possible modes of sensing allow the 42CM to be used in a variety of complex applications. Outputs are short-circuit protected to provide continuous operation even under unexpected conditions.

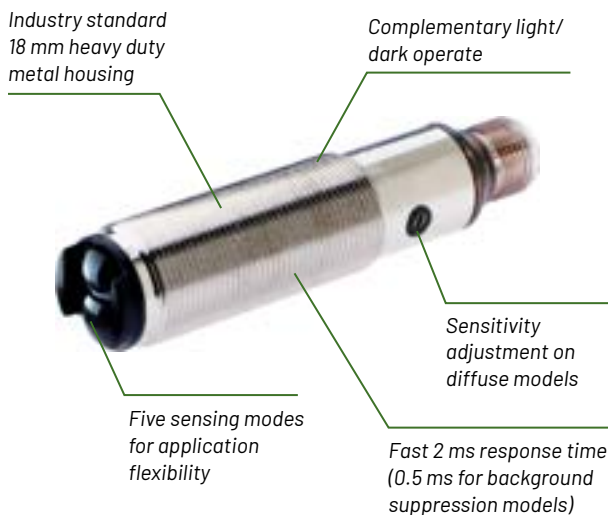

Feeder bowl application - A 42CM monitors bowl level to prevent component runout. This background suppression model ignores reflections from the bowl to accurately detect the components only.

Photoelectric Sensors



6-2...6-47

Proximity Sensors



6-48...6-77

Ultrasonic Sensors



6-78...6-81

Limit Switches



6-82...6-93

Encoders



6-94...6-101

Condition Sensing



6-102...6-111

Identification Devices



6-112...6-115

Product Selection

18 mm Metal Cylindrical

Sensing Mode	Light Source	Sensing Distance	Sensitivity Adjustment	Output Configuration	Response Time	Cat. No. ¹
Retroreflective	Infrared	0.003...4 m (0.0...13.2 ft)	None	Complementary L.O. & D.O., PNP	4 ms	42CM-U1MPB-D4
Polarized retroreflective	Visible red	0.003...3 m (0...9.9 ft)				42CM-P2MPB-D4
Standard diffuse		0...100 mm (0...3.9 in.)	2 ms		42CM-D2MPAE-D4	
		0...400 mm (0...15.7 in.)			42CM-D1MPAL-D4	
Background suppression		50 mm (2 in.)	None	Selectable L.O. or D.O., PNP	0.5 ms	42CM-B2LPBC-D4
	100 mm (3.9 in.)	42CM-B2LPBE-D4				
Transmitted beam emitter	Infrared	3...20 m (0...65.6 ft)	None	NA	NA	42CM-E1EZB-D4
Transmitted beam receiver	Infrared or visible red		Complementary L.O. & D.O., PNP	2 ms	42CM-R1MPB-D4	

¹ The **-D4** suffix describes a 4-pin DC Micro (M12) QD connector.



Need Help?

The Rockwell Automation Support Center is your 24/7 support for the answers you need now.

<https://rok.auto/support>

Specifications

Certifications	cULus Listed and CE Marked for all applicable directives
Enclosure Type Rating	IP67
Operating Temperature [C (F)]	-25...+70 ° (-13...+158 °)
Operating Voltage	10...30V DC, 30 mA
Protection Type	Reverse polarity, overload, short-circuit
Load Current	100 mA
Housing Material	Nickel-plated brass
Lens Material	PMMA/PC

Required Cordsets and Accessories

Description	Cat. No.
DC Micro QD cordset, straight, 4-pin, 2 m (6.6 ft)	889D-F4AC-2
DC Micro QD cordset, right angle, 4-pin, 2 m (6.6 ft)	889D-R4AC-2
Mounting bracket, snap-clamp	871A-SCBP18
Mounting bracket, right angle	60-2657
Mounting bracket, swivel/tilt	60-2649
Mounting bracket, straight	60-2656
Spare corner cube reflector (76 mm (3 in.) diameter with mounting hole)	92-39
Spare corner cube reflector (32 mm (1.3 in.) diameter with mounting hole)	92-47

For more information on our complete family of photoelectric products, please visit:
<https://rok.auto/presence-sensing>



Photoelectric Sensors

SENSORS

LaserSight™ 18 mm Metal Cylindrical 42CM

- Class 1 eye safe visible laser for small object detection
- Heavy duty 18 mm metal housing
- Ranges up to 50 m (164 ft)
- Small 0.1 mm spot size
- IP67 rating



Rugged, Laser-based Sensing

The 42CM 18 mm LaserSight photoelectric laser sensors combine an eye-safe Class 1 visible laser light source and an industry standard cylindrical housing. They are ideal for tough sensing applications that require a longer range, where the environment is dusty, dirty, or when the object to be sensed is small.

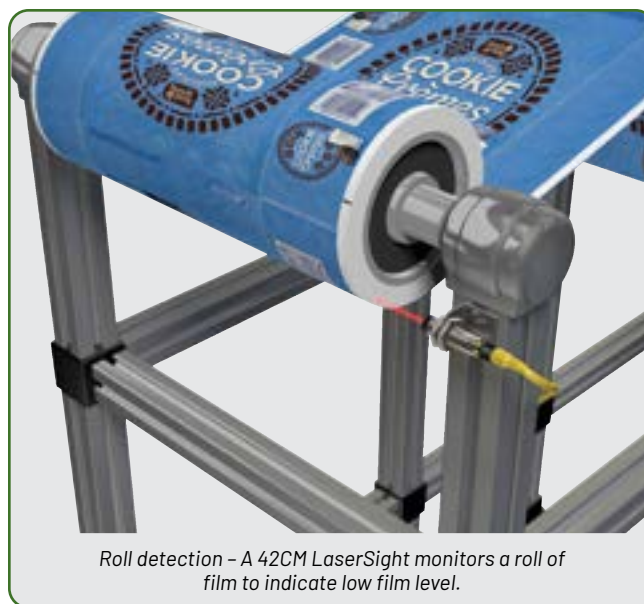

Photoelectric Sensors



6-2...6-47

Proximity Sensors



6-48...6-77

Ultrasonic Sensors



6-78...6-81

Limit Switches



6-82...6-93

Encoders



6-94...6-101

Condition Sensing



6-102...6-111

Identification Devices



6-112...6-115

Product Selection

42CM LaserSight™ 18 mm Metal Cylindrical

Sensing Mode	Light Source	Sensing Distance	Sensitivity Adjustment	Output Configuration	Response Time	Cat. No. ¹
Polarized retroreflective	Class 1 laser	0.003...30 m (0...78 ft)	None	Complementary L.O. and D.O., PNP	0.7 ms	42CM-P8MPB-D4
Diffuse		3...300 mm (0...11.8 in.)	Teach button			42CM-D8MPA-D4
Transmitted beam emitter		3...50 m (0...164 ft)	Potentiometer	NA	NA	42CM-E8EZB-D4
Transmitted beam receiver				Complementary L.O. and D.O., PNP	0.5 ms	42CM-R8MPB-D4

¹ The **-D4** suffix describes a 4-pin DC Micro (M12) QD connector.



Sales Offices and Distributors

Our network of sales offices and distributors offers exceptional knowledge and service to help you design, implement and support your automation investment.

<https://rok.auto/buy>

Specifications

Certifications	cULus Listed and CE Marked for all applicable directives
Enclosure Type Rating	IP67
Operating Temperature [C (F)]	-10...+55 ° (14...131 °)
Operating Voltage	10...30V DC, 25 mA
Protection Type	Reverse polarity, overload, short-circuit
Load Current	100 mA
Housing Material	Nickel-plated brass
Lens Material	Glass

Required Cordsets and Accessories

Description	Cat. No.
DC Micro QD cordset, straight, 4-pin, 2 m (6.6 ft)	889D-F4AC-2
DC Micro QD cordset, right angle, 4-pin, 2 m (6.6 ft)	889D-R4AC-2
Mounting bracket, snap-clamp	871A-SCBP18
Mounting bracket, right angle	60-2657
Mounting bracket, swivel/tilt	60-2649
Mounting bracket, straight	60-2656
Rectangular reflector, 51 x 51 mm (2 x 2 in.)	92-118

For more information on our complete family of photoelectric products, please visit:
<https://rok.auto/presence-sensing>



Photoelectric Sensors

SENSORS

18 mm Stainless Steel Cylindrical 42CS

- Stainless steel 18 mm cylindrical
- Smooth barrel design
- Ranges up to 20 m (65.6 ft)
- IP69K, ECOLAB, and Johnson Diversey rated
- Extended temperature operating range
- Ferromagnetic teach



The Ideal Solution for Food and Beverage Applications

The 42CS stainless steel cylindrical sensors are ideal for food, beverage, and pharmaceutical applications. The smooth, clean design minimizes the collection and accumulation of undesired particles allowing for a fast and easy clean up. An innovative teach feature also simplifies setup – just place a ferromagnetic metal object on a section of the sensor housing to initiate the teach process.

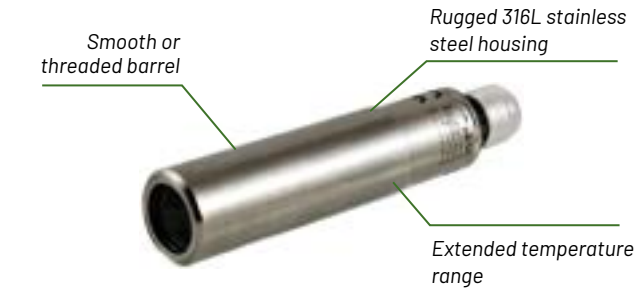

Flush, hardened PMMA lens prevents build-up

Optional block mounting bracket for smooth barrel housing (Cat. No. 60-BCS-18B)



Flap detection - When the single 42CS mounted on the side of the conveyor senses a food package, it triggers the two sensors above to check for open box flaps, ensuring all packages are sealed.

Photoelectric Sensors



6-2...6-47

Proximity Sensors



6-48...6-77

Ultrasonic Sensors



6-78...6-81

Limit Switches



6-82...6-93

Encoders



6-94...6-101

Condition Sensing



6-102...6-111

Identification Devices



6-112...6-115

Product Selection

18 mm Stainless Steel Cylindrical

Sensing Mode	Light Source	Sensing Distance	Sensitivity Adjustment	Output Configuration	Response Time	Cat. No. ¹	
Polarized retroreflective	Visible red	4 m (13.1 ft)	None	Complementary L.O./D.O., PNP	1 ms	42CSS-P2MPB1-D4	
Standard diffuse		Infrared	100 mm (3.9 in.)			Ferromagnetic teach	42CSS-D2MPA1-D4
	400 mm (15.8 in.)		42CSS-D1MPA2-D4				
	800 mm (31.5 in.)		42CSS-D1MPA3-D4				
Background suppression	Visible red	60...100 mm (2.4...3.9 in.)	None		1.25 ms		42CSS-B2MPA1-D4
Clear object detection		1 m (3.2 ft)			1 ms		42CSS-C2MPA1-D4
Transmitted beam emitter	Infrared	0...20 m (0...65.6 ft)	None	NA	NA		42CSS-E1EZB1-D4
Transmitted beam receiver				Complementary L.O./D.O., PNP	2 ms	42CSS-R9MPB1-D4	

¹ The prefix **42CSS** denotes smooth barrel. For threaded models, replace the **42CSS** with **42CST** (e.g., **42CST-P2MPB1-D4**). The **-D4** suffix describes a 4-pin DC Micro (M12) QD connector.



Product Selection Tools

Available online or for download, our tools help you access info while in the office or on the go.

<https://rok.auto/selection>

Specifications

Certifications	cULus Listed and CE Marked for all applicable directives
Enclosure Type Rating	IP69K, ECOLAB, and Johnson Diversey rated
Operating Temperature [C (F)]	-25...+85 ° (-13...+185 °)
Operating Voltage	10...30V DC @ 35 mA max.
Protection Type	Reverse polarity, transient noise, short-circuit
Load Current	100 mA
Housing Material	316 stainless steel
Lens Material	PMMA

Required Cordsets and Accessories

Description	Cat. No.
DC Micro QD cordset, straight, 4-pin, 2 m (6.6 ft)	889D-F4AC-2
DC Micro (M12) QD patchcord	889D-F4ACDM-2
Block mounting bracket for smooth barrel housing	60-BCS-18B
Straight mounting bracket for threaded models	60-2656
Right angle mounting bracket for threaded models	60-2657
Spare corner cube reflector (32 mm (1.26 in.) diameter with mounting hole)	92-47



Photoelectric Sensors

SENSORS

Long-Range Background Suppression 42BT and 42BC

- Adjustable 1 m and 2 m range background suppression
- Slim flat pack housing design
- Infrared LED or red LED
- Selectable L.O. and D.O.
- Dual (PNP and NPN) outputs
- AC/DC relay output models (42BC)



Sensing the Target While Ignoring the Background

Background suppression sensors are designed for applications requiring the sensor to see a target very close to a reflective background. Background suppression is particularly effective when the target and background have similar reflectivities or when dark targets are to be sensed against a lighter, more reflective background. These long range models offer high background suppression performance at sensing ranges up to 2 m (6.6 ft).



Side-by-side conveyors - A 42BT background suppression sensor detects bins on the near conveyor while ignoring bins on the second.

Photoelectric Sensors



6-2...6-47

Proximity Sensors



6-48...6-77

Ultrasonic Sensors



6-78...6-81

Limit Switches



6-82...6-93

Encoders



6-94...6-101

Condition Sensing



6-102...6-111

Identification Devices



6-112...6-115

Product Selection

Long-Range Background Suppression

Sensing Mode	Light Source	Sensing Distance [mm (in.)]	Sensitivity Adjustment	Output Configuration	Response Time	Cat. No.
Background suppression	Visible red	100...1000 (3.94...39.4)	5-turn potentiometer	Selectable L.O./D.O., NPN & PNP	2 ms	42BT-B2LBSL-F4
		100...2000 (3.94...78.7)				42BT-B1LBSN-F4
	Infrared	200...1000 (7.87...39.4)	Adjustment knob	Selectable L.O./D.O., SPST N.O Relay	20 ms	42BC-B1LBAL-T4
						42BC-B1CRAL-T4
		200...2000 (7.87...78.7)		Selectable L.O./D.O., NPN & PNP	30 ms	42BC-B1LBAN-T4
						42BC-B1CRAN-T4



Connected Components
Simpler, faster, cost-effective machine building.
<https://rok.auto/ccw>

Specifications

Certifications	42BT	cULus Listed and CE certified for all applicable directives
	42BC	UL Listed and CSA certified
Enclosure Type Rating	42BT	IP66
	42BC	IP65
Operating Temperature [C (F)]	42BT	-25...+55 ° (-13...+131 °)
	42BC	
Operating Voltage	42BT	12...24V DC
	42BC	12...24V DC, 24...240V AC/DC
Protection Type	42BT	Short circuit
	42BC	Short circuit, reverse polarity, overload
Load Current	42BT	100 mA
	42BC	100 mA, 3A (AC/DC)
Housing Material	42BT	Polyarilate
	42BC	Polycarbonate and acrylic
Lens Material	42BT	Polyarilate
	42BC	

Required Cordsets and Accessories

Description	Cat. No.
DC Micro QD cordset, straight, stainless steel, 4-pin, 2 m (6.6 ft)	889D-F4AC-2
DC Micro (M12) QD receptacle	888D-M4AC1-0M3
Vertical mounting bracket for 42BT	61-6738
Horizontal mounting bracket for 42BT	61-6739
Mounting bracket	60-2637
Replacement cover	60-2669
Mini QD receptacle	60-2668



Photoelectric Sensors

SENSORS

Laser Measurement 45LMS

- Long-range, high performance measurement
- One discrete and one analog (4...20 mA) output
- Push button setup of switch points or analog scaling

PHOTOSWITCH® Distance Measurement 45DMS

- Averaging filter function stabilizes the signal to provide a more constant measurement
- Ability to change the 4-20 mA to 0-10V DC on the analog output models
- Accurate to ± 20 mm (± 1.18 in.) linearity



Compact and Flexible

The 45DMS and 45LMS are great solutions for long range detection/measurement in difficult applications. The 45DMS features a 3-in-1 sensing mode which can be easily interchanged - Distance Measurement, Background Suppression and Background Reflection. Available in three ranges, the 45LMS uses the Time of Flight principle and has a relatively small beam spot, even from a distance of 50 m (164 ft).

	45DMS	45LMS
Distance measurement range	0.06...5 m	0.2...8 m; 0.2...15 m
Light source	Class 1 Laser	
Outputs	1 x Auto PNP/NPN + Remote Teach, 1 x Auto PNP/NPN + 4...20 mA (0-10V via IO-Link)	1 x PNP + 4...20 mA
Linearity	(SYMBOL) ± 30 mm	(SYMBOL) ± 25 mm
Repeatability	1.2 mm (1 sigma)	Less than 5 mm
Resolution	1 mm IO-Link, 5 mm Analog	Less than 5 mm
Response time	2 ms	10 ms
Operating voltage	18...30V DC	10...30V DC
Enclosure size	50 x 50 x 23 mm	94 x 55 x 26 mm
Embedded IO-Link	included	
Enclosure rating	IP67 and IP69K	IP65

Typical 45LMS applications:

- Distance measurement
- Verifying material position
- Stack level
- Roll diameter or thickness measurement
- Fixture positioning
- Error-proofing inspection
- Level monitoring
- Crane crash protection

The 45DMS is ideal for space-limited applications:

- Food and beverage
- Material handling
- Packaging plants

Photoelectric Sensors



6-2...6-47

Proximity Sensors



6-48...6-77

Ultrasonic Sensors



6-78...6-81

Limit Switches



6-82...6-93

Encoders



6-94...6-101

Condition Sensing



6-102...6-111





Identification Devices



6-112...6-115

Product Selection

Distance & Laser Measurement

Sensing Mode	Light Source	Sensing Distance	Sensitivity Adjustment Output Type	Spot Size	Cat. No.
Background suppression	Class 1 Laser	0.06...5 m (90% white) (2.36 in....16.40 ft) 0.06...3 m (6% black) (2.36 in....9.84 ft)	One Push Button Auto PNP or NPN	-	45DMS-B8LAT1-D4 
Background reflection	Class 1 Laser	0.1...5 m (90% white) (3.94 in. to 16.40 ft) 0.1...3 m (6% black) (3.94 in. to 9.84 ft)	Two Push Buttons Auto PNP or NPN	-	45DMS-B8LGT1-D5 
Diffuse	Class 1 laser	0.2...8 m (0.66...26.25 ft)	-	< 10 mm (0.39 in.) at 8 m (26 ft) and 20 °C (68 °F)	45LMS-D8LGC1-D4 
	Class 2 laser	0.2...15 m (0.66...49.21 ft)	-	< 15 mm (0.59 in.) at 15 m (49 ft) and 20 °C (68 °F)	45LMS-D8LGC2-D4 
Retroreflective	Class 1 laser	0.2...50 m (0.66...164.04 ft)	-	< 50 mm (2 in.) at 50 m (164 ft) and 20 °C (68 °F)	45LMS-U8LGC3-D4 

 IO-Link enabled.

Specifications

	45DMS	45LMS
Certifications	cULus listed, and CE marked for all applicable directives	
Enclosure Rating	IP67 and IP69K	IP65
Operating Temperature [C (F)]	-40...+60 °C (-40...+140 °F)	-30...+50 ° (-22...+122 °)
Operating Voltage	18...30V DC	10...30V DC, (18...30V DC in IO-Link mode)
Protection Type	Short circuit, reverse polarity (for discrete output); Short circuit, overload protected (for analog output)	
Load Current	100 mA max.	
Housing Material	ABS	Plastic ABS
Lens Material	PMMA	Plastic pane

Required Cordsets and Accessories

Description	Cat. No.
DC Micro (M12) straight QD cordset, 4-pin, 2 m (6.6 ft)	889D-F4AC-2
DC Micro (M12) right angle cordset, 4-pin, 2 m (6.6 ft)	889D-R4AC-2
Mounting bracket	45LMS-BKT1
Mounting bracket (L shape)	45LMS-BKT2
Weld slag cover	45LMS-BKT3
Stainless steel mounting bracket (L-shape)	60-BDMS-LS
Stainless steel precision mounting bracket	60-BDMS-PS
Bracket for Ø 12 mm mounting rod and 10x10 mm square profile	60-BDMS-RS
Protective stainless steel mounting bracket	60-BDMS-US
Point I/O IO-Link Master Module	1734-4IOL
ArmorBlock IO-Link Master	1732E-8IOLM12R

For more information on our complete family of photoelectric products, please visit:
<https://rok.auto/presence-sensing>



Photoelectric Sensors

SENSORS

ColorSight™ True Color 46CLR

- Three models to address your needs:
 - Glare suppression
 - Small spot size (for small object detection)
 - Long range
- Internally stores up to seven colors in color match mode and unlimited colors by using IO-Link when connected to CompactLogix™



Advanced, High-Performance Color Sensing

The 46CLR was designed to perform the sensing operations commonly found in the automotive, food and beverage, pharmaceutical, and plastics, among other industries.

The 46CLR color sensing solution features patent-pending distance correction technology that confirms consistent color detection at ranges up to 65 mm. Additional features include internal storage of up to seven colors and nine adjustable tolerance levels for optimal application flexibility.

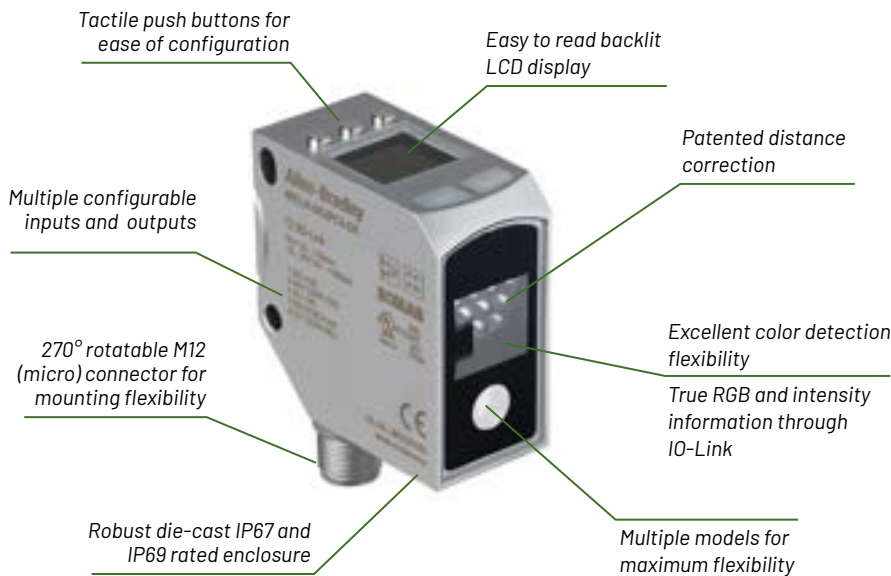

Ideal for a variety of industries:

- automotive
- food and beverage
- pharmaceutical
- plastics

Photoelectric Sensors



6-2...6-47

Proximity Sensors



6-48...6-77

Ultrasonic Sensors



6-78...6-81

Limit Switches



6-82...6-93

Encoders

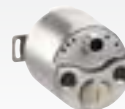

6-94...6-101

Condition Sensing



6-102...6-111



Identification Devices



6-112...6-115

Product Selection

46CLR ColorSight™ True Color

Model	Operating voltage	Light source	Sensing distance	Outputs	Inputs	Cat. No.
Glare Suppression	18...30V DC	White LED	18...32 mm	3 x PNP	Configurable Trigger and Push Button Lock	46CLR-D5LAC1-D5 
Small Spot Size	18...30V DC	White LED	18...60 mm	3 x PNP	Configurable Trigger and Push Button Lock	46CLR-D5LAC2-D5 
Long Range	18...30V DC	White LED	20...150 mm	3 x PNP	Configurable Trigger and Push Button Lock	46CLR-D5LAC3-D5 

 IO-Link enabled.

Specifications

Certifications	cULus and CE marked for all applicable directives
Enclosure Rating	IP67 and IP69
Operating Temperature [C (F)]	-20...+55 °C (-4...+131°F)
Operating Voltage	18...30V DC
Status Indicators	LCD display with Green and Red LED backlights
Adjustments	3 push buttons
Output Mode	Programmable light or dark operate
Output Type	PNP or NPN programmable
Response Time	0.3...0.33 ms
Enclosure Material	Zinc die-cast, matt chrome

Required Cordsets and Accessories

Description	Cat. No.
DC Micro (M12) straight QD cordset, 4-pin, 2 m (6.6 ft)	889D-F4AC-2
Mounting bracket	45CRM-BRK1-ADAPT
Point I/O IO-Link Master Module	1734-4IOL
ArmorBlock IO-Link Master	1732E-8IOLM12R
Mounting bracket (L-shaped)	60-BDMS-LS
Micro (M12) shielded QD cordset, 5-pin, 2 m (6.6 ft)	889D-F5EC-2



Photoelectric Sensors

SENSORS

Luminescence 45LUM

- Detects luminescent/fluorescent particles
- 5...50 mm (0.2...2 in.) sensing range
- Teach button setup
- External teach capability
- Rotatable M12 connector
- IP67 rating



Detect What Is Invisible to the Human Eye

The 45LUM luminescence sensor provides a solution for detection of substances which are invisible to the human eye. This sensor detects luminophores or fluorescence, which are emitted from the object being detected. The sensor converts the UV light into a visible light, which is then received by the luminescence sensor. This sensor can detect particles such as glue, clear labels, oils, greases, paint, detergents, and chalks.



Label detection - A 45LUM checks bottles for missing labels.

Photoelectric Sensors



6-2...6-47

Proximity Sensors



6-48...6-77

Ultrasonic Sensors



6-78...6-81

Limit Switches



6-82...6-93

Encoders

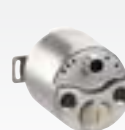

6-94...6-101

Condition Sensing



6-102...6-111

Identification Devices



6-112...6-115

Product Selection

45LUM Luminescence

Sensing Mode	Light Source	Sensing Distance	Spot Size	Cat. No.
Diffuse	Ultraviolet LED	5...50 mm (0.2...2 in.)	3 mm (0.12 in.) at 18 mm (0.71 in.) distance	45LUM-D7JPT1-D5

Sales Offices and Distributors

Our network of sales offices and distributors offers exceptional knowledge and service to help you design, implement and support your automation investment.

<https://rok.auto/buy>



Specifications

Certifications	cULus Listed and CE Marked for all applicable directives
Enclosure Type Rating	IP67
Operating Temperature [C (F)]	-10...+55 ° (+14...+131 °)
Operating Voltage	12...28V DC
Protection Type	Class 2, short circuit and reverse polarity
Supply Current	≤ 40 mA (no load)
Housing Material	ABS
Lens Material	Glass

Required Cordsets and Accessories

Description	Cat. No.
DC Micro (M12) straight QD cordset, 5-pin, 2 m (6.6 ft)	889D-F5AC-2
DC Micro (M12) straight QD cordset, 5-pin, 2 m (6.6 ft)	889D-R5AC-2
Mounting bracket	45BPD-BKT1
Protective mounting bracket	45BPD-BKT2



Photoelectric Sensors

SENSORS

Measuring and Discrete Light Arrays 45MLA and 45DLA

- Detect oddly shaped or non-uniform objects
- Detect targets with gaps or spaces
- Large sensing area
- Discrete (45DLA) and measurement (45MLA) models
- Slim housing profiles
- Sensing range:
 - 45MLA: 4 m
 - 45DLA: 1.5 m or 8 m, selectable via wiring



Traditional photoelectric transmitted beam sensor - single sensing beam



Light array sensor - multiple sensing beams

Light Array Concept

Traditional photoelectric transmitted beam sensors detect in a single line from the emitter to the receiver. Light array sensors combine multiple emitter or receiver elements into a single housing to create a sensing field instead of a single sensing beam. Therefore, light arrays are capable of detecting targets over a wider area. This makes them ideal for detecting oddly shaped parts, products with gaps or spaces, or inconsistently positioned targets, at a fraction of the cost of using multiple sensor pairs.

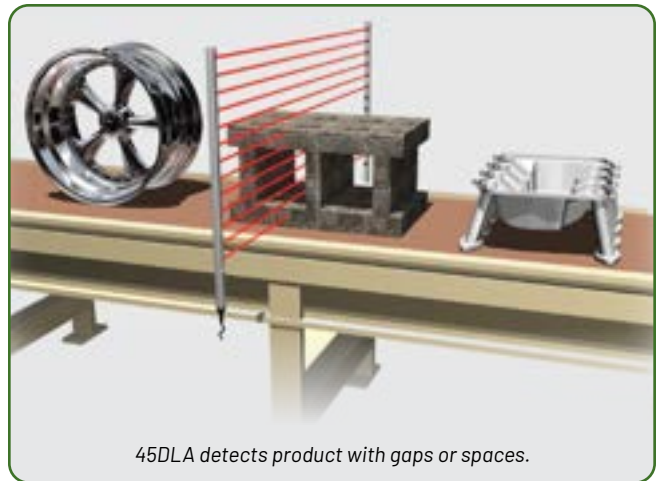

45DLA detects product with gaps or spaces.

Photoelectric Sensors



6-2...6-47

Proximity Sensors



6-48...6-77

Ultrasonic Sensors



6-78...6-81

Limit Switches



6-82...6-93

Encoders



6-94...6-101

Condition Sensing



6-102...6-111

Identification Devices



6-112...6-115

Product Selection – Measuring and Discrete Light Arrays

45MLA Measuring Light Arrays

No. of Beams	Housing Height [mm (in.)]	Sensing Height ¹ [mm (in.)]	Beam Spacing [mm (in.)]	Cat. No.
30	320 (12.6)	300 (11.8)	10 (0.39)	45MLA-AT0300P10
60	630 (24.4)	600 (23.6)	10 (0.39)	45MLA-AT0600P10
90	920 (36.2)	900 (35.4)	10 (0.39)	45MLA-AT0900P10
120	1220 (48)	1200 (47.2)	10 (0.39)	45MLA-AT1200P10
36	920 (36.2)	900 (35.4)	25 (0.98)	45MLA-AT0900P25
48	1220 (48)	1200 (47.2)	25 (0.98)	45MLA-AT1200P25

¹ Sensing heights up to 3 m and ATEX certification available upon request.

45MLA Controllers

Description	Cat. No.
45MLA controller - I/O	45MLA-CTRL
45MLA controller - RS-485	45MLA-CTRL-485
45MLA controller - analog	45MLA-CTRL-ALG
45MLA controller - basic	45MLA-CTRL-BSC
45MLA controller - CAN	45MLA-CTRL-CAN

45DLA Discrete Array

Housing Height [mm (in.)]	Sensing Height [mm (in.)]	Response Time	Sensing Distance [m (ft.)]	Resolution [mm (in.)]	Output	Cat. No.
266 (10.5)	118 (4.65)	25 ms	0.2...8 (0.7...26.2)	30 (1.2)	NPN/PNP	45DLA-1LEB1T-F4
354 (13.9)	206 (8.11)	45 ms	0.2...8 (0.7...26.2)	30 (1.2)	NPN/PNP	45DLA-1LEB2T-F4
530 (20.9)	382 (15.04)	85 ms	0.2...8 (0.7...26.2)	30 (1.2)	NPN/PNP	45DLA-1LEB4T-F4
706 (27.8)	558 (21.97)	125 ms	0.2...8 (0.7...26.2)	30 (1.2)	NPN/PNP	45DLA-1LEB6T-F4
882 (34.7)	734 (28.9)	165 ms	0.2...8 (0.7...26.2)	30 (1.2)	NPN/PNP	45DLA-1LEB8T-F4

Specifications

Certifications	cULus Listed and CE Marked for all applicable directives
Enclosure Type Rating	45MLA and 45DLA: IP54
Operating Temperature [C (F)]	45MLA: 0...+55° (32...131°) 45DLA: -20...+65° (-4...+149°)
Operating Voltage	45MLA: 204...27.6V DC 45DLA: 14...30V DC
Protection Type	Short circuit, reverse polarity, overload
Load Current	100 mA
Housing Material	Aluminum
Lens Material	Polycarbonate

Required Cordsets and Accessories

Description	Cat. No.
Flash mounting kit (two pieces/set)	445L-AF6145
Adjustable 180° bracket kit (two per kit) supplied with each pair. Two kits required per pair	445L-AF6143
180° adjustable flat bracket (two per kit). Two kits required per pair	445L-AF6149
Cable-light array to controller, 3 m patchcord, PVC jacket	445L-AC8RJ3
Cable-light array to controller, 5 m patchcord, M12 to RJ45	445L-AC8RJ5
Cable-light array to controller, 8 m patchcord, PVC jacket	445L-AC8RJ8
Cascadeable array extension patchcord, 1 m (3.28 ft) patchcord (optional)	445L-AC8PC1
Cascadeable array extension patchcord, 3 m (9.8 ft) patchcord (optional)	445L-AC8PC3
DC Micro QD cordset, straight, 4-pin, 2 m (6.5 ft)	889D-F4AC-2
DC Micro QD cordset, straight, 4-pin, 0.3 m (1 ft)	889D-F4AC-5



Photoelectric Sensors

SENSORS

Area and Bin Picking Arrays 45AST and 45PVA

- Specialty light arrays
- Small parts detection (45AST)
- "Pick-to-light" bin picking verification (45PVA)
- Large detection area

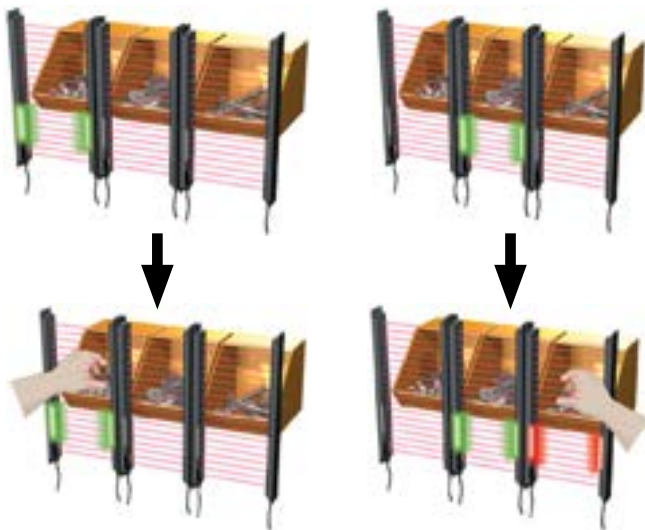

45PVA Parts Verification Array

The 45PVA parts verification array is a special purpose light array for bin picking applications. By mounting the sensors on parts bins and wiring them into a controller programmed with the necessary logic, a virtually error-free bin-picking process can be achieved.

- Bin picking sensors – "pick-to-light" with automatic feedback
- Green "job light" indicates proper bin
- Red "warning indicator" automatically indicates incorrect bin pick
- Reduce risk of missing components or incorrect assembly



Part ejection/counting – A 45AST uses two-dimensional scanning technology to sense an object regardless of its orientation. This is ideal for the detection and counting of parts being ejected from a machine.

Photoelectric Sensors



6-2...6-47

Proximity Sensors



6-48...6-77

Ultrasonic Sensors



6-78...6-81

Limit Switches



6-82...6-93

Encoders

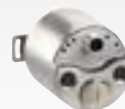

6-94...6-101

Condition Sensing



6-102...6-111

Identification Devices



6-112...6-115

Product Selection

45AST Area and Bin Picking Arrays

Housing Height [mm (in.)]	Sensing Height [mm (in.)]	Response Time	Sensing Distance [m (ft.)]	Resolution [mm (in.)]	Output	Cat. No.
100 (3.9)	50 (2)	4 ms	0.5...2 (1.6...6.5)	15 (0.59)	PNP	45AST-1JPB1-F4
150 (5.9)	100 (3.9)	8 ms	0.15...0.8 (0.5...2.6)	11 (0.43)	PNP	45AST-1JPB2-F4
150 (5.9)	100 (3.9)	8 ms	0.5...2.5 (1.6...8.2)	13 (0.51)	PNP	45AST-1JPB3-F4
200 (7.9)	150 (5.9)	8 ms	0.15...0.8 (0.5...2.6)	17 (0.66)	PNP	45AST-1JPB4-F4

45PVA Parts Verification Arrays

Housing Height [mm (in.)]	Sensing Height [mm (in.)]	Response Time (ms)	Sensing Distance [m (ft.)]	Sensing Mode	Cat. No.
140 (5.5)	100 (3.9)	35 (L.O.), 25 (D.O.)	2 (6.5)	Transmitted beam pair	45PVA-1LEB1-F4
265 (10.4)	225 (8.9)	68 (L.O.), 42 (D.O.)	2 (6.5)	Transmitted beam pair	45PVA-1LEB2-F4
340 (13.4)	300 (11.8)	70 (L.O.), 42 (D.O.)	2 (6.5)	Transmitted beam pair	45PVA-1LEB3-F4
415 (16.3)	375 (14.7)	94 (L.O.), 58 (D.O.)	2 (6.5)	Transmitted beam pair	45PVA-1LEB4-F4
140 (5.5)	100 (3.9)	120	Retro: 2 (6.5); diffuse 0.4 (1.3)	Retroreflective/diffuse	45PVA-2LEA1-F4
265 (10.4)	225 (8.9)	120	Retro: 2 (6.5); diffuse 0.4 (1.3)	Retroreflective/diffuse	45PVA-2LEA2-F4

Specifications

Certifications	cULus Listed and CE Marked for all applicable directives
Enclosure Type Rating	45AST: IP67 45PVA: NEMA 12, IP62
Operating Temperature [C (F)]	45AST: -5...+55 ° (23...131 °) 45PVA: 0...50 ° (32...122 °) for transmitted beam, -10...+50 ° (14...122 °)
Operating Voltage	45AST & 45PVA: 12...24V DC
Protection Type	45AST: Short circuit protection, reverse polarity, false pulse, overload; 45PVA: short circuit protection
Load Current	45AST: 100 mA, max. 45PVA: 50 mA, max.
Housing Material	Aluminum
Lens Material	45AST: Acrylic 45PVA: Polycarbonate

Required Cordsets and Accessories

Description	Cat. No.
DC Micro QD cordset, straight, 4-pin, 2 m (6.5 ft)	889D-F4AC-2
DC Micro QD cordset, straight, 4-pin, 0.3 m (1 ft)	889D-F4AC-5
Mounting bracket used for parts verification array 45PVA	60-2773
Mounting bracket used for parts verification array 45PVA	60-2779
Mounting bracket used for parts verification array 45PVA	60-2772
Protective mounting bracket for 45PVA-1LEB1-F4	60-2775-1
Protective mounting bracket for 45PVA-1LEB2-F4	60-2776-1
Protective mounting bracket for 45PVA-1LEB3-F4	60-2777-1
Protective mounting bracket for 45PVA-1LEB4-F4	60-2778-1
Protective mounting bracket for 45PVA-2LEA1-F4	60-2785-1
Replacement reflective tape roll	92-100



Photoelectric Sensors

SENSORS

Polarized Light Array 45PLA

- 69 mm (2.7 in.) wide sensing area
- 6 mm (0.25 in.) smallest detectable object
- 4.5 m (14.76 ft) maximum sensing range
- Highly visible 360 degree indication LEDs
- IP67 rated



Wide Area Sensing for Material Handling and Packaging Applications

The 45PLA Polarized Light Array is a compact retroreflective array designed to detect irregularly shaped objects in a wide range of industries and applications, notably in the material handling, packaging, food and beverage and lumber industries.

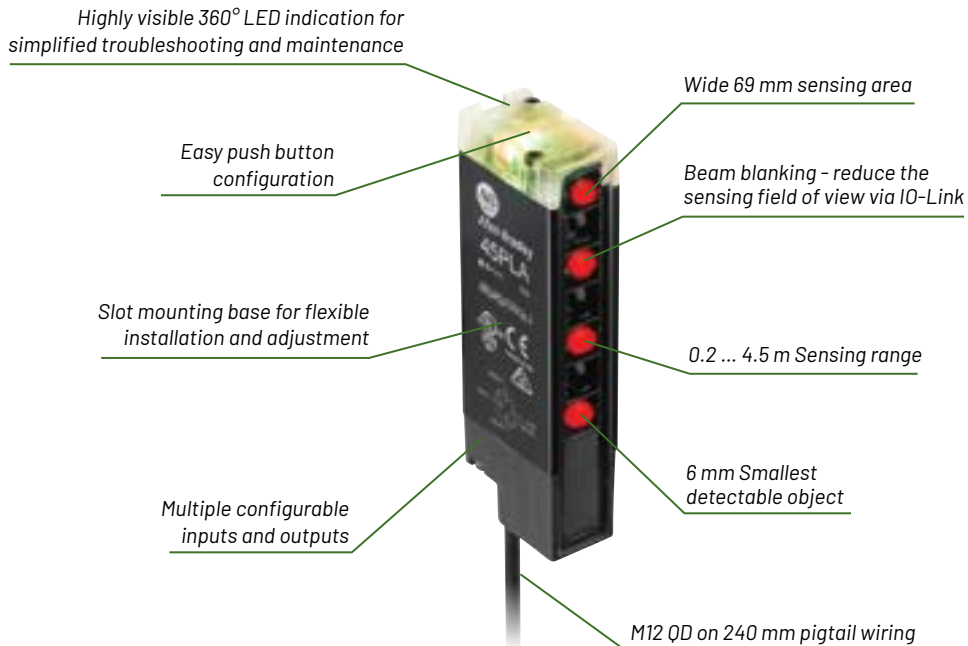

Photoelectric Sensors



6-2...6-47

Proximity Sensors



6-48...6-77

Ultrasonic Sensors



6-78...6-81

Limit Switches



6-82...6-93

Encoders



6-94...6-101

Condition Sensing



6-102...6-111

Identification Devices



6-112...6-115

Product Selection

45PLA Polarized Light Array

Sensing Mode	Light Source	Sensing Distance	Smallest Detection Object	Output Type	Sensitivity Adjustment	Cat. No.
Polarized Retroreflective	Visible red LED	0.15 ... 4.5 m with 92-135 reflector (included)	6 mm	PNP and NPN	One push button	45PLA-P2LPT1-F4 

 IO-Link enabled.

Specifications

Certifications	cULus Listed and CE marked for all applicable directives
Enclosure Type Rating	IP67
Operating Temperature [C (F)]	-10...+55 °C (14...131 °F)
Operating Voltage	12...30V DC
Adjustments	Push button
Output mode	Programmable light or dark operate
Output type	PNP or NPN programmable
Response time	2.5 ms
Cycle time, min	4 ms
Process data bit length	32 bits

Required Cordsets and Accessories

Description	Cat. No.
DC Micro (M12) cordset, 4-pin, 5 m (16.40 ft)	889D-F4AC-5
Replacement mounting kit, with T-shaped insert with four M5 screws	60-BPLA-LS
Mounting bracket, kit of 4 vibration-damping supports	60-BPLA-4V
Replacement retroreflector, PMMA/ABS, 42.1 x 182 mm	92-135



Photoelectric Sensors

SENSORS

Optical Fork 45LSP

- Detects objects as small as 0.2 mm (0.008 in.)
- Highly visible status indication on both sides
- Through-hole, threaded hole, or dovetail mounting
- Gap size up to 120 mm (4.7 in.)
- Remote teach and teach button lock (4-pin models)
- No alignment required
- IP67 rated



Alignment-free Small Part Detection

By eliminating the alignment and adjustment issues associated with other transmitted beam sensing solutions, optical fork sensors are the most easy-to-apply and cost-effective method for small part detection and counting in a wide range of industries.



The range of gap sizes and flexible mounting options make the 45LSP a viable solution for a broad range of applications. In addition to small object detection, these include, but are not limited to, edge detection, parts counting, gear tooth detection, and dimension verification.



Web alignment application - Two 45LSP fork sensors monitor horizontal film position on both sides of the roll. If the film drifts in either direction the sensor's light beam will be interrupted, causing the machine's dancer arm to correct the film position.

Photoelectric Sensors



6-2...6-47

Proximity Sensors



6-48...6-77

Ultrasonic Sensors



6-78...6-81

Limit Switches



6-82...6-93

Encoders



6-94...6-101

Condition Sensing



6-102...6-111

Identification Devices



6-112...6-115

Product Selection

45LSP Optical Fork

Sensing Mode	Light Source	Sensing Gap [mm (in.)]	Sensitivity Adjustment	Output Configuration	Response Time	Cat. No. ¹
Transmitted beam fork	Visible red	30 (1.2)	Teach button	Selectable L.O./D.O., PNP	250 μs	45LSP-2LPA1-P3
			Teach button + remote teach			45LSP-2LPA1-P4
		50 (2)	Push button			45LSP-2LPA2-P3
			Teach button + remote teach			45LSP-2LPA2-P4
		80 (3.2)	Push button			45LSP-2LPA3-P3
			Teach button + remote teach			45LSP-2LPA3-P4
		120 (4.7)	Push button			45LSP-2LPA4-P3
			Teach button + remote teach			45LSP-2LPA4-P4

¹ The **-P3** suffix describes a 3-pin Pico (M8) integral QD and the **-P4** suffix describes a 4-pin Pico (M8) integral QD.



Connected Components
Simpler, faster, cost-effective machine building.
<https://rok.auto/ccw>

Specifications

Certifications	cULus Listed and CE marked for all applicable directives
Enclosure Type Rating	IP67
Operating Temperature [C (F)]	-20...+60 ° (-4...+140 °)
Operating Voltage	10...30V DC
Protection Type	Short circuit, reverse polarity
Load Current	100 mA, max.
Housing Material	Polycarbonate

Required Cordsets and Accessories

Description	Cat. No.
DC Pico QD cordset, straight, 3-pin, 2 m (6.5 ft)	889P-F3AB-2
DC Pico QD cordset, straight, 4-pin, 2 m (6.5 ft)	889P-F4AB-2
Dovetail mounting bracket	44B-BKT

For more information on our complete family of photoelectric products, please visit:
<https://rok.auto/presence-sensing>



Photoelectric Sensors

SENSORS

DIN Rail Fiber Optic Amplifier 46DFA

- ECO display mode reduces power consumption by 25%
- Teachable LED intensity for reliable sensing of clear or transparent objects
- Fast, programmable response speeds
- Push button selectable PNP and NPN output using
- Two high-visibility displays
- Cross-talk protection
- Built-in totalizer



Sensing for Space-critical Applications

Ideal for sensing small objects, fiber optic cables can be mounted in locations that would otherwise be inaccessible to photoelectric sensors. Other characteristics/advantages of fiber optic sensors include:

- Some glass fiber optic tips have the ability to withstand high temperatures [up to 482 °C (900 °F)]
- Withstand extreme shock and vibration
- Often have the fastest response times
- Immunity to electrical interference (EMI, RFI)

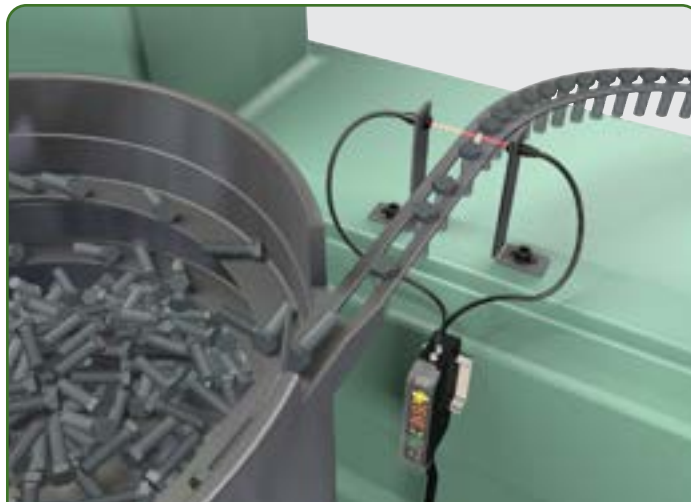

Small part detection - The 46DFA fiber optic ensures continuous flow of small parts exiting from a feeder bowl.

Photoelectric Sensors



6-2...6-47

Proximity Sensors



6-48...6-77

Ultrasonic Sensors



6-78...6-81

Limit Switches



6-82...6-93

Encoders



6-94...6-101

Condition Sensing



6-102...6-111



Identification Devices



6-112...6-115

Product Selection

46DFA DIN Rail Fiber Optic Amplifier

Optical Aperture	Light Source	Sensing Distance	Output Mode	Output Type	Response Time	Connection Type	Catalog Number
2.2 mm	Visible red LED	Depends on fiber optic cable	Programmable complementary light operate and dark operate	Programmable PNP or NPN (both outputs)	Programmable 50 μ s, 500 μ s, 4 ms, 32 ms (500 μ s default)	2 m cable	46DFA-L2LBT1-A2 
						4-pin M12 QD on 150 mm pigtail	46DFA-L2LBT1-F4 

 IO-Link enabled.

Specifications

Certifications	cULus and CE marked for all applicable directives
Status indicators	Dual display, output and operation LEDs
Adjustments	Push buttons
Sensing range	Depends on fiber optic cable
Light source	Visible red LED 660 nm
Operating voltage	12...24V DC
Sensor protection	Reverse polarity and short circuit protection
Output type	Pin 4: PNP or NPN Pin 2: PNP or NPN
Output mode	Programmable light operate and dark operate
Response time	50 μ s, 500 μ s (Default), 4 ms, 32 ms
Load current	100 mA max
Housing Material	Polycarbonate
Enclosure Rating	IP40
Operating Temperature	1 to 5 adjacent sensors: -25...+55 °C (14...131 °F) 6 or more adjacent sensors: -25...+50 °C (14...122 °F)
Connections	2 m cable 4-pin M12 QD on 150 mm pigtail

Required Cordsets and Accessories

Description	Catalog Number
4-pin DC Micro (M12) Cordset, 5 m length	889D-F4AC-5
Mounting bracket, DIN rail stop	60-BDFA-STP
Mounting bracket, 46DFA DIN rail single mount	60-BDFA-DIN

Go to www.ab.com to see the full line of 46DFA DIN Rail Fiber Optic Amplifier sensors and accessories.



Photoelectric Sensors

SENSORS

Fiber Optic Cables

Plastic

- Best used with visible light sources
- High flex applications
- Cost effective

Glass

- Suitable for visible or infrared light source
- High temperature applications
- Chemically resistant



Product Selection – Fiber Optic Cables

Fiber Optic Cables for Use with These Large Aperture Sensors:

- Series 9000 42GxF-900x
- RightSight 42EF-G1xxA

Description	Sensing Tip Material	Fiber Bundle Diameter [mm (in.)]	Sheathing Material	Nominal Sensing Ref. [mm (in.)]	Cat No.
Bifurcated Cables for Large Aperture Sensors [4.6 mm/0.187 in.]¹					
Threaded 5/16 in. straight tip	Brass	-	PVC	120 (4.75)	43GR-TBB25ML
Threaded 5/16 in. straight tip	Brass	-	Stainless steel	120 (4.75)	43GR-TBB25SL
Right angle tip with 5/16 in. x 24 thread	Stainless steel	-	PVC	120 (4.75)	43GR-TMS25ML
Right angle tip with 5/16 in. x 24 thread	Brass/Stainless steel	-	Stainless steel	120 (4.75)	43GR-TMC25SL
Ferrule (smooth) right angle tip	Stainless steel	-	PVC	120 (4.75)	43GR-FIS25ML
Ferrule (smooth) right angle tip	Stainless steel	-	Stainless steel	120 (4.75)	43GR-FIS25SL
Transmitted Beam Cables for Large Aperture Sensors [4.6 mm/0.187 in.]²					
Threaded 5/16 in. straight tip	Brass	-	PVC	508 (20)	43GT-TBB25ML
Threaded 5/16 in. straight tip	Brass	-	Stainless steel	508 (20)	43GT-TBB25SL
Threaded 5/16 in. with right angle tip	Brass	-	PVC	508 (20)	43GT-TQS25ML
Threaded 5/16 in. with right angle tip	Brass	-	Stainless steel	508 (20)	43GT-TQS25SL
Right angle tip with 5/16 in. x 24 thread	Stainless steel	-	PVC	508 (20)	43GT-TMS25ML
Right angle tip with 5/16 in. x 24 thread	Brass/Stainless steel	-	Stainless steel	508 (20)	43GT-TMC25SL
Ferrule (smooth) right angle tip	Stainless steel	-	PVC	508 (20)	43GT-FIS25ML
Ferrule (smooth) right angle tip	Stainless steel	-	Stainless steel	508 (20)	43GT-FIS25SSL

Photoelectric Sensors



6-2...6-47

Proximity Sensors



6-48...6-77

Ultrasonic Sensors



6-78...6-81

Limit Switches



6-82...6-93

Encoders



6-94...6-101

Condition Sensing



6-102...6-111

Identification Devices



6-112...6-115

Product Selection

1. Select Fiber

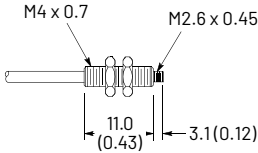
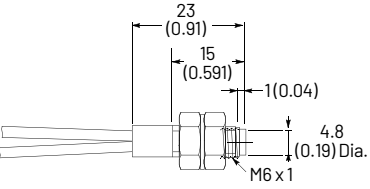
Approximate Dimensions [mm (in.)]	Bend Radius [mm (in.)]	Fiber Bundle Diameter [mm (in.)]	Sheathing Material	Catalog Number
Threaded Transmitted Beam Cables for Small Aperture Sensors [2.2 mm (0.09 in.)]				
	25 (1.0)	1 (0.04)	Polyethylene	43PT-NJS56FS
Threaded Bifurcated Cables (Diffuse) for Small Aperture Sensors [2.2 mm (0.09 in.)]				
	40 (1.6)	2 x 1.5 (0.06)	Polyethylene	43PR-NDS59FS

Note: Visit Proposal Works (<https://rok.auto/configure>) for complete fiber selection.

2. Select Amplifier

Optical Aperture	Light Source	Sensing Distance	Output Mode	Output Type	Response Time	Connection Type	Catalog Number
2.2 mm	Visible red LED	Depends on fiber optic cable	Programmable complementary light operate and dark operate	Programmable PNP or NPN (both outputs)	Programmable 50 μ s, 500 μ s, 4 ms, 32 ms (500 μ s default)	2 m cable	46DFA-L2LBT1-A2
						4-pin M12 QD on 150 mm pigtail	46DFA-L2LBT1-F4





Proximity Sensors

Sensor Selection

Inductive proximity sensors provide non-contact detection of metal objects across relatively short distances (up to 2.5 inches or 65 mm). Sensor size, along with whether the sensor has shielded (flush-mountable) or unshielded (non flush-mountable) construction, dictates sensing range. Other factors/ functions to consider include output and connection type, environmental protection rating, power requirements and proximity to electrical fields (i.e. weld field immunity).

Allen-Bradley® inductive proximity sensors set the standard for ruggedness, reliability and application flexibility. We offer one of the industry's widest sensor offerings serving the full spectrum of your needs, from light-duty packaging applications to the punishing environments on automotive welding equipment or the harsh washdowns in food processing plants. Below is a quick selection guide for our most popular products - to see our complete line of sensors, go to <https://rok.auto/sensors-switches>.

Inductive Sensors

	Application	Housing Diameter/ Dimensions (mm)	Sensing Range Shielded (mm)	Sensing Range Unshielded (mm)	Enclosure Ratings	2-wire DC	3-wire DC	4-wire DC	2-wire AC	2-wire AC/DC
 <p>872 WorldProx</p>	General Purpose	6.5	2 & 3	3	IP67	✓	✓	✓	✓	✓
		8	2 & 3	3, 4, 6						
		12	3, 4, 6	4, 8, 10						
		18	5, 8, 12	8, 12, 20						
		30	10, 15, 22	15, 20, 40						
 <p>871TM</p>	Harsh Duty/ Welding	8	3	6	All units IP67 & 1200 psi wash down rated (Selected units meet IP69K)	✓	✓		✓	✓
		12	2 & 6	4 & 10						
		18	5 & 10	8 & 20						
		30	10 & 20	15 & 40						
 <p>871TS</p>	Food & Beverage	12	4	4 & 8	IP67, IP68 & IP69K		✓			
		18	8	8 & 12						

Photoelectric Sensors



6-2...6-47

Proximity Sensors



6-48...6-77

Ultrasonic Sensors



6-78...6-81

Limit Switches



6-82...6-93

Encoders



6-94...6-101

Condition Sensing



6-102...6-111

Identification Devices



6-112...6-115

Inductive Sensors

	Application	Housing Diameter/Dimensions (mm)	Sensing Range Shielded (mm)	Sensing Range Unshielded (mm)	Enclosure Ratings	2-wire DC	3-wire DC	4-wire DC	2-wire AC	2-wire AC/DC
871Z 	Welding	12	2	4	IP67		✓			✓
		18	5	8						
		30	10	15						
871ZT 	Welding	12	3	8	IP67		✓			
		18	5	12						
		30	10	20						
871 VersaCube 	Material Handling & Welding	40 x 40	20	40	All units IP67 & 1200 psi wash down rated (Selected units meet IP69K)			✓		✓
		40 x 40 WFI	15 & 20	25 & 40						
871F Flat Pack 	Material Handling & Welding	80 x 80	50	65	All units IP67 & 1200 psi wash down rated (Selected units meet IP69K)		✓			✓
		80 x 80 WFI	40	50						
871C Miniature Tubular 	Automated Assembly & Robotics	3 smooth barrel	0.6 & 1	NA	IP67		✓			
		4 smooth barrel	0.6 & 1	NA						
		4	0.8 & 1.5	NA						
		5	1 & 1.5	NA						
871FM Miniature Rectangular 	Automated Assembly, Robotics & Welding (Select Products)	5 x 5	0.8 & 1.5	NA	IP67		✓			
		8 x 8	2	3						
		26 x 16 x 11	2	NA						
		20 x 32 x 8	NA	7	IP67 or IP69K			✓		
		30 x 52 x 14	NA	10						



Proximity Sensors

SENSORS

Miniature 871C

- Miniature housings for space-critical applications
- Extended sensing range
- Stainless steel housing
- Quick disconnect and cable options
- Fully integrated electronics



Miniature Sensors for Industrial Automation

Our miniature inductive sensors were designed to meet the needs of today's compact machines. With limited space on these machines, mounting space for sensors is limited. Allen-Bradley 871C sensors were developed to meet this design requirement while providing superior performance, including longer sensing range. Longer sensing ranges allow our sensors to be mounted further away from the target reducing the risk of mechanical contact.

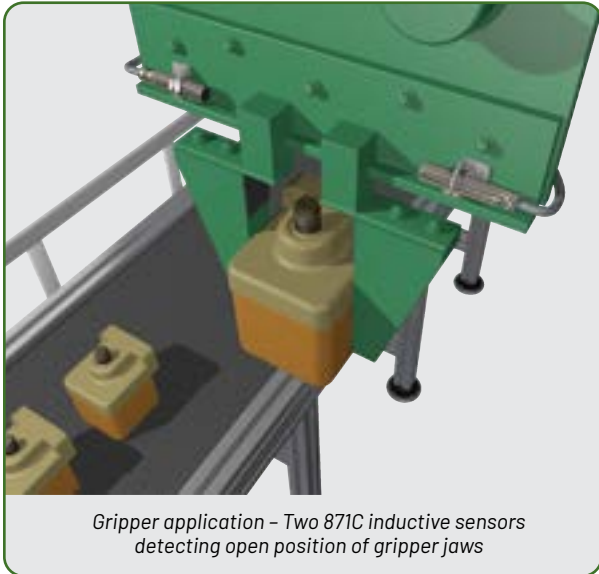

Gripper application - Two 871C inductive sensors detecting open position of gripper jaws

These small-barrel sensors are designed for space-critical applications where standard size sensors simply won't fit.

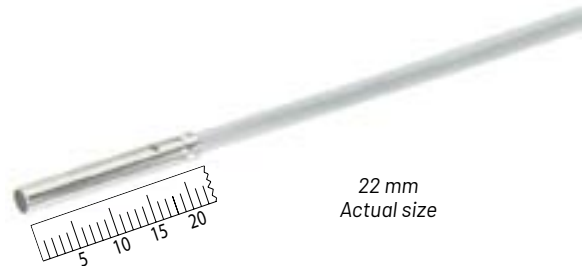

22 mm
Actual size

6-50

Photoelectric Sensors



6-2...6-47

Proximity Sensors



6-48...6-77

Ultrasonic Sensors



6-78...6-81

Limit Switches



6-82...6-93

Encoders



6-94...6-101

Condition Sensing



6-102...6-111







Identification Devices



6-112...6-115

Product Selection

3-wire DC

Barrel Diameter	Nominal Sensing Distance [mm (in.)]	Shielded	Output Configuration	Switching Frequency [Hz]	Housing Length [mm (in.)]	Thread Length [mm (in.)]	Connection Type	Cat. No.
3 mm, smooth	1 (0.04)	Yes	N.O., PNP	3000	22 (0.87)	-	2 m cable	871C-MM1NP3-E2 
4 mm, threaded						-	6 in. Pico QD pigtail	871C-MM1NP3-AP3 
	19 (0.74)					2 m cable	871C-M1NP4-E2 	
6 in. Pico QD pigtail						871C-M1NP4-AP3 		
4 mm, smooth	1.5 (0.06)				25 (0.98)	-	2 m cable	871C-MM2NP4-E2 
						38 (1.50)	Pico QD	871C-MM2NP4-P3 
5 mm, threaded					25 (0.98)	20 (0.79)	2 m cable	871C-M2NP5-E2 
						38 (1.50)	23 (0.90)	Pico QD

 IO-Link enabled.

Specifications

Certifications	UL Listed and CE Marked for all applicable directives
Enclosure Type Rating	NEMA 1, 2, 3, 4, 12, 13; IP67 (cable only), IP65 (QD only) (IEC 529)
Operating Temperature [C (F)]	-25...+70 ° (-13...+158 °)
Operating Voltage	10...30V DC
Protection Type	False pulse, transient noise, reverse polarity, short circuit
Load Current	3 mm smooth and 4 mm threaded barrel: ≤100 mA 4 mm smooth and 5 mm threaded barrel: ≤200 mA
Housing Material	Stainless steel barrel, polyester face

Required Cordsets and Accessories

Description	Cat. No.
DC Pico QD cordset, straight, 3-pin, 2 m (6.5 ft)	889P-F3AB-2
Clamp style bracket, 4 mm (0.16 in.)	871-BP4
Clamp style bracket, 5 mm (0.2 in.)	871-BP5
Point I/O IO-Link Master Module	1734-4IOL
ArmorBlock IO-Link Master	1732E-8IOLM12R



Proximity Sensors

SENSORS

WorldProx™ 872C

- General purpose
- Wide range of options
- Standard, extended and long range
- Extended range and long range models offer up to three times standard sensing range
- Multiple connection styles



An Extended Range, General Purpose Solution

The most common cause of sensor failure is contact with the intended target. Sensors with longer range can be used to eliminate/limit contact with the target, thus reducing the cost associated with replacing damaged sensors (due to the cost of the sensor, maintenance time, and lost production).

Additionally, increased sensing range allows machine manufacturers to use smaller sensors and save space on the machine or to locate the sensors in previously inaccessible areas.

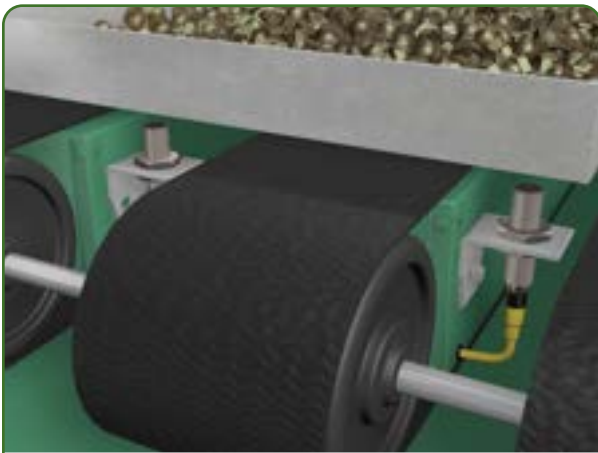

Conveyor application - Two 872C WorldProx sensors detecting presence of a part bin on a conveyor belt

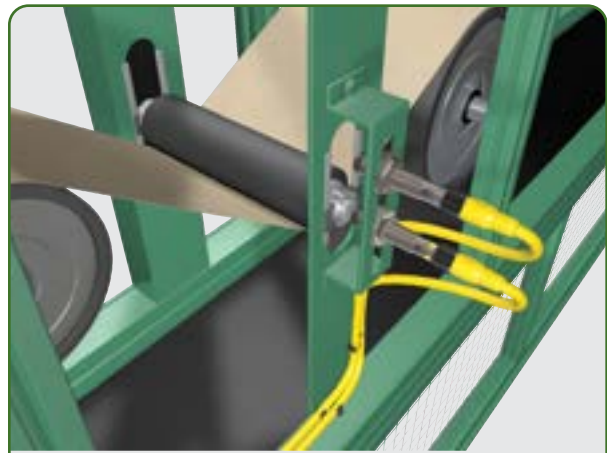

Paper tension - A pair of WorldProx sensors detecting the tension roller position for speed control

Photoelectric
Sensors



6-2...6-47

Proximity
Sensors



6-48...6-77

Ultrasonic
Sensors



6-78...6-81

Limit
Switches



6-82...6-93

Encoders



6-94...6-101

Condition
Sensing



6-102...6-111

Identification
Devices



6-112...6-115

Product Selection

3-Wire DC Standard Barrel

Barrel Diameter	Nominal Sensing Distance [mm (in.)]	Shielded	Output Configuration	Switching Frequency [Hz]	Housing Length [mm (in.)]	Thread Length [mm (in.)]	Connection Type ¹	Cat. No.			
6.5 mm, smooth	3 (0.12)	Yes	N.O./PNP	1,000	66.0 (2.59)	-	Micro QD	872C-M3NP7-D4			
8 mm	2 (0.08)	Yes		2500	500	55 (2.17)		30 (1.18)	872C-D2NP8-D4 ^{2,3}		
	3 (0.12)	No				60 (3.62)			872C-D3NP8-D4 ^{2,3}		
	3 (0.12)	Yes				55 (2.17)			872C-M3NP8-D4 ^{2,3}		
	4 (0.16)	No				60 (3.62)			872C-N4NP8-D4 ^{2,3}		
	6 (0.23)	No				500			66.0 (2.59)	40.0 (1.57)	872C-N6NP8-D4
12 mm	3 (0.12)	Yes		1300	800	64.3 (2.53)		38.1 (1.50)	872C-D3NP12-D4		
	4 (0.16)	No				72.4 (2.85)			872C-D4NP12-D4		
	4 (0.16)	Yes				64.3 (2.53)			872C-M4NP12-D4		
	8 (0.31)	No				70 (2.76)			872C-N8NP12-D4		
	6 (0.23)	Yes				800			60.0 (2.36)	40.0 (1.57)	872C-M6NP12-D4
	10 (0.39)	No				400			60.0 (2.36)	872C-N10NP12-D4	
18 mm	5 (0.2)	Yes		1500	500	65.5 (2.58)		38.1 (1.50)	872C-D5NP18-D4		
	8 (0.31)	No				75.5 (2.97)			872C-D8NP18-D4		
	8 (0.31)	Yes				75 (2.95)			872C-M8NP18-D4		
	12 (0.47)	No				1000			75.5 (2.97)	872C-M12NP18-D4	
	12 (0.47)	Yes				500			65.5 (2.58)	38.1 (1.50)	872C-M12NP18-D4
	20 (0.79)	No				200			63.5 (2.5)	32.0 (1.25)	872C-N20NP18-D4
	10 (0.39)	Yes				1000			64.3 (2.53)	48.3 (1.90)	872C-D10NP30-D4
30 mm	15 (0.59)	No		100	1000	76.5 (3.01)		42.5 (1.67)	872C-D15NP30-D4		
	15 (0.59)	Yes				64.3 (2.53)			48.3 (1.90)	872C-M15NP30-D4	
	20 (0.79)	No				76.5 (3.01)			42.5 (1.67)	872C-N20NP30-D4	
	22 (0.86)	Yes				200			73.5 (2.89)	52.0 (2.04)	872C-M22NP30-D4
	40 (1.57)	No				100			73.5 (2.89)	42.0 (1.65)	872C-N40NP30-D4

Specifications

Certifications	cULus Listed and CE Marked for all applicable directives
Enclosure Type Rating	IP67 (IEC 529)
Operating Temperature [C (F)]	-25...+70 ° (-13...+158 °)
Operating Voltage	10...30V DC
Protection Type	False pulse on power, transient noise, reverse polarity, short circuit, overload
Load Current	≤ 200 mA
Housing Material	Nickel-plated brass barrel, plastic face (PBT)

¹ For additional connection types, please visit <https://rok.auto/directory>.

² Operating Voltage: 5...30 VDC

³ Load Current: ≤ 100 mA

Required Cordsets and Accessories

Description	Cat. No.
DC Micro (M12) QD cordset, straight, 4-pin, 2 m (6.5 ft)	889D-F4AC-2
Right angle mounting bracket	871A-BRN ⁴
Snap clamp mounting bracket	871A-SCPB ⁵

⁴ Add **8**, **12**, **18**, or **30** to the end of the catalog number for sensor barrel diameter in mm.

⁵ Add **12** or **18** to the end of the catalog number for sensor barrel diameter in mm.

For more information on our complete family of inductive proximity products, please visit:
<https://rok.auto/presence-sensing>



Proximity Sensors

Product Selection

3-Wire DC Short Barrel

Barrel Diameter	Nominal Sensing Distance [mm (in.)]	Shielded	Output Configuration	Switching Frequency [Hz]	Housing Length [mm (in.)]	Thread Length [mm (in.)]	Connection Type ¹	Cat. No.
8 mm	2 (0.08)	Yes	N.O./PNP	2500	45.2 (1.78)	20.1 (0.79)	Micro QD	872C-DH2NP8-D4 ^{2,3}
	3 (0.12)	No			50 (1.97)			872C-DH3NP8-D4 ^{2,3}
	3 (0.12)	Yes			45.2 (1.78)			872C-MH3NP8-D4 ^{2,3}
	4 (0.16)	No			50 (1.97)			872C-NH4NP8-D4 ^{2,3}
12 mm	3 (0.12)	Yes		1300	48.3 (1.90)	27.4 (1.08)		872C-DH3NP12-D4
	4 (0.16)	No			56.3 (2.22)			872C-DH4NP12-D4
	4 (0.16)	Yes			48.3 (1.90)			872C-MH4NP12-D4
	8 (0.32)	No			56.3 (2.22)			872C-NH8NP12-D4
18 mm	5 (0.20)	Yes		1500	49.5 (1.95)	26.4 (1.04)		872C-DH5NP18-D4
	8 (0.31)	No			59.5 (2.34)			872C-DH8NP18-D4
	8 (0.32)	Yes			49.5 (1.95)			872C-MH8NP18-D4
	12 (0.47)	No			59.5 (2.34)			872C-NH12NP18-D4
30 mm	15 (0.59)	No	1000	63.2 (2.49)	29.2 (1.15)	872C-DH15NP30-D4		
	15 (0.59)	Yes		50.8 (2.00)	31.8 (1.25)	872C-MH15NP30-D4		
	20 (0.79)	No		63.2 (2.49)	29.2 (1.15)	872C-NH20NP30-D4		

¹ For additional connection types, please visit <https://rok.auto/directory>.

² Operating Voltage: 5...30 VDC

³ Load Current: ≤ 100 mA

Specifications

Certifications	cULus Listed and CE Marked for all applicable directives
Enclosure Type Rating	NEMA 1, 2, 3, 4, 6P, 12, 13, IP67 (IEC 529)
Operating Temperature [C (F)]	-25...+70 ° (-13...+158 °)
Operating Voltage	10...30V DC
Protection Type	False pulse on power, transient noise, reverse polarity, short circuit, overload
Load Current	≤ 200 mA
Housing Material	Nickel-plated brass barrel, plastic face (PBT)

Required Cordsets and Accessories

Description	Cat. No.
DC Micro QD cordset, straight, 4-pin, 2 m (6.5 ft)	889D-F4AC-2
Right angle mounting bracket	871A-BRN ⁴
Snap clamp mounting bracket	871A-SCP ⁵

⁴ Add **8**, **12**, **18**, or **30** to the end of the catalog number for sensor barrel diameter in mm.

⁵ Add **12** or **18** to the end of the catalog number for sensor barrel diameter in mm.

Photoelectric Sensors



6-2...6-47

Proximity Sensors



6-48...6-77

Ultrasonic Sensors



6-78...6-81

Limit Switches



6-82...6-93

Encoders



6-94...6-101

Condition Sensing



6-102...6-111

Identification Devices



6-112...6-115

Product Selection

2-Wire DC

Barrel Diameter	Nominal Sensing Distance [mm (in.)]	Shielded	Output Configuration	Switching Frequency [Hz]	Housing Length [mm (in.)]	Thread Length [mm (in.)]	Connection Type ¹	Cat. No.
12 mm	3 (0.12)	Y	N.O.	2000	65.0 (2.56)	38.1 (1.50)	Micro QD	872C-D3NE12-D4
	4 (0.16)	N			72.4 (2.85)			872C-D4NE12-D4
18 mm	5 (0.20)	Y		1000	65.0 (2.56)			872C-D5NE18-D4
	8 (0.31)	N			76.5 (3.01)	872C-D8NE18-D4		
30 mm	10 (0.39)	Y		500	65.0 (2.56)	46.7 (1.84)		872C-D10NE30-D4
	15 (0.59)	N			76.5 (3.01)			872C-D15NE30-D4

¹ For additional connection types, please visit <https://rok.auto/directory>.

Sales Offices and Distributors

Our network of sales offices and distributors offers exceptional knowledge and service to help you design, implement and support your automation investment.

<https://rok.auto/buy>



Specifications

Certifications	cULus Listed and CE Marked for all applicable directives
Enclosure Type Rating	NEMA 1, 2, 3, 4, 6P, 12, 13, IP67 (IEC 529)
Operating Temperature [C (F)]	-25...+70 ° (-13...+158 °)
Operating Voltage	10...30V DC
Protection Type	False pulse on power, transient noise, reverse polarity, overload
Load Current	≤100 mA
Housing Material	Nickel-plated brass barrel, plastic face (PBT)

Required Cordsets and Accessories

Description	Cat. No.
DC Micro (M12) QD cordset, straight, 4-pin, 2 m (6.5 ft)	889D-F4AC-2
Right angle mounting bracket	871A-BRN ²
Snap clamp mounting bracket	871A-SCPB ³

² Add **8**, **12**, **18**, or **30** to the end of the catalog number for sensor barrel diameter in mm.

³ Add **12** or **18** to the end of the catalog number for sensor barrel diameter in mm.



Proximity Sensors

Product Selection

2-Wire AC

Barrel Diameter	Nominal Sensing Distance [mm (in.)]	Shielded	Output Configuration	Switching Frequency (Hz)	Housing Length [mm (in.)]	Thread Length [mm (in.)]	Connection Type ¹	Cat. No.
12 mm	2 (0.08)	Y	N.O.	15	75.0 (2.95)	45.0 (1.77)	Micro QD	872C-A2N12-R3
	4 (0.16)			20				872C-F4N12-R3
	4 (0.16)	N		15		40.0 (1.57)		872C-A4N12-R3
	8 (0.31)			20				872C-G8N12-R3
18 mm	5 (0.20)	Y		15	80.0 (3.15)	60.0 (2.36)		872C-A5N18-R3
	8 (0.31)			20				872C-F8N18-R3
	10 (0.39)	N		15		52.0 (2.05)		872C-A10N18-R3
	12 (0.47)			20				872C-G12N18-R3
30 mm	10 (0.39)	Y	15	80.0 (3.15)	50.0 (1.96)	872C-A10N30-R3		
	15 (0.59)		20			872C-F15N30-R3		
	15 (0.59)	N	15		38.0 (1.50)	872C-A15N30-R3		
	30 (1.18)		20			872C-G30N30-R3		

¹ For additional connection types, please visit <https://rok.auto/directory>.

Specifications

Certifications	cULus Listed and CE Marked for all applicable directives
Enclosure Type Rating	NEMA 1, 2, 3, 4, 6P, 12, 13, IP67 (IEC 529)
Operating Temperature [C (F)]	-25...+70 ° (-13...+158 °)
Operating Voltage	20...250V AC
Protection Type	False pulse on power, transient noise
Load Current	≤300 mA
Housing Material	Nickel-plated brass barrel, plastic face (PBT)

Required Cordsets and Accessories

Description	Cat. No.
AC Micro (M12) QD cordset, straight, 3-pin, 2 m (6.5 ft)	889R-F3ECA-2
Right angle mounting bracket	871A-BRN ²
Snap clamp mounting bracket	871A-SCPB ³

² Add **12**, **18**, or **30** to the end of the catalog number for sensor barrel diameter in mm.

³ Add **12** or **18** to the end of the catalog number for sensor barrel diameter in mm.

Photoelectric Sensors



6-2...6-47

Proximity Sensors



6-48...6-77

Ultrasonic Sensors



6-78...6-81

Limit Switches



6-82...6-93

Encoders



6-94...6-101

Condition Sensing



6-102...6-111

Identification Devices



6-112...6-115

Product Selection

2-Wire AC/DC

Barrel Diameter	Nominal Sensing Distance [mm (in.)]	Shielded	Output Configuration	Switching Frequency (Hz)	Housing Length [mm (in.)]	Thread Length [mm (in.)]	Connection Type ¹	Cat. No.
12 mm	2 (0.08)	Y	N.O.	30	75.0 (2.95)	45.0 (1.77)	Micro QD	872C-J2N12-R3
	4 (0.16)	N				40.0 (1.57)		872C-K4N12-R3
18 mm	5 (0.20)	Y			80.0 (3.15)	60.0 (2.36)		872C-J5N18-R3
	8 (0.31)	N				52.0 (2.05)		872C-K8N18-R3
30 mm	10 (0.39)	Y			80.0 (3.15)	50.0 (1.96)		872C-J10N30-R3
	15 (0.59)	N				38.0 (1.50)		872C-K15N30-R3

¹ For additional connection types, please visit <https://rok.auto/directory>.



Product Selection Tools

Available online or for download, our tools help you access info while in the office or on the go.

<https://rok.auto/selection>

Specifications

Certifications	cULus Listed and CE Marked for all applicable directives
Enclosure Type Rating	NEMA 1, 2, 3, 4, 6P, 12, 13, IP67 (IEC 529)
Operating Temperature [C (F)]	-25...+70 ° (-13...+158 °)
Operating Voltage	20...250V AC/DC
Protection Type	False pulse on power, transient noise, short circuit, overload
Load Current	≤300 mA for 12 mm units, and ≤350 mA for 18 and 30 mm units
Housing Material	Nickel-plated brass barrel, plastic face (PBT)

Required Cordsets and Accessories

Description	Cat. No.
AC Micro (M12) QD cordset, straight, 3-pin, 2 m (6.5 ft)	889R-F3ECA-2
Right angle mounting bracket	871A-BRN ²
Snap clamp mounting bracket	871A-SCPB ³

² Add **12**, **18**, or **30** to the end of the catalog number for sensor barrel diameter in mm.

³ Add **12** or **18** to the end of the catalog number for sensor barrel diameter in mm.

For more information on our complete family of inductive proximity products, please visit:
<https://rok.auto/presence-sensing>



Proximity Sensors

SENSORS

Stainless Steel – Weld Field Immune 871TM

- Heavy duty stainless steel face and barrel
- IP69K and 1200 psi washdown rated
- Chemical and abrasion resistant
- Long range models offer equal sensing distance for all metals
- Long range weld field immune up to 40mT (select models)
- IO-Link enabled (select models)



For Your Toughest Applications

The 871TM stainless steel sensors are ideal for harsh or extremely demanding environments. These sensors resist impact, abrasion and corrosion – to keep things moving where ordinary sensors grind to a halt. This line features full mechanical seals at all barrel openings and full epoxy encapsulation for optimal performance in the toughest environments.

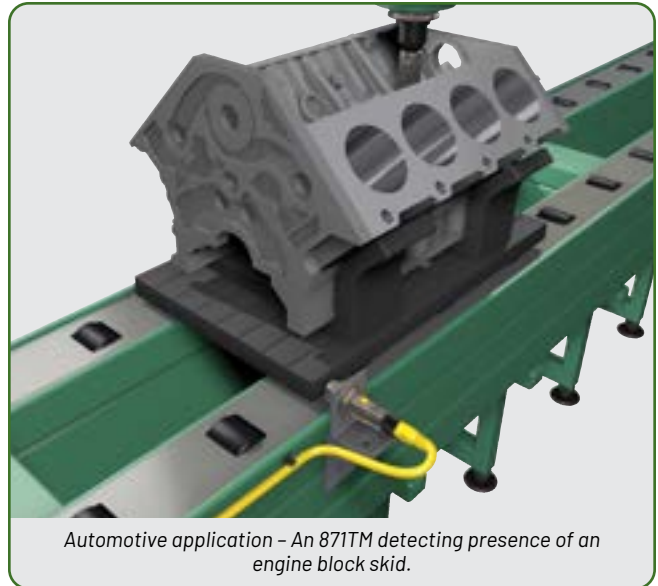
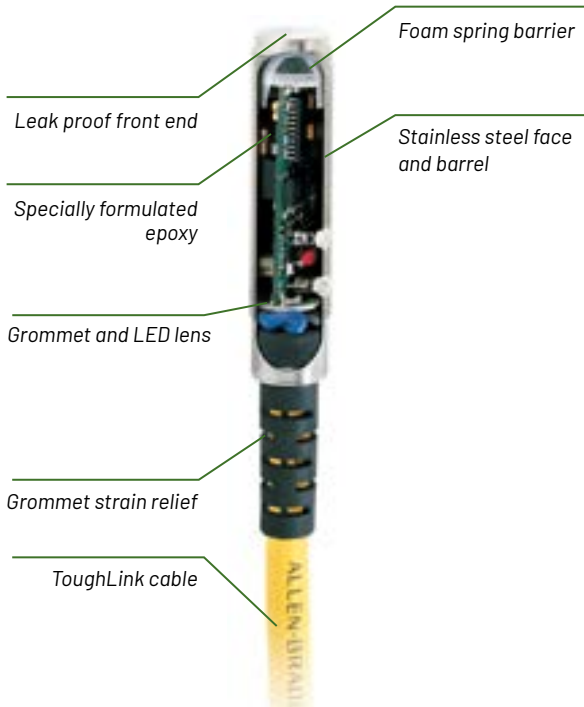

Welding Applications

Select weld field immune models are ideal for welding environments and other applications where strong magnetic fields are present.

Photoelectric Sensors



6-2...6-47

Proximity Sensors



6-48...6-77

Ultrasonic Sensors



6-78...6-81

Limit Switches



6-82...6-93

Encoders



6-94...6-101

Condition Sensing



6-102...6-111

Identification Devices



6-112...6-115

Product Selection

3-Wire DC (weld field immune select models)

Barrel Diameter	Nominal Sensing Distance [mm (in.)]	Shielded	Weld Field Immune	Output Configuration	Switching Frequency [Hz]	Housing Length [mm (in.)]	Thread Length [mm (in.)]	Connection Type	Cat. No.
8 mm	3 (0.12)	Yes	No	N.O./PNP	700	66 (2.59)	46 (1.81)	Micro QD	871TM-M3NP8-D4
	3 (0.12)	Yes	Yes		400	60 (2.36)	45 (1.77)	Pico QD	871TM-MW3NP8-P3
	6 (0.23)	No	No		700	66 (2.59)	42 (1.65)	Micro QD	871TM-N6NP8-D4
12 mm	2 (0.08)	Yes	No		75	61 (2.40)	26.4 (1.04)		871TM-DH2NP12-D4
	6 (0.23)		Yes		400	60 (2.36)	41 (1.61)		871TM-M6NP12-D4
	6 (0.23)	No	Yes		400	60 (2.36)	41 (1.61)		871TM-MW6NP12-D4
	4 (0.16)		No		70	61 (2.40)	28 (1.10)		871TM-DH4NP12-D4
18 mm	10 (0.39)	Yes	No		400	60 (2.36)	36 (1.42)		871TM-N10NP12-D4
	10 (0.39)		Yes		60	65 (2.55)	41.7 (1.64)		871TM-DH5NP18-D4
	10 (0.39)		No		200	63.5 (2.5)	42.5 (1.67)		871TM-M10NP18-D4
	8 (0.31)	No	No		400	63.5 (2.5)	42.5 (1.67)		871TM-MW10NP18-D4
	20 (0.79)		Yes		40	65 (2.55)	41.7 (1.64)		871TM-DH8NP18-D4
30 mm	10 (0.39)	Yes	No		200	63.5 (2.5)	35.5 (1.40)	871TM-N20NP18-D4	
	20 (0.79)				40	66.3 (2.61)	41.9 (1.65)	871TM-DH10NP30-D4	
	15 (0.59)	No			80	63.5 (2.5)	42.5 (1.67)	871TM-M20NP30-D4	
	40 (1.57)				30	66.3 (2.61)	39.4 (1.55)	871TM-DH15NP30-D4	
					80	63.5 (2.5)	35.5 (1.40)	871TM-N40NP30-D4	

IO-Link enabled.

Specifications

Certifications	CE Marked for all applicable directives (standard range models also UL Listed and CSA Certified), long range also cULus Listed)
Enclosure Type Rating	NEMA 1, 2, 3, 3R, 4, 4X, 6, 6P, 12, 13; IP67 (IEC 529) all models; 1200 psi (8270 kPa) washdown; standard range Micro connector versions are also rated IP69K (IEC 529) except for 8 mm versions
Operating Temperature [C (F)]	Operating Temperature Range: 871TM-DH -25 to 70 °C (-13 to 158 °F) 871TM-M and 871TM-N -25 to 85 °C (-13 to 185 °F)
Operating Voltage	10...30V DC
Protection Type	False pulse, transient noise, reverse polarity, short-circuit (trigger at 340 mA typical), overload
Load Current	≤200 mA
Leakage Current, Max.	≤10 mA on standard range models, ≤0.1 mA on extended range models
Housing Material	Stainless steel face and barrel

Required Cordsets and Accessories

Description	Cat. No.
DC Micro (M12) QD cordset, straight, 4-pin, 2 m (6.5 ft)	889D-F4AC-2
DC Pico QD cordset, straight, 3-pin, 2 m (6.5 ft)	889P-F3AB-2
Right angle mounting bracket	871A-BRN ¹
Snap clamp mounting bracket	871A-SCPB ²
Point I/O IO-Link Master Module	1734-4IOL
ArmorBlock IO-Link Master	1732E-8IOLM12R

¹ Add **8**, **12**, **18**, or **30** to the end of the catalog number for sensor barrel diameter in mm.

² Add **12** or **18** to the end of the catalog number for sensor barrel diameter in mm.

For more information on our complete family of inductive proximity products, please visit:
<https://rok.auto/presence-sensing>



Proximity Sensors

Product Selection

2-Wire DC

Barrel Diameter	Nominal Sensing Distance [mm (in.)]	Shielded	Output Configuration	Switching Frequency (Hz)	Housing Length [mm (in.)]	Thread Length [mm (in.)]	Connection Type	Cat. No.
12 mm	2 (0.08)	Y	N.O.	75	61.0 (2.40)	26.4 (1.04)	Micro QD	871TM-DH2NE12-D4
	4 (0.16)	N				19.6 (0.77)		871TM-DH4NE12-D4
18 mm	5 (0.20)	Y		60	65.0 (2.56)	41.7 (1.64)		871TM-DH5NE18-D4
	8 (0.31)	N						871TM-DH8NE18-D4
30 mm	10 (0.39)	Y		40	66.3 (2.61)	41.9 (1.65)		871TM-DH10NE30-D4
	15 (0.59)	N				39.4 (1.55)		871TM-DH15NE30-D4



Looking for More?
 This catalog highlights only our most essential components; for a complete product selection, visit us at:
<https://rok.auto/directory>

Specifications

Certifications	UL Listed, CSA Certified, and CE Marked for all applicable directives
Enclosure Type Rating	NEMA 1, 2, 3, 3R, 4, 4X, 6, 6P, 12, 13; IP67 (IEC 529) all models; 1200 psi (8270 kPa) washdown; ToughLink™ and Micro connector versions are also rated IP69K (IEC 529)
Operating Temperature [C (F)]	-25...+70 ° (-13...+158 °)
Operating Voltage	10...30V DC
Protection Type	False pulse on power, transient noise, reverse polarity, short-circuit, overload
Load Current	≤ 25 mA
Housing Material	Stainless steel face and barrel

Required Cordsets and Accessories

Description	Cat. No.
DC Micro (M12) QD cordset, straight, 4-pin, 2 m (6.5 ft)	889D-F4AC-2
Right angle mounting bracket	871A-BRN ¹
Snap clamp mounting bracket	871A-SCP B ²

¹ Add **12**, **18**, or **30** to the end of the catalog number for sensor barrel diameter in mm.

² Add **12** or **18** to the end of the catalog number for sensor barrel diameter in mm.

<p>Photoelectric Sensors</p>  <p>6-2...6-47</p>	<p>Proximity Sensors</p>  <p>6-48...6-77</p>	<p>Ultrasonic Sensors</p>  <p>6-78...6-81</p>	<p>Limit Switches</p>  <p>6-82...6-93</p>	<p>Encoders</p>  <p>6-94...6-101</p>	<p>Condition Sensing</p>  <p>6-102...6-111</p>	<p>Identification Devices</p>  <p>6-112...6-115</p>
--	---	--	--	--	---	--

Product Selection

2-Wire AC/DC

Barrel Diameter	Nominal Sensing Distance [mm (in.)]	Shielded	Output Configuration	Switching Frequency [Hz]	Housing Length [mm (in.)]	Threaded Length [mm (in.)]	Cat. No.
12 mm	3 (0.12)	Yes	N.O.	35	83.4 (3.28)	38.4 (1.51)	871TM-B3N12-R3
	4 (0.16)	No		20		31.5 (1.24)	871TM-B4N12-R3
18 mm	5 (0.20)	Yes		20	84.3 (3.32)	60 (2.36)	871TM-B5N18-R3
	8 (0.31)	No		15		48.2 (1.90)	871TM-B8N18-R3
30 mm	10 (0.39)	Yes		15	85.7 (3.37)	61.3 (2.41)	871TM-B10N30-R3
	15 (0.59)	No		12		46.1 (1.81)	871TM-B15N30-R3

PLC Interfacer Models

Barrel Diameter [mm]	Nominal Sensing Distance [mm (in.)]	Shielded	Output Configuration	Switching Frequency [Hz]	Housing Length [mm (in.)]	Threaded Length [mm (in.)]	Cat. No.
12 mm	2 (0.08)	Yes	N.O.	75	61 (2.40)	26.4 (1.04)	871TM-BH2N12-R3
	4 (0.16)	No		35		19.6 (0.77)	871TM-BH4N12-R3
18 mm	5 (0.20)	Yes		65	65 (2.56)	41.7 (1.64)	871TM-BH5N18-R3
	8 (0.31)	No		30		41.7 (1.64)	871TM-BH8N18-R3
30 mm	10 (0.39)	Yes		45	66.3 (2.61)	41.9 (1.65)	871TM-BH10N30-R3
	15 (0.59)	No		20	66.3 (2.61)	39.4 (1.55)	871TM-BH15N30-R3

Note: PLC Interfacer Models feature low leakage current for improved compatibility with PLC inputs.

Specifications

Certifications	UL Listed, CSA Certified, and CE Marked for all applicable directives
Enclosure Type Rating	NEMA 1, 2, 3, 3R, 4, 4X, 6, 6P, 12, 13; IP67 (IEC 529) all models; 1200 psi (8270 kPa) washdown; ToughLink and Micro connector versions are also rated IP69K (IEC 529)
Operating Temperature [C (F)]	-25...+70 ° (-13...+158 °)
Operating Voltage	20...250V AC/DC
Protection Type	False pulse, transient noise, short-circuit, overload
Load Current	12 mm models: 5...200 mA; 18 & 30 mm models: 5...250 mA; PLC Interfacer models: 2...25 mA
Leakage Current, Max.	≤1.9 mA @ 120V AC (PLC Interfacer models: ≤0.9 mA @ 24V DC, ≤1.7 mA @ 20...120V AC, ≤2.5 mA @ 121...250V AC)
Housing Material	Stainless steel face and barrel

Required Cordsets and Accessories

Description	Cat. No.
AC Micro (M12) QD cordset, straight, 3-pin, 2 m (6.5 ft)	889R-F3ECA-2
Right angle mounting bracket	871A-BRN ¹
Snap clamp mounting bracket	871A-SCP ²

¹ Add **12**, **18**, or **30** to the end of the catalog number for sensor barrel diameter in mm.

² Add **12** or **18** to the end of the catalog number for sensor barrel diameter in mm.



Proximity Sensors

SENSORS

Food and Beverage 871TS

- Corrosion-resistant stainless steel housing with FDA Certified PPS sensing face
- IP67, IP68, and IP69K enclosure ratings
- Extended sensing range
- Extended temperature rating
- ECOLAB and Johnson Diversey Certified
- Smooth barrel models for sanitary applications (18 mm models)
- Laser etched product markings



Sensors for the Food & Beverage Industry

The Allen-Bradley 871TS food and beverage inductive proximity sensors are designed to address the most demanding applications in the food and beverage industry. These sensors withstand high pressure and high temperature washdown, while offering superior resistance to corrosion and damage caused by harsh cleansing agents.

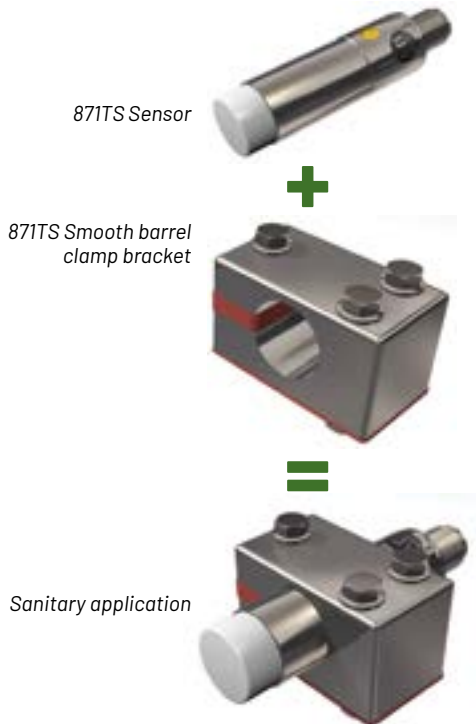

Photoelectric
Sensors



6-2...6-47

Proximity
Sensors



6-48...6-77

Ultrasonic
Sensors



6-78...6-81

Limit
Switches



6-82...6-93

Encoders



6-94...6-101

Condition
Sensing



6-102...6-111

Identification
Devices



6-112...6-115

Product Selection

4-Wire DC

Barrel Diameter	Barrel Type	Nominal Sensing Distance [mm (in.)]	Shielded	Output Configuration	Switching Frequency (Hz)	Housing Length [mm (in.)]	Thread Length [mm (in.)]	Connection Type	Cat. No.
12 mm	Threaded	4 (0.16)	Y	N.O. and N.C., PNP	2000	65.0 (2.56)	38.1 (1.50)	Micro QD	871TS-M4BP12-D4
		8 (0.31)	N				32.5 (1.28)		871TS-N8BP12-D4
18 mm	Threaded	8 (0.31)	Y		63.0 (2.48)	1500	34.5 (1.36)		871TS-M8BP18-D4
		12 (0.47)	N				26.5 (1.04)		871TS-N12BP18-D4
	Smooth	8 (0.31)	Y		63.0 (2.48)	-	871TS-MM8BP18-D4		
		12 (0.47)	N				871TS-NM12BP18-D4		



Need Help?

The Rockwell Automation Support Center is your 24/7 support for the answers you need now.

<https://rok.auto/support>

Specifications

Certifications	cULus Listed and CE Marked for all applicable directives; ECOLAB and Johnson and Diversey Certified
Enclosure Type Rating	IP67, IP68, and IP69K (IEC 529)
Operating Temperature [C (F)]	-40...+80 ° (-40...+176 °)
Operating Voltage	10...30V DC
Protection Type	False pulse on power, transient noise, reverse polarity, short-circuit, overload
Load Current	≤200 mA
Housing Material	Stainless steel 316L barrel and PPS sensing face (FDA Certified)

Required Cordsets and Accessories

Description	Cat. No.
DC Micro (M12) QD cordset, straight, 4-pin, 2 m (6.5 ft)	889D-F4AC-2
Right angle mounting bracket	871A-BRN ¹
Snap clamp mounting bracket	871A-SCPB ²
Smooth barrel clamp bracket, stainless steel, 18 mm	60-BCS-18B

¹ Add **12** or **18** to the end of the catalog number for sensor barrel diameter in mm.

² Add **12** or **18** to the end of the catalog number for sensor barrel diameter in mm.



Proximity Sensors

SENSORS

Weld Field Immune with Equal Sensing 871ZT

- Equal sensing distance for all metals
- Weld-field immune
- Weld-slag resistant PTFE-coated brass barrel and face
- Extended sensing range
- IP67, IP69K, and 1200 psi washdown rated
- 360° visible LED status indicator



The Full-featured Line for Welding Applications

The 871ZT inductive proximity sensors are equal sensing models – they sense all metals at nearly the same distance. Plus, these special weld-field immune models are ideal for welding environments and other applications where large magnetic fields are present.

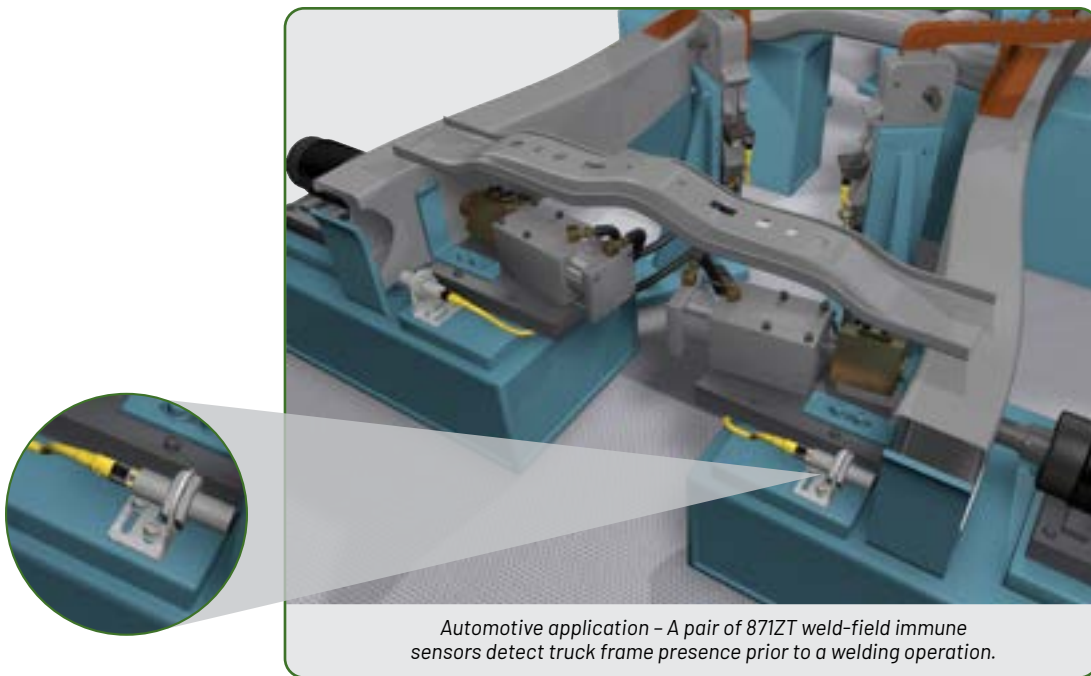

Automotive application – A pair of 871ZT weld-field immune sensors detect truck frame presence prior to a welding operation.

Photoelectric Sensors



6-2...6-47

Proximity Sensors



6-48...6-77

Ultrasonic Sensors



6-78...6-81

Limit Switches



6-82...6-93

Encoders



6-94...6-101

Condition Sensing



6-102...6-111

Identification Devices



6-112...6-115

Product Selection

3-Wire DC

Barrel Diameter	Nominal Sensing Distance [mm (in.)]	Shielded	Output Configuration	Switching Frequency [Hz]	Housing Length [mm (in.)]	Thread Length [mm (in.)]	Connection Type	Cat. No.
12 mm	3 (0.12)	Yes	N.O., PNP	2000	65.0 (2.56)	50.0 (1.97)	Micro QD	871ZT-MB3NP12-D4
	8 (0.31)	No				40.0 (1.58)		871ZT-NB8NP12-D4
18 mm	5 (0.20)	Yes		2500		50.0 (1.97)		871ZT-MB5NP18-D4
	12 (0.47)	No				40.0 (1.58)		871ZT-NB12NP18-D4
30 mm	10 (0.39)	Yes		600		50.5 (1.99)		871ZT-MB10NP30-D4
	20 (0.79)	No				1000		37.5 (1.48)



Sales Offices and Distributors

Our network of sales offices and distributors offers exceptional knowledge and service to help you design, implement and support your automation investment.

<https://rok.auto/buy>

Specifications

Certifications	cULus Listed and CE Marked for all applicable directives
Enclosure Type Rating	NEMA 1, 2, 3, 3R, 4, 4X, 6, 6P, 12, 13; IP67 (IEC 529)
Operating Temperature [C (F)]	-25...+70 ° (-13...+158 °)
Operating Voltage	10...30V DC
Protection Type	False pulse, transient noise, reverse polarity, short-circuit (trigger at 340 mA typical), overload
Load Current	≤200 mA
Leakage Current, Max.	≤0.08 mA
Housing Material	PTFE-coated brass barrel and PTFE face

Required Cordsets and Accessories

Description	Cat. No.
DC Micro (M12) ToughWeld™ QD cordset, straight, 4-pin, 2 m (6.5 ft)	889D-F4WE-2
Right angle mounting bracket	871A-BRN ¹
Snap clamp mounting bracket	871A-SCPB ²

¹ Add **12**, **18**, or **30** to the end of the catalog number for sensor barrel diameter in mm.

² Add **12** or **18** to the end of the catalog number for sensor barrel diameter in mm.



Proximity Sensors

SENSORS

Weld Field Immune 871Z

- Weld-field immune
- PTFE-coated brass barrel
- High-heat and weld slag resistant face
- Three-wire DC or two-wire AC/DC models



Tough Sensors for Automotive Applications

The 871Z inductive proximity sensors are special weld-field immune models ideal for welding environments and other applications where large magnetic fields are present.

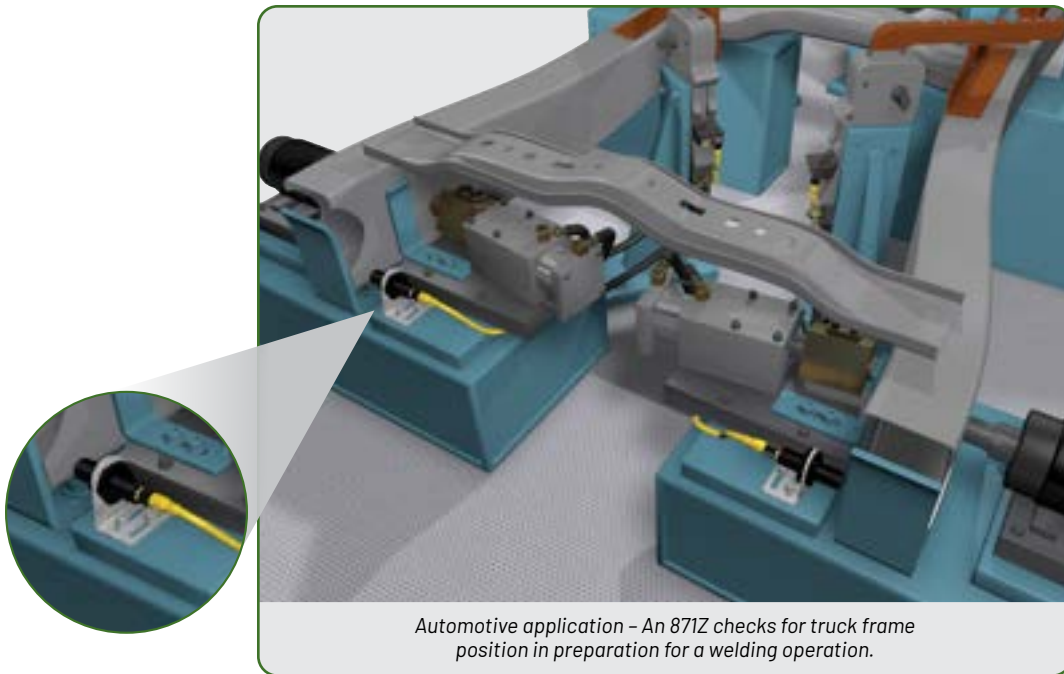

Automotive application - An 871Z checks for truck frame position in preparation for a welding operation.

Photoelectric
Sensors



6-2...6-47

**Proximity
Sensors**



6-48...6-77

Ultrasonic
Sensors



6-78...6-81

Limit
Switches



6-82...6-93

Encoders



6-94...6-101

Condition
Sensing



6-102...6-111

Identification
Devices



6-112...6-115

Product Selection

3-Wire DC

Barrel Diameter	Nominal Sensing Distance [mm (in.)]	Shielded	Output Configuration	Switching Frequency [Hz]	Housing Length [mm (in.)]	Thread Length [mm (in.)]	Connection Type	Cat. No.
12 mm	2 (0.08)	Yes	N.O., PNP	15	70.0 (2.76)	50.0 (1.97)	Micro QD	871Z-DW2NP12-D4
18 mm	5 (0.20)				80.0 (3.15)	60.0 (2.36)		871Z-DW5NP18-D4
30 mm	10 (0.39)				80.0 (3.15)	60.0 (2.36)		871Z-DW10NP30-D4

2-Wire AC/DC

Barrel Diameter	Nominal Sensing Distance [mm (in.)]	Shielded	Output Configuration	Switching Frequency (Hz)	Housing Length [mm (in.)]	Thread Length [mm (in.)]	Connection Type	Cat. No.
12 mm	2 (0.07)	Y	N.O.	30	90.1 (3.55)	46.7 (1.85)	Micro QD (1/2-20 UNF-2 A)	871Z-BW2N12-R3
	4 (0.15)	N				39.7 (1.56)		871Z-BW4N12-R3
18 mm	5 (0.19)	Y			83.5 (3.29)	61.6 (2.43)		871Z-BW5N18-R3
30 mm	10 (0.39)	Y			86.0 (3.38)	64.3 (2.53)		871Z-BW10N30-R3

Specifications

Certifications	UL Listed, CSA Certified, and CE Marked for all applicable directives
Enclosure Type Rating	NEMA 1, 2, 3, 4, 12, 13; IP67 (IEC 529)
Operating Temperature [C (F)]	-25...+70 ° (-13...+158 °)
Operating Voltage	10...30V DC, 20...250V AC/DC
Protection Type	False pulse on power, transient noise, short-circuit, overload
Load Current	200 mA DC, 5...200 mA for 12 mm AC/DC, 5...250 mA for 18 and 30 mm AC/DC
Housing Material	PTFE-coated brass

Required Cordsets and Accessories

Description	Cat. No.
DC Micro (M12) ToughWeld QD cordset, straight, 4-pin, 2 m (6.5 ft)	889D-F4WE-2
AC Micro (M12) ToughWeld QD cordset, straight, 3-pin, 2 m (6.5 ft)	889R-F3WEA-2
Right angle mounting bracket	871A-BRN ¹
Snap clamp mounting bracket	871A-SCPB ²

¹ Add **12**, **18**, or **30** to the end of the catalog number for sensor barrel diameter in mm.

² Add **12** or **18** to the end of the catalog number for sensor barrel diameter in mm.



Proximity Sensors

SENSORS

Miniature Rectangular 871FM

- Space-critical applications
- Equal sensing distance for all metals (select models)
- Cable, Micro QD, Pico QD, and Pico QD on 6-inch pigtail
- Stainless steel, chrome-plated brass and plastic housings
- IP67 or IP69K rated
- Factor-1/equal sensing auto detect NPN or PNP on power-up for 871FM Metal Flat Pack



Smaller Sensors for Your Hard-to-reach Applications

There are some applications that can't be solved with an industry standard-sized proximity sensor. Whether the application you're trying to solve is part of the semiconductor industry, or you're an OEM who manufactures machines which generate miniature parts, these sensors are able to go where traditional proximity sensor sizes cannot. These IO-Link enabled miniature inductive proximity sensors are ideal for applications where limited space - not sensing distance - is the driving factor.

5 mm x 22 mm x 5 mm (W x L x H)
(actual size)



20 mm x 32 mm x 8 mm (W x L x H)
(actual size)



30 mm x 52 mm x 14 mm
(W x L x H)(actual size)



Weld Slag Resistance



871FM Miniature Rectangular sensors can be applied where traditional tubular proximity sensors cannot, whether you're trying to sense small parts, space is at a premium, or both.

6-68

Photoelectric Sensors



6-2...6-47

Proximity Sensors



6-48...6-77

Ultrasonic Sensors



6-78...6-81

Limit Switches



6-82...6-93

Encoders

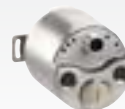

6-94...6-101

Condition Sensing



6-102...6-111

Identification Devices



6-112...6-115

Product Selection

3-Wire DC

Dimensions w x h x d [mm (in.)]	Nominal Sensing Distance [mm (in.)]	Shielded	Output Configuration	Switching Frequency (Hz)	Weld Immune	Connector Type	Cat. No.	
5 x 22 x 5 (0.19 x 0.86 x 0.19)	0.8 (0.03)	Y	N.O., PNP	5,000	-	2 m cable	871FM-M1NP5-E2	
	1.5 (0.05)	Y		3,000	-		871FM-M2NP5-E2	
5 x 25 x 5 (0.20 x 0.98 x 0.20)	0.8 (0.03)	Y		5,000	-	Pico QD with 6" pigtail	871FM-M1NP5-AP3	
	1.5 (0.05)	Y		3,000	-	Pico QD with 6" pigtail	871FM-M2NP5-AP3	
8 x 35 x 8 (0.31 x 1.37 x 0.31)	2 (0.07)	Y		3,000	-	2 m cable	871FM-M2NP8-E2	
	3 (0.11)	N		1,000	-		871FM-N3NP8-E2	
8 x 50 x 8 (0.31 x 1.97 x 0.31)	2 (0.07)	Y		3,000	-	Pico QD	871FM-M2NP8-P3	
28 x 16 x 11 (1.10 x 0.62 x 0.43)	2 (0.07)	Y		600	-	Pico QD	871FM-D2NP11-P3	
20 x 8 x 32 (0.78 x 0.31 x 1.25)	7 (0.27)	Y		Complementary N.O/N.C., auto detect NPN or PNP on power-up	≤200	No	PVC Pigtail, DC Micro QD, 4-pin	871FM-M7BA20-FD02
					≤200	No	PVC Cable, 2m	871FM-M7BA20-E2
			≤50		Yes - ToughCoat Finish™ weld slag coating	PVC Pigtail, DC Micro QD, 4-pin, Weld tube cable protection	871FM-MV7BA20-FD02X	
≤200	No	PVC Pigtail, DC Micro QD, 4-pin	871FM-M10BA30-FD02					
			871FM-M10BA30-E2					
≤50	Yes - ToughCoat Finish weld slag coating	PVC Pigtail, DC Micro QD, 4-pin, Weld tube cable protection	871FM-MV10BA30-FD02X					
			871FM-M7BA20-FP02					
20 x 8 x 32 (0.78 x 0.31 x 1.25)	7	Y	≤200		No	PVC Pigtail, DC Pico QD, 4-Pin	871FM-M7BA20-FP02	
			≤50		Yes - ToughCoat Finish weld slag coating	PVC Pigtail, DC Pico QD, 4-Pin	871FM-MV7BA20-FP02X	
30 x 14 x 52 (1.18 x 0.55 x 2.04)	10	Y	≤200		No	PVC Pigtail, DC Pico QD, 4-Pin	871FM-M10BA30-FP02	
30 x 14 x 52 (1.18 x 0.55 x 2.04)	10	Y	≤50	Yes - ToughCoat Finish weld slag coating	PVC Pigtail, DC Pico QD, 4-Pin	871FM-MV10BA30-FP02X		

IO-Link enabled.

Specifications

Certifications	CE Marked for all applicable directives
Enclosure Type Rating	IP67 (IEC 529)
Operating Temperature [C (F)]	-25...+70 °C (-13...+158 °F)
Operating Voltage	10...30V DC
Protection Type	False pulse on power, transient noise, reverse polarity, short circuit, overload
Load Current	≤50mA at 12V, ≤100mA for 20 x 8 x 32, 30 x 14 x 52 and ≤200 mA for all others
Housing Material	5 x 22 x 5 and 8 x 35 x 8 chrome-plated brass with plastic face; 20 x 8 x 32 and 30 x 14 x 52 all stainless steel; plastic for all other products

Required Cordsets and Accessories

Description	Cat. No.
DC Pico (M8) QD cordset, straight, 3-pin, 2 m (6.5 ft), PVC	889P-F3AB-2
DC Pico (M8) QD cordset, straight, 4-pin, 2 m (6.5 ft), PVC	889P-F4AB-2
Point I/O IO-Link Master Module	1734-4IOL
ArmorBlock IO-Link Master	1732E-8IOLM12R
DC Micro (M12) QD cordset, straight, 4-pin, 2 m (6.5 ft), PVC	889D-F4AB-2
DC Micro (M12) QD cordset, straight, 4-pin, 2 m (6.5 ft), CPE	889D-F4WE-2
DC Pico (M8) QD cordset, straight, 4-pin, 2 m (6.5 ft), TPE	889P-F4HB-2

For more information on our complete family of inductive proximity products, please visit:
<https://rok.auto/presence-sensing>



Proximity Sensors

SENSORS

VersaCube™ Equal Sensing 871P

- Weld-field immune with optional ToughCoat Finish™
- Factor-1/equal sensing for all metals
- Five-position sensing face
- Enhanced-visibility status LEDs
- Optional heavy duty model with metal base
- Unique jam nut and L-bracket mounting option



Equal Sensing, Versatility, and Durability

These 4-wire DC sensors integrate standard and specialty features into a 40 mm rectangular housing suited for general purpose and welding applications. For the most demanding welding applications, the 871P VersaCube can be ordered with ToughCoat Finish (our patented weld-slag resistant coating).

Changing the Sensing Head Position

To switch the sensing head between top and side sensing positions, follow these steps:



Mounting



Standard Zinc
Mounting Bracket

Optional Stainless Steel
Mounting L-Bracket

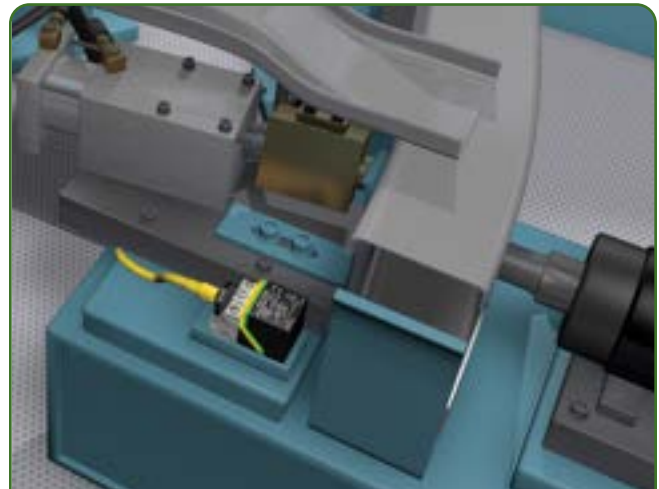

Automotive application - A VersaCube detecting the presence of a truck frame prior to initiating a weld.

6-70

Photoelectric
Sensors



6-2...6-47

Proximity
Sensors



6-48...6-77

Ultrasonic
Sensors



6-78...6-81

Limit
Switches



6-82...6-93

Encoders



6-94...6-101

Condition
Sensing



6-102...6-111

Identification
Devices



6-112...6-115

Product Selection

4-Wire DC ¹

Dimensions w x h x d [mm (in.)]	Nominal Sensing Distance [mm (in.)]	Shielded	Output Configuration	Switching Frequency (Hz)	Weld Field Immune	Connector Type	Cat. No.	
40 x 68.2 x 40 (1.57 x 2.68 x 1.57)	20 (0.79)	Y	N.O. and N.C., PNP	40	Y	Micro QD	871P-D20BP40-D4	
	40 (1.57)	N					871P-D40BP40-D4	
	20 (0.79)	Y			Yes - ToughCoat Finish™ weld slag coating		871P-DV20BP40-D4	
	40 (1.57)	N					871P-DV40BP40-D4	
40 x 68.2 x 40 (1.57 x 2.68 x 1.57)	20 (0.79)	Y					Y	871P-D20BP40-D4
	40 (1.57)	N						871P-D40BP40-D4
	20 (0.79)	Y			Yes - ToughCoat Finish™ weld slag coating		Y	871P-DV20BP40-D4
	40 (1.57)	N						871P-DV40BP40-D4
40 x 68.2 x 40 (1.57 x 2.68 x 1.57)	20 (0.79)	Y					Y	871P-DP20BP40-D4
	40 (1.57)	N					Y	871P-DP40BP40-D4
	20 (0.79)	Y			Yes - ToughCoat Finish™ weld slag coating			871P-DPV20BP40-D4
	40 (1.57)	N			Yes - ToughCoat Finish™ weld slag coating			871P-DPV40BP40-D4

¹ All units ship with a standard zinc mounting bracket.

Specifications

Certifications	cULus Listed and CE Marked for all applicable directives
Enclosure Type Rating	NEMA 1, 2, 3, 4, 6, 12, 13; IP67, IP68, and IP69K (IEC 529)
Operating Temperature [C (F)]	-25...+70 ° (-13...+158 °)
Operating Voltage	10...30V DC
Protection Type	False pulse on power, transient noise, short-circuit, overload, reverse polarity
Load Current	≤200 mA from 25...50 °C (77...122 °F) ≤100 mA from 50...70 °C (122...158 °F)
Housing Material	PBT housing, acrylic lens covers and zinc base

Required Cordsets and Accessories

Description	Cat. No.
DC Micro (M12) QD ToughWeld cordset, straight, 4-pin, 2 m (6.5 ft)	889D-F4WE-2
Standard zinc mounting bracket	871A-PBR
Stainless steel L-bracket (with 22 mm plastic mounting nut)	871A-BRS59
22 mm plastic mounting nut	871T-N9

For more information on our complete family of inductive proximity products, please visit:
<https://rok.auto/presence-sensing>



Proximity Sensors

SENSORS

VersaCube™ General Purpose 871P

- General purpose and weld-field immune versions
- Weld-slag resistant PEEK housing (WFI models)
- One-piece housing and mounting bracket
- Five-position sensing face



General Purpose Model

Long Range General-purpose Sensing

The VersaCube package is ideal for applications that require long-range sensing in a compact sensor. Their size is approximately half that of a NEMA style limit switch. In fact, the mounting holes on the VersaCube base align with the standard NEMA limit switch mounting holes allowing for an easy and convenient retrofit.

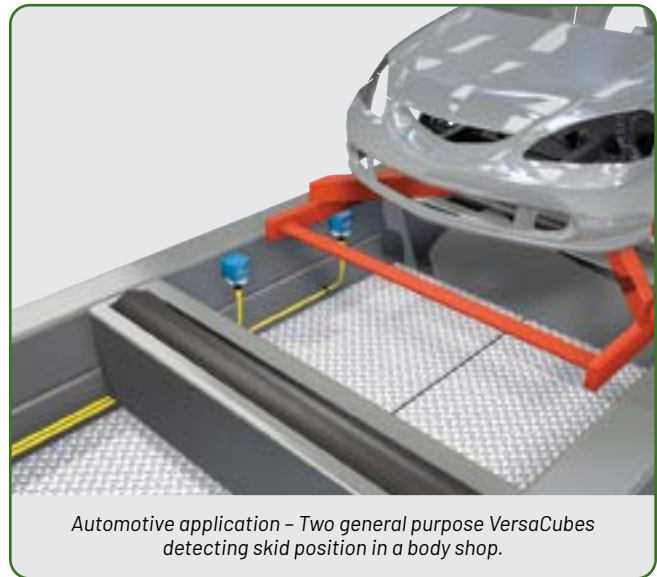
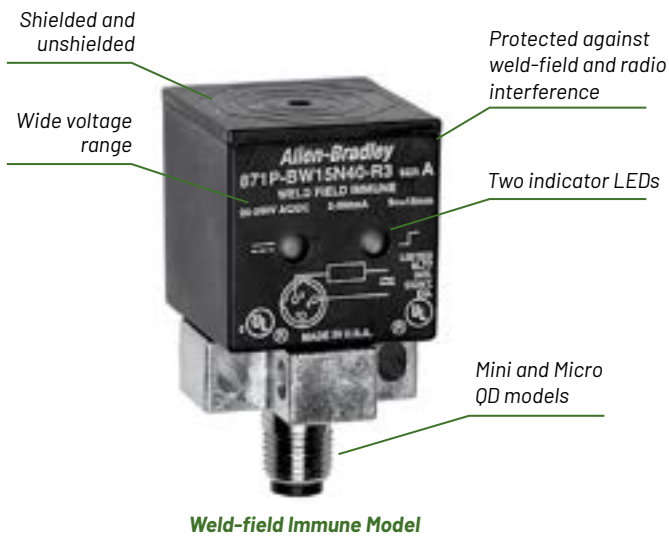

Photoelectric Sensors



6-2...6-47

Proximity Sensors



6-48...6-77

Ultrasonic Sensors



6-78...6-81

Limit Switches



6-82...6-93

Encoders



6-94...6-101

Condition Sensing



6-102...6-111

Identification Devices



6-112...6-115

Product Selection

2-Wire AC/DC

Dimensions w x h x d [mm (in.)]	Weld Field Immune	Nominal Sensing Distance [mm (in.)]	Shielded	Output Configuration	Switching Frequency (Hz)	Connector Type	Cat. No.
40 x 68.7 x 40 (1.57 x 2.70 x 1.57)	N	20 (0.79)	Y	N.O.	30	Micro QD (1/2-20 UNF-2A)	871P-B20N40-R3
		40 (1.57)	N		20		871P-B40N40-R3
	Y	15 (0.59)	Y		30		871P-BW15N40-R3
		25 (0.98)	N		20		871P-BW25N40-R3



Looking for More?
 This catalog highlights only our most essential components; for a complete product selection, visit us at:
<https://rok.auto/directory>

Specifications

Certifications	cULus Listed and CE Marked for all applicable directives
Enclosure Type Rating	NEMA 1, 2, 3, 4, 6, 6P, 12, 13; IP67 and IP69K (IEC 529)
Operating Temperature [C (F)]	-25...+70 ° (-13...+158 °)
Operating Voltage	20...250V AC/DC
Protection Type	False pulse on power, transient noise, short-circuit, overload
Load Current	100 mA for standard versions and 300 mA for WFI versions
Housing Material	Plastic body and zinc base

Required Cordsets and Accessories

Description	Cat. No.
AC Micro (M12) QD cordset, straight, 3-pin, 2 m (6.5 ft)	889R-F3ECA-2
Mounting kit ¹	871A-PKIT
Limit Switch style mounting kit (w/22 mm plastic mounting nut)	871A-PKITLS
PTFE cover - short	871A-KCT40-F
PTFE cover - long	871A-KCT40-T

¹ Each mounting kit includes a ground lug, a ground screw, and an optional adaptor for competitive retrofits.



Proximity Sensors

SENSORS

Flat Pack 871F

- General purpose and weld-field immune versions
- Sensing ranges up to 65 mm (2.55 in.)
- Through-hole or DIN Rail mounting
- Complementary N.O. and N.C. outputs



Maximum Sensing Range

The 871F is ideal for applications that require long sensing range - up to 65 mm (2.55 in.). This sensor is often used in material handling and welding applications.

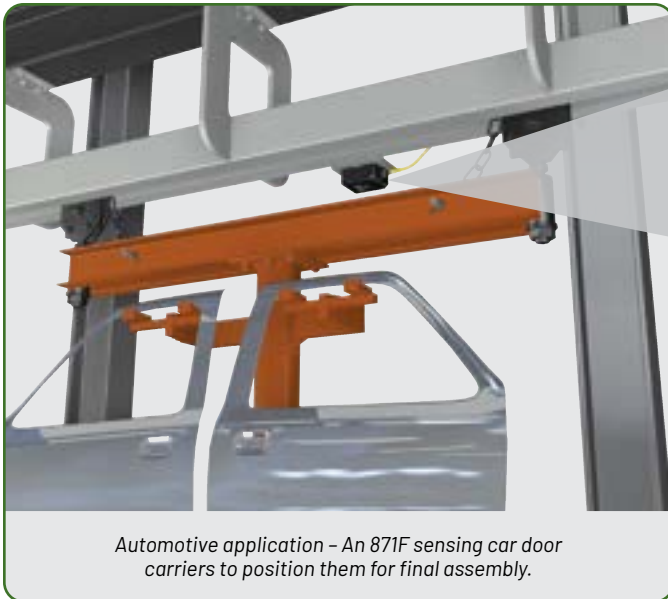

Automotive application - An 871F sensing car door carriers to position them for final assembly.

Mounting Requirements

Shielded units must be fully embedded in mild steel to achieve maximum sensing distance.



Photoelectric
Sensors



6-2...6-47

**Proximity
Sensors**



6-48...6-77

Ultrasonic
Sensors



6-78...6-81

Limit
Switches



6-82...6-93

Encoders



6-94...6-101

Condition
Sensing



6-102...6-111

Identification
Devices



6-112...6-115

Product Selection

4-Wire DC

Dimensions w x h x d [mm (in.)]	Weld Field Immune	Nominal Sensing Distance [mm (in.)]	Shielded	Output Configuration	Switching Frequency (Hz)	Connector Type	Cat. No.
83 x 94 x 40 (3.26 x 3.70 x 1.57)	N	50 (1.96)	Y	N.O. and N.C., PNP	100	Micro QD	871F-P50BP80-D4
		65 (2.55)	N				871F-N65BP80-D4
	Y	40 (1.57)	Y		15		871F-PW40BP80-D4
		50 (1.96)	N				871F-NW50BP80-D4

2-Wire AC/DC

Dimensions w x h x d [mm (in.)]	Weld Field Immune	Nominal Sensing Distance [mm (in.)]	Shielded	Output Configuration	Switching Frequency (Hz)	Connector Type	Cat. No.
83 x 94 x 40 (3.26 x 3.70 x 1.57)	N	50 (1.96)	Y	N.O.	10	Micro QD (1/2-20 UNF-2A)	871F-R50N80-R3
		65 (2.55)	N				871F-K65N80-R3
	Y	40 (1.57)	Y				871F-JW40N80-R3
		50 (1.96)	N				871F-KW50N80-R3

Specifications

Certifications	UL Listed, cUL Certified, and CE Marked for all applicable directives
Enclosure Type Rating	NEMA 1, 2, 3, 4, 6, 6P, 12, 13; IP67 and IP69K (IEC 529)
Operating Temperature [C (F)]	-25...+70 °C (-13...+158 °F)
Operating Voltage	10...30V DC or 20...250V AC/DC
Protection Type	False pulse on power, transient noise, short circuit, overload, reverse polarity
Load Current	DC models: ≤200 mA AC models: ≤100 mA
Housing Material	PBT

Required Cordsets

Description	Cat. No.
DC Micro (M12) QD cordset, straight, 4-pin, 2 m (6.5 ft)	889D-F4AC-2
AC Micro (M12) QD cordset, straight, 3-pin, 2 m (6.5 ft)	889R-F3ECA-2



Need Help?

The Rockwell Automation Support Center is your 24/7 support for the answers you need now.

<https://rok.auto/support>



Proximity Sensors

SENSORS

Capacitive 875F, 875L

- Metal, nonmetal solid, and liquid sensing
- Adjustable sensing distance (875L)
- Cylindrical (875L) and flat housing types (875F)
- IP67 and IP69K enclosures
- Cable or quick-disconnect styles



Reliably Detect a Variety of Materials

Unlike inductive proximity sensors, the 875F and 875L capacitive sensors can detect non-metal solids and liquids in addition to standard metal targets. They can even sense the presence of some targets through certain other materials, making them an ideal choice in those applications where the inductive proximity and photoelectric sensors cannot be used.



Photoelectric
Sensors



6-2...6-47

Proximity
Sensors



6-48...6-77

Ultrasonic
Sensors



6-78...6-81

Limit
Switches



6-82...6-93

Encoders



6-94...6-101

Condition
Sensing



6-102...6-111

Identification
Devices



6-112...6-115

Product Selection

3-Wire DC

Barrel Diameter	Product Type	Sensing Distance	Output Configuration	Connection	Rockwell Cat #
30	Flush	16	Normally Open PNP	DC Micro Quick Disconnect	875L-M16NP30-D4 
			Normally Open NPN		875L-M16NN30-D4 
			Normally Closed PNP		875L-M16CP30-D4 
			Normally Closed NPN		875L-M16CN30-D4 
	Non-Flush	25	Normally Open PNP	DC Micro Quick Disconnect	875L-N25NP30-D4 
			Normally Open NPN		875L-N25NN30-D4 
			Normally Closed PNP		875L-N25CP30-D4 
			Normally Closed NPN		875L-N25CN30-D4 
18	Flush	8	Normally Open PNP	DC Micro Quick Disconnect	875L-M8NP18-D4 
			Normally Open NPN		875L-M8NN18-D4 
			Normally Closed PNP		875L-M8CP18-D4 
			Normally Closed NPN		875L-M8CN18-D4 
	Non-Flush	12	Normally Open PNP	DC Micro Quick Disconnect	875L-N12NP18-D4 
			Normally Open NPN		875L-N12NN18-D4 
			Normally Closed PNP		875L-N12CP18-D4 
			Normally Closed NPN		875L-N12CN18-D4 
Flat	Flush	10	Normally Open PNP	0.2 m PVC Cable 4-Pin DC Pico	875F-M10NP34-FP02
			Normally Open NPN		875F-M10NN34-FP02
			Normally Closed PNP		875F-M10CP34-FP02
			Normally Closed NPN		875F-M10CN34-FP02

 IO-Link enabled.

Specifications

Certifications	CE Marked for all applicable directives
Enclosure Type Rating	IP65, IP66, IP67, IP68 @ 1.3 m and 24 h; IP69K (NEMA 1, 2, 4, 4x, 5, 12)
Operating Temperature [C (F)]	-25...+80 °C (-13...+176 °F)
Operating Voltage	10...30V DC
Protection Type	False pulse on power, transient noise, reverse polarity, short circuit, overload, temperature fault, quality of run
Load Current	13 mA
Housing Material	PBT housing

Accessories

Description	Cat. No.
DC Pico (M8) QD cordset, straight, 3-pin, 2 m (6.5 ft), PVC	889P-F3AB-2
DC Pico (M8) QD cordset, straight, 4-pin, 2 m (6.5 ft), PVC	889P-F4AB-2
Point I/O IO-Link Master Module	1734-4IOL
ArmorBlock IO-Link Master	1732E-8IOLM12R
DC Micro (M12) QD cordset, straight, 4-pin, 2 m (6.5 ft), PVC	889D-F4AB-2
DC Micro (M12) QD cordset, straight, 4-pin, 2 m (6.5 ft), CPE	889D-F4WE-2
DC Pico (M8) QD cordset, straight, 4-pin, 2 m (6.5 ft), TPE	889P-F4HB-2

For more information on our complete family of inductive proximity products, please visit:
<https://rok.auto/presence-sensing>



Ultrasonic Sensors

SENSORS

18, 30 and 38.8 mm Plastic Discrete and Analog 873P

- Detect clear, shiny or non-reflective objects
- Sensing range up to 6 m (19.6 ft)
- Push button programming
- Discrete output models (single set-point or window mode)
- Scalable analog output models
- Wide range of operating voltages
- Synchronization on select models to prevent crosstalk
- Four output modes



A Sound Solution

The 873P ultrasonic sensors use reflected sound waves to detect targets – such as clear, shiny, or non-reflective objects – that can be challenging for other sensing technologies. The 873P sensors offer a wide range of operating voltages, simple push-button setup and a synchronization feature to reduce cross-talk between adjacent sensors.

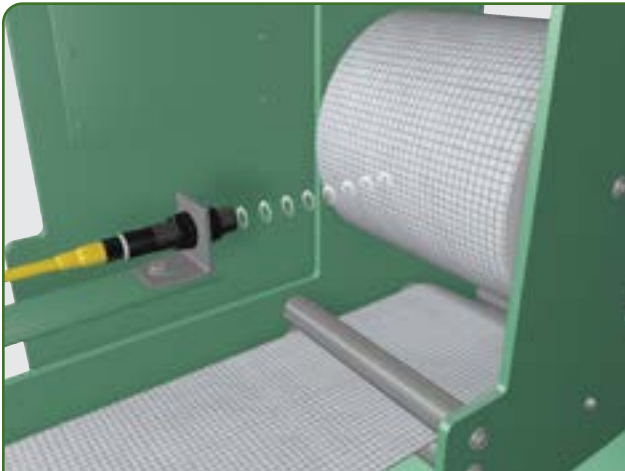

Roll diameter and tank level – An 873P analog ultrasonic continuously measures roll diameter or tank level and provides a proportional 4...20 mA or 0...10V DC output. If a dual discrete output sensor is used, one switch point is set for low level indication and the other set for a full condition.

Ultrasonic Sensors

Photoelectric Sensors



6-2...6-47

Proximity Sensors



6-48...6-77



6-78...6-81

Limit Switches



6-82...6-93

Encoders



6-94...6-101

Condition Sensing



6-102...6-111

Identification Devices



6-112...6-115

Product Selection

18 and 30 mm Plastic Discrete and Analog

Sensing Distance [mm (in.)] ¹	Beam Angle	Operating Voltage	Switching Frequency [Hz]	Output Type	Resolution	Response Time	Transducer Frequency	Operating Temperature [C (F)]	Cat. No. ^{2,3}	
Single or Dual Discrete										
50...400 (1.97...15.75)	±8 °	15...30V DC	10 Hz	(1) PNP or (2) PNP	1 mm (0.04 in.)	50 ms	300 kHz	-20...+60 ° (-4...+140 °)	873P-D18PØ-400-D4	
100...900 (3.93...35.43)	±7 °		4 Hz		2 mm (0.08 in.)	125 ms			873P-D18PØ-900-D4	
200...2200 (7.87...86.61)			1 Hz		3 mm (0.12 in.)	500 ms			200 kHz	873P-D18PØ-2200-D4
200...2500 (7.87...98.42)	14 ° ±1 °	12...30V DC	2 Hz		2 mm (0.08 in.)	250 ms	150 kHz	-20...+70 ° (-4...+158 °)	873P-D18PØ-2500-D4	
250...3500 mm (9.84...137.80)	15 ° ±2 °				4 mm (0.16 in.)				112 kHz	873P-D30PØ-3500-D4
350...6000 mm (13.8...236.2 in.)			1 Hz		6 mm (0.24 in.)	75 kHz	873P-D30PØ-6000-D4			
Analog										
100...900 (3.93...35.43)	±7 °	15...30V DC	N/A	4...20 mA or 0...10V DC	2 mm	500 ms	300 kHz	-20...+60 ° (-4...140 °)	873P-D18⊗-900-D4	
200...2500 (7.87...98.42)	14 ±1 °	12...30V DC				600 ms	150 kHz	-20...+70 ° (-4...158 °)	873P-D30⊗-2500-D4	
350...6000 mm (13.8...236.2 in.)	15 ° ±2 °	12...30V DC				6 mm	600 ms	75 kHz	-20...+70 ° (-4...158 °)	873P-D30⊗-6000-D4
100...900 (3.93...35.43)	±7 °	15...30V DC				500 ms	300 kHz	-20...+60 ° (-4...140 °)	873P-D18⊗-900-D4	
200...2200 (7.87...86.61)									200 kHz	873P-D18⊗-2200-D4
350...6000 mm (13.8...236.2 in.)	15 ° ±2 °					6 mm	600 ms	75 kHz	-20...+70 ° (-4...158 °)	873P-D30⊗-6000-D4

¹ Blind Zone = 0 mm to minimum sensing distance

² The barrel diameter is indicated after the first **D** in the catalog number. For example, catalog number 873P-D18P1-400-D4 is an 18 mm barrel diameter and 873P-D30P1-2500-D4 is a 30 mm barrel diameter.

³ The **-D4** suffix indicates a 4-pin DC Micro (M12) **-QD** and the **-D5** suffix indicates a 5-pin DC Micro (M12) **QD**.

⊗ IO-Link enabled.

⊘ Insert 1 for (1) PNP and 2 for (2) PNP.

⊗ Insert 1 for 4...20 mA current output or V for 0...10V output. For Analog Current with (2) PNP, insert AIP2. For Analog Voltage with (2) PNP, insert AVP2.

Specifications

Certifications	cULus Listed and CE Marked for all applicable directives
Enclosure Type Rating	IP67
Current Consumption	<50 mA
Protection Type	Short circuit, reverse polarity, transient noise, overload
Housing Material	PBT
Repeatability	0.1% up to 3.5 m, 0.2% from 3.5 m to 6 m
Absolute Accuracy	0.1% of sensing range (analog only)
Sensor Voltage Drop	<2.2V DC (discrete only)
Hysteresis	1% of full scale value

Required Cordsets and Accessories

Description	Cat. No.
DC Micro (M12) QD cordset, straight, 4-pin, 2 m (6.5 ft)	889D-F4AC-2
DC Micro (M12) QD cordset, straight, 5-pin, 2 m (6.5 ft)	889D-F5AC-2
Swivel/tilt style mounting bracket (M18)	60-2649
Swivel/tilt style mounting bracket (M30)	60-2439
Zinc-plated steel right angle bracket (M18)	871A-BRN18
Stainless steel right angle bracket (M18)	871A-BRS18
Zinc-plated steel right angle bracket (M30)	871A-BRN30
Stainless steel right angle bracket (M30)	871A-BRS30
Point I/O IO-Link Master	1734-4IOL
ArmorBlock IO-Link Master	1732E-8IOLM12R

For more information on our complete family of ultrasonic products, please visit:
<https://rok.auto/presence-sensing>



Ultrasonic Sensors

SENSORS

18 mm Metal General Purpose 873M

- Detect clear, shiny, or non-reflective objects
- Sensing range up to 800 mm (31.5 in.)
- Compact 18 mm (0.71 in.) housing
- Scalable analog output models
- Teachable discrete output models (single set-point or window mode)
- Remote teach or optional programming cable



Compact Clear Object Detection

The 873M general purpose ultrasonic sensors detect solid or liquid targets by using sound waves. These compact sensors are a great solution for areas with limited space and are excellent for standard packaging and assembly applications. They are ideal for sensing targets that are challenging for photoelectric sensors to detect, including clear, shiny, or non-reflective objects.



Film position detection - An 873M ultrasonic checks for continual feed of a clear wrap while monitoring tension.



Part counting - A right angle 873M counts bottles that, due to color, luster and clarity, might be difficult to sense with photoelectric sensors.

Ultrasonic Sensors

Photoelectric Sensors



6-2...6-47

Proximity Sensors



6-48...6-77



6-78...6-81

Limit Switches



6-82...6-93

Encoders

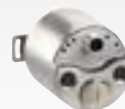

6-94...6-101

Condition Sensing



6-102...6-111

Identification Devices



6-112...6-115

Product Selection

18 mm Metal General Purpose

Sensing Distance [mm (in.)] ¹	Sensing Direction	Operating Voltage	Switching Frequency [Hz]	Output Type	Repeatability	Transducer Frequency	Response Time	Cat. No.
30...300 (1.18...11.8)	Straight	10...30V DC	13	PNP, Selectable N.O./N.C.	<1%	390 kHz	30 ms	873M-D18P0300-D4
								873M-D18RP0300-D4
	Right angle	15...30V DC	N/A	4...20 mA	±0.5% of full-scale value	873M-D18RAI300-D4		
				0...10V DC		873M-D18RAV300-D4		
	Straight	10...30V DC	N/A	4...20 mA	±0.5% of full-scale value	873M-D18AI300-D4		
				0...10V DC		873M-D18AV300-D4		
50...800 (1.97...31.5)	Straight	10...30V DC	4	PNP, Selectable N.O./N.C.	<1%	255 kHz	100 ms	873M-D18P0800-D4
								873M-D18RP0800-D4
	Right angle	10...30V DC	N/A	4...20 mA	±0.5% of full-scale value	873M-D18RAI800-D4		
				0...10V DC		873M-D18RAV800-D4		
	Straight	10...30V DC	N/A	4...20 mA	±0.5% of full-scale value	873M-D18AI800-D4		
				0...10V DC		873M-D18AV800-D4		

¹ Blind Zone = 0 mm to minimum sensing distance

Specifications

Certifications	cULus Listed and CE Marked for all applicable directives
Barrel Size	M18
Enclosure Type Rating	IP67
Operating Temperature [C (F)]	-25...+70 ° (-13...+158 °)
Protection Type	Short circuit, overload, reverse polarity
Load Current	200 mA
Current Consumption	<20 mA
Housing Material	Nickel-plated brass
Resolution	0.4 mm at max. sensing range
Voltage Drop	<3V
Hysteresis	1% set operating distance

Required Cordsets and Accessories

Description	Cat. No.
DC Micro (M12) QD cordset, straight, 4-pin, 2 m (6.5 ft)	889D-F4AC-2
Zinc-plated steel right angle bracket	871A-BRN18
Programming cable	873M-ProgCable
Snap clamp mounting bracket (18 mm)	871A-SCBP18
Swivel/tilt style bracket (18 mm)	60-2649



Sales Offices and Distributors

Our network of sales offices and distributors offers exceptional knowledge and service to help you design, implement and support your automation investment.

<https://rok.auto/buy>



For more information on our complete family of ultrasonic products, please visit:
<https://rok.auto/presence-sensing>

Limit Switches

SENSORS

Oiltight Plug-in 802T

- Heavy duty
- Plug-in style
- Front mount
- Side rotary or side push styles
- Quick mode change (CW/CCW)
- Castle-lock head design



The Benchmark for Toughness and Reliability

The 802T limit switches are ideal for applications in which heavy-duty pilot ratings, small size, a high degree of versatility and a rugged NEMA Type 4, 13, and 6P construction are desirable. These limit switches are extensively applied in rugged and heavy-duty production environments.



6-82

Photoelectric Sensors



6-2...6-47

Proximity Sensors



6-48...6-77

Ultrasonic Sensors



6-78...6-81

Limit Switches



6-82...6-93

Encoders



6-94...6-101

Condition Sensing



6-102...6-111

Identification Devices



6-112...6-115

Product Selection – Oiltight Plug-in

Lever Type, Spring Return Standard and Low Operating Torque Models – Switch without Lever

No. of Circuits	Lever Movement	Torque to Operate [N·m (lb·in.)]	Travel to Operate Contacts	Maximum Travel	Travel to Reset Contacts	Cat. No.
2	CW or CCW	0.29 (2.6) max.	13° max.	90°	7°	802T-AP
2	CW or CCW	0.29 (2.6) max.	18° max.	90°	7°	802T-A5P
2	CW or CCW	0.56 (5) max.	9° max.	90°	4°	802T-HP
2	CW	0.29 (2.6) max.	13° max.	90°	7°	802T-A1P
2	CW or CCW	0.106 (0.94) max.	13° max.	90°	7°	802T-ALP
4	CW or CCW	0.45 (4) max.	13° max.	90°	7°	802T-ATP
4	CW or CCW	0.79 (7) max.	9° max.	90°	4°	802T-HTP

Specifications

Certifications	UL Listed, CSA Certified, and CE Marked for all applicable directives
Enclosure Type Rating	NEMA 4, 6P, and IP67
Ambient Temperature [C (F)]	-18...+110 ° (0...230 °) Wobble stick & cat whisker models: -18...+54 ° (0...130 °)



Product Selection Tools

Available online or for download, our tools help you access info while in the office or on the go.

<https://rok.auto/selection>



Limit Switches

Product Selection – Oiltight Plug-in

Lever Type, Maintained Contact Models – Switch without Lever

No. of Circuits	Lever Movement	Torque to Operate	Travel to Operate Contacts	Maximum Travel	Travel to Reset Contacts	Cat. No.
2	CW or CCW	0.31 N•m (2.75 lb•in.) max.	70° max.	88°	32° max.	802T-AMP

Lever Type, Spring Return Neutral Position Models – Switch without Lever

No. of Circuits	Torque to Operate, Max.	Travel to Operate Contacts	Maximum Travel	Travel to Reset Contacts	Cat. No.
4	CW: 0.28 N•m (2.5 lb•in.), CCW: 0.47 N•m (4.2 lb•in.)	13° max.	75°	7° max.	802T-NPTP

Wobble Stick and Cat Whisker, Spring Return – Complete Switch

No. of Circuits	Operator Type	Torque to Operate	Travel to Operate Contacts	Maximum Travel	Travel to Reset Contacts	Cat. No.
2	Nylon wobble stick	0.51 N•m (4.5 lb•in.) max.	9° max.	10°	5° max.	802T-WSP
	Wire cat whisker	0.06 N•m (8 oz•in.) max.	21° max.	28°	14° max.	802T-CWP





Product Selection Tools

Available online or for download, our tools help you access info while in the office or on the go.

<https://rok.auto/selection>

<p>Photoelectric Sensors</p>  <p>6-2...6-47</p>	<p>Proximity Sensors</p>  <p>6-48...6-77</p>	<p>Ultrasonic Sensors</p>  <p>6-78...6-81</p>	<p>Limit Switches</p>  <p>6-82...6-93</p>	<p>Encoders</p>  <p>6-94...6-101</p>	<p>Condition Sensing</p>  <p>6-102...6-111</p>	<p>Identification Devices</p>  <p>6-112...6-115</p>
--	---	--	--	--	---	--

Product Selection – Oiltight Plug-in

Push Type, Spring Return – Complete Switch

No. of Circuits	Operator Type	Force to Operate [N (lb)]	Travel to Operate Contacts [mm (in.)]	Maximum Travel [mm (in.)]	Travel to Reset Contacts [mm (in.)]	Cat. No.
2	Top push rod	13.8 (3.1)	1.4 (0.057) max.	6.0 (0.236)	0.9 (0.034) max.	802T-BP
	Adjustable top push rod					802T-BAP
	Side push rod	16.4 (3.7)	3.3 (0.131) max.	5.7 (0.226)	1.9 (0.074) max.	802T-CP
					1.3 (0.052) max.	802T-CGP ¹
	Top push rod	13.8 (3.1)	1.4 (0.057) max.	6.0 (0.236)	0.9 (0.034) max.	802T-DP
					0.7 mm (0.028 in.)	802T-DGP ¹
	Side push vertical roller	16.4 (3.7)	3.3 (0.131) max.	5.7 (0.226)	1.9 (0.074) max.	802T-KP
					1.3 (0.052) max.	802T-KGP ¹
4	Top push rod	22.2 (5.0)	1.4 (0.057) max.	6.0 (0.236)	0.9 (0.034) max.	802T-BTP
						802T-DTP

¹ Low energy models.

Specifications

Certifications	UL Listed, CSA Certified, and CE Marked for all applicable directives
Enclosure Type Rating	NEMA 4, 6P, and IP67
Ambient Temperature [C (F)]	-18...+110 ° (0...230 °) Wobble stick & cat whisker models: -18...+54 ° (0...130 °)



Limit Switches

SENSORS

Pre-wired, Factory Sealed 802M and 802MC

- Harsh environment applications
- NEMA 4, 4X, 6P, and IP69K enclosure ratings
- Resistant to moisture and cleaning agents
- Submersible (802MC)
- Sealed, corrosion resistant versions with stainless steel shaft and hardware (802MC)
- Two- and four-circuit versions (only two-circuit for 802MC)
- Oil resistant cable on pre-wired models



For the Most Demanding Environments

The 802M and 802MC compact pre-wired limit switches are factory-sealed to meet the demanding requirements for NEMA Type 4, 4X, 6P, and IP67 enclosures. A large variety of operating heads and levers are available to suit a wide range of applications, especially where the switch may be subject to washdowns, steams of coolant, or occasionally submerged in fluids commonly found on machines or in industrial processes.

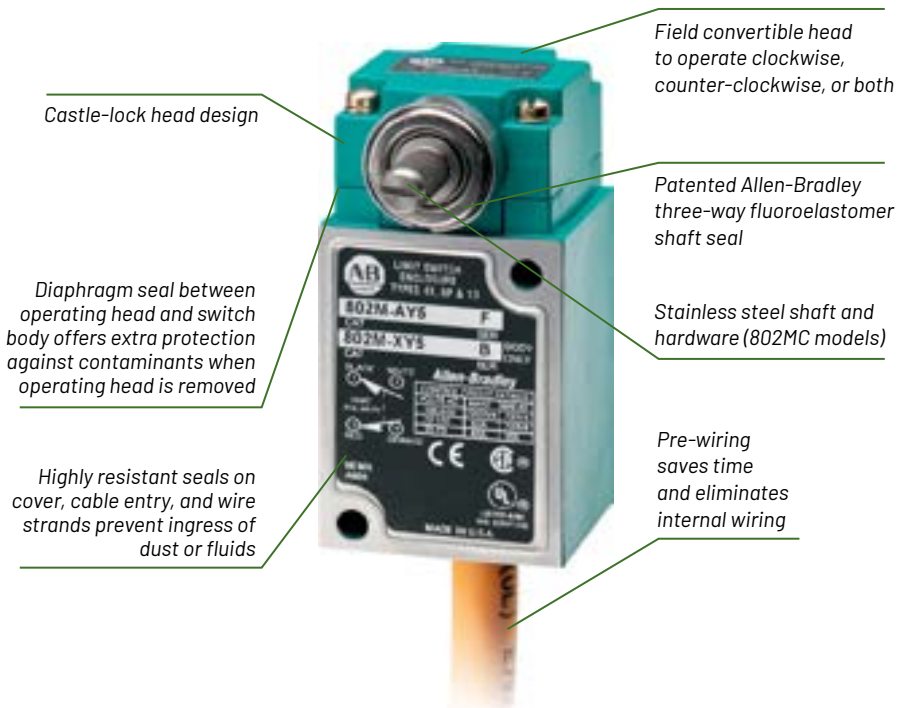

Photoelectric Sensors



6-2...6-47

Proximity Sensors



6-48...6-77

Ultrasonic Sensors



6-78...6-81

Limit Switches



6-82...6-93

Encoders



6-94...6-101

Condition Sensing



6-102...6-111

Identification Devices



6-112...6-115

Product Selection

Pre-wired, Factory Sealed

Description	Torque/Force to Operate, Max.	Travel to Operate Contacts, Max.	Maximum Travel	Travel to Reset Contacts, Max.	Connection Type	Cat. No.
Lever type - spring return	0.34 N•m (3 lb•in.)	15°	86°	6°	1.5 m (5 ft) cable	802M-AY5
Lever type - spring return corrosion resistant					5-pin mini QD	802M-AJ1
Lever type neutral position - spring return (4 circuit)	CW: 0.79 N•m (7 lb•in.), CCW: 0.85 N•m (7.5 lb•in.)	16°	75°	7°	1.5 m (5 ft) cable	802M-NPY5
Push type - spring return top push rod	13.3 N (3 lb)	1.45 mm (0.057 in.)	5.26 mm (0.207 in.)	0.56 mm (0.022 in.)	1.5 m (5 ft) cable	802M-BY5
Push type - spring return top push roller	14.7 N (3.3 lb)					802M-DY5
Push type - spring return side push vertical roller	20 N (4.5 lb)	2.59 mm (0.102 in.)	5.1 mm (0.203 in.)	1.14 mm (0.045 in.)	1.5 m (5 ft) cable	802M-KY5



Looking for More?
 This catalog highlights only our most essential components; for a complete product selection, visit us at:
<https://rok.auto/directory>

Specifications

Certifications	UL Listed, CSA Certified, and CE Marked for all applicable directives
Enclosure Type Rating	NEMA 1, 4, 6P, 13 and IP67 (802MC also NEMA 4X)
Ambient Temperature [C (F)]	0...80 ° (32...180 °)

Required Cordsets and Accessories

Description	Cat. No.
Mini plus QD cordset, straight, 5-pin, 1.8 m (6 ft)	889N-F5AFC-6F



Limit Switches

SENSORS

IEC 30 mm Metal 802K

- Rugged die-cast 30 mm housing
- Large selection of actuator heads
- Positive operation, forced disconnection of contacts
- Snap-acting, slow make before break, or slow break before make contact blocks
- Two- or four-contact configurations
- IP66 enclosure



Our Rugged, IEC-style Offering

The 802K limit switches have a range of options including snap action or slow break/make with two or four contact configurations and a choice of actuator heads. You can rotate the head in 90° increments before installation for easy mounting. Operation of these limit switches is achieved by the moving objects deflecting the plunger or lever.

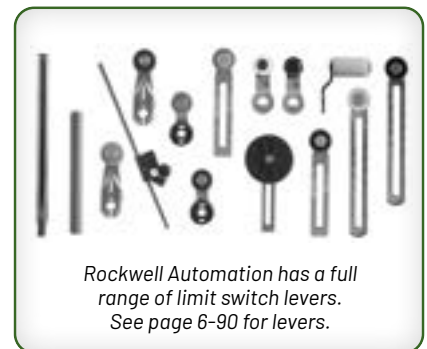

6-88

Photoelectric Sensors



6-2...6-47

Proximity Sensors



6-48...6-77

Ultrasonic Sensors



6-78...6-81

Limit Switches



6-82...6-93

Encoders



6-94...6-101

Condition Sensing



6-102...6-111

Identification Devices



6-112...6-115

Product Selection

IEC 30 mm Metal

Operator Type	Force/Torque to Operate, Max.	Contacts	Aux Contacts	Contact Action	Connection Type	Cat. No.
Metal roller plunger	11 N (2.5 lb)	2 N.C.	2 N.O.	BBM	1/2 in. NPT conduit	802K-MRPB22E
	13 N (2.9 lb)	1 N.C.	1 N.O.	Snap acting		802K-MRPS11E
						802K-MDPS11E
	11 N (2.5 lb)	2 N.C.	2 N.O.	BBM	1/2 in. NPT conduit	802K-MDPB22E
					M20 conduit	802K-MDPB22B
Metal short lever	0.34 N•m (3.01 lb•in.)	1 N.C.	1 N.O.	Snap acting	1/2 in. NPT conduit	802K-MSLS11E
					M20 conduit	802K-MSLS11B
	0.20 N•m (1.77 lb•in.)	4 N.C.	-	-	1/2 in. NPT conduit	802K-MSLB04E
	0.34 N•m (3.01 lb•in.)	2 N.C.	2 N.O.	BBM	1/2 in. NPT conduit	802K-MSLB22E
					M20 conduit	802K-MSLB22B
Metal short lever, metal roller	0.34 N•m (3.01 lb•in.)	1 N.C.	1 N.O.	Snap acting	1/2 in. NPT conduit	802K-MMHS11E
					M20 conduit	802K-MMHS11B
		2 N.C.	2 N.O.	BBM	1/2 in. NPT conduit	802K-MMHB22E
Metal adjustable lever	0.34 N•m (3.01 lb•in.)	1 N.C.	1 N.O.	Snap acting	1/2 in. NPT conduit	802K-MALS11E
					M20 conduit	802K-MALS11B
		2 N.C.	2 N.O.	BBM	1/2 in. NPT conduit	802K-MALB22E
				M20 conduit	802K-MALB22B	
Metal rod lever	0.34 N•m (3.01 lb•in.)	1 N.C.	1 N.O.	Snap acting	1/2 in. NPT conduit	802K-MARST1E
Metal spring rod	0.20 N•m (1.77 lb•in.)	1 N.C.	1 N.O.	Snap acting	1/2 in. NPT conduit	802K-MSRS11E
					M20 conduit	802K-MSRS11B

Specifications

Certifications	cULus Listed and CE Marked for all applicable directives
Enclosure Type Rating	IP66
Ambient Temperature [C (F)]	-25...+80 ° (-18...+176 °)



Need Help?

The Rockwell Automation Support Center is your 24/7 support for the answers you need now.

<https://rok.auto/support>



Limit Switches

SENSORS

Operating Levers 802T and 802M

- Use with 802T, 802M, and 802MC limit switches
- Adjustable and non-adjustable levers
- Fork levers
- Offset levers
- Rod levers

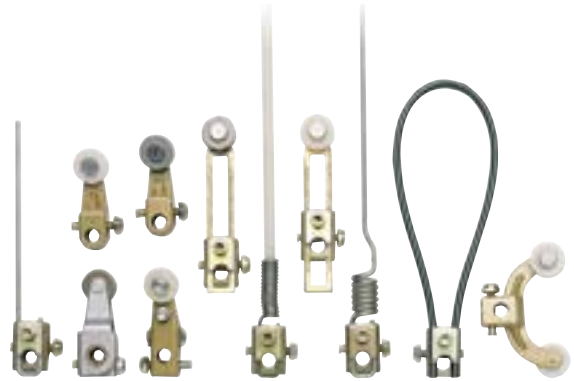

Roller Levers

For use with the 802T, 802M, & 802X switches

Description	Roller Material	Roller Diameter	Roller Width	Cat. No.
Non-adjustable cast-lever 1.5 in. radius roller on front	Nylon	19 (0.748)	7.11 (0.28)	802T-W1
	Nylon	19 (0.748)	25.4 (1.0)	802T-W1H
	Steel	19 (0.748)	6.35 (0.25)	802T-W1A
	Ball bearing	19 (0.748)	5.84 (0.229)	802T-W1B
Non-adjustable cast-lever 1.5 in. radius roller on rear	Nylon	19.05 (0.749)	25.4 (1)	802T-W1D
	Steel	19.05 (0.749)	6.35 (0.25)	802T-W1F
	Steel	19.05 (0.749)	19.05 (0.749)	802T-W1C
Adjustable lever 1.19...3 in. radius	Nylon	19.05 (0.749)	7.11 (0.28)	802T-W2
	Nylon	19.05 (0.749)	25.4 (1.0)	802T-W2D
	Nylon	38.1 (1.5)	7.11 (0.28)	802T-W2A
	Steel	19.05 (0.749)	6.35 (0.25)	802T-W2B
	Ball bearing	19.05 (0.749)	5.8 (0.228)	802T-W2C
Fork lever 1.5 in. radius	Steel; both rollers on front	19.05 (0.749)	6.35 (0.25)	802T-W4C
Micrometer adjustment lever 1.5 in. radius ¹	Nylon R.H. adjustable	19.05 (0.749)	7.11 (0.28)	802T-W6
	Steel R.H. adjustable	19.05 (0.749)	6.35 (0.25)	802T-W6A
Non-adjustable offset lever 1.44 in. radius roller on front	Steel	19.05 (0.749)	6.35 (0.25)	802T-W12A ²

Roller Levers

For use with the 802T, 802M, & 802X switches

Material	Rod Diameter [mm (in.)]	Cat. No.
Stainless steel rod, 5 in. long	3.3 (0.13)	802T-W3 ³
Stainless steel rod, 8.5 in. long	3.3 (0.13)	802T-W3B ³
Stainless steel rod, 11.5 in. long	3.3 (0.13)	802T-W3A
Stainless steel rod, 11.5 in. long	2.03 (0.08)	802T-W3F ⁴
Nylon rod, 12 in. long	6.35 (0.25)	802T-W3C
Stainless steel, 5 in. long	1.52 (0.06)	802T-W5 ³
Nylatron looped rod, 6 in. long, 2 in. wide loop	4.57 (0.18)	802T-W14

- ¹ The micrometer adjustment roller lever is designed especially for installations where the position of the roller is a critical factor. This lever has a pivoted roller which can be turned laterally. After clamping the lever to the switch shaft, the position of the roller can be precisely adjusted through an arc of 7.5° on either side of the center or straight-line position.
- ² When mounted on Plug-In devices, the offset lever provides equivalent cam tracking to the Non-Plug-In devices using catalog number 802T-W1 levers.
- ³ Recommended for use with low-operating-torque switches.
- ⁴ Not for use with catalog number 802M-NPY5 type switches.

Photoelectric Sensors



6-2...6-47

Proximity Sensors



6-48...6-77

Ultrasonic Sensors



6-78...6-81

Limit Switches



6-82...6-93

Encoders



6-94...6-101

Condition Sensing



6-102...6-111

Identification Devices



6-112...6-115



Replacement Operating Levers 802K and 440P

- Use with all 440P safety and 802K non-safety lever type limit switches
- Adjustable and non-adjustable levers
- Rod levers
- Spring rod levers
 - Short levers with wide roller
 - Telescopic arm levers

Operating Levers, Rods, Spring Rods and Telescopic Arms

For use with 802K and 440P limit switches

Description	Cat. No.
Levers	
Short lever with nylon roller for 440P-ASL ¹ or -AWL ¹	440P-WA1
Short lever with metal roller for 440P-ASL ¹ or -AWL ¹	440P-WA1A
Short lever with wide roller for 440P-ASL ¹ or -AWL ¹	440P-WA1B
Short lever with nylon roller for 440P-CSL ¹ or -CHM ¹	440P-WC1
Short lever with metal roller for 440P-CSL ¹ or -CHM ¹	440P-WC1A
Short lever with nylon roller for 802K-/440P-MSL ¹ or -MMH ¹	440P-WM1
Short lever with metal roller for 802K-/440P-MSL ¹ or -MMH ¹	440P-WM1A
Adjustable lever arm with nylon roller for 440P-AAL ¹ or -AA1L ¹	440P-WA2A
Adjustable lever arm with steel roller for 440P-AAL ¹ or -AA1L ¹	440P-WA2B
Adjustable lever with nylon roller for 440P-CAL ¹ , -CRR ¹ , -MRR ¹	440P-WC2
Adjustable lever with large rubber roller for 440P-CAL ¹ , -CRR ¹ , -MRR ¹	440P-WC2A
Adjustable lever with metal roller for 440P-CAL ¹ or -CRR ¹	440P-WC2B
Adjustable lever with nylon roller for 802K-/440P-MAL ¹ or -MRR ¹	440P-WM2
Adjustable lever with metal roller for 802K-/440P-MAL ¹ or -MRR ¹	440P-WM2A
Rods	
Adjustable metal rod for 802K-/440P-MAR ¹	440P-WM3
Spring Rods	
Metal spring rod for 802K-/440P-MSR ¹	440P-WM4
Telescopic Arms	
Telescopic arm for 802K-/440P-MTA ¹	440P-WM5

¹ Use these levers only with this catalog number.



Limit Switches

Compact, Precision and Small Precision 802B

- Rugged die-cast housings
- Industry standard dimensions
- Low trip and reset points (precision and small precision models)
- Wide range of options and operators



For When Bigger Switches Won't Fit

The 802B product line consists of different body styles: compact, precision, and small precision. Each style has been designed to withstand the rugged environments that industrial applications demand. The 802B family of limit switches can be mounted in areas that traditional NEMA limit switches can not, due to their size and mounting options.

Specifications

	802B Compact	Precision	Small Precision
Certifications	UL Listed, CSA Certified, and CE Marked for all applicable directives	UL Listed, CSA Certified, and CE Marked for all applicable directives	UL Listed, CSA Certified, and CE Marked for all applicable directives
Enclosure Type Rating	NEMA 1, 3, 4, 6, 12, 13 and IP67	Non-booted models: NEMA 1 and IP60 Booted models: NEMA 1, 3, 4, and IP65	NEMA 1, 3, 4, 6, 13 and IP67
Operating Temperature [C (F)]	-10...+70 ° (14...158 °)	-10...+80 ° (14...176 °)	-10...+80 ° (14...176 °)
Contact Type	SPDT form C	SPDT form C	SPDT form C
Mechanical Life	10 million operations		

Photoelectric Sensors



6-2...6-47

Proximity Sensors



6-48...6-77

Ultrasonic Sensors



6-78...6-81

Limit Switches



6-82...6-93

Encoders



6-94...6-101

Condition Sensing



6-102...6-111

Identification Devices



6-112...6-115

Product Selection

802B Compact



Head Type	Torque to Operate, Max. [N-m (lb-in.)]	Force to Operate [N (lb)]	Travel to Operate Contacts, Max.	Maximum Travel	Travel to Reset Contacts	Cat. No.
Rotary arm	0.216 (2)	-	25°	70°	3°	802B-CSAAXSXC3
Center rotary arm	0.216 (2)	-	10 ±3°	65°	4°	802B-CSAA2XSXC3
Wobble stick	0.118 (1.04)	-	15°	18° (Nominal Value)	11° (Nominal Value)	802B-CSACXSXC3
Top push booted head	-	17.65 (3.97)	1.8 mm (0.071 in.)	5 mm (0.197 in.)	0.2 mm (0.008 in.)	802B-CSABBSXC3
Top push roller booted head	-	17.65 (3.97)	1.8 mm (0.071 in.)	5 mm (0.197 in.)	0.2 mm (0.008 in.)	802B-CSADBSXC3
Top push cross roller booted head	-	17.65 (3.97)	1.8 mm (0.071 in.)	5 mm (0.197 in.)	0.2 mm (0.008 in.)	802B-CSAD1BSXC3
Top push panel mount	-	11.77 (2.65)	1.8 mm (0.071 in.)	5 mm (0.197 in.)	0.2 mm (0.008 in.)	802B-CPABXSXC3
Top push roller panel mount	-	11.77 (2.65)	1.8 mm (0.071 in.)	5 mm (0.197 in.)	0.2 mm (0.008 in.)	802B-CPADXSXC3
Top push cross roller panel mount	-	11.77 (2.65)	1.8 mm (0.071 in.)	5 mm (0.197 in.)	0.2 mm (0.008 in.)	802B-CPAD1XSXC3

Precision

Head Type	Force to Operate [N (lb)]	Travel to Operate Contacts, Max. [mm (in.)]	Maximum Travel [mm (in.)]	Travel to Reset Contacts [mm (in.)]	Mounting	Cat. No.
Top push	2.45...3.43 (0.55...0.77)	0.4 (0.016)	5.9 (0.232)	0.05 (0.002)	Side	802B-PSABXSX
Top push roller	2.45...3.43 (0.55...0.77)	0.5 (0.020)	4.1 (0.161)	0.05 (0.002)	Side	802B-PSADXSX
Roller lever	5.59 (1.28)	4 (0.157)	10 (0.394)	0.4 (0.016)	Side	802B-PSARXSX
Top push booted	7.85 (1.76)	2 (0.079)	7 (0.276)	0.1 (0.004)	Side	802B-PSABBSX
Top push roller booted	4.9 (1.09)	1 (0.039)	4.5 (0.177)	0.12 (0.005)	Side	802B-PSADBSX
Top push cross roller booted	4.9 (1.09)	1 (0.039)	4.5 (0.177)	0.12 (0.005)	Side	802B-PSAD1BSX
Roller lever booted	6.28 (1.40)	5 (0.197)	11 (0.433)	0.4 (0.016)	Side	802B-PSARBSX

Small Precision

Head Type	Force to Operate [N (lb)]	Travel to Operate Contacts, Max. [mm (in.)]	Maximum Travel [mm (in.)]	Travel to Reset Contacts [mm (in.)]	Mounting	Cat. No.
Top push	11.8 (2.65)	1.5 (0.059)	3.9 (0.154)	0.2 (0.008)	Side	802B-SSABXSX
Top push panel mount	11.8 (2.65)	1.5 (0.059)	4.5 (0.177)	0.2 (0.008)	Side	802B-SPABXSX
Top push roller panel mount	11.8 (2.65)	1.5 (0.059)	4.5 (0.177)	0.2 (0.008)	Side	802B-SPADXSX
Top push roller booted	6.86 (1.54)	1.5 (0.059)	4 (0.157)	0.2 (0.008)	Side	802B-SSADBSX
Short hinge lever	3.92 (0.88)	6.2 (0.244) ± 1.2	12.2 (0.480)	1 (0.04)	Side	802B-SSAH1XSX
Hinge lever	2.75 (0.62)	8.2 (0.323) ± 1.2	16.6 (0.645)	1.4 (0.055)	Side	802B-SSAHXSX
Short roller lever	3.92 (0.88)	6.2 (0.244) ± 1.2	12.2 (0.480)	1 (0.04)	Side	802B-SSAR1XSX
Roller lever	2.75 (0.62)	8.3 (0.327) ± 1.2	16.7 (0.657)	1.4 (0.055)	Side	802B-SSARXSX



Encoders

SENSORS

EtherNet/IP 842E

- EtherNet/IP Interface
- Single- and multi-turn
- Status indication LEDs
- Easy integration and setup in Studio 5000 Logix Designer®
- Fully compliant CIP sync and CIP motion support (842E-CM)
- Endless shaft
- Flash upgradable



Integrated Motion on EtherNet/IP

EtherNet/IP uses CIP Sync and CIP Motion technologies to provide real-time, closed loop motion on standard Ethernet. This topology-independent network provides a simplified integration of the entire control solution on one network, including HMI, PAC, IO, and Motion Control.



Which version meets your application?

Velocity or Position Control
842E-¹



Position/Servo Control
842E-CM-¹



- Use the EtherNet/IP Encoder
- Provides position and velocity back to the Logix controller on EtherNet/IP
- Ideal applications: standard VFD drives

- Use the Integrated Motion on EtherNet/IP Encoder for servo applications
- Ideal applications: Kinetix® 5500 Servo drive applications that require auxiliary feedback or master half axis for gearing/camming applications

¹ Please see Product Selection on page 6-95 for complete catalog numbers.

Photoelectric
Sensors



6-2...6-47

Proximity
Sensors



6-48...6-77

Ultrasonic
Sensors



6-78...6-81

Limit
Switches



6-82...6-93

Encoders



6-94...6-101

Condition
Sensing



6-102...6-111

Identification
Devices



6-112...6-115

Product Selection

842E EtherNet/IP

Description	Single-/Multi-turn	Shaft Size/Type	Power Supply	Resolution	Connector Type	Cat. No.
EtherNet/IP Encoder	Single-turn	Solid shaft 10 mm with flat	10...30V DC	18 bit	M12	842E-SIP4BA
		Solid shaft 3/8 in. with flat				842E-SIP2BA
		Hollow shaft 15 mm				842E-SIP12BA
	Multi-turn	Solid shaft 10 mm with flat		842E-MIP4BA		
		Solid shaft 3/8 in. with flat		842E-MIP2BA		
		Hollow shaft 1/2 in.		842E-MIP10BA		
CIP Motion Encoder EIP	Single-turn	Solid shaft 3/8 in. with flat	18 bit	M12	842E-CM-SIP2BA	
		Solid shaft 3/8 in. with flat			842E-CM-SIP1BA	
		Hollow shaft 1/2 in.			842E-CM-SIP10BA	
	Multi-turn	Solid shaft 10 mm with flat	842E-CM-MIP4BA			
		Solid shaft 3/8 in. with flat	842E-CM-MIP2BA			
		Hollow shaft 1/2 in.	842E-CM-MIP10BA			

Specifications

Transmission Rate	10/100 MBit/s
Code Type	Binary
Operating Voltage Range	10...30V
No. of Revolutions, Max.	4,096 (12 Bit)
Operating Speed	9,000 RPM (solid shaft), max. 6,000 RPM (blind hollow shaft), max.
Shaft Loading	Radial: 80 N max. (solid shaft) Axial: 40 N max. (solid shaft)
Housing Material	Aluminum
Shaft Material	Stainless steel
Operating Temperature [C (F)]	-30...+85 ° (-22...+185 °)
Enclosure Type Rating ¹	IP65 (shaft); IP67 (housing)
Certifications	CE Marked for all applicable directives

¹ With mating connector inserted.

Required Cordsets and Accessories

Description	Cat. No.
Flexible coupling	845-CA-C-25
Flexible coupling	845-FC-B-B
842E Hollow shaft encoder clamp ring	845-MB-10
842E Hollow shaft encoder 2-point stator coupling	845-MB-11
842E square face mount flange, 63 mm	845-MB-12
DC Micro QD cordset (flying leads), straight, 4-pin, 2 m (6.5 ft)	889D-F4AC-2
M12 D-code patchcord, straight, male/male, 2 m (6.5 ft)	1585D-M4TBDM-2
M12 to RJ45 patchcord, male/male, 2 m (6.5 ft)	1585D-M4TBJM-2
M12 D-code patchcord, straight, male/male (shielded), 2 m (6.5 ft)	1585D-M4UBDM-2
M12 to RJ45 patchcord (shielded), male/male, 2 m (6.5 ft)	1585D-M4UBJM-2



Encoders

Sine Cosine/Serial 842HR

- Absolute feedback for position control
- High resolution incremental feedback for speed control
- Sine/Cosine differential interface
- Digital bi-directional RS-485 interface
- Compatible with Hiperface interface
- Internal diagnostic functions



Replace Multiple Encoders with a Single 842HR Encoder

Today's high performance digital servo drive systems require absolute feedback for position control and high resolution incremental feedback for speed control. Conventional systems use multiple incremental and absolute encoders to achieve this. The Allen-Bradley® 842HR Sine/Cosine encoder combines the advantages of incremental and absolute encoder technologies in a single, standalone unit targeted for high performance digital servo drive systems.



Ideal Applications

Compatible with a variety of motor control products including Kinetix drives and the Allen-Bradley Guardmaster® MSR57 safe speed monitoring relay, the 842HR is a flexible solution for wide range of industrial applications.

Single- Versus Multi-turn

In a single-turn encoder, absolute position retention on one full rotation of the encoder is provided. Multi-turn encoders provide absolute position on multiple turns of the encoder shaft (better for linear applications).

Photoelectric
Sensors



6-2...6-47

Proximity
Sensors



6-48...6-77

Ultrasonic
Sensors



6-78...6-81

Limit
Switches



6-82...6-93

Encoders

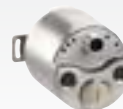

6-94...6-101

Condition
Sensing



6-102...6-111

Identification
Devices



6-112...6-115

Product Selection

Sine Cosine/Serial

Single-/Multi-turn	Shaft Size/Type	Power Supply	Resolution	Connector Type and Pinout	Cat. No.
Single-turn	Solid shaft 3/8 in. with flat	5...12V DC	15 bit	MS & 10-pin	842HR-SJDN115FWY2
					842HR-SJDZ115FWY2
Multi-turn	Solid shaft 3/8 in. with flat			M23 & 17-pin	842HR-SJDZ115FWYD
					842HR-MJDZ115FWYD
	Hub shaft 15 mm			MS & 10-pin	842HR-MJA1115FWY2
	Solid shaft 3/8 in. with flat			M23 & 17-pin	842HR-MJDN115FWYD



Looking for More?
 This catalog highlights only our most essential components; for a complete product selection, visit us at:
<https://rok.auto/directory>

Specifications

Sine/Cosine	1024 cycles per revolution
Code Type	Binary
No. of Revolutions	4,096 (12 Bit), max.
Operating Speed	6,000 RPM, max.
Shaft Loading	Radial: 35 lb, max.
	Axial: 40 lb, max.
Housing Material	Aluminum
Shaft Material	Stainless steel
Operating Temperature [C (F)]	-20...+85 ° (-4...+185 °)
Enclosure Type Rating ¹	IP66
Certifications	CE Marked for all applicable directives

¹ With mating connector inserted.

Required Cordsets and Accessories

Description	Cat. No.
Pre-wired cable for 17-pin connector	2090-XXNFMF-S⊗
10-pin encoder cable assembly	845-CA-C-10
3/8 in. bore flex coupling	845-FC-B-B
Tether	842HR
Mounting Bracket	845-MB-15

⊗ The catalog number as listed is incomplete. Replace ⊗ with **1, 2, 3, 4, 5, 7, 9, 12, 15, 20, 25, or 30** for available lengths in meters.



Encoders

SENSORS

CIP Safety with EtherNet/IP Encoder 843ES

- Rated up to and including
 - SIL 3 according to IEC 61800-5-2, IEC 620261, and IEC 61508-1
 - PLe, Cat. 3, according to ISO 13849-1
- Solid and hollow shafts available
- Dual Ethernet ports with embedded EtherNet/IP switch for linear networks and Device Level Ring topologies
- IP67 washdown rating
- 15-bit safety resolution, 18-bit standard resolution
- 12-bit multi-turn resolution



EtherNet/IP

The first and only encoder on the market featuring CIP Safety over EtherNet/IP up to – and including – SIL 3/PLe safety applications

Networked safety solutions provide the ability to simplify your machine design and minimize equipment redundancies. Fewer components mean smaller panel enclosures which helps reduce machine footprint.

Benefits of Controller-based Safety/Integrated Safety

- A single GuardLogix® controller manages both safety and standard control
- Complete safety function integration within one software environment – Studio 5000 Logix Designer®
- Improved visibility to all machine events – including safety events
- Reduced complexity and rich diagnostic data
- Simplified zoning and reduced changeover time
- Integrated or hardwired safety – Safe Torque-Off – SIL3 PLe
- Advanced safety with five safe stop functions and three safe monitoring functions
- Safety and standard control share the same EtherNet/IP network

Integrated Safety Solutions for AC and servo drives

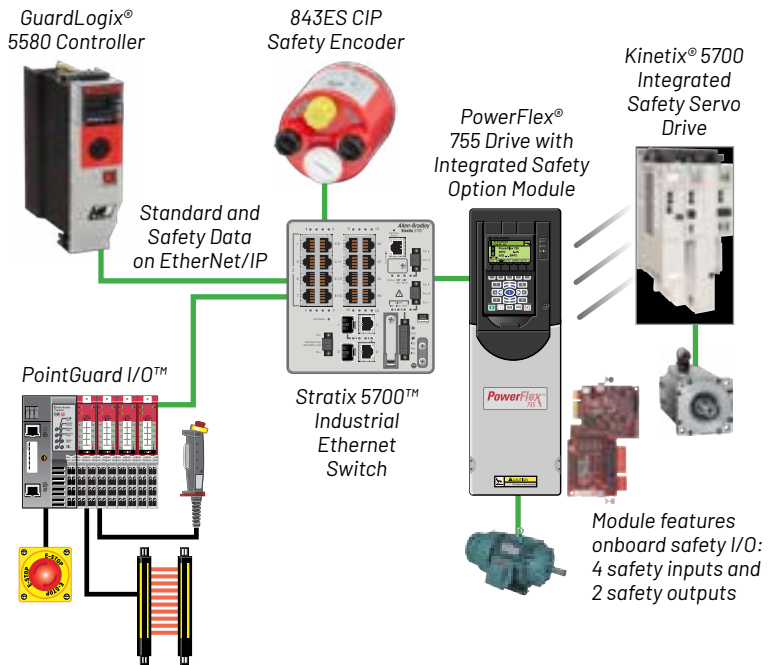

Photoelectric Sensors



6-2...6-47

Proximity Sensors



6-48...6-77

Ultrasonic Sensors



6-78...6-81

Limit Switches



6-82...6-93

Encoders



6-94...6-101

Condition Sensing



6-102...6-111

Identification Devices



6-112...6-115

Encoders

SENSORS

General Purpose and Compact Incremental 847H and 847T

- 847H: General purpose, 2.5 in. diameter
847T: Compact, 2 in. diameter
- Resolution up to 65536 ppr
- Various output configurations, mounting options, and shaft sizes
- Cable, M12, and military-style connections
- Zero set input option



The General Purpose Encoder Family

Use the 847 incremental encoder for general purpose auxiliary feedback for a variety of configurable options. Ideal for machine tools, packaging machinery, motion control, and robotics.

847T



Square Flange

847H



Easy servo flange mount

847T-PY



2.5 in. with Bell housing and coupler, to protect encoder from damage and contamination

Photoelectric Sensors



6-2...6-47

Proximity Sensors



6-48...6-77

Ultrasonic Sensors



6-78...6-81

Limit Switches



6-82...6-93

Encoders



6-94...6-101

Condition Sensing



6-102...6-111

Identification Devices



6-112...6-115

Product Selection

General Purpose and Compact Incremental

Mounting Configuration	Shaft Size	Power Supply	Output Configuration	Connector/ Cable Exit	Connector Type & Pinout	Cat. No. ¹
Standard square flange	3/8 in. diameter shaft with flat	4.5...5.5V DC	4.5...5.5V DC Line Driver Outputs (TTL)	Radial Exit	MS & 10-pin	847H-DN1A-RH01024
Standard servo mount		8...30V DC			M12 & 8-pin with mating connector ²	847H-HN2A-RA01024
Standard square flange	10 mm diameter shaft with flat	4.5...5.5V DC	8...30V Line Driver Outputs (HTL)		MS & 6-pin with mating connector	847T-DL2C-RC01024
	3/8 in. diameter shaft with flat	4.5...5.5V DC	4.5...5.5V DC Line Driver Outputs (TTL)		MS & 10-pin with mating connector	847T-DN1A-RG01024
		8...30V DC	4.5...5.5V DC Line Driver Outputs (TTL)		MS & 10-pin	847T-DN2A-RH01024
			8...30V Line Driver Outputs (HTL)		MS & 6-pin	847T-DN2C-RD01024
5PY mounting	5/8 in. diameter extended shaft with flat	8...30V DC	8...30V Line Driver Outputs (HTL)		M12 & 8-pin with mating connector ²	847T-PY2C-RA01024

¹ Replace **01024** (revolution) with **1...65536** for optional revolutions.

² 8-pin M12 connector is now available for all models.

Specifications

Revolutions	1...65536 CPR (16 bit)
Code Type	Incremental, 2 channels with zero index
Angular Acceleration	500,000 radians/sec ²
Operating Speed	9,000 RPM, max.
Shaft Loading	80 N radial
Housing Material	Aluminum
Shaft Material	Stainless steel
Operating Temperature [C (F)]	-30...+80 ° (-22...+176 °)
Enclosure Type Rating 3	IP67 housing, shaft seal IP65
Certifications	CE Marked for all applicable directives

³ With mating connector inserted.

Required Cordsets and Accessories

Description	Cat. No.
DC Micro M12 QD cordset, straight, 8-pin, 2 m (6.5 ft)	889D-F8FB-2 ⁴
6-pin encoder cable assembly	845-CA-A-10
7-pin encoder cable assembly	845-CA-B-10
10-pin encoder cable assembly	845-CA-C-10 ⁵
Flexible coupling	845-FC-B-B
Flexible coupling	845-CA-C-2 ⁵

⁴ Replace **2** with **5** or **10** for other standard cable lengths in meters.

⁵ Replace **10** with **25, 50, 100, 200,** or **330** for standard cable lengths in feet.

Sales Offices and Distributors

Our network of sales offices and distributors offers exceptional knowledge and service to help you design, implement and support your automation investment.

<https://rok.auto/buy>



Condition Sensing

SENSORS

Integrated Condition Monitoring System Dynamix™ 1444

- Machinery protection and condition monitoring of rotating and reciprocating assets
- Distributed I/O on Ethernet/IP
- Easy integration and setup in Studio 5000 Logix Designer®
- Rugged, conformally coated and approved for electrical safety and hazardous areas
- Expansion modules available for additional capabilities



Enable Smart Machine strategy with the Dynamix 1444 series

Don't let unplanned downtime impact your manufacturing objectives. The Dynamix 1444 series provides a distributed solution for protecting or monitoring the condition of your critical machinery. The dynamic measurement module can support dynamic and static measurements to realize the benefits of a condition based maintenance or a predictive maintenance program. As a part of the Rockwell Automation's Integrated Architecture, other system components such as controllers, visualization products, other input/output products, and more can be easily applied to meet the specific needs of the application.

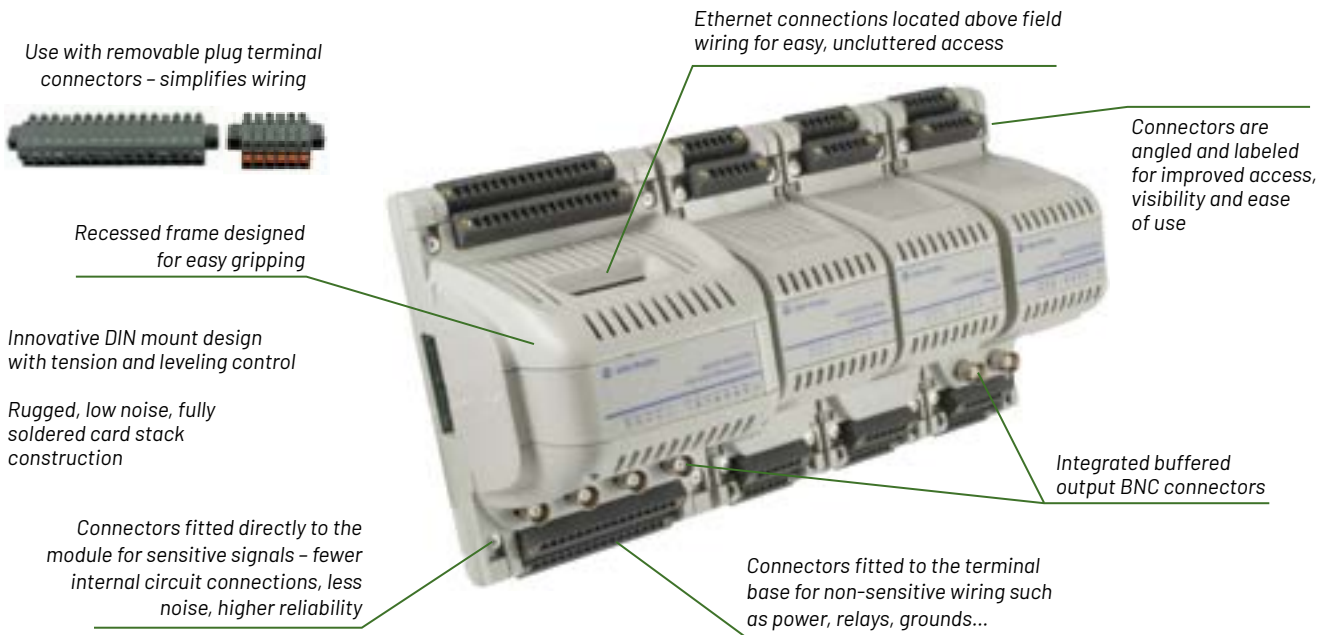

Photoelectric Sensors



6-2...6-47

Proximity Sensors



6-48...6-77

Ultrasonic Sensors



6-78...6-81

Limit Switches



6-82...6-93

Encoders



6-94...6-101

Condition Sensing



6-102...6-111

Identification Devices



6-112...6-115

Product Selection

Integrated Condition Monitoring

Type	Module	Cat. No.
Measurement modules	Dynamic measurement module	1444-DYN04-01RA
Speed modules	Tachometer signal conditioner expansion module	1444-TSCX02-02RB
Relay modules	Relay expansion module	1444-RELX00-04RB
Analog output modules	4...20 mA expansion module	1444-AOFX00-04RB
Terminal bases	Dynamic measurement module terminal base	1444-TB-A
	Expansion module terminal base	1444-TB-B

Removable Plug Connector Sets

Module	Spring Connector	Screw Connector
1444-DYN04-01RA	1444-DYN-RPC-SPR-01	1444-DYN-RPC-SCW-01
1444-TSCX02-02RB	1444-TSC-RPC-SPR-01	1444-TSC-RPC-SCW-01
1444-RELX00-04RB	1444-REL-RPC-SPR-01	1444-REL-RPC-SCW-01
1444-AOFX00-04RB	1444-AOF-RPC-SPR-01	1444-AOF-RPC-SCW-01
Terminal Base		
1444-TB-A	1444-TBA-RPC-SPR-01	1444-TBA-RPC-SCW-01
1444-TB-B	1444-TBB-RPC-SPR-01	1444-TBB-RPC-SCW-01 21

Specifications

Certifications	c-UL-us and CE marked for all applicable directives			
	<table border="0"> <tr> <td style="vertical-align: top;">Ex</td> <td> European Union 94/9/EC ATEX Directive, compliant with: <ul style="list-style-type: none"> • EN 60079-15; Potentially Explosive Atmospheres, Protection “n” • EN 60079-0; General Requirements • II 3 G Ex N/A IIC T4 Gc • II 3 G Ex N/A nC IIC T4 Gc (only 1444-DYN04-01RA and 1444-RELX00-04RB) • DEMK014ATEX1365X </td> </tr> <tr> <td style="vertical-align: top;">IECEx</td> <td> IECEx System, compliant with: <ul style="list-style-type: none"> • IEC 60079-15; Potentially Explosive Atmospheres, Protection “n” • IEC 60079-0; General Requirements • II 3 G Ex N/A IIC T4 Gc • II 3 G Ex N/A nC IIC T4 Gc (only 1444-DYN04-01RA and 1444-RELX00-04RB) • IECEx UL 14.0082X </td> </tr> </table>	Ex	European Union 94/9/EC ATEX Directive, compliant with: <ul style="list-style-type: none"> • EN 60079-15; Potentially Explosive Atmospheres, Protection “n” • EN 60079-0; General Requirements • II 3 G Ex N/A IIC T4 Gc • II 3 G Ex N/A nC IIC T4 Gc (only 1444-DYN04-01RA and 1444-RELX00-04RB) • DEMK014ATEX1365X 	IECEx
Ex	European Union 94/9/EC ATEX Directive, compliant with: <ul style="list-style-type: none"> • EN 60079-15; Potentially Explosive Atmospheres, Protection “n” • EN 60079-0; General Requirements • II 3 G Ex N/A IIC T4 Gc • II 3 G Ex N/A nC IIC T4 Gc (only 1444-DYN04-01RA and 1444-RELX00-04RB) • DEMK014ATEX1365X 			
IECEx	IECEx System, compliant with: <ul style="list-style-type: none"> • IEC 60079-15; Potentially Explosive Atmospheres, Protection “n” • IEC 60079-0; General Requirements • II 3 G Ex N/A IIC T4 Gc • II 3 G Ex N/A nC IIC T4 Gc (only 1444-DYN04-01RA and 1444-RELX00-04RB) • IECEx UL 14.0082X 			
Operating temperature	-25...70 °C (-13...158 °F)			
Relative humidity	5...95% noncondensing			
Vibration	2 g @ 10...500 Hz			
Enclosure type rating	None (open style)			
Voltage	Limited Voltage Source ATEX/IECEx: 18...32V, max 8 A SELV/PELV Source			
Operating shock	15 g			



Condition Sensing

SENSORS

Solid-State Pressure Sensors 836P

Display

- -1...551 bar (-14.5 psi to 8,000 psi)
- Rotatable housing (320°) and head (330°)
- IO-Link enabled

Non-Display

- -1...689 bar (-30 in. Hg to 10,000 psi)
- Multiple process connections available
- IP67 enclosure rating



Accurate and Reliable with Quick Response Time

High-accuracy, new technology, and rigid standards have combined to manufacture the Solid-State 836P Pressure Sensors, available in display and non-display models in rugged, compact housings with corrosion-resistant 316L solid-state sensor elements.

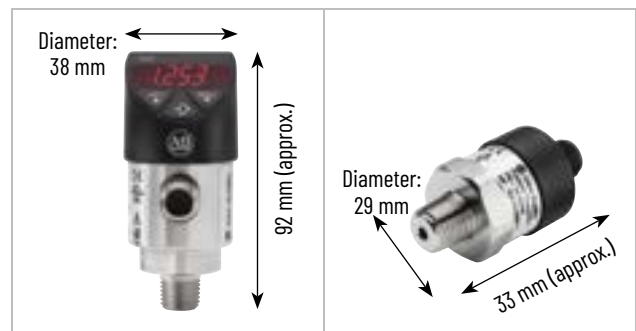

Sensor Model	Standard	✓	✓
	Flush Mount	✓	
	Hygienic	✓	
Pressure Range Bar (psi)	-1 to 20 (-14.5 to 300)	✓	✓
	0 to 550 (0 to 8,000)	✓	
	0 to 689 (0 to 10,000)		✓
Process Connection	NPT (male/female)	✓	✓
	G BSPP (male/female)	✓	✓
	SAE (male)	✓	✓
	Sanitary	✓	
Pressure Type	Vacuum	✓	✓
	Absolute	✓	✓
	Gauge	✓	✓
Output Type	2 x PNP, IO-Link	✓	
	1 x PNP + 1 x Analog (4...20 mA), IO-Link	✓	
	Analog (4...20 mA)		✓
Connection Style	4 Pin DC Micro (M12) Integral QD	✓	✓

Photoelectric Sensors



6-2...6-47

Proximity Sensors



6-48...6-77

Ultrasonic Sensors



6-78...6-81

Limit Switches



6-82...6-93

Encoders

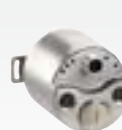

6-94...6-101

Condition Sensing























6-102...6-111

Identification Devices



6-112...6-115

Product Selection

	Lower Pressure Range Bar (psi) ¹	Pressure Type	Process Connection ¹	Output Type	Catalog No.	
 <p>Flush Mount and Hygienic options are also available</p>	-1...1 (-14.5...14.5)	Gauge ²	1/4" NPT female	2 x PNP	836P-D1NFGA14PP-D4 	
	-1...10 (-14.5...145)		1/4" NPT female	1 x PNP + 1 analog (4...20 mA)	836P-D1NFGA14PA-D4 	
			1/4" NPT male	1 x PNP + 1 analog (4...20 mA)	836P-D1NMG14PA-D4 	
			6 1/4" BSPP male	1 x PNP + 1 analog (4...20 mA)	836P-D1MG14PA-D4 	
			1/4" NPT female	2 x PNP	836P-D2NFGA14PP-D4 	
	0...1 (0...14.5)		Gauge ²	1/4" NPT female	1 x PNP + 1 analog (4...20 mA)	836P-D2NFGA14PA-D4 
	0...2.5 (0...36.2)			1/4" NPT female	2 x PNP	836P-D2NFGA36PP-D4 
				1/4" NPT female	1 x PNP + 1 analog (4...20 mA)	836P-D2NFGA36PA-D4 
	0...25 (0...362)			1/4" NPT female	2 x PNP	836P-D2NFG36PP-D4 
				1/4" NPT female	1 x PNP + 1 analog (4...20 mA)	836P-D2NFG36PA-D4 
				1/4" NPT male	1 x PNP + 1 analog (4...20 mA)	836P-D2NMG36PA-D4 
				6 1/4" BSPP female	1 x PNP + 1 analog (4...20 mA)	836P-D2GFG36PA-D4 
	0...100 (0...1450)			1/4" NPT female	2 x PNP	836P-D2NFGC14PP-D4 
				1/4" NPT female	1 x PNP + 1 analog (4...20 mA)	836P-D2NFGC14PA-D4 
0...248 (0...3600)	1/4" NPT female	2 x PNP		836P-D2NFGC36PP-D4 		
0...400 (0...5800)	1/4" NPT female	1 x PNP + 1 analog (4...20 mA)		836P-D2NFGC36PA-D4 		
	1/4" NPT female	2 x PNP		836P-D2NFGC58PP-D4 		
	1/4" NPT female	1 x PNP + 1 analog (4...20 mA)		836P-D2NFGC58PA-D4 		
	-1.01...10 (-30 in. Hg...145)	Gauge ²		1/4" NPT male	Analog (4...20mA)	836P-N3NMG14A-D4
	0...1 (0...14.5)		1/4" NPT female	836P-N3NFG14A-D4		
			1/4" NPT male	836P-N2NMG14A-D4		
	0...2 (0...30)		1/4" NPT male	836P-N2NMG30A-D4		
			1/4" NPT female	836P-N2NFG30A-D4		
	0...6.89 (0...100)		1/4" NPT male	836P-N2NMG10A-D4		
			1/4" NPT female	836P-N2NFG10A-D4		
	0...10 (0...145)		1/4" NPT male	836P-N2NMG14A-D4		
			1/4" NPT female	836P-N2NFG14A-D4		
	0...34 (0...500)		1/4" NPT male	836P-N2NMG50A-D4		
	0...68 (0...1000)		1/4" NPT male	836P-N2NMG10A-D4		
	0...206 (0...3000)		1/4" NPT male	836P-N2NMG30A-D4		
	0...344 (0...5000)		1/4" NPT male	836P-N2NMG50A-D4		

836P- Pressure Sensor Accessories

Description	Catalog No.
M12 x 1 Connector	889D-F4AC-2
M12 x 1 Right-angle connector	889D-R4AC-2
IO-Link Master Module for POINT I/O™	1734-4IOL
POINT I/O EtherNet/IP Adapter Module	1734-AENTR (dual-port Ethernet) ³
POINT I/O EtherNet/IP Adapter Module	1734 AENT (single Ethernet port) ³
ArmorBlock IO-Link Master	1732E-8IOLM12R

 IO-Link enabled.

- ¹ For additional pressure ranges and process connections configurations, please visit <https://rok.auto/directory>.
- ² Absolute pressure models also available.
- ³ Compatible only with Series B, firmware version 5.012 or later.
- ⁴ Hygienic and flush mount models available.

For more information on our complete family of condition sensing products, please visit:
<https://rok.auto/condition-sensors>



Condition Sensing

SENSORS

Solid-State Temperature Switches 837T, 837RTD

Display

- Temperature range: -20...80 °C (-4...176 °F)
- Large visual display rotates 180°

Non-display

- Temperature range: -50...250 °C (-58...482 °F)
- IP67, IP69K enclosure ratings

Resistance Temperature Detector

- Temperature range:
-50...200 °C (-58...392 °F)
- Pt100, Pt1000 measuring elements



A Compact, Comprehensive Solution

Built with high-accuracy and new technology, 837T and 837RTD solid-state switches provide users with a comprehensive solution for measuring temperatures in liquids, gases and vapors.

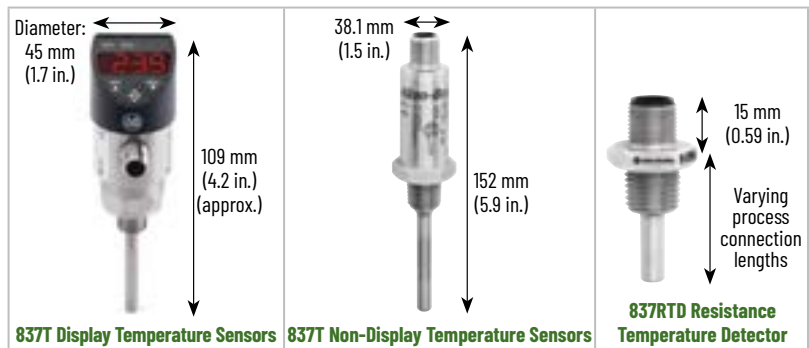

Sensor Model	Standard	837T Display Temperature Sensors	837T Non-Display Temperature Sensors	837RTD Resistance Temperature Detector
Hygienic		✓	✓	
Temperature Range °C (°F)	-20... 80 (-4 ... 176)	✓		
	-50... 150 (-58...302)		✓	
	-50...250 (-58...482)		✓	
	-30... 130 (-22...266)			✓
	-50... 200 (-58...392)			✓
Process Connection	1/4 NPT Male	✓	✓	✓
	1/2 NPT Male	✓		
	G 1/4 BSPP Male	✓	✓	✓
	G 1/2 BSPP Male	✓	✓	
	Sanitary		✓	
Probe Length	22 mm to 250 mm			✓
	25 mm to 400 mm	✓	✓	
Output Type	2 x PNP / 1 x PNP + 1 x Analog (4...20 mA)	✓		
	Analog (4...20 mA)	✓	✓	
	2 x PNP, IO-Link	✓		
	Pt100, Pt1000			✓
Connection Style	4-Pin DC Micro (M12) QD	✓	✓	✓

Photoelectric Sensors



6-2...6-47

Proximity Sensors



6-48...6-77

Ultrasonic Sensors



6-78...6-81

Limit Switches



6-82...6-93

Encoders

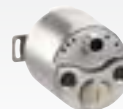

6-94...6-101

Condition Sensing



6-102...6-111



Identification Devices



6-112...6-115

Product Selection

837T Display Model

	Process Connection	Probe Length mm (inch)	Temperature Range °C (°F)	Catalog No.		
				Output: 2 x PNP	Output: 1 PNP + 1 Analog 4...20...mA	
	1/4" NPT Male	25 (0.98)	-20...80 (-4...178)	837T-D3N14A25PP-D4	837T-D3N14A25PA-D4	
		50 (1.96)		837T-D3N14A50PP-D4	837T-D3N14A50PA-D4	
		100 (3.93)		837T-D3N14B10PP-D4	837T-D3N14B10PA-D4	
		150 (5.9)		837T-D3N14B15PP-D4	837T-D3N14B15PA-D4	
		250 (9.84)		837T-D3N14B25PP-D4	837T-D3N14B25PA-D4	
		350 (13.7)		837T-D3N14B35PP-D4	837T-D3N14B35PA-D4	
		25 (0.98)		837T-D3N12A25PP-D4	837T-D3N12A25PA-D4	
	1/2" NPT Male	50 (1.96)		837T-D3N12A50PP-D4	837T-D3N12A50PA-D4	
		100 (3.93)		837T-D3N12B10PP-D4	837T-D3N12B10PA-D4	
		150 (5.9)		837T-D3N12B15PP-D4	837T-D3N12B15PA-D4	
		250 (9.84)		837T-D3N12B25PP-D4	837T-D3N12B25PA-D4	
		25 (0.98)		837T-N1N14A25A-D4		
		50 (1.96)		837T-N1N14A50A-D4		
		100 (3.93)		837T-N1N14B10A-D4		
 <p>Hygienic option is also available</p>	1/4" NPT Male	150 (5.9)	Standard -50...150 (-58...302)	837T-N1N14B15A-D4		
		250 (9.84)		837T-N1N14B25A-D4		
		300 (11.81)		837T-N1N14B30A-D4		
		350 (13.7)		837T-N1N14B35A-D4		
		400 (15.75)		837T-N1N14B40A-D4		
		25 (0.98)		837T-N2N14A25A-D4		
		50 (1.96)		837T-N2N14A50A-D4		
	Extended Range	100 (3.93)		-50...250 (-58...482)	837T-N2N14B10A-D4	
		150 (5.9)			837T-N2N14B15A-D4	
		250 (9.84)			837T-N2N14B25A-D4	
		300 (11.81)			837T-N2N14B30A-D4	
		350 (13.7)			837T-N2N14B35A-D4	
		400 (15.75)			837T-N2N14B40A-D4	
					1/4" NPT Male	28 (1.1)
30 (1.18)	837RTD-N1N14A30P1-D4					
40 (1.57)	837RTD-N1N14A40P1-D4					
50 (1.97)	837RTD-N1N14A50P1-D4					
60 (2.36)	837RTD-N1N14A60P1-D4					
65 (2.56)	837RTD-N1N14A65P1-D4					
28 (1.1)	Extended Range -50...200 (-58...392)		837RTD-N2N14A28P1-D4			
30 (1.18)			837RTD-N2N14A30P1-D4			
40 (1.57)			837RTD-N2N14A40P1-D4			
50 (1.97)			837RTD-N2N14A50P1-D4			
60 (2.36)			837RTD-N2N14A60P1-D4			
65 (2.56)			837RTD-N2N14A65P1-D4			
Resistance Output						

☑ IO-Link enabled.

Note: IO-Link Master Module (Catalog No. 1734-4I01 or 1732E-8IOLM12R) is required for premier IO-Link integration experience.

837T Temperature Sensor Accessories

Description	Catalog No.
DC Micro (M12) QD cordset, straight, 4-pin, 2 m (6.5 ft)	889D-F4AC-2
DC Micro (M12) QD cordset, right angle, 4-pin, 2 m (6.5 ft)	889D-R4AC-2
IO-Link Master Module for POINT I/O™	1734-4IOL
ArmorBlock IP67 IO-Link Master	1732E-8IOLM12R



Condition Sensing

SENSORS

Solid-State Flow Switches 839E

- Flow rates from 0.03...3 m/s
- Rugged, corrosion-resistant stainless steel housing, and sensing element
- RTD sensor technology
- Calorimetric measurement principle
- Independently programmable dual N.O./N.C. PNP outputs or 4...20 mA analog output with single PNP output
- Operation and visualization via PC using ReadWin 2000 software



Flow Sensors for the Harshest Environments

Allen-Bradley 839E solid-state flow sensors are used for process and industrial automation applications. Rockwell Automation sensors can be found in food and beverage, pharmaceuticals, water and waste water plants, and hydraulic applications.

These sensors are capable of measuring the liquid flow rate from 0.03 m/s to 3 m/s. The flow rate is displayed as a percentage of flow rate. For example at no flow the display will read 0%. The sensor probe is designed using 316L stainless steel probe and is resistant to aggressive media and capable of withstanding corrosive liquids.

Technology

Allen-Bradley flow switches are based on the calorimetric principle. The 839E sensors incorporate a heated temperature element; as media flows passed the sensor heat is removed due to convection. The amount of heat transfer is dependent on the flow velocity of the medium and the temperature difference between the sensor and the medium.

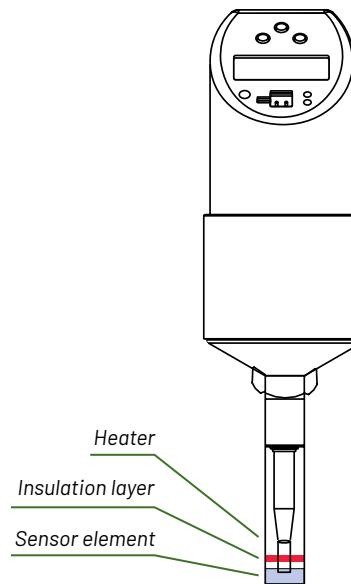

Photoelectric
Sensors



6-2...6-47

Proximity
Sensors



6-48...6-77

Ultrasonic
Sensors



6-78...6-81

Limit
Switches



6-82...6-93

Encoders



6-94...6-101

Condition
Sensing



6-102...6-111

Identification
Devices



6-112...6-115

Product Selection

839E Solid-State Flow Switches

Process Connection	Probe Length [mm (in.)]	Display	Output	Cat. No.
1/4 in. NPT (male)	30 (1.18)	Yes	Dual PNP N.O./N.C. programmable	839E-DA1BN1A3D4
	100 (3.93)			839E-DA1BN1A2D4
	30 (1.18)		4...20 mA + 1 PNP	839E-DC1BN1A3D4
	100 (3.93)			839E-DC1BN1A2D4
1/2 in. NPT (male)	30 (1.18)		Dual PNP N.O./N.C. programmable	839E-DA1BN2A3D4
	100 (3.93)			839E-DA1BN2A2D4
	30 (1.18)		4...20 mA + 1 PNP	839E-DC1BN2A3D4
	100 (3.93)			839E-DC1BN2A2D4
G 1/4 BSPP	30 (1.18)		Dual PNP N.O./N.C. programmable	839E-DA1BN3A3D4
	100 (3.93)			839E-DA1BN3A2D4
	30 (1.18)		4...20 mA + 1 PNP	839E-DC1BN3A3D4
	100 (3.93)			839E-DC1BN3A2D4
G 1/2 BSPP	30 (1.18)		Dual PNP N.O./N.C. programmable	839E-DA1BN4A3D4
	100 (3.93)			839E-DA1BN4A2D4
	30 (1.18)		4...20 mA + 1 PNP	839E-DC1BN4A3D4
	100 (3.93)			839E-DC1BN4A2D4

Specifications

Certifications	cULus Listed and CE Marked for all applicable directives, and 3 A authorized only with sanitary adaptor
Enclosure Type Rating	IP66
Operating Range	Liquids from 0.03...3 m/s (0.1... 9.84 ft/s) Mass flow as a relative value between 0 and 100%
Media Temperature [C (F)]	-20...+85 ° (-4...+185 °)
Operating Voltage	18...30V DC, < 100 mA
Load Current, Max.	250 mA
Housing Material	316L stainless steel

Required Cordsets and Accessories

Description	Cat. No.
DC Micro QD cordset, straight, 4-pin, 2 m (6.5 ft)	889D-F4AC-2
Configuration Kit (includes converter cable and ReadWin 2000 software)	836E-NSR



Condition Sensing

SENSORS

Solid-State Level Switches 840E

- Piezoelectric effect technology
- Rugged, corrosion-resistant stainless steel housing and sensing element
- DC Micro (M12) and DIN valve connection types
- Highly-visible status LED for process monitoring
- Complementary N.O./N.C. outputs
- Operation independent of the medium properties – build up, changing media, turbulence, air bubbles, foam, and vibration



Reliable Level Detection Regardless of Media Characteristics

Allen-Bradley level sensors are a quick and easy solution for applications requiring point level detection. These sensors have been applied in applications such as liquid level monitoring in tanks, containers, and pipes.

The 840E stainless steel liquid level sensors are capable of detecting corrosive liquid media and operate independently of the media properties such as liquid build up on the forks, change of media structure, turbulence, foam or air bubbles as well as plant vibrations.

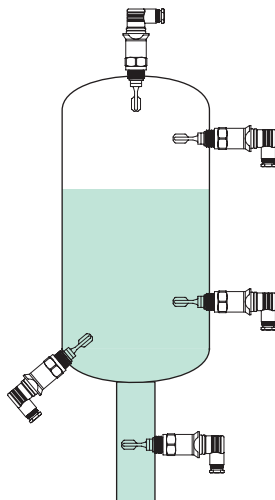

Technology

The 840E switch uses piezoelectric effect technology to see the difference in vibration when the medium is sensed on the forks. The use of alternating voltage current causes the piezo to expand and contract. The difference in vibration oscillation detected by the medium indicates the presence of the medium.



Photoelectric
Sensors



6-2...6-47

Proximity
Sensors



6-48...6-77

Ultrasonic
Sensors



6-78...6-81

Limit
Switches



6-82...6-93

Encoders



6-94...6-101

Condition
Sensing



6-102...6-111

Identification
Devices



6-112...6-115



Product Selection

840E Solid-State Level Switches

Connector Type	Process Connection	Power Supply	Cat. No.
DC-PNP with M12 connector	1/2 in. NPT (male)	DC-PNP	840E-TB1B1A1-D4
	3/4 in. NPT (male)	DC-PNP	840E-TB1B2A1-D4
AC with NPT 1/2 valve connector	1/2 in. NPT (male)	AC	840E-TB2B1A1-E4
	3/4 in. NPT (male)	AC	840E-TB2B2A1-E4



Connected Components

Simpler, faster, cost-effective machine building.

<https://rok.auto/ccw>

Specifications

Certifications	cCSAus Certified and CE Marked for all applicable directives
Enclosure Type Rating	DC-PNP with M12 connector: NEMA 4X (IP66/67) AC with NPT 1/2 valve connector: NEMA 4 (IP65)
Operating Temperature [C (F)]	-40...+70 ° (-40...+158 °)
Process Temperature [C (F)]	-40...+100 ° (-40...+212 °)
Operating Voltage	DC-PNP with M12 connector: 10...35V DC, 15 mA max. AC with NPT 1/2 valve connector: 19...253V AC, 3.8 mA max.
Load Current, Min.	250 mA
Repeatability	±0.5 mm (±0.02 in.)
Settling Time	< 2 s
Resolution [mm (in.)]	< 0.5 (0.02)
Hysteresis [mm (in.)]	3.0 ± 0.5 (0.12 ± 0.02)
Housing Material	316L stainless steel

Required Cordsets and Accessories

Description	Cat. No.
DC Micro QD cordset, straight, 4-pin, 2 m (6.5 ft)	889D-F4AC-2
AC DIN valve cordset	889V-RZ3ABE-2
Configuration Kit (includes converter cable and ReadWin 2000 software)	836E-NSR



Identification Devices

SENSORS

Code Reader 48CR

- Compact IP65/67 housing
- Two models available:
 - Standard: (WVGA, 0.3 MP resolution, fixed focus)
 - Advanced: (SXGA, 1.2 MP resolution, autofocus)
- Read ranges 102...400 mm (4.02...15.75 in.) fixed and adjustable
- Speeds up to 60 frames per second (fps) for fixed focus and 42 fps for autofocus code readers
- 16 LED-integrated illumination



EtherNet/IP®

The Smallest Industrial Code Reader on the Market

Provides clear, high-speed codes on any surface

The rugged 48CR decodes 1D/2D and Direct Part Marked (DPM) codes and solves the most challenging readings under any condition. Featuring the latest decoding algorithms technology, the 48CR can successfully read damaged and incomplete symbols despite scenarios with poor prints, scratches or various obstructions. The 48CR supports Ethernet/IP™ and can be configured through either the Studio 5000 Logix Designer® Add-On Profile (AOP) or the embedded WebConnect visual browser.

The 48CR solves difficult barcode reading challenges throughout various applications and industries:

- automotive • packaging • material handling • assembly • pharmaceutical • food and beverage

Able to read any barcode or QR code

- 1D/2D and Direct Part Marked (DPM) codes
- Advanced decoding algorithm allows for successful reads of damaged and/or incomplete symbols



Aztec



Data Matrix



Micro QR



QR

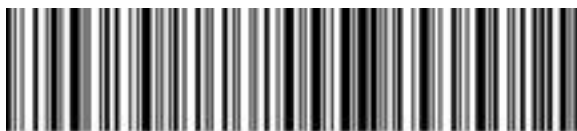

Code 128



PDF417

Note: Above example codes are scannable by the 48CR and can be used for demonstration. Additionally they all will 'decode' to spell Rockwell, RockwellAutomation or RockwellAutomation.com.

Photoelectric
Sensors



6-2...6-47

Proximity
Sensors



6-48...6-77

Ultrasonic
Sensors



6-78...6-81

Limit
Switches



6-82...6-93

Encoders

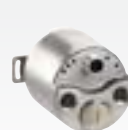

6-94...6-101

Condition
Sensing



6-102...6-111

Identification
Devices



6-112...6-115



Product Selection

48CR Code Reader

Focus	Resolution	Imager	Focal Distance	Cat. No.
Advanced	(Auto focus)	SXGA 1.2MP Resolution	5 mm 133 mm	48CR-CC50RAF-E8
Advanced	(Auto focus)	SXGA 1.2MP Resolution	7.7 mm 190 mm	48CR-CC77RAF-E8
Advanced	(Auto focus)	SXGA 1.2MP Resolution	16 mm 400 mm	48CR-CC16RAF-E8
Standard	(Fixed focus)	WVGA 0.3 MP Resolution	5.2 mm 102 mm	48CR-CB52R102-E8
Standard	(Fixed focus)	WVGA 0.3 MP Resolution	8 mm 133 mm	48CR-CB80R133-E8
Standard	(Fixed focus)	WVGA 0.3 MP Resolution	8 mm 190 mm	48CR-CB80R190-E8
Standard	(Fixed focus)	WVGA 0.3 MP Resolution	16 mm 400 mm	48CR-CB16R400-E8

Specifications

	Standard	Advanced
Certifications	FFC, CE, RoHC	
Enclosure Type Rating	Aluminum IP65/67	
Speed	High speed (up to 60 fps)	High speed (up to 42 fps)
Sensor (CMOS)	WYGA (0.34 MP, 752 x 480)	SXGA (1.2 MP, 1280 x 980)
Frames per second	WYGA (60 FPS)	SXGA (42 FPS)
Connectivity	M12 8-pin power, M12 4-pin Ethernet	
Digital I/O	2 opto-isolator inputs, 2 opto-isolator outputs	
Operating Temperature [C (F)]	0...+40 ° (-32...104 °)	
Dimensions	25 x 45 x 45 mm (1 x 1.75 x 1.75 in.)	

Accessories

Description	Cat. No.
Diffuser - lens cover kit	48CR-DIFFUSER
Polarizer - lens cover kit	48CR-POLARIZER
Bracket, L-shaped	48CR-LBKT
Adjustable bracket	48CR-ADJBKT
Right-angle mirror	48CR-45MIRROR
T-port	879D-F8D4M



Identification Devices

SENSORS

High Frequency RFID 56RF/59RF

- One- and two-channel EtherNet/IP and IO-Link interfaces available
- Production efficiency – detailed tracking of who, when, where and what was done to build product(s)
- Rugged IP67 (M18 and M30) and IP68 and IP69K (4040) enclosures for harsh industrial applications
- Pre-programmed batches – tags identify which recipe to load automatically, reducing errors



Track and Trace Materials Through Your Process

Industrial Radio Frequency Identification (RFID) systems are a rugged and reliable way to track and document products as they move through the manufacturing process. Unlike the bar code systems used for similar, less demanding applications, industrial RFID systems are designed to withstand harsh environments. Plus, reusable read/write tags allow for flexibility in information and application.

- Production efficiency – detailed tracking of who, when, where and what was done to build product(s)
- Rugged IP67 (M18 and M30) and IP68 and IP69K (4040) enclosures for harsh industrial applications
- Pre-programmed batches – tags identify which recipe to load automatically, reducing errors

Manufacturing Application

Each tool, person, and machine has an RFID tag for validation and usage count.



- Inventory control by tagging each tool
- Validate user checking out tool



- Validate tool with machine
- Read/write tool usage count



- Schedule tool maintenance during downtime
- Total tool usage count stored on tool RFID tag

Photoelectric Sensors



6-2...6-47

Proximity Sensors



6-48...6-77

Ultrasonic Sensors



6-78...6-81

Limit Switches



6-82...6-93

Encoders



6-94...6-101

Condition Sensing



6-102...6-111



Identification Devices



6-112...6-115

Product Selection

High Frequency 13.56 MHz ICODE with EtherNet/IP Interface Transceivers



Dimensions [mm (in.)]	Recommended Sensing Distance [mm (in.)]	Max. Sensing Distance [mm (in.)]	Cat. No.
Rectangular 80 x 90 (3.15 x 3.54)	100 (3.94)	168 (6.61)	56RF-TR-8090
Square 40 x 40 (1.57 x 1.57)	50 (1.97)	85 (3.35)	56RF-TR-4040
Cylindrical M30	35 (1.38)	60 (2.36)	56RF-TR-M30
Cylindrical M18	18 (7.09)	30 (1.18)	56RF-TR-M18
Cylindrical M18	10 (0.39)	34 (1.34)	59RF-TR-M18 
Cylindrical M30	23 (.91)	50 (1.97)	59RF-TR-M30 
Square 40 x 40 (1.57 x 1.57)	41 (1.61)	78 (3.07)	59RF-TR-4040 

Tags

Description	Type	Memory Size	Dimensions [mm (in.)]	Cat. No.
Disc	SLI	128 Bytes	16...50 (0.63...1.97)	56RF-TG- 
Disc - Mount on Metal	SLI	128 Bytes	50 (1.97)	56RF-TG-50MOM
Disc - FRAM	FRAM	2K Bytes	20...50 (0.79...1.97)	56RF-TG- \emptyset -2KB
Square - Hi Temp (220 °C (428 °F) max.)	SLI	128 Bytes	50 x 50 (1.97 x 1.97)	56RF-TG-50HT

* Other tags available

EtherNet/IP Interface Blocks

RFID Ports	Inputs	Outputs	Cat. No.
2	1	1	56RF-IN-IPD22
2	2	-	56RF-IN-IPD22A
1	1	1	56RF-IN-IPS12
IO LINK	Inputs	Outputs	Cat. No.
Armour Block	8	8	1732E-8IOLM12R 
POINT IO	four channels that can be individually configured		1734-4IOL 

 IO-Link enabled.

 Replace with diameter in millimeters (16, 30 or 50).

\emptyset Replace with diameter in millimeters (20, 30 or 50).

Specifications

Certifications	Interfaces & rectangular transceivers: cULus Listed, C-Tick, CE Marked for all applicable directives Cylindrical transceivers: CE Marked for all applicable directives
Operating Temperature [C (F)]	Interfaces: -20...+60 ° (-4...+140 °) Transceivers, Disc Tags < 20mm: -25...+70 ° (-13...+158 °) Disc Tags \geq 20mm: -25...+85 ° (-13...+185 °) Hi Temp Tags: -40...+220 ° (-40...+428 °)
Operating Voltage	24V DC
Output Current, max.	100 mA per transceiver
Frequency	13.56 MHz
Read/write Speed	625 B/s max.
Tag Memory	Up to 8 KB, SLI, SLIX & FRAM

* See individual product specifications

Required Cordsets and Accessories

Description	Cat. No.
DC Micro (M12) female straight to male straight QD patchcord, 5-pin, 2 m (6.5 ft)	889D-F5FCDM-J2
DC Micro (M12) female straight to male straight QD patchcord, 4-pin, 2 m (6.5 ft)	889D-F4ACDM-2
M12 D-code patchcords	1585D-M4TBDM-2
M12 D-code patchcords, male straight to male straight 4-pin shielded 2 m (6.5 ft)	1585D-M4UBDM-2

* Other cord-sets lengths/connections available



Additional Sensor Products



42KL MiniSight General Purpose

Bulletin 42KL Minisight™ general purpose sensors are an exact match for one of the industry's most popular form factors, but with additional features. 871D cylinder position models for in-port end-of-stroke detection on hydraulic and pneumatic cylinders.

- Universal 18 mm and through-hole mounting
- Durable 1200 psi washdown-rated housing
- 360° visible status indicators

45CLR ColorSight

The 45CLR ColorSight™ is a compact color sensing solution that offers high-end performance and advanced features to address a broad range of color-based inspection challenges.

- Concurrent sensing of three different colors
- Easy-to-use teach button (3 channels) and remote teach (single channel)
- IP67 housing with 270° rotatable connector



45BPD/BRD Laser Measurement

The Allen-Bradley 45BPD and 45BRD are laser sensors intended for industrial applications requiring reliable small part detection, positioning and precision measurement.

- Visible red Class 2 laser for small beam spot and easy alignment
- Teach-in and fixed range models
- IP67 housing with 270° rotatable connector

Photoelectric Sensors



6-2...6-47

Proximity Sensors



6-48...6-77

Ultrasonic Sensors



6-78...6-81

Limit Switches



6-82...6-93

Encoders



6-94...6-101

Condition Sensing



6-102...6-111

Identification Devices



6-112...6-115

Cylinder Position Sensors

Our cylinder position inductive proximity sensors are specialty models used to indicate position of pneumatic and hydraulic cylinders or power clamps and grippers.

- 871D cylinder position models for in-port end-of-stroke detection on hydraulic and pneumatic cylinders
- 871D WorldClamp™ sensors for open/closed position indication in power clamp and gripper applications
- Rugged, low-profile housings
- Weld-field immune



Rectangular Inductive Proximity Sensors

Our rectangular inductive proximity sensors offer sensing ranges longer than those found in traditional cylindrical housings. Choose from our many styles of rectangular sensors for your welding applications and other environments.

- 802PR heavy duty limit switch style sensors (including hazardous location models)
- 871L/872L limit switch style sensors
- 871F aluminum block sensors
- 871P can sensors



871C Specialty Proximity Sensors

We offer a complete line of 871C specialty inductive proximity sensors to address your toughest industrial applications in the harshest environments. Models include:

- Extended temperature
- Analog output
- Intrinsically safe
- Miniature



Additional Sensor Products



801 General Purpose Limit Switches

801 general purpose limit switches are ideal for a wide variety of applications.

- Multiple contact arrangements
- Slow and snap action contacts
- High snap-through force

802T Direct Action Limit Switches

802T direct action NEMA-style limit switches are used for safety applications per ISO 14119. Direct opening action assures that the normally closed contacts open when the limit switch is actuated.

- Direct opening action
- Snap acting contacts
- Rugged metal construction
- NEMA 6P/IP67 plug-in design



802R/X/XR Hazardous Location Limit Switches

Our hazardous location switches are designed for use in applications such as refineries, distilleries, grain elevators, and flour mills where dangerous gases or other materials may be present.

- 802R sealed contact (Class 1, Division 2)
- 802X NEMA Type 4 watertight (Class 1, groups B, C and D or Class 2, groups E, F and G or Class 3)
- 802XR sealed contact (Class 1, Groups B, C and D or Class 2, Groups E, F and G)

Photoelectric Sensors



6-2...6-47

Proximity Sensors



6-48...6-77

Ultrasonic Sensors



6-78...6-81

Limit Switches



6-82...6-93

Encoders



6-94...6-101

Condition Sensing



6-102...6-111

Identification Devices



6-112...6-115

Essential Components

Get the right components, at the right price, right when you need them.

Power



CIRCUIT BREAKERS



ROTARY
DISCONNECT SWITCHES



VISIBLE
BLADE
DISCONNECT SWITCHES



CONTROL & LOAD SWITCHES



IEC CONTACTORS



NEMA CONTACTORS

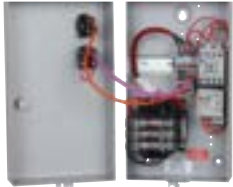

IEC STARTERS



NEMA STARTERS



MOTOR PROTECTION



SOLID-STATE MOTOR CONTROL



DRIVES

Logic



RELAYS & TIMERS



PROGRAMMABLE CONTROLLERS



CONTROL CIRCUIT & LOAD PROTECTION



POWER SUPPLIES



POWER QUALITY & ENERGY MANAGEMENT



SURGE & FILTER

Operator Interface



PUSH BUTTONS



SIGNALING



GRAPHIC TERMINALS

Connectivity



TERMINAL BLOCKS



WIRING SYSTEMS



SIGNAL INTERFACE



CONNECTION SYSTEMS



SAFETY CONNECTION SYSTEMS



NETWORK MEDIA

Safety



PRESENCE SENSING SAFETY DEVICES



INTERLOCK SWITCHES



ACCESS CONTROL



SAFETY RELAYS



EMERGENCY STOP DEVICES



SAFETY LIMIT SWITCHES

Sensors



PHOTOELECTRIC SENSORS



PROXIMITY SENSORS



ULTRASONIC SENSORS



LIMIT SWITCHES



ENCODERS



CONDITION SENSING



IDENTIFICATION DEVICES

Index

Bulletin Number	Page
22F.....	1-72
25A.....	1-74
25B.....	1-76
42AF.....	6-12
42BC.....	6-28
42BT.....	6-28
42CA.....	6-20
42CM.....	6-22, 6-24
42CS.....	6-26
42EF.....	6-14, 6-16
42G.....	6-18
42JA.....	6-10
42JS.....	6-6
42JT.....	6-6, 6-8
42KD.....	6-4
43GR.....	6-46
43GT.....	6-46
43PR.....	6-47
43PT.....	6-47
45AST.....	6-38
45CRM.....	6-32
45DLA.....	6-36
45FPL.....	6-42
45LMS.....	6-30
45LSP.....	6-42
45LUM.....	6-34
45MLA.....	6-36
45PLA.....	6-40
45PVA.....	6-38
46CLR.....	6-32
48CR.....	6-110
46DFA.....	6-44
59RF.....	6-114
100-C.....	1-30
100-E.....	1-34
100-K.....	1-28
100S-C.....	1-35
100S-E.....	1-35
104-C.....	1-30
104-E.....	1-34
104-K.....	1-28
104S-C.....	1-35
105-C.....	1-46
109-C.....	1-46
112.....	1-48
113.....	1-48
140G.....	1-3
140MG.....	1-3
140MP.....	1-3
140MT.....	1-3
150 SMC™ 3.....	1-66
150 SMC™ -50.....	1-70
150 SMC™ Flex.....	1-68
154.....	1-64
156-C.....	1-62
188-J.....	2-28
190E.....	1-44
191E.....	1-44
193 E100.....	1-58
193 E200/E300.....	1-60
193-K.....	1-56
193-T1.....	1-56
194E.....	1-26
194L.....	1-24
194R.....	1-16
194U.....	1-18
300.....	1-50
309.....	1-52

Bulletin Number	Page
312.....	1-54
313.....	1-54
400.....	1-40
440C.....	5-42
440E.....	5-48
440F.....	5-18
440G.....	5-34
440G-EZ.....	5-28
440G-LZ.....	5-30
440G-MZ.....	5-32
440K.....	5-24
440L.....	5-8, 5-12
440N.....	5-20, 5-22
440P.....	5-50, 6-91
440R.....	5-44
440T.....	5-38
442G.....	5-40
442L.....	5-14, 5-16
445L.....	5-10, 5-12
450L-B.....	5-4
440L-E.....	5-6
509.....	1-52
512.....	1-54
513.....	1-54
600.....	1-42
609.....	1-42
609TU.....	1-42
609U.....	1-42
700-CF.....	2-16
700-EF.....	2-16
700-FE.....	2-2
700-FS.....	2-2
700-HA.....	2-4
700-HC.....	2-6
700-HK.....	2-8
700-HL.....	2-10
700-HPS.....	2-18
700-HR.....	2-12
700-K.....	2-16
700-P.....	2-14
700S-CF.....	2-18
700S-EF.....	2-18
700S-P.....	2-18
700S-PK.....	2-18
800B.....	3-22
800F.....	3-2, 3-8
800FD.....	3-8, 3-10
800K.....	3-20
800T/H.....	3-12, 3-18
802B.....	6-93
802K.....	6-88
802M.....	6-86, 6-90
802MC.....	6-86
802T.....	6-82, 6-90
836P.....	6-104
837RTD.....	6-106
837T.....	6-106
839E.....	6-108
840E.....	6-110
842E.....	6-94
842HR.....	6-96
843ES.....	6-98
847H.....	6-100
847T.....	6-100
854J.....	3-26
854K.....	3-26
855B.....	3-34
855H.....	3-32

Bulletin Number	Page
855HM.....	3-32
855P.....	3-24
855W.....	3-30
856T.....	3-28
871A.....	4-47
871C.....	6-50
871F.....	6-74
871FM.....	6-68
871P.....	6-70, 6-72
871TM.....	6-58
871TS.....	6-62
871Z.....	6-66
871ZT.....	6-64
872C.....	6-52
873M.....	6-80
873P.....	6-78
875F.....	6-76
875L.....	6-76
888D.....	4-48
888N.....	4-49
888P.....	4-49
888R.....	4-48
889D.....	4-42
889N.....	4-44
889P.....	4-45
889R.....	4-43
898D.....	4-46
898P.....	4-46
898R.....	4-52
931N.....	4-36
931S.....	4-32
937C.....	4-38
937T.....	4-38
937Z.....	4-38
1408.....	2-44
1420.....	2-44
1426.....	2-44
1444.....	6-102
1489.....	2-26
1492.....	4-26, 4-30
1492-FB.....	2-32
1492-J.....	4-3
1492-L.....	4-3
1492-P.....	4-3
1492-PDE.....	4-32
1492-RCDA.....	2-30
1492-SPM.....	2-24
1494C.....	1-22
1494U.....	1-20
1494V.....	1-22
1585.....	4-56
1585A.....	4-59
1585D.....	4-57
1585J.....	4-58
1606.....	2-41
1606-XLB.....	2-36
1606-XLD.....	2-36
1606-XLE.....	2-36
1606-XLP.....	2-36
1606-XLS.....	2-36
1609-B.....	2-42
1609-D.....	2-42
1694.....	2-34
2080.....	2-20
2711R.....	3-36
4983-DS.....	2-46
4983-DC.....	2-48
4983-PF.....	2-48

Join Us

Take advantage of upcoming events to learn more about how you can use technology as a competitive advantage – to get your products and services to market faster, reduce costs, better utilize power and plant-floor assets, and minimize the risks in your manufacturing environment.



Automation Fair®



**Process Solutions
User Group**



On the Move



Rockwell Automation offers a variety of global industry events for partners and customers to learn more about our products and technologies.
<https://rok.auto/events>

Rockwell Automation offers a breadth of quality Allen-Bradley® components to fit your specific needs. In order to assist you with your component selection, we offer a variety of configuration and selection tools.

Local Distributor

Visit <https://rok.auto/distributor> to find your local Distributor.



Online Product Directory





Our extensive product portfolio is designed to improve your processes through every stage of your manufacturing cycle. <https://rok.auto/directory>



Product Selection Toolbox

Our powerful range of product selection and system configuration tools assist you in choosing and applying our products. <https://rok.auto/selection>



Connect with us.    

rockwellautomation.com ————— **expanding human possibility®**

AMERICAS: Rockwell Automation, 1201 South Second Street, Milwaukee, WI 53204-2496 USA, Tel: (1) 414.382.2000, Fax: (1) 414.382.4444

EUROPE/MIDDLE EAST/AFRICA: Rockwell Automation NV, Pegasus Park, De Kleetlaan 12a, 1831 Diegem, Belgium, Tel: (32) 2 663 0600, Fax: (32) 2 663 0640

ASIA PACIFIC: Rockwell Automation, Level 14, Core F, Cyberport 3, 100 Cyberport Road, Hong Kong, Tel: (852) 2887 4788, Fax: (852) 2508 1846

Allen-Bradley, AppView, ArcShield, ArmorBlock, ArmorBlock Guard I/O, ArmorPower, ArmorStart, ArmorStratix, Atlas Guard Locking Switch, Cadet, CENTERLINE, ClearMultiPrint, ClearPlot, ClearSight, ClearTools, ColorSight, CompactBlock Guard I/O, CompactLogix, Connected Components Workbench, Control Tower, ControlLogix, CustomView, DeviceLogix, Dysc, E1 Plus Electronic Overload Relay, E300 Electronic Overload Relay, Elf Miniature Tongue Interlock Switch, expanding human possibility, FactoryTalk EnergyMetrix, Ferrogard, Flex I/O, Guard I/O, GuardLogix, Guardmaster, GuardPLC, GuardShield, i-Grid, i-Sense, Kinetix, KwikLink, LaserSight, Lifeline, MachineAlert, MCS, Micro800, Micro810, Micro820, Micro830, Micro850, Micro870, MicroLogix, Minisight, On-Machine, PanelView, POINT I/O, PowerFlex, PowerMonitor, ProSafe, QuadConnect, RightSight, Rockwell Automation, Rotacam, RSEnergyMetrix, Safedge, SafeZone, SensaGuard, Series 9000, SmartGuard, SMC, Stratix, Studio 5000, Studio 5000 Logix Designer, ToughCoat Finish, ToughLink, ToughWeld, Trojan Tongue Interlock Switch, VersaCube, VisiSight and WorldProx are trademarks of Rockwell Automation. Trademarks not belonging to Rockwell Automation are property of their respective companies.

Publication EC-CA100E-EN-P – August 2021 | Supersedes Publication EC-CA100D-EN-P – August 2018

Copyright © 2021 Rockwell Automation, Inc. All Rights Reserved. Printed in USA.

