



# CompactLogix and Compact GuardLogix Systems

CompactLogix 5380, Compact GuardLogix 5380

CompactLogix 5480

CompactLogix 5370, Compact GuardLogix 5370

Armor CompactLogix 5370, Armor Compact GuardLogix 5370



**Allen-Bradley**

by ROCKWELL AUTOMATION

Selection Guide

Original Instructions

## What's Inside

Topic	Page
What's New	2
CompactLogix Controllers Overview	6
CompactLogix 5380 Controllers	9
Compact GuardLogix 5380 Controllers	10
CompactLogix 5480 Controllers	11
CompactLogix 5370 Controllers	12
CompactLogix 5370 L1 Controllers with Embedded I/O	12
CompactLogix 5370 L2 Controllers with Embedded I/O	13
CompactLogix 5370 L3 Controllers	14
Compact GuardLogix 5370 Controllers	15
Armor CompactLogix and Armor Compact GuardLogix Controllers	16
CompactLogix Communication Options	17
EtherNet/IP Communication Options	17
EtherNet/IP Modes	19
DeviceNet Communication Options	20
Serial Communication Options	21
Modbus Support	21
Integrated Motion	22
Integrated Safety	23
Compact GuardLogix 5380 Integrated Safety	23
Compact GuardLogix 5370 Integrated Safety	24
Local I/O Modules	26
Compact 5000 I/O Modules	26
1734 POINT I/O Modules	30
1769 Compact I/O Modules	33
CompactLogix Power Supplies	39
Additional Resources	41

## What's New

This publication contains the following new or updated information. This list includes substantive updates only and is not intended to reflect all changes. Translated versions are not always available for each revision.

Topic	Page
Updated Artwork	Throughout
Added Modules 5069-L310ERMK, 5069-L310ERS2K, 5069-L310ERMS2K, 5069-L310ERMS3K	Throughout

## CompactLogix Controllers Comparison

Characteristic	CompactLogix™ 5380 Compact GuardLogix 5380	CompactLogix 5480	CompactLogix 5370 L3 Compact GuardLogix 5370 L3 Armor™ CompactLogix 5370 L3 Armor Compact GuardLogix 5370	CompactLogix 5370 L2	CompactLogix 5370 L1
Controller tasks: • Continuous • Periodic • Event	32 1000 programs/task				
Event tasks	Consumed tag, EVENT instruction triggers, Module Input Data Change, and motion events	Consumed tag, EVENT instruction triggers, Module Input Data Change, and motion events	Consumed tag, EVENT instruction triggers, and motion events		
User memory	Standard 0.6...10MB Safety 0.3...5 MB	Standard 3...20MB	Standard 1.0...5.0 MB Safety 0.5...1.5 MB	750 KB...1.0 MB	384 KB ...1.0 MB
Built-in ports	2 - Ethernet, 10 Mbps/100 Mbps/1 Gbps 1 - port USB client	Logix control engine use: • 3 - Ethernet, 10 Mbps/100 Mbps/1 Gbps • 1- USB client Microsoft Windows® 10 use: • 1 - Ethernet, 10 Mbps/100 Mbps/1 Gbps • 2 - USB 3.0 ports • 1 - DisplayPort	2 - Ethernet, 10 Mbps/100 Mbps 1 - USB Client	2 - Ethernet, 10 Mbps/100 Mbps 1 - USB Client	2 - Ethernet, 10 Mbps/100 Mbps 1 - USB Client
Communication options	<ul style="list-style-type: none"> <li>EtherNet/IP™ <ul style="list-style-type: none"> <li>Embedded switch</li> <li>Two IP address</li> </ul> </li> <li>USB Client</li> </ul>	<ul style="list-style-type: none"> <li>EtherNet/IP <ul style="list-style-type: none"> <li>Embedded switch</li> <li>Two IP address</li> </ul> </li> <li>USB Client</li> </ul>	<ul style="list-style-type: none"> <li>EtherNet/IP <ul style="list-style-type: none"> <li>Embedded switch</li> <li>Single IP address</li> </ul> </li> <li>DeviceNet®</li> <li>USB Client</li> </ul>	<ul style="list-style-type: none"> <li>EtherNet/IP <ul style="list-style-type: none"> <li>Embedded switch</li> <li>Single IP address</li> </ul> </li> <li>DeviceNet</li> <li>USB Client</li> </ul>	<ul style="list-style-type: none"> <li>EtherNet/IP <ul style="list-style-type: none"> <li>Embedded switch</li> <li>Single IP address</li> </ul> </li> <li>USB Client</li> </ul>
Controller connections	—	—	256 connections		
Network nodes <sup>(1)</sup>	16...180	60...250	16...80	8...16	4...8
Controller redundancy	None	None	Back up via DeviceNet	None	None
Conformal coating	Available	None	Available	Available	Available

(1) Use the most current version of the Logix Designer application. Previous versions can support fewer nodes.

**Notes:**

# Select a CompactLogix System

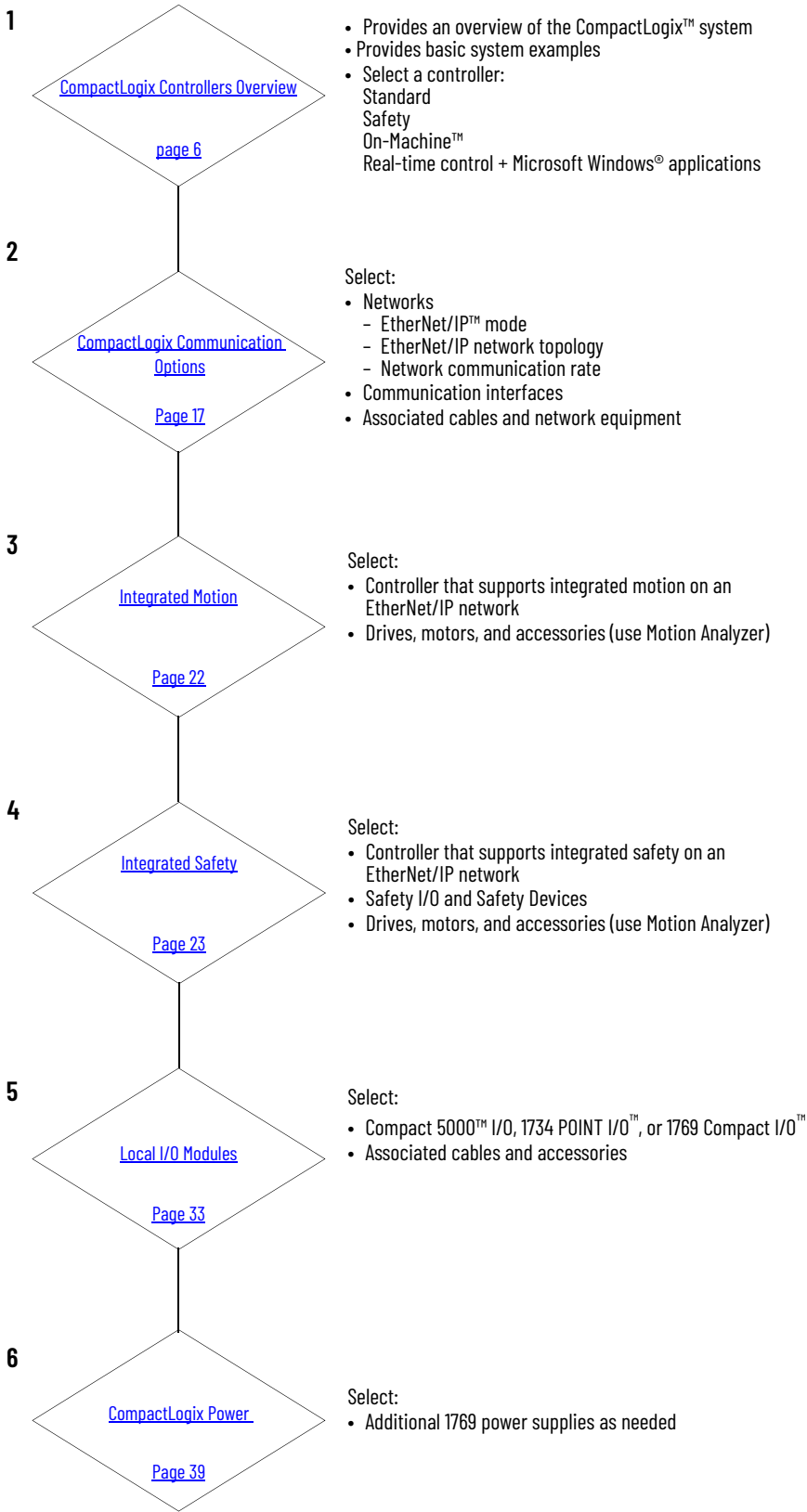

# CompactLogix Controllers Overview

The CompactLogix system is designed to provide a Logix solution for differently sized applications. Most CompactLogix controllers are ideal for small and mid-size applications. These applications are machine-level control applications. The CompactLogix 5480 controllers, however, are more ideal for use in mid to large-size applications.

The CompactLogix platform brings together the benefits of a common programming environment, common networks, and common control engine in a small footprint with high performance. Combined with 1769 Compact I/O or Compact 5000 I/O modules, the CompactLogix platform supports simple to more complex motion, with unprecedented power and scalability. A CompactLogix platform is ideal for systems that require standalone and system-connected control over EtherNet/IP, ControlNet®, or DeviceNet® networks.

For detailed specifications, see the following publications:

- CompactLogix 5380, Compact GuardLogix 5380, and CompactLogix 5480 Controllers Specifications Technical Data, publication [5069-TD002](#)
- CompactLogix Controllers Specifications Technical Data, publication [1769-TD005](#)

## Standard CompactLogix Example: Dual-IP Mode with a Device Level Ring

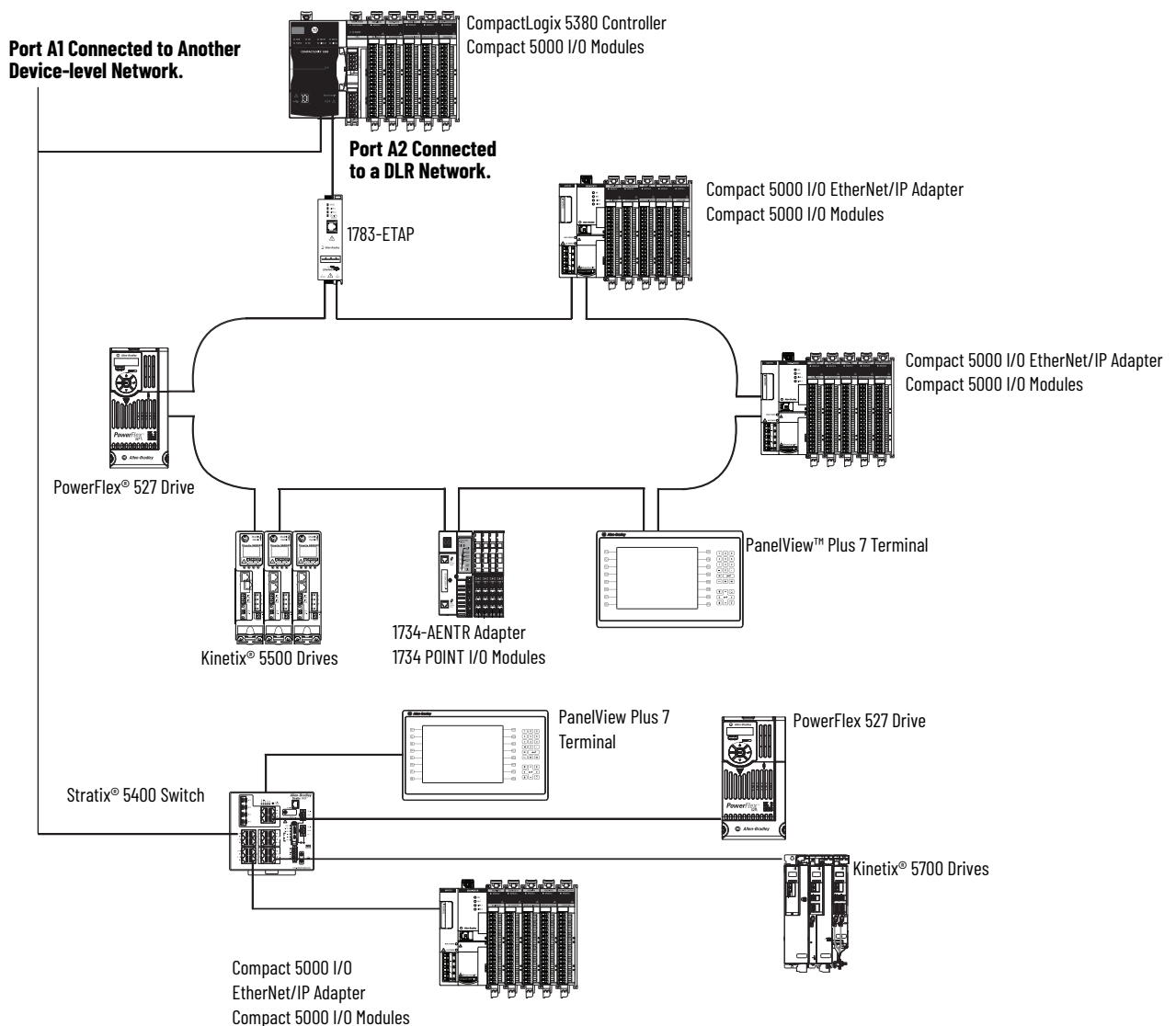

**Compact GuardLogix® Example: Motion and Safety Configuration (single controller)**

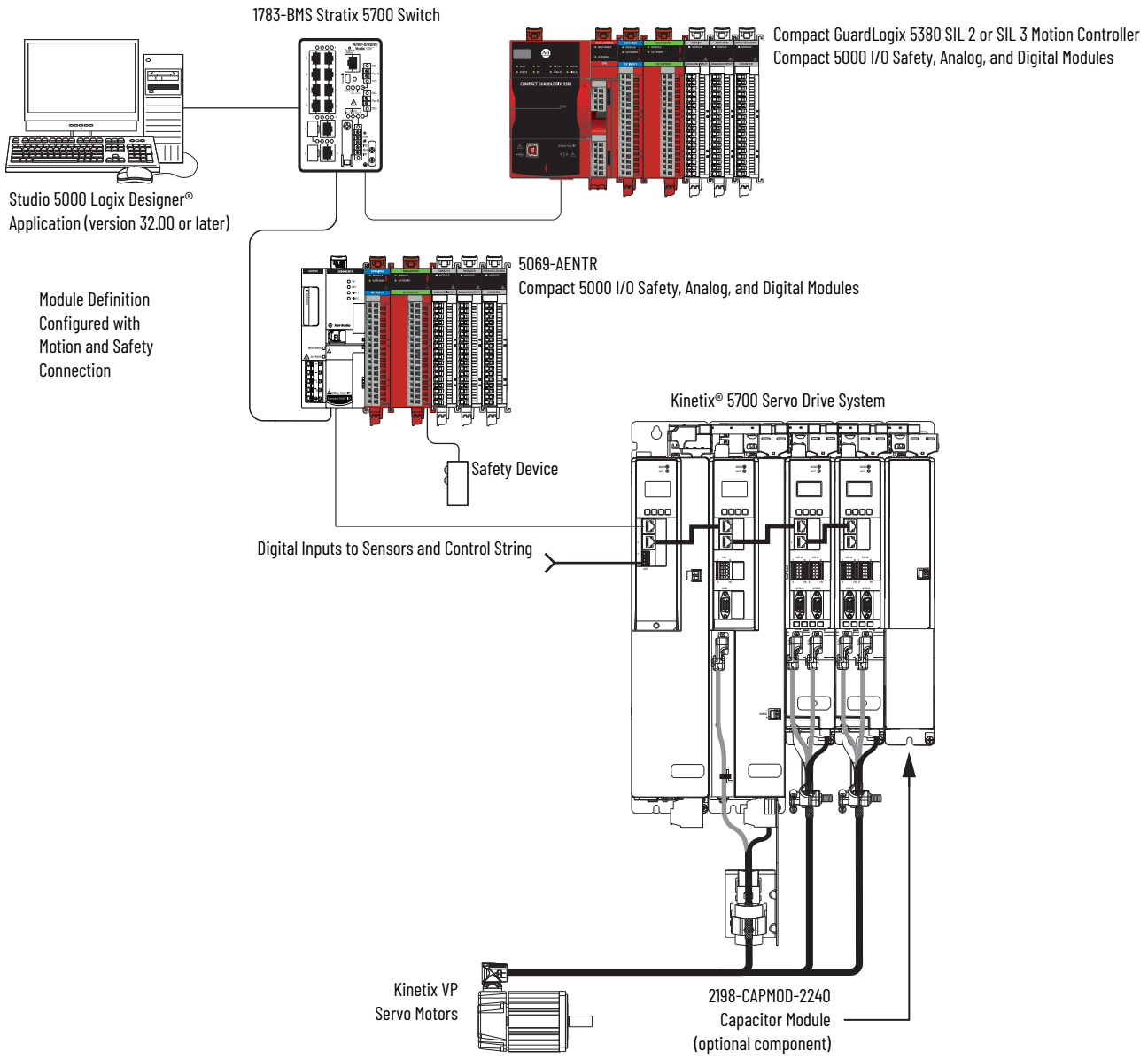

# CompactLogix 5480 Example: Connected to Enterprise-level and Device-level Networks

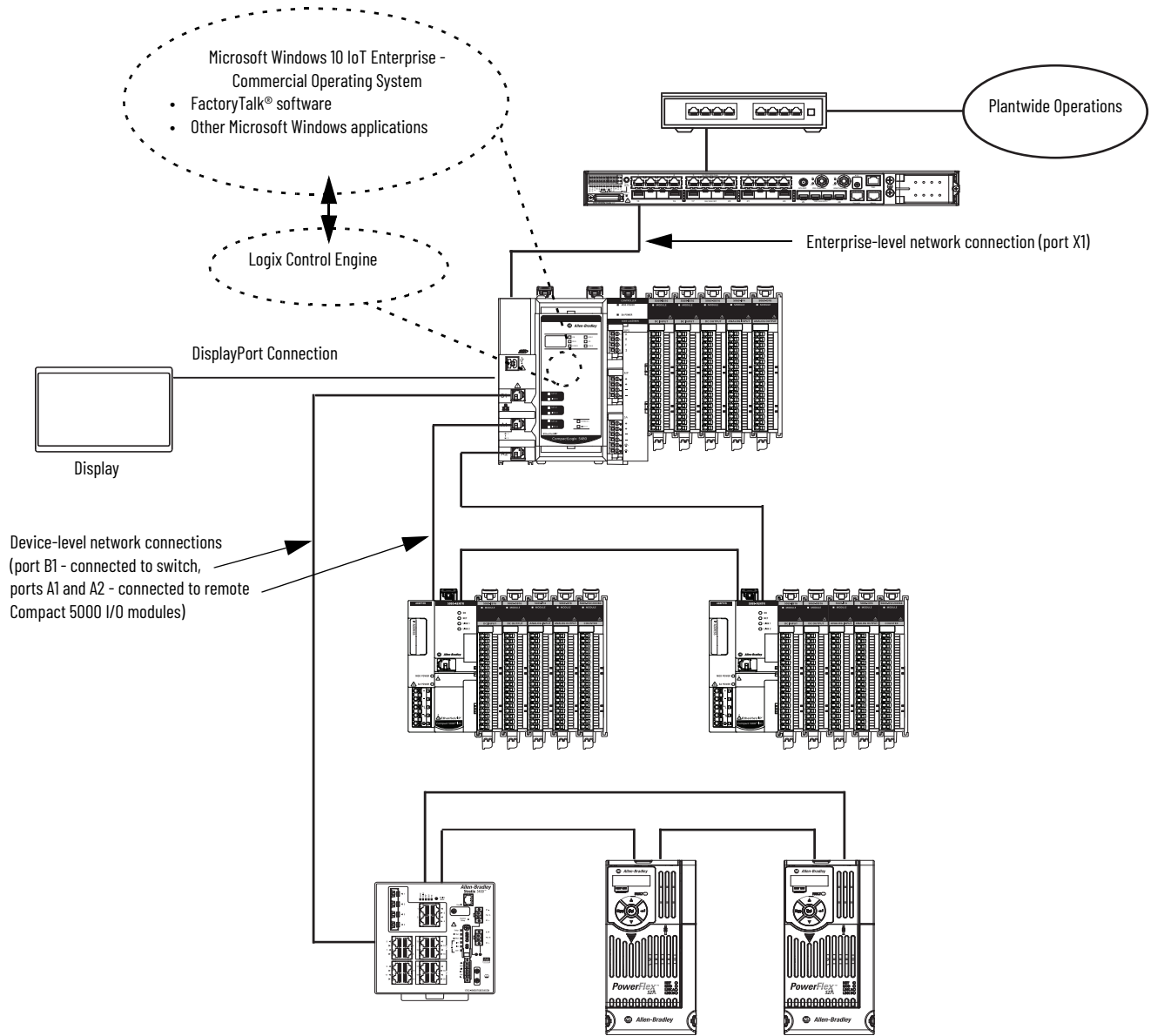



# CompactLogix 5380 Controllers

CompactLogix™ 5380 controllers help enable faster system performance, capacity, productivity and security to meet the growing demands of smart machines and equipment for manufacturing.

All CompactLogix™ 5380 controllers use the Studio 5000® development environment, combining elements of design into one standard framework that can optimize productivity and reduce time to commission.

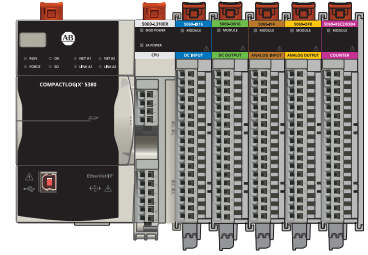

The CompactLogix 5380 controllers offer configurable EtherNet/IP modes, that is, Dual-IP mode or Linear/DLR mode. When the controller operates in Dual-IP mode, each port requires its own network configuration.

The residual stored energy of the 5069-L310ER-NSE controller depletes to 400 µJ or less in 40 seconds. The 5069-L310ER-NSE controller does not maintain the real-time clock on power cycle.

CompactLogix 5380 process controllers (5069-L320ERP, 5069-L340ERP) are extensions of the Logix 5000™ controller family that focus on plantwide process control. The process controller comes configured with a default process tasking model and dedicated PlantPax® process instructions optimized for process applications and that improve design and deployment efforts. CompactLogix 5380 process controllers support motion, and are conformal coated for extended protection in harsh, corrosive environments.

Characteristic	5069-L306ER, 5069-L306ERM	5069-L310ER, 5069-L310ER-NSE, 5069-L310ERM, 5069-L310ERMK	5069-L320ER, 5069-L320ERM, 5069-L320ERMK, 5069-L320ERP	5069-L330ER, 5069-L330ERM, 5069-L330ERMK	5069-L340ER, 5069-L340ERM, 5069-L340ERP	5069-L350ERM, 5069-L350ERMK	5069-L380ERM	5069-L3100ERM
Available user memory	0.6 MB	1 MB	2 MB	3 MB	4 MB	5 MB	8 MB	10 MB
Memory card	1784-SD1 (1 GB), 1784-SD2 (2 GB) - ships with controller, 1784-SDHC8 (8 GB), 1784-SDHC32 (32 GB), 9509-CMSDCD4 (4 GB) CodeMeter CmCard card							
Communication ports	2 - Ethernet, 10 Mbps/100 Mbps/1 Gbps 1- USB client							
EtherNet/IP nodes supported, max <sup>(1)</sup>	16	24	40	60	90	120	150	180
Axes supported, max <sup>(2)(3)</sup>	256							
CIP® Drive axes (position loop) supported, max	5069-L306ERM: 2	5069-L310ERM: 4	5069-L320ERM, 5069-L320ERMK: 8	5069-L330ERM, 5069-L330ERMK: 16	5069-L340ERM: 20	24	28	32
Local I/O modules, max	8		16	31 <sup>(4)</sup>				
Battery	None							
Power supply terminals (kits sold separately)	5069-RTB64-SCREW kit: Includes 5069-RTB6-SCREW and 5069-RTB4-SCREW RTBs 5069-RTB64-SPRING kit: Includes 5069-RTB6-SPRING and 5069-RTB4-SPRING RTBs							
Programming software support	Based on catalog number: <ul style="list-style-type: none"> <li>• Version 28 or later - 5069-L320ER, 5069-L340ERM only</li> <li>• Version 29 or later - 5069-L306ER, 5069-L306ERM, 5069-L310ER, 5069-L310ER-NSE, 5069-L310ERM, 5069-L310ERMK, 5069-L320ERM, 5069-L320ERMK, 5069-L330ER, 5069-L330ERM, 5069-L330ERMK, 5069-L340ER</li> <li>• Version 30 or later - 5069-L350ERM, 5069-L350ERMK, 5069-L380ERM, 5069-L3100ERM</li> <li>• Version 33 or later - 5069-L320ERP, 5069-L340ERP</li> </ul>							

(1) Use the most current version of the Logix Designer application. Previous versions can support fewer nodes.

(2) Only controllers that have an M and P in their catalog number support Integrated Motion on EtherNet/IP networks.

(3) Any combination of CIP Drive, Virtual, Consumed, Regenerative AC/DC Converter and Non-Regenerative AC/DC Converter axis types.

(4) When you use a 5069-L330ER, 5069-L330ERM, or 5069-L330ERMK controller with the Logix Designer application, version 29.00.00, the application limits the number of local I/O modules in the project to 16. For more information, see the Knowledgebase article [5380 CompactLogix controllers limited to 16 local 5069 modules in V29 of Studio 5000](#) software. With the Logix Designer application, version 30.00.00 or later, the controller supports as many as 31 local I/O modules.

# Compact GuardLogix 5380 Controllers

Compact GuardLogix 5380 controllers function in the same way as CompactLogix 5380 controllers and provide the functionality to perform safety functions.

- The Compact GuardLogix SIL 2 Controllers can achieve up to SIL 2/PLd (Category 3) with the use of the safety task and safety I/O.
- The Compact GuardLogix SIL 3 Controllers have an internal safety partner, and can achieve up to SIL 3/PLe (Category 4) with the use of the safety task and safety I/O.



During development, safety and standard have the same rules; multiple programmers, online editing, and forcing are all allowed. Once the safety system is validated and the safety signature applied, safety memory is protected, the safety logic cannot be modified.

**IMPORTANT** You must use SELV/PELV-rated power supplies for Module (MOD) power and Sensor Actuator (SA) power. You can only use DC SA power with Compact GuardLogix 5380 controllers.

Characteristic (5069-)	L306ERS2, L306ERMS2, L306ERMS3	L310ERS2, L310ERS2K, L310ERMS2, L310ERMS2K, L310ERMS3, L310ERMS3K	L320ERS2, L320ERMS2, L320ERS2K, L320ERMS2K, L320ERMS3, L320ERMS3K	L330ERS2, L330ERMS2, L330ERS2K, L330ERMS2K, L330ERMS3, L330ERMS3K	L340ERS2, L340ERMS2, L340ERMS3	L350ERS2, L350ERMS2, L350ERS2K, L350ERMS2K, L350ERMS3, L350ERMS3K	L380ERS2, L380ERMS2, L380ERMS3	L3100ERS2, L3100ERMS2, L3100ERMS3
Available user memory	0.6 MB + 0.3 MB safety	1 MB + 0.5 MB safety	2 MB + 1 MB safety	3 MB + 1.5 MB safety	4 MB + 2 MB safety	5 MB + 2.5 MB safety	8 MB + 4 MB safety	10 MB + 5 MB safety
Memory card	1784-SD1 (1 GB) 1784-SD2 (2 GB), ships with controller 1784-SDHC8 (8 GB) 1784-SDHC32 (32 GB) 9509-CMSDCD4 (4 GB) CodeMeter CmCard card							
Communication ports	2 - Ethernet, 10 Mbps/100 Mbps/1 Gbps 1 - USB client							
EtherNet/IP nodes supported, max	16	24	40	60	90	120	150	180
Axes supported, max <sup>(1)(2)</sup>	256							
CIP Drive axes (position loop) supported, max (5069-)	L306ERMS2, L306ERMS3: 2	L310ERMS2, L310ERMS2K, L310ERMS3, L310ERMS3K: 4	L320ERMS2, L320ERMS2K, L320ERMS3, L320ERMS3K: 8	L330ERMS2, L330ERMS2K, L330ERMS3, L330ERMS3K: 16	L340ERMS2, L340ERMS3: 20	L350ERMS2, L350ERMS2K, L350ERMS3, L350ERMS3K: 24	L380ERMS2, L380ERMS3: 28	L3100ERMS2, L3100ERMS3: 32
Local I/O modules, max	8		16	31				
Battery	None							
Power supply terminals (kits sold separately)	5069-RTB64-SCREW kit: Includes 5069-RTB6-SCREW and 5069-RTB4-SCREW RTBs 5069-RTB64-SPRING kit: Includes 5069-RTB6-SPRING and 5069-RTB4-SPRING RTBs							
Programming software support	Compact GuardLogix SIL 2 Controllers: Version 31 or later Compact GuardLogix SIL 3 Controllers: Version 32 or later							

(1) Only controllers that have an M in their catalog number support Integrated Motion on EtherNet/IP networks.

(2) Any combination of CIP Drive, Virtual, Consumed, Regenerative AC/DC Converter and Non-Regenerative AC/DC Converter axis types.

# CompactLogix 5480 Controllers

The CompactLogix 5480 Controller offers the benefits of Logix control with Microsoft Windows computing. With a commercially available CPU and a Microsoft Windows 10 IoT Enterprise operating system running independently of the Logix control engine, it provides a high-performance architecture with the ability to run 3rd-party applications.



The CompactLogix 5480 controllers deliver scalable control that is ideal for mid-size to large applications that require high-performance control and data throughput. The CompactLogix 5480 controllers also provide an integrated motion solution.

Characteristic	5069-L430ERMW	5069-L450ERMW	5069-L4100ERMW	5069-L4200ERMW
Memory: Logix control engine	3 MB	5 MB	10 MB	20 MB
Memory: Microsoft Windows 10 (COS on controller)	RAM - 6 GB SSD - 64 GB			
Memory card	1784-SD1 (1 GB) 1784-SD2 (2 GB), ships with controller 1784-SDHC8 (8 GB) 1784-SDHC32 (32 GB) 9509-CMSDCD4 (4 GB) CodeMeter CmCard card			
Communication ports	Logix control engine use: • 3 - Ethernet, 10 Mbps/100 Mbps/1 Gbps • 1- USB client Microsoft Windows 10 use: • 1 - Ethernet, 10 Mbps/100 Mbps/1 Gbps			
EtherNet/IP nodes supported, max	60	120	180	250
Axes supported, max <sup>(1)</sup>	512			
CIP Drive axes (position loop) supported, max	16	24	32	150
Local I/O modules, max	31			
Battery	None			
Power supply terminals (ship with controller)	5069-RTB4-SCREW RTB 5069-RTB6-SCREW RTB 5069-L4UPSRTB RTB			
Programming software support	Version 32.01.00 or later			

(1) Any combination of CIP Drive, Virtual, Consumed, Regenerative AC/DC Converter and Non-Regenerative AC/DC Converter axis types.

# CompactLogix 5370 Controllers

The CompactLogix 5370 controllers include integrated safety and use the same programming software, network protocol, and information capabilities as all Logix controllers. These controllers are ideal for small, to mid-size applications that require low axis motion and I/O point counts.

- The CompactLogix 5370 L3 controllers deliver scalable, affordable control ideal for applications from small standalone equipment to high-performance indexing tables, process skids, case packers and erectors, and packaging.
- The CompactLogix 5370 L2 controllers combine the power of the Logix architecture with the flexibility of 1769 Compact I/O modules. From small standalone equipment to higher performance applications, these controllers are ideal for assembly machines, hoisting systems, process skids, indexing tables, and packaging.
- The CompactLogix 5370 L1 controllers combine the power of the Logix architecture with the flexibility of 1734 POINT I/O modules. Ideal for small to mid-size machines, these controllers offer value to customers who need the benefits of an Integrated Architecture® system in a lower-cost system.

## CompactLogix 5370 L1 Controllers with Embedded I/O

The CompactLogix 5370 L1 controller comes with:

- A built-in, 24V DC isolated power supply module.<sup>(1)</sup>
- Dual Ethernet ports for linear and ring topologies.
- USB port for firmware updates and programming.
- Embedded digital I/O (16 DC inputs, 16 DC outputs).
- Support for 1734 POINT I/O.



Characteristic	1769-L16ER-BB1B	1769-L18ER-BB1B	1769-L18ERM-BB1B 1769-L18ERM-BB1BK	1769-L19ER-BB1B 1769-L19ER-BB1BK
Available user memory	384 KB	512 KB	512 KB	1 MB
Memory card	1784-SD1 (1 GB), shipped with controller 1784-SD2 (2 GB)			
Communication ports	2 EtherNet/IP 1 USB			
Embedded I/O	16 sinking 24V DC digital input points 16 sourcing 24V DC digital output points			
EtherNet/IP connections	256 EtherNet/IP 120 TCP			
EtherNet/IP nodes supported, max	4	8		
Axes supported, max <sup>(1)</sup>	Not Applicable	Not Applicable	100	Not Applicable
CIP Drive axes (position loop) supported, max	Not Applicable	Not Applicable	2	Not Applicable
Module expansion capacity	6 POINT I/O modules	8 POINT I/O modules		
Battery	None			
Embedded power supply	10...28.8V DC 24V DC nominal			
Programming software support	Version 20 - For controllers that use firmware revision 20. Version 21 or later - For controllers that use firmware revision 21 or later.			Version 28 or later - For controllers that use firmware revision 28 or later.

(1) Any combination of CIP Drive, Virtual, Consumed, Regenerative AC/DC Converter and Non-Regenerative AC/DC Converter axis types.

(1) Only series B power supply modules are isolated. Series A power supply modules are non-isolated. For more information on how to connect a 24V DC power source to the 24V DC nonisolated power supply of the CompactLogix 5370 L1 controller, see the CompactLogix 5370 Controllers User Manual, publication [1769-UM021](#).

## CompactLogix 5370 L2 Controllers with Embedded I/O

The CompactLogix 5370 L2 controller comes with:

- A built-in, 24V DC power supply module.
- Dual Ethernet ports for linear and ring topologies.
- USB port for firmware updates and programming.
- A combination of embedded digital, analog, and high-speed counter I/O.
- A 1769-ECR right-end cap.
- Support for 1769 Compact I/O.



Characteristic	1769-L24ER-QB1B	1769-L24ER-QBFC1B, 1769-L24ER-QBFC1BK	1769-L27ERM-QBFC1B
Available user memory	0.75 MB	0.75 MB	1 MB
Memory card	1784-SD1 (1 GB), shipped with controller 1784-SD2 (2 GB)		
Communication ports	2 EtherNet/IP 1 USB		
Embedded I/O	16 sinking/sourcing 24V DC digital input points 16 sourcing 24V DC digital output points	16 sinking/sourcing 24V DC digital input points 16 sourcing 24V DC digital output points 4 universal analog input points 2 analog output points 4 high-speed counters	
EtherNet/IP connections	256 EtherNet/IP 120 TCP	256 EtherNet/IP 120 TCP	256 EtherNet/IP 120 TCP
EtherNet/IP nodes supported, max	8		16
Axes supported, max <sup>(1)</sup>	Not Applicable	Not Applicable	100
CIP Drive axes (position loop) supported, max	Not Applicable	Not Applicable	4
Module expansion capacity	4 1769 modules		
Battery	None		
Embedded power supply	24V DC		
Programming software support	Version 20 - For controllers that use firmware revision 20. Version 21 or later - For controllers that use firmware revision 21 or later.		

(1) Any combination of CIP Drive, Virtual, Consumed, Regenerative AC/DC Converter and Non-Regenerative AC/DC Converter axis types.

These controllers replace previous catalog numbers.

New Controller	Replaces Previous Controller	Differences
1769-L24ER-QBFC1B	1769-L23-QBFC1B 1769-L23E-QBFC1B	Additional memory Integrated motion on EtherNet/IP support (1769-L27ERM-QBFC1B) USB port instead of RS-232 port Dual-port EtherNet/IP support SD card support addition Support for additional expansion I/O modules
1769-L24ER-QB1B	1769-L23E-QB1B	
1769-L27ERM-QBFC1B	1769-L23E-QBFC1B	

# CompactLogix 5370 L3 Controllers



The CompactLogix 5370 L3 controller comes with:

- Dual Ethernet ports for linear and ring topologies.
- USB port for firmware updates and programming.
- Support for 1769 Compact I/O.

Use the 1769-L30ER-NSE controller for mining applications. You can deplete the residual stored energy of the 1769-L30ER-NSE controller to 200 µJ or less before you transport it into or out of a mine. The 1769-L30ER-NSE controller does not maintain the real-time clock on power cycle.

Characteristic	1769-L30ER 1769-L30ERK	1769-L30ERM 1769-L30ERMK	1769-L30ER-NSE	1769-L33ER 1769-L33ERK	1769-L33ERM 1769-L33ERMK	1769-L36ERM	1769-L37ERM 1769-L37ERMK	1769-L38ERM 1769-L38ERMK
Available user memory	1 MB	1 MB	1 MB No capacitor	2 MB	2 MB	3 MB	4 MB	5 MB
Memory card	1784-SD1 (1 GB), shipped with controller 1784-SD2 (2 GB)							
Communication ports	2 EtherNet/IP 1 USB							
EtherNet/IP connections	256 EtherNet/IP 120 TCP							
EtherNet/IP nodes supported, max	16			32		48	64	80
Axes supported, max <sup>(1)</sup>	Not Applicable	100	Not Applicable	Not Applicable	100	100		
CIP Drive axes (position loop) supported, max	Not Applicable	4	Not Applicable	Not Applicable	8	16		
Module expansion capacity	8 1769 modules 1 bank of modules			16 1769 modules 2 banks of modules		30 1769 modules 3 banks of modules		
Battery	None							
Power supply distance rating	4 modules			4 modules		4 modules		
Programming software support	Version 20 - For controllers that use firmware revision 20. Version 21 or later - For controllers that use firmware revision 21 or later.						Version 31 or later	

(1) Any combination of CIP Drive, Virtual, Consumed, Regenerative AC/DC Converter and Non-Regenerative AC/DC Converter axis types.

These controllers replace previous catalog numbers.

New Controller <sup>(1)</sup> (2)	Replaces Previous Controller	Differences
1769-L30ER 1769-L30ERM 1769-L30ER-NSE	1769-L31 1769-L32C <sup>(3)</sup> 1769-L32E	Additional memory Integrated motion on EtherNet/IP support (1769-L30ERM, 1769-L33ERM, 1769-L36ERM) USB port instead of RS-232 port Dual-port EtherNet/IP support SD card instead of CompactFlash card
1769-L33ER 1769-L33ERM	1769-L35CR <sup>(3)</sup> 1769-L35E 1768-L43	
1769-L36ERM	1768-L45 Any previous 1769-L3x and 1769-L4x controller.	

(1) Typically, you can use any of the new controllers that are listed in each row as replacements for any of the previous controllers that are listed in the corresponding cell to the right. For example, you can replace a 1769-L32E controller with a 1769-L30ER, 1769-L30ERM, or 1769-L30ER-NSE controller. In some rare cases, system configuration helps to prevent controller replacement as shown in the previous table. For example, if your system uses a 1769-L32E controller with 12 expansion modules, you cannot replace that controller with a 1769-L30ER, 1769-L30ERM, or 1769-L30ER-NSE controller. Those controllers support no more than eight expansion modules. You must replace the 1769-L32E controller with a 1769-L33ER, 1769-L33ERM, or 1769-L36ERM controller. We recommend that before you upgrade your controllers, consider your application requirements to verify that the replacements that are listed previously apply.

(2) If you require Serial communication, consider a CompactLogix 5380 solution with the 5069-SERIAL module.

(3) Requires converting from ControlNet connections to EtherNet/IP connections.

# Compact GuardLogix 5370 Controllers

The Compact GuardLogix 5370 controller provides safety control at SIL CL3 according to EN62061 / EN 61511-1 / IEC 61508 and PLe according to EN ISO 13849-1.



Characteristic	1769-L30ERMS	1769-L33ERMS 1769-L33ERMASK	1769-L36ERMS	1769-L37ERMS 1769-L37ERMASK	1769-L38ERMS 1769-L38ERMASK
Available user memory	1 MB + 0.5 MB (safety)	2 MB + 1 MB (safety)	3 MB + 1.5 MB (safety)	4 MB + 1.5 MB (safety)	5 MB + 1.5 MB (safety)
Memory card	1784-SD1 (1 GB), shipped with controller 1784-SD2 (2 GB)				
Communication ports	2 EtherNet/IP 1 USB				
EtherNet/IP connections	256 EtherNet/IP 120 TCP				
EtherNet/IP nodes supported, max	16	32	48	64	80
Axes supported, max <sup>(1)</sup>	100				
CIP Drive axes (position loop) supported, max	4	8	16		
Module expansion capacity	Eight 1769 modules One bank of modules	Sixteen 1769 modules Two banks of modules	Thirty 1769 modules Three banks of modules		
Battery	None				
Power supply distance rating	Four modules				
Programming software support	Version 28 or later - For controllers that use firmware revision 28 or later.			Version 31 or later	

(1) Any combination of CIP Drive, Virtual, Consumed, Regenerative AC/DC Converter and Non-Regenerative AC/DC Converter axis types.

# Armor CompactLogix and Armor Compact GuardLogix Controllers



The Armor™ CompactLogix™ and Armor™ Compact GuardLogix® controllers deliver standard, safety and motion control for On-Machine applications. You can obtain SIL 3, PL(e), CAT 4 safety control in the Armor Compact GuardLogix controller and standard control in the Armor CompactLogix controller.

On-Machine controllers offer global certifications and ratings and Ingress Protection (IP67) for dust and wash-down protection for immersion between 15 cm...1 m (5.91...393.70 in.) in harsher environments.

Characteristic	1769-L33ERMO	1769-L36ERMO	1769-L37ERMO	1769-L38ERMO	1769-L33ERMOS	1769-L36ERMOS	1769-L37ERMOS	1769-L38ERMOS
Available user memory	2 MB	3 MB	4 MB	5 MB	2 MB + 1 MB (safety)	3 MB + 1.5 MB (safety)	4 MB + 1.5 MB (safety)	5 MB + 1.5 MB (safety)
Memory card	1784-SD1 (1 GB), shipped with controller 1784-SD2 (2 GB)							
Communication ports	2 EtherNet/IP 1 USB							
EtherNet/IP connections	256 EtherNet/IP 120 TCP							
EtherNet/IP nodes supported, max	32	48	64	80	32	48	64	80
Axes supported, max <sup>(1)</sup>	100							
CIP Drive axes (position loop) supported, max	8	16			8	16		
Programming software support	Version 28 or later - For controllers that use firmware revision 28 or later. Version 31 or later - 1769-L37ERMO, 1769-L38ERMO, and 1769-L38ERMOS							

(1) Any combination of CIP Drive, Virtual, Consumed, Regenerative AC/DC Converter and Non-Regenerative AC/DC Converter axis types.



# CompactLogix Communication Options

You can configure your system for information exchange between a range of devices and computing platforms and operating systems. Select a CompactLogix controller with integrated communication or the appropriate communication module.

For detailed specifications, see:

- CompactLogix 5380, Compact GuardLogix 5380, and CompactLogix 5480 Controllers Specifications Technical Data, publication [5069-TD002](#)
- Compact 5000 I/O Modules and EtherNet/IP Adapters Specifications Technical Data, publication [5069-TD001](#)
- CompactLogix Controllers Specifications Technical Data, publication [1769-TD005](#).
- CompactLogix Communication Modules Specifications Technical Data, publication [1769-TD007](#).

## EtherNet/IP Communication Options

The Ethernet Industrial network protocol (EtherNet/IP) is an open industrial-networking standard that supports real-time I/O messaging and message exchange. The EtherNet/IP network uses off-the-shelf Ethernet communication chips and physical media.

Dual-port EtherNet/IP support embeds switch technology directly in the controller to so the controller can operate on star, linear, or ring EtherNet/IP topologies.

### CompactLogix Controller EtherNet/IP Communication Options

Cat. No.	Description	Communication Rate	Logix Resources <sup>(1), (2)</sup>	TCP/IP Connections
5069-L306ER, 5069-L306ERM	CompactLogix 5380 controller with embedded dual Ethernet ports	10/100 Mbps, 1 Gbps <sup>(3)</sup>	16	—
5069-L310ER, 5069-L310ER-NSE, 5069-L310ERM, 5069-L310ERMK			24	
5069-L320ER, 5069-L320ERM, 5069-L320ERMK			40	
5069-L330ER, 5069-L330ERM, 5069-L330ERMK			60	
5069-L340ER, 5069-L340ERM			90	
5069-L350ERM, 5069-L350ERMK			120	
5069-L380ERM			150	
5069-L3100ERM			180	
5069-L306ERS2, 5069-L306ERMS2, 5069-L306ERMS3			Compact GuardLogix 5380 controller with embedded dual Ethernet ports	
5069-L310ERS2, 5069-L310ERS2K, 5069-L310ERMS2, 5069-L310ERMS2K, 5069-L310ERMS3, 5069-L310ERMS3K	24			
5069-L320ERS2, 5069-L320ERMS2, 5069-L320ERS2K, 5069-L320ERMS2K, 5069-L320ERMS3, 5069-L320ERMS3K, 5069-L320ERP	40			
5069-L330ERS2, 5069-L330ERMS2, 5069-L330ERS2K, 5069-L330ERMS2K, 5069-L330ERMS3, 5069-L330ERMS3K	60			
5069-L340ERS2, 5069-L340ERMS2, 5069-L340ERMS3, 5069-L340ERP	90			
5069-L350ERS2, 5069-L350ERMS2, 5069-L350ERS2K, 5069-L350ERMS2K, 5069-L350ERMS3, 5069-L350ERMS3K	120			
5069-L380ERS2, 5069-L380ERMS2, 5069-L380ERMS3	150			
5069-L3100ERS2, 5069-L3100ERMS2, 5069-L3100ERMS3	180			
5069-L430ERMW	CompactLogix 5480 controller with embedded Ethernet ports	10/100 Mbps, 1 Gbps <sup>(5)</sup>		60
5069-L450ERMW			120	
5069-L4100ERMW			180	
5069-L4200ERMW			250	

## CompactLogix Controller EtherNet/IP Communication Options (continued)

Cat. No.	Description	Communication Rate	Logix Resources <sup>(1), (2)</sup>	TCP/IP Connections
1769-L16ER-BB1B	CompactLogix 5370 L1 controller with embedded dual Ethernet ports, POINT I/O form factor	10/100 Mbps	4 nodes 256 EtherNet/IP connections	120
1769-L18ER-BB1B 1769-L18ERM-BB1B, 1769-L18ERM-BB1BK			8 nodes 256 EtherNet/IP connections	
1769-L19ER-BB1B, 1769-L19ER-BB1BK				
1769-L24ER-QB1B 1769-L24ER-QBFC1B 1769-L24ER-QBFC1BK	CompactLogix 5370 L2 controller with embedded dual Ethernet ports, 1769 Compact I/O form factor	10/100 Mbps	8 nodes 256 EtherNet/IP connections	120
1769-L27ERM-QBFC1B		10/100 Mbps	16 nodes 256 EtherNet/IP connections	
1769-L30ER, 1769-L30ERK, 1769-L30ERM, 1769-L30ERMK, 1769-L30ERMOS	CompactLogix 5370 L3 controller with embedded dual Ethernet ports	10/100 Mbps	16 nodes 256 EtherNet/IP connections	120
1769-L33ER, 1769-L33ERK, 1769-L33ERM, 1769-L33ERMOS, 1769-L33ERMK, 1769-L33ERMOSK, 1769-L33ERMO, 1769-L33ERMOS			32 nodes 256 EtherNet/IP connections	
1769-L36ERM, 1769-L36ERMOS, 1769-L36ERMO, 1769-L36ERMOS			48 nodes 256 EtherNet/IP connections	
1769-L37ERM, 1769-L37ERMOS, 1769-L37ERMK, 1769-L37ERMOSK, 1769-L37ERMO, 1769-L37ERMOS			64 nodes 256 EtherNet/IP connections	
1769-L38ERM, 1769-L38ERMOS, 1769-L38ERMK, 1769-L38ERMOSK, 1769-L38ERMO, 1769-L38ERMOS			80 nodes 256 EtherNet/IP connections	

- (1) The number of nodes that are listed for CompactLogix 5370, CompactLogix 5380, Compact GuardLogix 5380, CompactLogix 5480 controllers represents the maximum number of EtherNet/IP nodes you can include in a Logix Designer application project. For example, in a controller project that uses a 1769-L18ERM-BB1B controller, you can add as many as eight EtherNet/IP nodes to the project.
- (2) The maximum number of nodes that are listed represents when the controller is used with the Logix Designer application, version 31 or later. Some controllers can be used with earlier Logix Designer application versions. The maximum number of nodes that a controller supports can be fewer in the Logix Designer application, versions 30 or earlier.
- (3) Network performance in a CompactLogix 5380 system is optimal if the 1 Gbps network communication rate is used. However, many Ethernet devices do not support the 1 Gbps network communication rate. You must consider how the different maximum network communication rates impact your CompactLogix 5380 control system when you design the system.
- (4) Network performance in a Compact GuardLogix 5380 system is optimal if the 1 Gbps network communication rate is used. However, many Ethernet devices do not support the 1 Gbps network communication rate. You must consider how the different maximum network communication rates impact your Compact GuardLogix 5380 control system when you design the system.
- (5) Network performance in a CompactLogix 5480 system is optimal if the 1 Gbps network communication rate is used. However, many Ethernet devices do not support the 1 Gbps network communication rate. You must consider how the different maximum network communication rates impact your CompactLogix 5480 control system when you design the system.

# EtherNet/IP Modes

These controllers offer multiple EtherNet/IP modes:

- CompactLogix 5380
- Compact GuardLogix 5380
- CompactLogix 5480 (Dual-IP mode enabled by default)

For more information on EtherNet/IP modes, see the following:

- CompactLogix 5380 and Compact GuardLogix 5380 Controllers User Manual, publication [5069-UM001](#)
- CompactLogix 5480 Controllers User Manual, publication [5069-UM002](#)

## Dual-IP Mode

Dual-IP mode lets you configure the embedded Ethernet ports to connect to separate EtherNet/IP networks, that is, an enterprise-level network and a device-level network. The machine internal network is isolated from factory network. In this mode, each port requires its own network configurations that include some restrictions. For example, when you set IP addresses in Dual-IP mode, you cannot overlap IP addresses between the ports.

### Dual-IP Mode with Enterprise-level and Device-level Network Connections

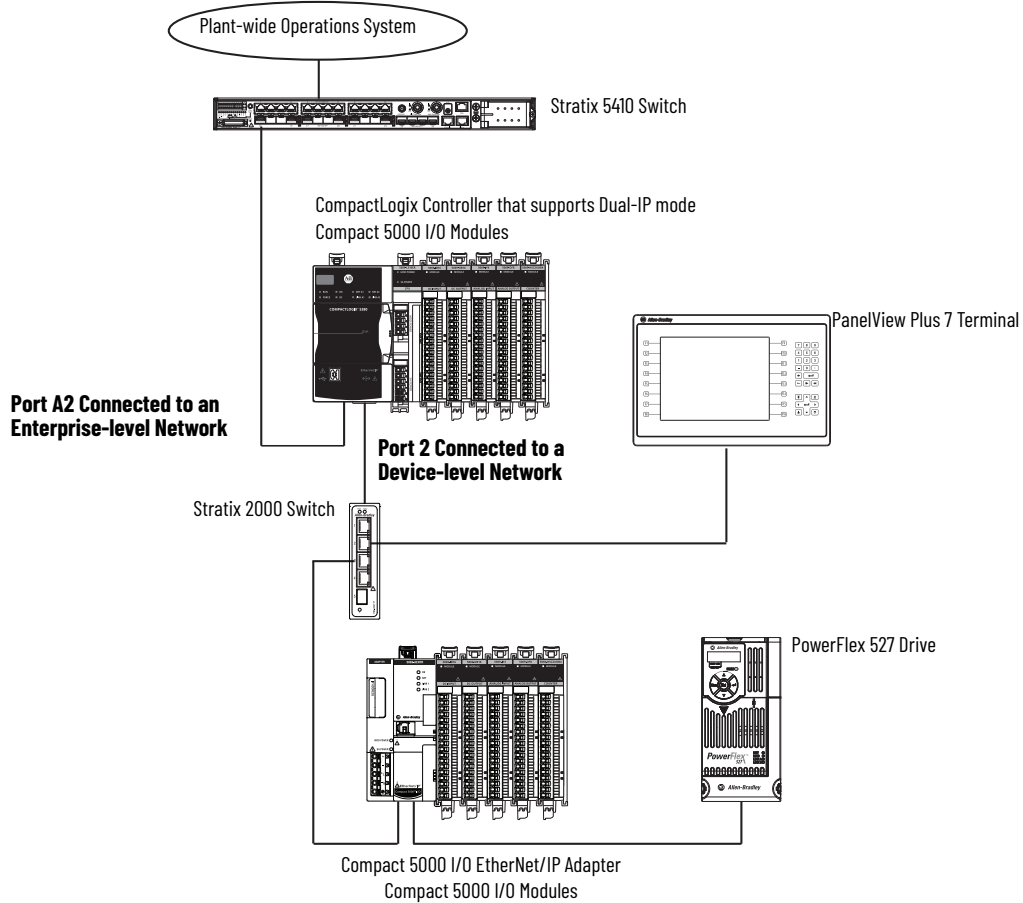

## Linear/DLR Mode

In Linear/DLR mode, the controller connects to only one network. Linear/DLR mode supports any EtherNet/IP network topology—linear, DLR, or star.

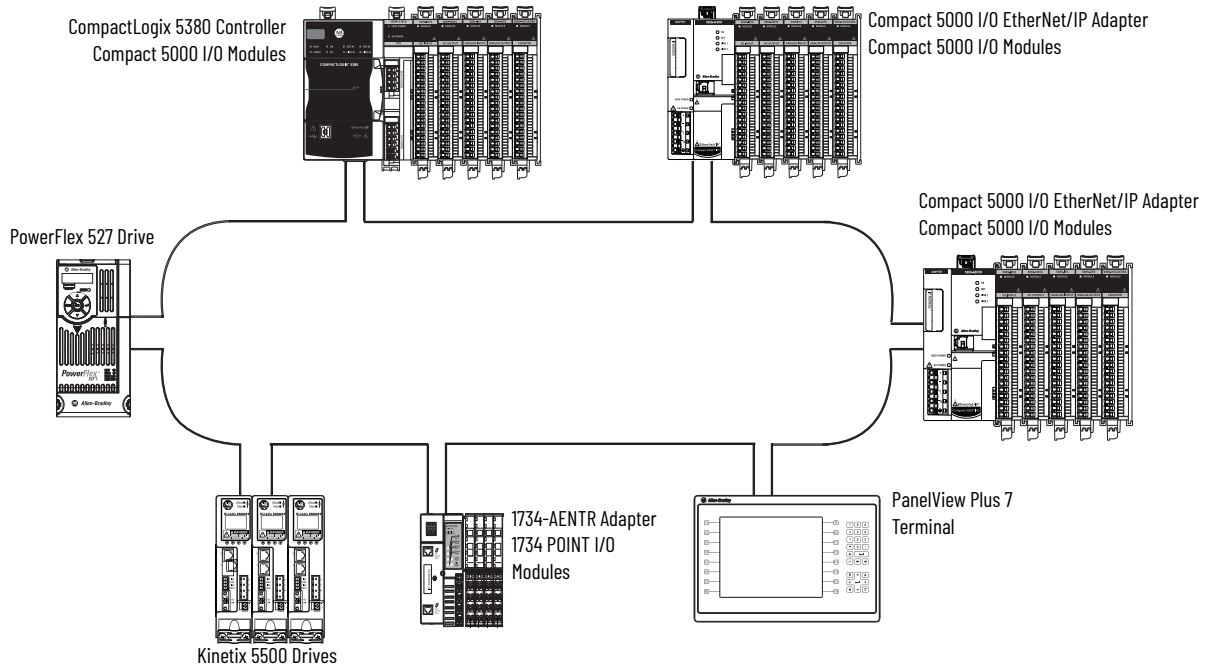

## DeviceNet Communication Options

The DeviceNet network is an open, low-level network that provides connections between simple industrial devices (such as sensors and actuators) and higher-level devices (such as controllers and computers).

Cat. No.	Description	Communication Rate	Number of Nodes
1769-SDN 1769-SDNK <sup>(1)</sup>	1769 Compact I/O DeviceNet scanner	125 Kbps (500 m, max) 250 Kbps (250 m, max) 500 Kbps (100 m, max)	64

(1) Module has conformal coating.

## Serial Communication Options

These CompactLogix controllers support serial communication.

Cat. No.	Serial Options
1769-L16ER-BB1B, 1769-L18ER-BB1B, 1769-L18ERM-BB1B, 1769-L18ERM-BB1BK, 1769-L19ER-BB1B, 1769-L19ER-BB1BK	1734-232ASC module for an RS-232 serial interface 1734-485 ASC module for an RS-422 and RS-485 serial device
1769-L24ER-QB1B, 1769-L24ER-QBFC1B, 1769-L24ER-QBFC1BK	1769-ASCII module for an ASCII interface to RS-232, RS-422, and RS-485 devices 1769-SM2 module for a Modbus RTU interface
1769-L27ERM-QBFC1B	
1769-L30ER, 1769-L30ERK, 1769-L30ERM, 1769-L30ERMK, 1769-L30ERMS	
1769-L33ER, 1769-L33ERK, 1769-L33ERM, 1769-L33ERMS, 1769-L33ERMO, 1769-L33ERMOS, 1769-L33ERMK, 1769-L33ERMSK	
1769-L36ERM, 1769-L36ERMS, 1769-L36ERMO, 1769-L36ERMOS	
1769-L37ERM, 1769-L37ERMS, 1769-L37ERMK, 1769-L37ERMSK, 1769-L37ERMO, 1769-L37ERMOS	
1769-L38ERM, 1769-L38ERMS, 1769-L38ERMK, 1769-L38ERMSK, 1769-L38ERMO, 1769-L38ERMOS	5069-SERIAL module for an ASCII, Modbus, DF1, and DH485 interface to RS-232, RS-422, and RS-485 devices
5069-L306ER, 5069-L306ERM, 5069-L306ERS2, 5069-L306ERMS2, 5069-L306ERMS3, 5069-L310ER, 5069-L310ER-NSE, 5069-L310ERM, 5069-L310ERMK, 5069-L310ERS2, 5069-L310ERS2K, 5069-L310ERMS2, 5069-L310ERMS2K, 5069-L310ERMS3, 5069-L310ERMS3K,	
5069-L320ER, 5069-L320ERM, 5069-L320ERMK, 5069-L320ERS2, 5069-L320ERMS2, 5069-L320ERS2K, 5069-L320ERMS2K, 5069-L320ERMS3, 5069-L320ERMS3K, 5069-L320ERP,	
5069-L330ER, 5069-L330ERM, 5069-L330ERMK, 5069-L330ERS2, 5069-L330ERMS2, 5069-L330ERS2K, 5069-L330ERMS2K, 5069-L330ERMS3, 5069-L330ERMS3K,	
5069-L340ER, 5069-L340ERM, 5069-L340ERS2, 5069-L340ERMS2, 5069-L340ERMS3, 5069-L340ERP,	
5069-L350ERM, 5069-L350ERMK, 5069-L350ERS2, 5069-L350ERMS2, 5069-L350ERS2K, 5069-L350ERMS2K, 5069-L350ERMS3, 5069-L350ERMS3K,	
5069-L380ERM, 5069-L380ERS2, 5069-L380ERMS2, 5069-L380ERMS3,	
5069-L3100ERM, 5069-L3100ERS2, 5069-L3100ERMS2, 5069-L3100ERMS3	
5069-L430ERMW, 5069-L450ERMW, 5069-L4100ERMW, 5069-L4200ERMW	

## Modbus Support

To access a Modbus TCP network, connect through the embedded Ethernet port of the CompactLogix 5370 or CompactLogix 5380 controllers and execute a ladder logic routine. For more information, see Knowledgebase document 470365 at <http://www.rockwellautomation.com/knowledgebase/>.

To access a Modbus RTU network via a CompactLogix 5370 or Compact GuardLogix 5370 L3 controller, connect through a 1769-SM2 module, or Encompass™ partner, ProSoft ModBus module, or Gateway and execute a ladder logic routine. For more information, see Using Logix 5000 Controllers as Masters or Slaves on Modbus Application Solution, publication [CIG-AP129](#).

To access a Modbus RTU network via a CompactLogix 5380, Compact GuardLogix 5380 controller, or CompactLogix 5480 controller, connect through a 5069-SERIAL module and execute a ladder logic routine. For more information, see the Compact 5000 I/O Serial Module User Manual, publication [5069-UM003](#).

# Integrated Motion

The standard and safety CompactLogix controllers support motion control components that work in a wide variety of machine architectures. Controllers with an M or P in their catalog numbers support motion.

- Integrated motion on an EtherNet/IP network
- EtherNet/IP sequence of events for software registration
- Kinematics
- Networked motion via the DeviceNet network to one axis drive to perform point-to-point indexing
- Load observer with Kinetix 6500 drives

Motion Feature	CompactLogix 5380	Compact GuardLogix 5380	CompactLogix 5480	CompactLogix 5370 L3	CompactLogix 5370 L2	CompactLogix 5370 L1
Axes supported, max <sup>(1)</sup>	256		512	100		
CIP Drive axes (Position loop-configured) supported, max <sup>(2)</sup>	5069-L306ERM: 2 5069-L310ERM, 5069-L310ERMK: 4 5069-L320ERM, 5069-L320ERMK, 5069-L320ERP: 8 5069-L330ERM, 5069-L330ERMK: 16 5069-L340ERM, 5069-L350ERM, 5069-L350ERMK: 24 5069-L380ERM: 28 5069-L3100ERM: 32	5069-L306ERMS2, 5069-L306ERMS3: 2 5069-L310ERMS2, 5069-L310ERMS2K, 5069-L310ERMS3, 5069-L310ERMS3K: 4 5069-L320ERMS2, 5069-L320ERMS2K, 5069-L320ERMS3, 5069-L320ERMS3K: 8 5069-L330ERMS2, 5069-L330ERMS2K, 5069-L330ERMS3, 5069-L330ERMS3K: 16 5069-L340ERMS2, 5069-L340ERMS3: 20 5069-L350ERMS2, 5069-L350ERMS2K, 5069-L350ERMS3, 5069-L350ERMS3K: 24 5069-L380ERMS2, 5069-L380ERMS3: 28 5069-L3100ERMS2, 5069-L3100ERMS3: 32	5069-L430ERMW: 16 5069-L450ERMW: 24 5069-L4100ERMW: 32 5069-L4200ERMW: 150	1769-L30ERM, 1769-L30ERMK, 1769-L30ERMS: 4 1769-L33ERM, 1769-L33ERMK, 1769-L33ERMO, 1769-L33ERMOS, 1769-L33ERMS, 1769-L33ERMSK: 8 1769-L36ERM, 1769-L36ERMO, 1769-L36ERMOS, 1769-L36ERMS: 16 1769-L37ERM, 1769-L37ERMS, 1769-L37ERMK, 1769-L37ERMOS, 1769-L37ERMO, 1769-L37ERMOS: 16 1769-L38ERM, 1769-L38ERMS, 1769-L38ERMO, 1769-L38ERMOS, 1769-L38ERMK, 1769-L38ERMSK: 16	1769-L27ERM-QBFC1B, 1769-L27ERM-QBFC1BK: 4	1769-L18ERM-BB1B: 2
Indexing	Yes			Yes with AMCI 1769-3602 pulse-train output module		Yes with one of these pulse-train output modules: • AMCI 1734-3401 • AMCI 1734-3401L
EtherNet/IP feedback, VHz, torque, or velocity axis, max	180		5069-L430ERMW: 60 5069-L450ERMW: 120 5069-4100ERMW: 180 5069-L4200ERMW: 250	80	16	8

(1) Any combination of CIP Drive, Virtual, Consumed, Regenerative AC/DC Converter and Non-Regenerative AC/DC Converter axis types.

(2) The maximum number of CIP Drive axes (configured for Position Loop) that can be included in the total integrated motion axes count for a controller.

For more information, see the:

- CompactLogix 5380 and Compact GuardLogix 5380 Controllers User Manual, publication [5069-UM001](#).
- CompactLogix 5480 Controllers User Manual, publication [5069-UM002](#).
- Motion Analyzer CD to size your motion application and to make final component selection. Download the software from <http://www.ab.com/motion/software/analyzer.html>.
- Kinetix Motion Control Selection Guide, publication [GMC-SG001](#), to verify drive, motor, and accessory specifications.

# Integrated Safety

## Compact GuardLogix 5380 Integrated Safety

The Compact GuardLogix 5380 controller provides safety control to achieve up to SIL 3/PLe according to ISO 13849. A major benefit of this system is that it is still one project, safety, and standard together.

Application	Description
SIL 1, 2, 3	<p>The Compact GuardLogix 5380 SIL 2 controller system is type-approved and certified for use in safety applications up to and including SIL 2 according to IEC 61508, and applications up to and including PLd/Cat.3 according to ISO 13849-1.</p> <p>The Compact GuardLogix 5380 SIL 3 controller system has an internal safety partner, and is type-approved and certified for use in safety applications up to and including SIL 3 according to IEC 61508, and applications up to and including PLe/Cat.4 according to ISO 13849-1.</p> <p>For more information, see:</p> <ul style="list-style-type: none"> <li>• CompactLogix 5380 and Compact GuardLogix Controllers User Manual, publication <a href="#">5069-UM001</a></li> <li>• GuardLogix 5580 and Compact GuardLogix 5380 Controller Safety Systems Safety Reference Manual, publication <a href="#">1756-RM012</a></li> <li>• GuardLogix Safety Application Instruction Set Reference Manual, publication <a href="#">1756-RM095</a></li> </ul>

The Compact GuardLogix 5380 controller has these safety-related features and the standard features of a CompactLogix 5380 controller.

Characteristic (5069-)	L306ERMS2, L306ERMS3	L310ERS2, L310ERS2K, L310ERS2K, L310ERS2K, L310ERS3, L310ERS3K	L320ERMS2, L320ERS2K, L320ERS2K, L320ERS3, L320ERS3K	L330ERMS2, L330ERS2K, L330ERS2K, L330ERS3, L330ERS3K	L340ERMS2, L340ERMS3	L350ERMS2, L350ERS2K, L350ERS2K, L350ERS3, L350ERS3K	L380ERMS2, L380ERMS3	L3100ERMS2, L3100ERMS3
Available user memory	0.6 MB standard 0.3 MB safety	1 MB standard 0.5 MB safety	2 MB standard 1 MB safety	3 MB standard 1.5 MB safety	4 MB standard 2 MB safety	5 MB standard 2.5 MB safety	8 MB standard 4 MB safety	10 MB standard 5 MB safety
Communication options	<ul style="list-style-type: none"> <li>• Dual-port EtherNet/IP</li> <li>• USB Client</li> </ul>							
Programming languages	<ul style="list-style-type: none"> <li>• Standard task: all languages</li> <li>• Safety task: relay ladder, safety application instructions</li> </ul>							

## Compact GuardLogix 5370 Integrated Safety

The Compact GuardLogix 5370 controller provides safety control to achieve SIL 3/PLe according to ISO 13849. A major benefit of this system is that it is still one project, safety, and standard together.

Application	Description
SIL 1, 2, 3	<p>The Compact GuardLogix controller system is type-approved and certified for use in safety applications up to and including SIL 3 according to IEC 61508, and applications up to and including PLe/Cat.4 according to ISO 13849-1. For more information, see:</p> <ul style="list-style-type: none"> <li>GuardLogix Controllers User Manual, publication <a href="#">1769-UM022</a>.</li> <li>GuardLogix 5370 and Compact GuardLogix 5370 Controller Safety Systems Safety Reference Manual, publication <a href="#">1756-RM099</a></li> <li>GuardLogix Safety Application Instruction Set Reference Manual, publication <a href="#">1756-RM095</a>.</li> </ul> <p>For more information on safety application requirements for 1768 Compact GuardLogix controllers, see:</p> <ul style="list-style-type: none"> <li>Compact GuardLogix Controllers User Manual, publication <a href="#">1768-UM002</a>.</li> <li>GuardLogix Controller Systems Safety Reference Manual, publication <a href="#">1756-RM093</a>.</li> </ul>

The Compact GuardLogix controller has these safety-related features and the standard features of a CompactLogix controller.

Characteristic	1769-L30ERMS	1769-L33ERMS 1769-L33ERMSK	1769-L36ERMS	1769-L37ERMS, 1769-L37ERMSK	1769-L38ERMS, 1769-L38ERMSK	1768-L43S	1768-L45S
Available user memory	1 MB standard 0.5 MB safety	2 MB standard 1 MB safety	3 MB standard 1.5 MB safety	4 MB standard 1.5 MB safety	5 MB standard 1.5 MB safety	2 MB standard 0.5 MB safety	3 MB standard 1 MB safety
Communication options	<ul style="list-style-type: none"> <li>Dual-port EtherNet/IP (standard and safety)</li> <li>DeviceNet (standard)</li> </ul>					<ul style="list-style-type: none"> <li>EtherNet/IP (standard and safety)</li> <li>ControlNet (standard and safety)</li> <li>DeviceNet (standard)</li> </ul>	<ul style="list-style-type: none"> <li>EtherNet/IP (standard and safety)</li> <li>ControlNet (standard and safety)</li> <li>DeviceNet (standard)</li> </ul>
Programming languages	<ul style="list-style-type: none"> <li>Standard task: all languages</li> <li>Safety task: relay ladder, safety application instructions</li> </ul>						



## Armor CompactLogix and Armor Compact GuardLogix Integrated Safety

The Armor CompactLogix and Armor Compact GuardLogix controllers extend the features of the CompactLogix 5370 and Compact GuardLogix 5370 controllers to On-Machine space.

The Armor Compact GuardLogix controllers deliver integrated safety control up to and including SIL 3, according to IEC 61508 and Ple/CAT. 4, according to ISO 13849-1.

Application	Description
SIL 1, 2, 3	<p>The Armor Compact GuardLogix controller system is type-approved and certified for use in safety applications up to and including SIL 3 according to IEC 61508, and applications up to and including Ple/Cat.4 according to ISO 13849-1. For more information, see:</p> <ul style="list-style-type: none"> <li>GuardLogix Controllers User Manual, publication <a href="#">1769-UM022</a>.</li> <li>GuardLogix 5570 and Compact GuardLogix 5370 Controller Safety Systems Safety Reference Manual, publication <a href="#">1756-RM099</a>.</li> <li>Compact GuardLogix Controllers User Manual, publication <a href="#">1768-UM002</a>.</li> <li>GuardLogix Safety Application Instruction Set Reference Manual, publication <a href="#">1756-RM095</a>.</li> </ul>

The Armor CompactLogix and Armor Compact GuardLogix controllers have the standard features of a CompactLogix controller. The Armor Compact GuardLogix controllers have the safety-related features of a Compact GuardLogix controller.

### Armor CompactLogix Controllers

Characteristic	1769-L33ERMO	1769-L36ERMO	1769-L37ERMO	1769-L38ERMO
Available user memory	2 MB	3 MB	4 MB	5 MB
Communication options	<ul style="list-style-type: none"> <li>Dual-port EtherNet/IP (standard and safety)</li> <li>DLR</li> </ul>			
Programming languages	<ul style="list-style-type: none"> <li>Standard task: all languages</li> </ul>			

### Armor Compact GuardLogix Controllers

Characteristic	1769-L33ERMOS	1769-L36ERMOS	1769-L37ERMOS	1769-L38ERMOS
Available user memory	<ul style="list-style-type: none"> <li>2 MB standard</li> <li>1 MB safety</li> </ul>	<ul style="list-style-type: none"> <li>3 MB standard</li> <li>1.5 MB safety</li> </ul>	<ul style="list-style-type: none"> <li>4 MB standard</li> <li>1.5 MB safety</li> </ul>	<ul style="list-style-type: none"> <li>5 MB standard</li> <li>1.5 MB safety</li> </ul>
Communication options	<ul style="list-style-type: none"> <li>Dual-port EtherNet/IP (standard and safety)</li> <li>DLR</li> </ul>			
Programming languages	<ul style="list-style-type: none"> <li>Standard task: all languages</li> <li>Safety task: relay ladder</li> </ul>			

# Local I/O Modules

These CompactLogix controllers support local I/O modules. The local I/O modules that are supported is different based on controller type.

Cat. No.	Local I/O Options
5069-L306ER, 5069-L306ERM, 5069-L310ER, 5069-L310ER-NSE, 5069-L310ERM, 5069-L310ERMK, 5069-L320ER, 5069-L320ERM, 5069-L320ERMK, 5069-L320ERP, 5069-L330ER, 5069-L330ERM, 5069-L330ERMK, 5069-L340ER, 5069-L340ERM, 5069-L340ERP, 5069-L350ERM, 5069-L350ERMK, 5069-L380ERM, 5069-L3100ERM	Compact 5000 I/O modules
5069-L306ERS2, 5069-L306ERMS2, 5069-L310ERS2, 5069-L310ERS2K, 5069-L310ERMS2, 5069-L310ERMS2K, 5069-L320ERS2, 5069-L320ERS2K, 5069-L320ERMS2, 5069-L320ERMS2K, 5069-L330ERS2, 5069-L330ERS2K, 5069-L330ERMS2, 5069-L330ERMS2K, 5069-L340ERS2, 5069-L340ERMS2, 5069-L350ERS2, 5069-L350ERS2K, 5069-L350ERMS2, 5069-L350ERMS2K, 5069-L380ERS2, 5069-L380ERMS2, 5069-L3100ERS2, 5069-L3100ERMS2	
5069-L306ERMS3, 5069-L310ERMS3, 5069-L310ERMS3K, 5069-L320ERMS3, 5069-L320ERMS3K, 5069-L330ERMS3, 5069-L330ERMS3K, 5069-L340ERMS3, 5069-L350ERMS3, 5069-L350ERMS3K, 5069-L380ERMS3, 5069-L3100ERMS3	
5069-L430ERMW, 5069-L450ERMW, 5069-L4100ERMW, 5069-L4200ERMW	
1769-L16ER-BB1B, 1769-L18ER-BB1B, 1769-L18ERM-BB1B, 1769-L18ERM-BB1BK, 1769-L19ER-BB1B, 1769-L19ER-BB1BK	Embedded I/O modules 1734 POINT I/O modules
1769-L24ER-QB1B, 1769-L24ER-QBFC1B, 1769-L24ER-QBFC1BK, 1769-L27ERM-QBFC1B	Embedded I/O modules 1769 Compact I/O modules
1769-L30ER, 1769-L30ERK, 1769-L30ERM, 1769-L30ERMK, 1769-L30ER-NSE, 1769-L33ER, 1769-L33ERK, 1769-L33ERMK, 1769-L33ERM, 1769-L36ERM, 1769-L37ERM, 1769-L37ERMK, 1769-L38ERM, 1769-L38ERMK	1769 Compact I/O modules
1769-L30ERMS, 1769-L33ERMS, 1769-L33ERMSK, 1769-L36ERMS, 1769-L37ERMS, 1769-L37ERMSK, 1769-L38ERMS, 1769-L38ERMSK	1769 Compact I/O modules

## Compact 5000 I/O Modules

You can install Compact 5000 I/O modules as local I/O modules in a CompactLogix 5380, Compact GuardLogix 5380, or CompactLogix 5480 control system.

The Compact 5000 I/O architecture provides a wide range of input and output modules to span many applications, from high-speed digital to process control. The architecture uses Producer/Consumer technology that allows input information and output status to be shared among multiple Logix 5000 controllers.

The Compact 5000 I/O modules are installed to the right of a CompactLogix 5380, Compact GuardLogix 5380, or CompactLogix 5480 controller and require removable terminal blocks (RTBs) to connect field-side wiring. The RTBs that are used with Compact 5000 I/O modules are sold separately. See [Removable Terminal Blocks on page 30](#) for the RTBs that are available for Compact 5000 I/O modules.

You can use Compact 5000 I/O safety modules with Compact GuardLogix 5380 controllers only. You cannot use them with CompactLogix 5380 or 5480 controllers.

The modules draw system-side power, which is known as Module (MOD) power, and field-side power, which is known as Sensor/Actuator (SA) power from the controller through the system backplane as needed. The modules then pass the remaining power to the next module in the system.

The following apply when you use Compact 5000 I/O modules:

- You cannot use Compact 5000 I/O modules with the other CompactLogix controllers.
- Some restrictions that apply when you use Compact 5000 I/O modules with Compact GuardLogix 5380 controllers. For more information, see the CompactLogix 5380 and Compact GuardLogix Controllers User Manual, publication [5069-UM001](#) and the Compact 5000 I/O Digital Modules User Manual, publication [5069-UM004](#).

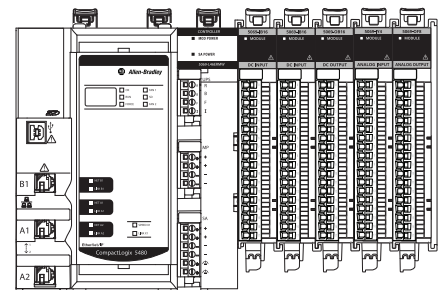
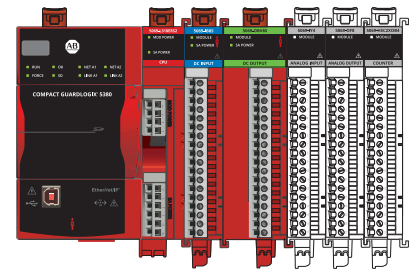
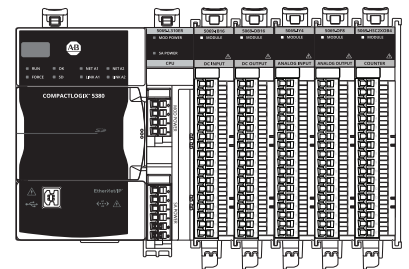

## Compact 5000 I/O DC Digital Modules

Cat. No.	Inputs/Outputs	Voltage Category	MOD Current, Max	SA Power Current, Max
5069-IB16, 5069-IB16K	16 inputs, sink	24V DC	75 mA	200 mA
5069-IB16F				
5069-IB6F-3W	6 inputs, sink			150 mA per channel 900 mA module
5069-OB16, 5069-OB16K	16 outputs, source			Local Actuator (LA) Power Current <sup>(1)</sup> 0.5 A per channel 8 A module
5069-OB16F				
5069-OB8	8 outputs (2 groups of 4)	LA Power Current <sup>(1)</sup> 2 A per channel 8 A per group 16 A per module		

(1) The module does not draw current from the SA power bus that is internal to the system. Local Actuator (LA+ and LA-) connections are used to supply field-side power to the module.

## Compact 5000 I/O AC Digital Modules

Cat. No.	Inputs/Outputs	Voltage Category	MOD Current, Max	SA Power Current, Max
5069-IA16	16 inputs	120/240V AC	75 mA	240 mA
5069-OA16	16 outputs	120/240V AC	100 mA	4 A

## Compact 5000 I/O Relay Output Modules

Cat. No. <sup>(1)</sup>	Outputs	Output Voltage Range	Module Power Current, Max	Sensor Actuator Power Current, Max
5069-OW4 <sup>(2)</sup>	4 - Form A (normally open)	5...125V DC 5...264V AC	75 mA	-
5069-OW16 <sup>(2)</sup>	2 groups of 8 - Form A (normally open)	5...125V DC 5...264V AC		150 mA
5069-OX4 <sup>(2)</sup>	4 - Form C (SPDT)	5...125V DC 5...264V AC		-

(1) 5069 relay modules are DC-type modules that require 24VDC power to the module. The relay modules can drive both AC and DC outputs. For power information, see the Compact 5000 I/O Modules and EtherNet/IP Adapters Technical Data, publication [5069-TD001](#).

(2) **Surge Suppression** - Connecting surge suppressors across your external inductive load extends the life of the module. For additional details, see the Industrial Automation Wiring and Grounding Guidelines, Allen-Bradley® publication [1770-4.1](#).

## Compact 5000 I/O Analog, Resistance, and Temperature Modules

Cat. No.	Inputs/Outputs	Range	Resolution	Module Power Current, Max	Sensor Actuator Power Current, Max
5069-IF8	8 differential	Voltage ±10V 0...10V 0...5V Current 0...20 mA 4...20 mA	±10.5V: <320 µV/count (15 bits plus sign bipolar) 0...10.5V: <160 µV/count (16 bits unipolar) 0...5.25V: <80 µV/count (16 bits unipolar) 0...21 mA: <0.32 µA/count (16 bits) 3.6...21 mA: <0.27 µA/count (16 bits)	75 mA	100 mA
5069-IY4, 5069-IY4K	4 differential, RTD, Thermocouple	Voltage ±10V 0...10V 0...5V	±10.5V: <320 µV/count (15 bits plus sign bipolar) 0...10.5V: <160 µV/count (16 bits unipolar) 0...5.25V: <80 µV/count (16 bits unipolar)		
		Current 0...20 mA 4...20 mA	0...21 mA: <0.32 µA/count (16 bits) 3.6...21 mA: <0.27 µA/count (16 bits)		
		RTD <sup>(1)</sup> (Input types PT 385, PT 3916, CU 427, NI 618, NI 672 available) 1...500 Ω 2...1000 Ω 4...2000 Ω 8...4000 Ω	< 7.9 mΩ/cnt in 1...500 Ω mode < 15.8 mΩ/cnt in 2...1000 Ω mode < 31.7 mΩ/cnt in 4...2000 Ω mode < 63.4 mΩ/cnt in 8...4000 Ω mode		
Thermocouple (Input types B, C, D, E, J, K, N, R, S, T, TXK/XK (L) available) ±100 mV	< 3.1 µV/cnt in ±100 mV mode				
5069-OF4, 5069-OF4K	4 current or voltage	Voltage ± 10V 0...10V 0...5V Current 0...20 mA 4...20 mA	16 bits across ± 10.5V - 320 µV/bit 16 bits across 10.5V - 160 µV/bit 16 bits across 5.25V - 80 µV/bit 16 bits across 21 mA - 320 nA/bit	75 mA	150 mA
5069-OF8	8 current or voltage	Voltage ± 10V 0...10V 0...5V Current 0...20 mA 4...20 mA	16 bits across ± 10.5V - 320 µV/bit 16 bits across 10.5V - 160 µV/bit 16 bits across 5.25V - 80 µV/bit 16 bits across 21 mA - 320 nA/bit		

(1) Operating in 3-wire mode.

## Compact 5000 I/O Safety Modules

Cat. No.	Inputs/Outputs	Voltage Category	MOD Current, Max	SA Power Current, Max
5069-IB8S, 5069-IB8SK	8 inputs, sink	24V DC	75 mA	80 mA
5069-OBV8S, 5069-OBV8SK	8 outputs (used as bipolar or sourcing outputs)	24V DC	75 mA	Local Actuator (LA) Power Current <sup>(1)</sup> 0.5 A per channel 8 A module

(1) The module does not draw current from the SA power bus that is internal to the system. Local Actuator (LA+ and LA-) connections are used to supply field-side power to the module.

## Compact 5000 I/O EtherNet/IP Adapters

Cat. No.	Description	Module Power Current, Max	Sensor Actuator Power Current, Max
5069-AENTR, 5069-AENTRK	The adapter connects remote Compact 5000 I/O modules, to star, linear, and DLR EtherNet/IP network topologies.	220 mA	5 mA (DC power) 2 mA (AC power)
5069-AEN2TR		450 mA	10 mA (DC power) 25 mA (AC power)

## Compact 5000 I/O Specialty Modules

Cat. No.	Description	Module Power Current, Max	Sensor Actuator Power Current, Max
5069-HSC2X0B4	Compact 5000 I/O high-speed counter module	50 mA	3 A <sup>(1)</sup>
5069-SERIAL	Compact 5000 I/O serial module	100 mA	Not Applicable
5069-ARM	Compact 5000 I/O address reserve module	45 mA	Not Applicable
5069-FPD	Compact 5000 I/O field potential distributor	Not Applicable	10 mA (DC power) 25 mA (AC power)

(1) SA power current is drawn only when the embedded output channels are used.

For more information on how to use local Compact 5000 I/O modules, see the following:

- Compact 5000 I/O Digital and Safety Modules in Logix 5000 Control Systems User Manual, publication [5069-UM004](#)
- Compact 5000 I/O Analog Modules in Logix 5000 Control Systems User Manual, publication [5069-UM005](#)
- Compact 5000 I/O High-speed Counter Modules in Logix 5000 Control Systems User Manual, publication [5069-UM006](#)

## Compact 5000 I/O End Caps

The right-most Compact 5000 I/O module in a CompactLogix 5380 or CompactLogix 5480 control system requires an end cap. The end cap catalog number is 5069-ECR. An end cap ships with the CompactLogix 5380, Compact GuardLogix 5380, CompactLogix 5480 controllers, and Compact 5000 I/O EtherNet/IP adapters. You do not need to order one separately. However, you can order replacement 5069-ECR end caps.

## Removable Terminal Blocks

You must order removable terminal blocks (RTBs) for the CompactLogix 5380 and Compact GuardLogix 5380 controllers, and Compact 5000 Adapters and I/O modules, separately. The RTBs are used to connect wiring to the controllers and I/O modules. The following table describes the RTBs.

Cat. Nos.	Device Supported	Description
5069-RTB14CJC-SCREW <sup>(1)</sup>	Compact 5000 I/O module	14-pin screw type terminal block with embedded CJC thermistors
5069-RTB14CJC-SPRING <sup>(1)</sup>		14-pin spring type terminal block with embedded CJC thermistors
5069-RTB18-SCREW		18-pin screw type terminal block
5069-RTB18-SPRING		18-pin spring type terminal block
5069-RTB6-SCREW	5069-FPD module	6-pin screw type terminal block
5069-RTB6-SPRING		6-pin spring type terminal block
5069-RTB64-SCREW	CompactLogix 5380 and Compact GuardLogix 5380 controllers 5069-AEN2TR EtherNet/IP adapter	4 and 6-pin screw type terminal block
5069-RTB64-SPRING		4 and 6-pin spring type terminal block
5069-RTB5-SCREW	5069-AENTR EtherNet/IP adapter	5-pin screw type terminal block
5069-RTB5-SPRING		5-pin spring type terminal block

(1) Applies to 5069-IY4 module only.

The CompactLogix 5480 controllers use RTBs for power supply connections.

## 1734 POINT I/O Modules

Additional 1734 POINT I/O modules can be installed on a CompactLogix 5370 L1 controller. The POINT I/O family is ideal for applications where flexibility and low cost of ownership are key for successful control system design and operation.

An RTB provides the wiring and terminations for field-side connections, and system power for the backplane.

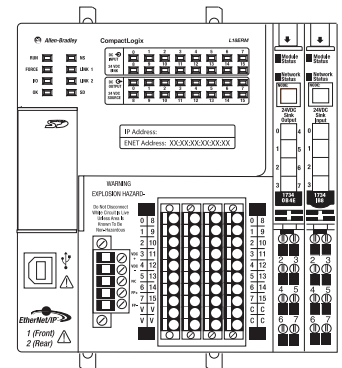

## 1734 AC Digital Modules

Cat. No.	Inputs/Outputs	Voltage Category	Wiring Base	POINTBus™ Current @ 5V DC
1734-IA2	2 inputs, nonisolated, sink	120V AC	1734-TB, 1734-TBS, 1734-TOP, 1734-TOPS	75 mA
1734-IA4	4 inputs, nonisolated, sink			
1734-IM2	2 inputs, nonisolated, sink	220V AC		
1734-IM4	4 inputs, nonisolated, sink			
1734-OA2	2 outputs, nonisolated, source	120/220V AC		
1734-OA4	4 outputs, nonisolated, source			

## 1734 DC Digital Modules

Cat. No.	Inputs/Outputs	Voltage Category	Wiring Base	POINTBus Current @ 5V DC	
1734-IB2	2 inputs, sink	24V DC	1734-TB, 1734-TBS, 1734-TOP, 1734-TOPS	75 mA	
1734-IB4	4 inputs, sink				
1734-IB4D	4 inputs, sink, diagnostic	24V DC		50 mA	
1734-IB8	8 inputs, sink	24V DC		75 mA	
1734-IB8S	8 inputs, sink, safety	24V DC	1734-TB, 1734-TBS, 1734-TOP, 1734-TOPS, 1734-TOP3, 1734-TOP3S	175 mA	
1734-IV2	2 inputs, source	24V DC	1734-TB, 1734-TBS, 1734-TOP, 1734-TOPS	75 mA	
1734-IV4	4 inputs, source				
1734-IV8	8 inputs, source				
1734-OB2	2 outputs, nonisolated, source	12/24V DC		1734-TB, 1734-TBS, 1734-TOP, 1734-TOPS	75 mA
1734-OB2E	2 outputs, nonisolated protected, source				
1734-OB2EP	2 outputs, nonisolated protected, source				
1734-OB4	4 outputs, nonisolated, source				
1734-OB4E	4 outputs, nonisolated protected, source				
1734-OB8	8 outputs, nonisolated, source				
1734-OB8E	8 outputs, nonisolated protected, source				
1734-OB8S	8 outputs, safety	24V DC	1734-TB, 1734-TBS, 1734-TOP, 1734-TOPS, 1734-TOP3, 1734-TOP3S		190 mA
1734-OV2E	2 outputs, nonisolated protected, sink	12/24V DC	1734-TB, 1734-TBS, 1734-TOP, 1734-TOPS		75 mA
1734-OV4E	4 outputs, nonisolated protected, sink				
1734-OV8E	8 outputs, nonisolated protected, sink				

## 1734 Relay Contact Output Modules

Cat. No.	Inputs/Outputs	Voltage Range	Wiring Base	POINTBus Current @ 5V DC
1734-OW2	2 Form A (normally open) relays	5...28.8V DC @ 2.0 A 48V DC @ 0.5 A 125V DC @ 0.25 A 125V DC @ 2.0 A 240V AC @ 2.0 A	1734-TB, 1734-TBS, 1734-TOP, 1734-TOPS	80 mA
1734-OW4	4 Form A (normally open) relays			
1734-OX2	2 Form C isolated (normally open; normally closed) electromechanical relays			100 mA

## 1734 Analog and Temperature Modules

Cat. No.	Inputs/Outputs	Range	Resolution	Wiring Base	POINTBus Current @ 5V DC
1734-IE2C	2 single-ended, nonisolated, current	4...20 mA 0...20 mA	16 bits over 0...21 mA 0.32 $\mu$ A/cnt	1734-TB, 1734-TBS, 1734-TOP, 1734-TOPS	75 mA
1734-IE2V	2 single-ended, nonisolated, voltage	0...10V (-0.0V under, +0.5V over) $\pm$ 10V (-0.5V under, +0.5V over)	15 bits plus sign 320 $\mu$ V/cnt in unipolar or bipolar mode		
1734-IE4C	4 single-ended, nonisolated, current	4...20 mA 0...20 mA	16 bits - over 0...21 mA 0.32 $\mu$ A/cnt		
1734-IE4S	4 inputs, single-ended, Safety rated	0...20 mA, 4...20 mA $\pm$ 5V, 0...5V, $\pm$ 10V, 0...10V	12 bits	1734-TB, 1734-TBS, 1734-TOP, 1734-TOPS, 1734-TOP3, 1734-TOP3S	110 mA
1734-IE8C	8 single-ended, nonisolated, current	4...20 mA 0...20 mA	16 bits - over 0...21 mA 0.32 $\mu$ A/cnt	1734-TB, 1734-TBS, 1734-TOP, 1734-TOPS	75 mA
1734-IR2	2 single-ended, nonisolated	0...600 $\Omega$	16 bits 9.5 m $\Omega$ /cnt 0.03 $^{\circ}$ C/cnt (Pt385 @ 25 $^{\circ}$ C) [0.05 $^{\circ}$ F/cnt (Pt385 @ 77 $^{\circ}$ F)]		
1734-IR2E	2 single-ended, nonisolated, protected	0...220 $\Omega$	16 bits 2.4 m $\Omega$ /cnt 0.006 $^{\circ}$ C/cnt (Pt385 @ 25 $^{\circ}$ C) [0.0114 $^{\circ}$ F/cnt (Pt385 @ 77 $^{\circ}$ F)]		
1734-IT2I	2 differential, individually isolated	Sensors B, C, E, J, K, N, R, S, T	15 bits plus sign 2.5 $\mu$ V/cnt	1734-TBCJC	175 mA
1734-OE2C	2 single-ended, nonisolated, current	4...20 mA 0...20 mA	13 bits over 0...21mA 2.5 $\mu$ A/cnt (average) 3...2.7 $\mu$ A/cnt (typical range)	1734-TB, 1734-TBS, 1734-TOP, 1734-TOPS	75 mA
1734-OE2V	2 single-ended, nonisolated, voltage	0...10V (-0.0V under, +0.5V over) $\pm$ 10V (-0.5V under, +0.5V over)	14 bits (13 plus sign) 1.28 mV/cnt in unipolar or bipolar mode		
1734-OE4C	4 single-ended, nonisolated, current	4...20 mA 0...20 mA	16 bits over 0...21 mA 0.32 $\mu$ A/cnt)		

## 1734 Counter Modules

Cat. No.	Inputs/Outputs	Range	Frequency	Wiring Base	POINTBus Current @ 5V DC
1734-IJ	1 - 1 group of A/Areturn, B/Breturn and Z/Zreturn	5V DC	1.0 MHz counter and encoder X1 500 kHz encoder X2 (no filter) 250 kHz encoder X4 (no filter)	1734-TB, 1734-TBS, 1734-TB3, 1734-TB3S, 1734-TOP, 1734-TOPS	160 mA
1734-IK	1 - 1 group of A/Areturn, B/Breturn and Z/Zreturn	15...24V DC			160 mA
1734-VHSC24	1 - 1 group of A/Areturn, B/Breturn and Z/Zreturn	15...24V DC			180 mA
1734-VHSC5	1 - 1 group of A/Areturn, B/Breturn and Z/Zreturn	5V DC			180 mA

## 1734 Self-configurable Modules

Cat. No.	Inputs/Outputs	Voltage Category	Wiring Base	POINTBus Current @ 5V DC
1734-8CFG	8 self-configurable	24V DC	1734-TB, 1734-TBS, 1734-TOP, 1734-TOPS	100 mA



## 1734 Communication and Specialty Modules

Cat. No.	Description	Wiring Base	POINTBus Current
1734-AENT	The single port adapter connects POINT I/O modules to the Ethernet network.	Not Applicable	
1734-AENTR	The adapter connects POINT I/O modules to a linear or DLR network and uses two copper network ports to connect to the network.	Not Applicable	
1734-232ASC 1734-485ASC	The 1734-232ASC and 1734-485ASC serial interface modules offer a serial-link communication interface solution for peripheral products with RS-232 (only 1734-232ASC), RS-485, and RS-422 ports (only 1734-485ASC.)	1734-TB, 1734-TBS, 1734-TOP, 1734-TOPS	75 mA
1734-ARM	The 1734-ARM address reserve module reserves the address and slot numbers to maintain a numbering scheme of a system. The 1734-ARM has no module configuration and does not communicate I/O data.		75 mA
1734-CTM 1734-VTM	The common terminal module (1734-CTM) and voltage terminal module (1734-VTM) expand the termination capabilities of POINT I/O modules. Install the modules to support higher density (8 channel) POINT I/O modules.		75 mA
1734-SSI	The 1734-SSI module collects serial data from absolute-position, encoding sensors that use standard serial synchronous interface (SSI) protocol.		110 mA

## 1769 Compact I/O Modules

The 1769 Compact I/O modules can be used as local I/O modules with these controllers:

- CompactLogix 5370 L2 controllers
- CompactLogix 5370 L3 controllers
- Compact GuardLogix 5370 controllers
- 1768 CompactLogix controllers

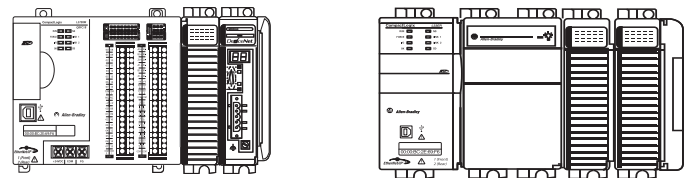

The modules mechanically lock together with a tongue-and-groove design and have an integrated communication bus that is connected from module to module by a moveable bus connector.

Each I/O module includes a built-in removable terminal block with fingersafe cover for connections to I/O sensors and actuators. The terminal block is behind a door at the front of the module. I/O wiring can be routed from beneath the module to the I/O terminals.

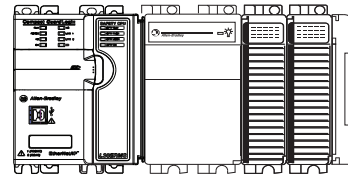

For detailed specifications, see 1769 Compact I/O Modules Specifications Technical Data, publication [1769-TD006](#).

## Power Supply Distance Ratings

Check the specification table of each module for the power supply distance rating. This rating indicates how many slot positions the module can be from the power supply.

## 1769 AC Digital Modules

Cat. No.	Inputs/Outputs	Voltage Category	Operating Voltage Range	Backplane Current	Power Supply Distance Rating
1769-IA8I 1769-IA8IK <sup>(2)</sup>	8 inputs, individually isolated	100/120V AC	79...132V AC, 47...63 Hz	90 mA @ 5.1V <sup>(1)</sup>	8
1769-IA16 1769-IA16K <sup>(2)</sup>	16 inputs	100/120V AC	79...132V AC, 47...63 Hz	115 mA @ 5.1V	8
1769-IM12	12 inputs	200/240V AC	159...265V AC, 47...63 Hz	100 mA @ 5.1V	8
1769-OA8	8 outputs	100/240V AC	85...265V AC 47...63 Hz	145 mA @ 5.1V	8
1769-OA16 1769-OA16K <sup>(2)</sup>	16 outputs	100/240V AC	85...265V AC 47...63 Hz	225 mA @ 5.1V	8

(1) Maximum is 190 mA.

(2) Module has conformal coating.

## 1769 DC Digital Modules

Cat. No.	Inputs/Outputs	Voltage Category	Operating Voltage Range	Backplane Current	Power Supply Distance Rating
1769-IG16	16 inputs	5V DC TTL	4.5...5.5V DC	120 mA @ 5.1V	8
1769-IQ16 1769-IQ16K <sup>(1)</sup>	16 inputs	24V DC sink/source	10...30V DC @ 30 °C (86 °F) 10...26.4V DC @ 60 °C (140 °F)	115 mA @ 5.1V	8
1769-IQ16F	16 inputs, high speed	24V DC sink/source	10...30V DC @ 30 °C (86 °F) 10...26.4V DC @ 60 °C (140 °F)	100 mA @ 5.1V	8
1769-IQ32 1769-IQ32K <sup>(1)</sup>	32 inputs	24V DC sink/source	10...30V DC @ 30 °C (86 °F) 10...26.4V DC @ 60 °C (140 °F)	170 mA @ 5.1V	8
1769-IQ32T	32 inputs	24V DC sink/source	20.4...26.4V DC @ 60 °C (140 °F)	170 mA @ 5.1V	8
1769-IQ6XOW4	6 inputs 4 outputs	24V DC sink/source input AC/DC normally open relay contact outputs	10...30V DC @ 30 °C (86 °F) 10...26.4V DC @ 60 °C (140 °F)	105 mA @ 5.1V 50 mA @ 24V	8
1769-OB8 1769-OB8K <sup>(1)</sup>	8 outputs	24V DC source	20.4...26.4V DC	145 mA @ 5.1V	8
1769-OB16 1769-OB16K <sup>(1)</sup>	16 outputs	24V DC source	20.4...26.4V DC	200 mA @ 5.1V	8
1769-OB16P	16 outputs, protected	24V DC source	20.4...26.4V DC	160 mA @ 5.1V	8
1769-OB32 1769-OB32K <sup>(1)</sup>	32 outputs	24V DC source	20.4...26.4V DC	300 mA @ 5.1V	6
1769-OB32T	32 outputs	24V DC source	10.2...26.4V DC	220 mA @ 5.1V	8
1769-OG16	16 outputs	5V DC TTL	4.5...5.5V DC	200 mA @ 5.1V	8
1769-OV16	16 outputs	24V DC sink	20.4...26.4V DC	200 mA @ 5.1V	8
1769-OV32T	32 outputs	24V DC sink	10.2...26.4V DC	300 mA @ 5.1V	8

(1) Module has conformal coating.

## 1769 Contact Output Modules

Cat. No.	Inputs/Outputs	Operating Voltage Range	Backplane Current	Power Supply Distance Rating
1769-OW8	8 outputs	5...265V AC 5...125V DC	125 mA @ 5.1V 100 mA @ 24V	8
1769-OW8I 1769-OW8IK <sup>(1)</sup>	8 outputs, individually isolated	5...265V AC 5...125V DC	125 mA @ 5.1V 100 mA @ 24V	8
1769-OW16 1769-OW16K <sup>(1)</sup>	16 outputs	5...265V AC 5...125V DC	205 mA @ 5.1V 180 mA @ 24V	8

(1) Module has conformal coating.

## 1769 Analog Modules

Cat. No.	Inputs/Outputs	Range	Resolution	Backplane Current	Power Supply Distance Rating
1769-IF4 1769-IF4K <sup>(1)</sup>	4 inputs, differential or single-ended	±10V 0...10V 0...5V 1...5V 0...20 mA 4...20 mA	14 bits (unipolar) 14 bits plus sign (bipolar)	120 mA @ 5.1V 60 mA @ 24V	8
1769-IF4I 1769-IF4IK <sup>(1)</sup>	4 inputs, differential or single-ended, individually isolated	±10V 0...10V 0...5V 1...5V 0...20 mA 4...20 mA	16 bits (unipolar) 15 bits plus sign (bipolar)	145 mA @ 5.1V 125 mA @ 24V	8
1769-IF8 1769-IF8K <sup>(1)</sup>	8 inputs, differential or single-ended	±10V 0...10V 0...5V 1...5V 0...20 mA 4...20 mA	16 bits (unipolar) 15 bits plus sign (bipolar)	120 mA @ 5.1V 70 mA @ 24V	8
1769-IF16C 1769-IF16CK <sup>(1)</sup>	16 inputs, single-ended	0...20 mA 4...20 mA	16 bits (unipolar) 15 bits plus sign (bipolar)	190 mA @ 5.1V 70 mA @ 24V	8
1769-IF16V 1769-IF16VK <sup>(1)</sup>	16 inputs, single-ended	±10V 0...10V 0...5V 1...5V	16 bits (unipolar) 15 bits plus sign (bipolar)	190 mA @ 5.1V 70 mA @ 24V	8
1769-IF4XOF2 1769-IF4XOF2K <sup>(1)</sup>	4 inputs, differential or single-ended 2 outputs, single-ended	0...10V 0...20 mA	Input: 8 bits plus sign Output: 8 bits plus sign	120 mA @ 5.1V 160 mA @ 24V	8
1769-IF4FXOF2F	4 inputs, fast differential or single-ended 2 outputs, fast single-ended	±10V 0...10V 0...5V 1...5V 0...20 mA 4...20 mA	Input: 14 bits (unipolar) 14 bits plus sign (bipolar) Output: 13 bits (unipolar) 13 bits plus sign (bipolar)	220 mA @ 5.1V 120 mA @ 24V	8
1769-OF2 1769-OF2K <sup>(1)</sup>	2 outputs, single-ended	±10V 0...10V 0...5V 1...5V 0...20 mA 4...20 mA	14 bits (unipolar) 14 bits plus sign (bipolar)	120 mA @ 5.1V 120 mA @ 24V	8

Cat. No.	Inputs/Outputs	Range	Resolution	Backplane Current	Power Supply Distance Rating
1769-OF4 1769-OF4K <sup>(1)</sup>	4 outputs, single-ended	±10V 0...10V 0...5V 1...5V 0...20 mA 4...20 mA	15 bits plus sign unipolar and bipolar	120 mA @ 5.1V 170 mA @ 24V	8
1769-OF4CI 1769-OF4CIK <sup>(1)</sup>	4 outputs, differential, individually isolated	0...20 mA 4...20 mA	16 bits (unipolar)	165 mA @ 5V 110 mA @ 24V	8
1769-OF4VI 1769-OF4VIK <sup>(1)</sup>	4 outputs, differential, individually isolated	±10V 0...10V 0...5V 1...5V	15 bits plus sign (bipolar)	145 mA @ 5.1V 75 mA @ 24V	8
1769-OF8C 1769-OF8CK <sup>(1)</sup>	8 outputs, single-ended	0...20 mA 4...20 mA	16 bits (unipolar)	140 mA @ 5.1V 145 mA @ 24V	8
1769-OF8V 1769-OF8VK <sup>(1)</sup>	8 outputs, single-ended	±10V 0...10V 0...5V 1...5V	16 bits plus sign (bipolar)	145 mA @ 5.1V 125 mA @ 24V	8

(1) Module has conformal coating.

## 1769 Analog RTD and Thermocouple Modules

Cat. No.	Inputs/Outputs	Sensors Supported	Backplane Current	Power Supply Distance Rating
1769-IR6 1769-IR6K <sup>(1)</sup>	6 RTD inputs	100, 200, 500, 1000 Ω Platinum 385 100, 200, 500, 1000 Ω Platinum 3916 120 Ω Nickel 618 120 Ω Nickel 672 10 Ω Nickel-iron 518 0...150 Ω 0...500 Ω 0...1000 Ω 0...3000 Ω	100 mA @ 5.1V 45 mA @ 24V	8
1769-IT6 1769-IT6K <sup>(1)</sup>	6 thermocouple inputs	Thermocouple types B, C, E, J, K, N, R, S, T ±50V ±100V	100 mA @ 5.1V 45 mA @ 24V	8 <sup>(2)</sup>

(1) Module has conformal coating.

(2) To reduce the effects of electrical noise, install the 1769-IT6 module at least two slots away from the AC power supplies.

## 1769 Communication and Specialty Modules

Cat. No.	Description	Backplane Current	Power Supply Distance Rating
1769-AENTR 1769-AENTRK <sup>(1)</sup>	The adapter connects 1769 Compact I/O modules to a linear or DLR network and uses two copper network ports to connect to the network.	500 mA @ 5V	5
1769-ARM	Use a 1769-ARM address reserve module to reserve module slots. After creating an I/O configuration and user program, you can remove and replace any I/O module in the system with a 1769-ARM module. You must first inhibit the removed module in the Logix Designer application.	60 mA @ 5.1V	8
1769-ASCII	The 1769-ASCII module, a general-purpose two-channel ASCII interface, provides a flexible network interface to a wide variety of RS-232, RS-485, and RS-422 ASCII devices. The module provides the communication connections to the ASCII device.	425 mA @ 5.1V	4
1769-BOOLEAN	Use the 1769-BOOLEAN module in applications that require repeatability, such as material handling and packaging, when there is a requirement to activate an output that is based on the transition of an input. If the Boolean expression is true, the output is directed to the ON state. If the Boolean expression is false, the output channel is directed to the OFF state. There are four operators that you can configure as OR, AND, XOR, or none.	220 mA @ 5.1V	8
1769-HSC	Use the 1769-HSC when you need: <ul style="list-style-type: none"> <li>• A counter module that can react to high-speed input signals.</li> <li>• To generate rate and time-between-pulses (pulse interval) data.</li> <li>• As many as two channels of quadrature or four channels of pulse/count inputs.</li> </ul>	245 mA @ 5.1V	4
1769-SM1	The Compact I/O to DPI™ or SCANport™ module connects to PowerFlex 7-class drives, other DPI-based host devices, and SCANport-based host devices such as 1305 and 1336 PLUS™ II drives.	280 mA @ 5.1V	6
1769-SM2	The Compact I/O to DSI/Modbus module connects to PowerFlex 4-class drives and to other Modbus RTU slave devices, such as PowerFlex 7-class drives with 20-COMM-H RS-485 HVAC adapters.	350 mA @ 5.1V	4

(1) Module has conformal coating.

## 1769 Expansion Cables

If you divide 1769 modules into multiple banks, make sure:

- Each bank needs its own power supply.
- To use expansion cables to connect the banks.
- The last I/O bank requires an end cap.

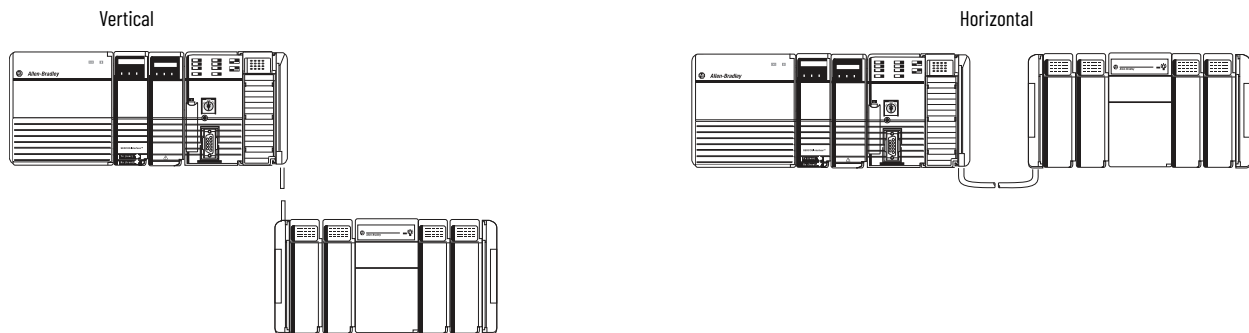

How you orient I/O banks determines the expansion cables that you must connect the I/O banks.

If You Add a	And Connect the Chassis	Use This Cable <sup>(1)</sup>
Second bank	Right to left	1769-CRL <sub>x</sub>
	Right to right	1769-CRR <sub>x</sub>
Third bank	Right to left	1769-CRL <sub>x</sub>
	Right to right	1769-CRR <sub>x</sub>
	Left to left	1769-CLL <sub>x</sub>

(1) Where  $x = 1$  for 1 ft (305 mm) or 3 for 3.28 ft (1 m).

## 1769 End Caps

The final 1769 Compact I/O bank requires an end cap on the end without the expansion cable. The CompactLogix 5370 L2 controller comes with a right-end cap, so you do not need to order one separately.

- Right end cap, catalog number 1769-ECR
- Right end cap with conformal coating, catalog number 1769-ECRK
- Left end cap, catalog number 1769-ECL
- Left end cap with conformal coating, catalog number 1769-ECLK

## 1769 Wiring Systems

As an alternative to buying removable terminal blocks (RTBs) and connecting the wires yourself, you can buy a wiring system of:

- Interface modules (IFMs) that provide the output terminal blocks for digital I/O modules. Use the prewired cables that match the I/O module to the IFM.
- Analog interface modules (AIFMs) that provide the output terminal blocks for analog I/O modules. Use the prewired cables that match the I/O module to the AIFM.
- I/O module-ready cables. One end of the cable assembly is an RTB that plugs into the front of the I/O module. The other end has individually color-coded conductors that connect to a standard terminal block.

## Removable Terminal Kits

You can order removable terminal kits with the CompactLogix 5370 L1 and L2 controllers separately. The kits are used to connect wiring to the controllers. The following table describes the kits.

Cat. Nos.	Controllers Supported	Description
1769-RTB45	CompactLogix 5370 L1	<ul style="list-style-type: none"><li>• Four 10-pin connectors that are used to connect wiring to the embedded digital I/O module of the controller.</li><li>• One 5-pin connector that is used to connect an external 24V DC power source to the controller.</li></ul>
1769-RTB40DIO	CompactLogix 5370 L2	Four 10-pin connectors that are used to connect wiring to the embedded digital I/O module of the controller.
1769-RTB40AIO	1769-L24ER-QBFC1B and 1769-L27ERM-QBFC1B	Four 10-pin connectors that are used to connect wiring to the embedded analog I/O module of the controller.

# CompactLogix Power Supplies

Select power supplies based on the controller and the number of additional I/O banks.

For a	Select
CompactLogix 5370 L3 controller	<ul style="list-style-type: none"> <li>One 1769 power supply for the controller and local I/O modules.</li> <li>One 1769 power supply for each additional bank of I/O modules.</li> </ul>
CompactLogix 5370 L2 controller	No power supply as it is integrated to the controller package.
CompactLogix 5370 L1 controller	No power supply as it is integrated to the controller package.
CompactLogix 5380 controller	None
Compact GuardLogix 5380 controller	<p>External power supplies must be used to transfer MOD power and SA power to the system. The external power supplies are connected to a MOD power RTB and an SA power RTB that is installed on the controller.</p> <p><b>IMPORTANT:</b> When you use Compact GuardLogix 5380 controllers, you must use SELV/PELV-rated power supplies for MOD power and SA power. Additionally, you can only use DC SA power with Compact GuardLogix 5380 controllers.</p>
CompactLogix 5480	<p>None</p> <p>External power supplies must be used to transfer MOD power and SA power to the system. The external power supplies are connected to a MOD power RTB and an SA power RTB that is installed on the controller.</p> <p>External uninterruptible power supply can be used to provide power to the UPS RTB that is installed on the controller. You can connect an external uninterruptible power supply (UPS) to the UPS RTB to save the program if power is lost.</p> <p><b>IMPORTANT:</b> The UPS lets the controller save the program but not the state of the program.</p> <p>We recommend that you use a 1606 switched mode uninterruptible power supply, for example, the 1606-XLS240-UPS power supply.</p>

## Power Supplies

Cat. No.	Description	Voltage Category	Operating Voltage Range
1769-PA2 1769-PA2K <sup>(1)</sup>	1769 Compact I/O expansion power supply	120V/220V AC	85...265V AC
1769-PB2 1769-PB2K <sup>(1)</sup>		24V DC	19.2...31.2V DC
1769-PA4 1769-PA4K <sup>(1)</sup>		120V/220V AC	85...265V AC or 170...265V AC (switch selectable) 47...63 Hz
1769-PB4 1769-PB4K <sup>(1)</sup>		24V DC	19.2...31.2V DC

(1) Module has conformal coating.

For detailed specifications, see Compact Power Supplies Specifications Technical Data, publication [1769-TD008](#).

---

**Notes:**



## Additional Resources

These documents contain additional information concerning related products from Rockwell Automation.

Resource	Description
Industrial Automation Wiring and Grounding Guidelines, publication <a href="#">1770-4.1</a>	Provides general guidelines for installing a Rockwell Automation industrial system.
Product Certifications website, <a href="#">rok.auto/certifications</a> .	Provides declarations of conformity, certificates, and other certification details.

You can view or download publications at [rok.auto/literature](#).

# Rockwell Automation Support

Use these resources to access support information.

<b>Technical Support Center</b>	Find help with how-to videos, FAQs, chat, user forums, and product notification updates.	<a href="http://rok.auto/support">rok.auto/support</a>
<b>Knowledgebase</b>	Access Knowledgebase articles.	<a href="http://rok.auto/knowledgebase">rok.auto/knowledgebase</a>
<b>Local Technical Support Phone Numbers</b>	Locate the telephone number for your country.	<a href="http://rok.auto/phonesupport">rok.auto/phonesupport</a>
<b>Literature Library</b>	Find installation instructions, manuals, brochures, and technical data publications.	<a href="http://rok.auto/literature">rok.auto/literature</a>
<b>Product Compatibility and Download Center (PCDC)</b>	Get help determining how products interact, check features and capabilities, and find associated firmware.	<a href="http://rok.auto/pcdc">rok.auto/pcdc</a>

## Documentation Feedback

Your comments help us serve your documentation needs better. If you have any suggestions on how to improve our content, complete the form at [rok.auto/docfeedback](http://rok.auto/docfeedback).

1336 PLUS, Allen-Bradley, Armor, Armor GuardLogix, Compact I/O, Compact 5000, CompactLogix, DPI, Encompass, expanding human possibility, FactoryTalk, GuardLogix, Integrated Architecture, Kinetix, Logix 5000, On-Machine, PanelView, PlantPAx, POINT I/O, POINTBus, PowerFlex, Rockwell Automation, SCANport, Stratix, and Studio 5000 Logix Designer are trademarks of Rockwell Automation, Inc.





Microsoft Windows is a trademark of Microsoft Corporation.

CIP, ControlNet, DeviceNet, and EtherNet/IP are trademarks of ODVA, Inc.

Trademarks not belonging to Rockwell Automation are property of their respective companies.

Rockwell Automation maintains current product environmental information on its website at [rok.auto/pec](http://rok.auto/pec).

Rockwell Otomasyon Ticaret A.Ş. Kar Plaza İş Merkezi E Blok Kat:6 34752, İçerenköy, İstanbul, Tel: +90 (216) 5698400 EEE Yönetmeliğine Uygundur

Connect with us.    

**rockwellautomation.com** ————— expanding **human possibility**<sup>™</sup>

AMERICAS: Rockwell Automation, 1201 South Second Street, Milwaukee, WI 53204-2496 USA, Tel: (1) 414.382.2000, Fax: (1) 414.382.4444

EUROPE/MIDDLE EAST/AFRICA: Rockwell Automation NV, Pegasus Park, De Kleetlaan 12a, 1831 Diegem, Belgium, Tel: (32) 2 663 0600, Fax: (32) 2 663 0640

ASIA PACIFIC: Rockwell Automation, Level 14, Core F, Cyberport 3, 100 Cyberport Road, Hong Kong, Tel: (852) 2887 4788, Fax: (852) 2508 1846