

Basic HMI

Advanced HMI

Industrial PC

Outdoor HMI

Pro-face Product Guide 2023

Find the best HMI from our wide range of products

proface.com

Pro-faceTM

by Schneider Electric

HMI Centric

Pro-face Industrial IoT solution

Reposition the human in the center of the automation architecture. Interactive and intuitive operations help to make sharp and timely decisions by everyone - everywhere. By connecting to devices from a plethora of manufacturers, we can discover new optimized solutions and configurations with peace of mind on the site. HMI with Visibility, Flexibility, and Reliability opens the window to information for you. HMI Centric Solutions make the best of the human workforce with digital technology.

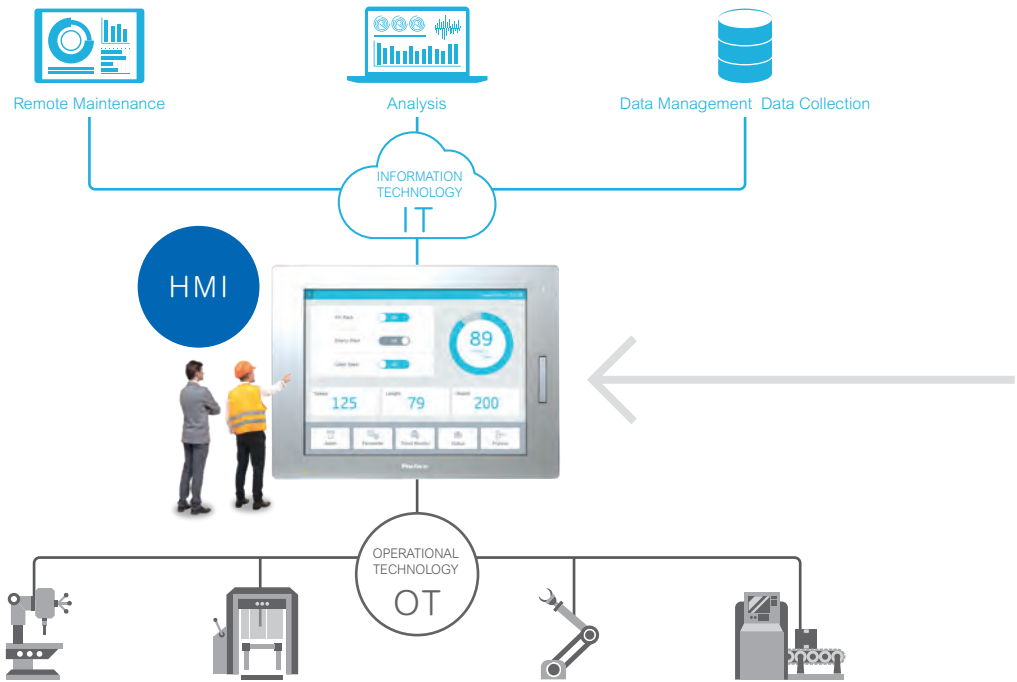

HMI Centric Solution for Semiconductor

As HMI specialists, we offer HMI Centric solutions to the semiconductor segments with Connectivity, Reliability, and Effectivity.

HMI Centric realizes Secure remote monitoring and smart operation on the facility for the semiconductor, especially for Water, Gases Supply Systems, Chemical, Wast Chemical, Exhaust, AMHS, and Cleanroom systems.

Use Cases

- Remote monitoring system
- Embedded Camera Application
- Thermal Camera Monitoring System
- Customization
- IRIS scanner
- Tablet for mobile HMI operation
- E-Mail transmission

Customer Story for semiconductor
Air Liquide Electronics
Systems Asia



 Download the Solution Guide to learn more about our products, application, use cases and more!

 web link

High Flexibility

Open Connectivity meets various needs



OT / IT Connectivity

Connect directly to a wide range of devices and networks with various vendors.



Offer Scalable and Customizable

A wide range of product lineup including modern technologies to meet the specific needs of various customers.



Collaborative System

Ready-to-use embedded HMI service to access machines remotely and securely.

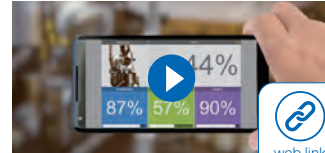

Simple Visibility

Empowered human workforce



Intuitive Layout Design

Everyone easily operate and access precise information in a fast HMI design.

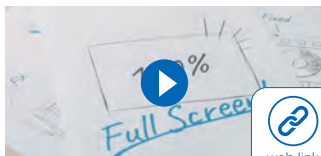

Increasing Information Value

Rich and expressive interfaces and intuitive operation in a large amount of data to utilize easily.



Modern Visualization

Supported by high-resolution graphics and tablet style displays with smooth response which Millennials favor.



Strong Reliability

Peace of mind on your site



Robust and cyber secure Solutions

Based on quality best practice since the world's first HMI (GP Series) was first developed in 1989.

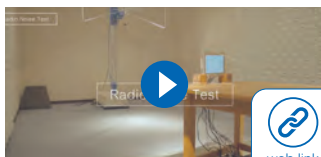

Global Availability / Support / Training

HMI Specialist service & support delivering certainty around the world.



Effortless migration to innovations

Special care to migrate our instrument to our new concept and to our new innovations.



HMI Centric Architecture



The proven solution to challenges associated with designing or developing your HMI project and data handling structures. Get started quickly by combining validated equipment with Pro-face HMI documented samples!

High Flexibility -Open Connectivity meets flexibly various needs-

Simple and easy data management using STM6000 Edge Box HMI with SQL database

STM6000 Edge Box HMI can communicate with multiple controllers simultaneously and supply data to the SQL database. It is a cost-effective and effortless transfer of data between the OT layer and IT enterprise systems. Start with simple and easy data management using STM6000 Edge Box HMI over 3G/4G using your smartphone as an access point, even in environments where a network cannot be built or the end user's on-site network is not available.



Secure remote access with 4G router without installed local network

Securely access your HMI and connected devices without the need for a dedicated VPN router. Pro-face Connect can enable the encrypted and IEC 62443-3-3 certified architecture, and manage users with different access levels can be managed centrally. Start flexible as well as an economical choice.

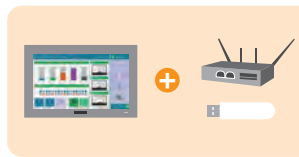

Enabling remote connection on the fly with your smartphone

You can easily start secure remote maintenance over 3G/4G using your smartphone as an access point, even in environments where a network cannot be built or the end user's on-site network is not available.

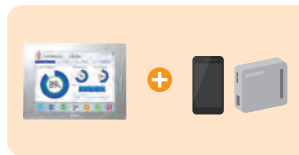

Enable remote monitoring service with Cloud application

Enable remote monitoring service with Cloud application. You can quickly start remote monitoring services using a popular cloud service, Amazon AWS, and Microsoft Azure.

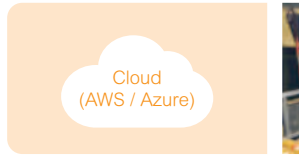

Simple Visibility -Empowered human workforce-

Enable new digital cloud-based services on your machine by STM6000 Edge Box HMI with EcoStruxure Machine Advisor

STM6000 Edge Box HMI with EcoStruxure Machine Advisor enables machine builders to provide new services to machine operators for each installed machine in any production site worldwide. Enable new digital cloud-based services on your machine by STM6000 Edge Box HMI with EcoStruxure Machine Advisor quickly.

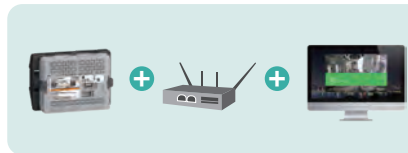

Modern maintenance system based on Augmented Reality (AR) with industrial PC and Software solutions.

You can introduce AR(Augmented Reality) technology to your factory quickly and start smart maintenance to improve maintenance operations easily.

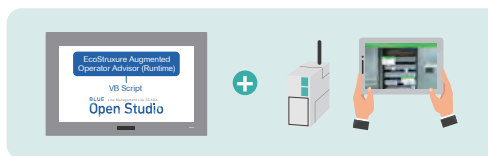

Traceability supported by RFID based identification

Enjoy traceability applications developed easily with program-less communication. The HMI communicates with RFID readers/writers via Modbus. This effective traceability and digitized production preparation.



Empower operators to improve your site with a network camera

Network cameras are attracting a lot of attention as a tool for site improvement, especially in large equipment and multifunctional machines. By capturing scenes that are not noticeable to the naked eye or the cause of errors that cannot be determined by data analysis alone, you will be able to reliably uncover facts that were previously unknown to you.

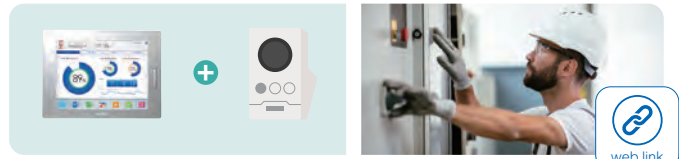

Information where you need with BOX HMI without the need of fixed mounted HMI

Use the full performance of your HMI projects on the move with the screenless BOX HMI that can be hidden in the electrical cabinet. Thanks to the Pro-face connectivity, you have access to important information of various equipment on your tablet or smartphone with all the convenience and features that a professional HMI does offer. In larger installations positions can be identified by QR codes making sure that the right information is available and that the right operations can be made.



Robot HMI

In the past, a robot technician had to use a special teaching pendant to determine the state of the robot and restore it when an error occurred. However, with dedicated sample screen is available to check the status of the robot on HMI. Robot HMI makes it easy for anyone to determine the status of the robot.



Strong Reliability -Peace of mind on your site-

Smart security on your machine with HMI + face recognition

Realize a touchless secure system with HMI. Easy to Login/Logout in a specific environment, such as Cleanroom/Dirty workplace/Oily workplace/Dangerous environment in which machine rotates. Start enhanced smart security.

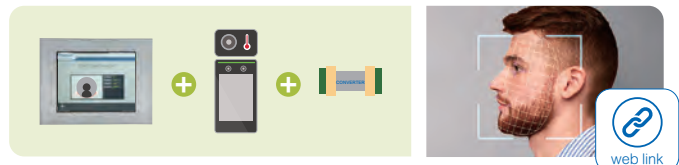

Reliable access management with ID Card (NFC) reader

Security measures can be easily implemented by utilizing HMI to manage the operations of equipment and facilities that are operated by multiple operators or that have special processes.



Collaboration

Reduce maintenance cost

HMI + Yaskawa

If you stand in front of the HMI, you can immediately check and set the status of the Robot / Servo / Machine Controller. Reduce the time to open the control panel and the time to adjust with a Teaching pendant or a PC!

Robot



Servo



Machine Controller

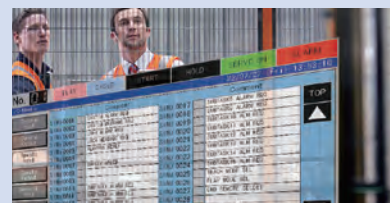

Efficient operation

HMI with IAI ELECYLINDER

Monitor and operate the [Simple Data Setting] screen of the Touch panel teaching pendant on Pro-face HMI. HMI can be used as a teaching pendant for IAI ELECYLINDER Operators can monitor not only the status of IAI devices on HMI but also PLC and other controllers' status on HMI, too



Pro-face Product Overview

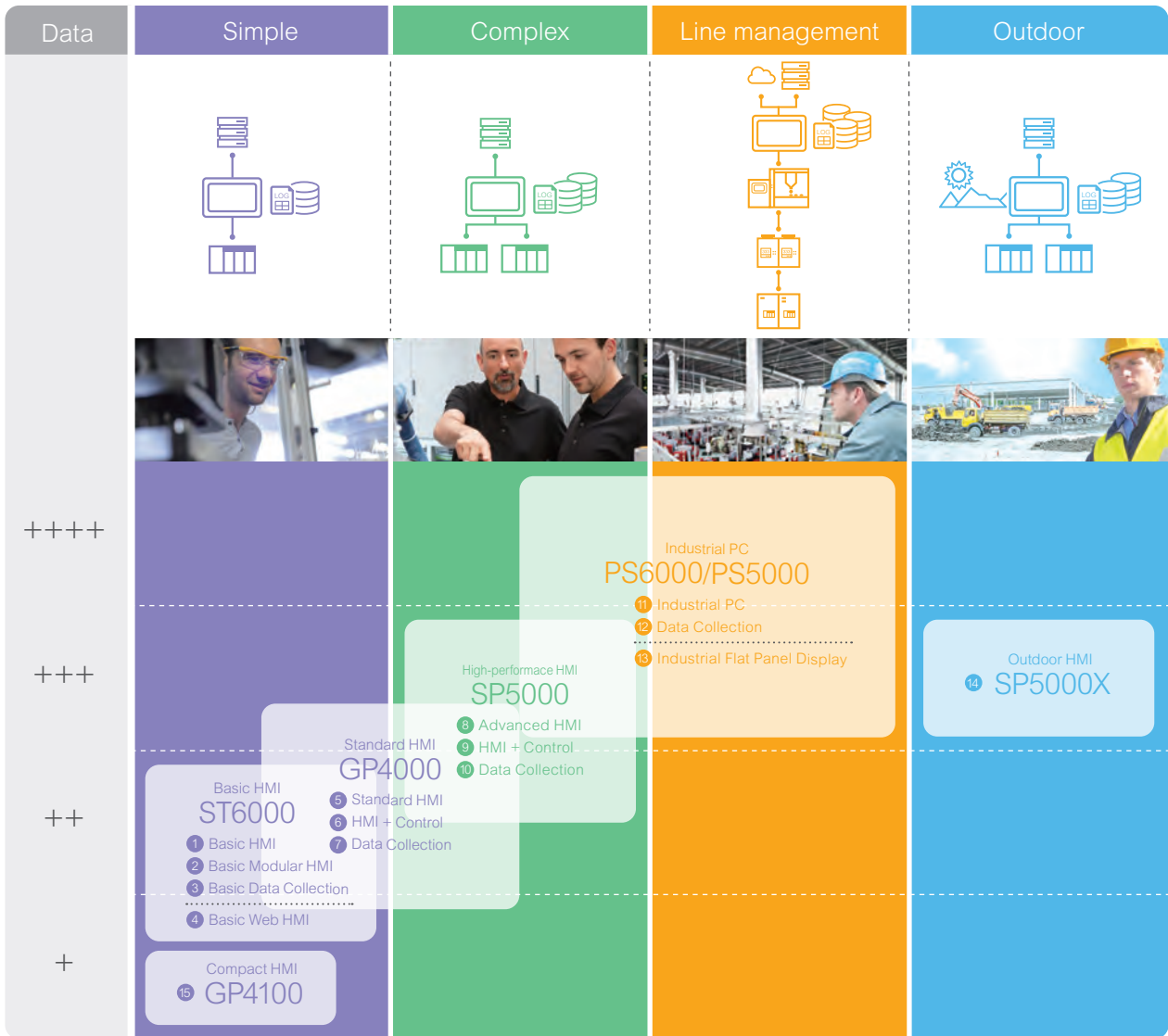

ST6000 Series BLUE VERSION UP GP-Pro EX VERSION UP

- 1 Basic HMI (ST6000)
- 2 Basic Modular HMI (STM6000)
- 3 Basic Data Collection (STM6000 Gateway)
- 4 Basic Web HMI (STW6000)

PS6000/PS5000 Series BLUE Line Management Live SCADA Open Studio VERSION UP

- 11 Industrial PC (PS6000 / PS5000)
- 12 Data Collection (PS6000/PS5000)
- 13 Industrial Flat Panel Display (FP6000 / SP5000 + option / PS5000 + option)

GP4000 Series GP-Pro EX VERSION UP

- 5 Standard HMI (GP4000)
- 6 HMI + Control (LT4000M)
- 7 Data Collection (LT4000M)

SP5000X Series GP-Pro EX VERSION UP







- 14 Outdoor HMI (SP5000X)

SP5000 Series GP-Pro EX VERSION UP

- 8 Advanced HMI (SP5000)
- 9 HMI + Control (SP5000+option)
- 10 Data Collection (SP5000+option)

GP4100 Series GP-Pro EX VERSION UP

- 15 Compact HMI (GP4100)

Specification		Simple			Complex	Line management	Outdoor
		 GP4100	 ST6000	 GP4000	 SP5000	 PS6000/PS5000	 SP5000X
Software		GP-Pro EX	BLUE	GP-Pro EX	GP-Pro EX	BLUE Open Studio	GP-Pro EX
Related Software / License	Remote Monitoring	Pro-face Remote HMI	Web Viewer License	Pro-face Remote HMI	Pro-face Remote HMI	Thin Client License	Pro-face Remote HMI
	Remote connection service	No	Pro-face Connect	Pro-face Connect	Pro-face Connect	Pro-face Connect	Pro-face Connect
Visualization	Size	4"w	4"w, 7"w, 10"w, 12"w, 15"w	3.5", 5.7", 7.5", 10.4", 12.1" 7"w	10", 12", 15" 7"w, 10"w, 12"w, 15"w, 19"w	12", 15" 10"w, 12"w, 15"w, 19"w, 22"w	7"w, 12"w, 15"w
	Display quality (Resolution, color)	++	++	+	++	+++	+++++ (Sunlight readable)
	Performance	Standard	Standard	Standard	High	High	High
Operation	Touch operation	+	+	+	++	+++	+
Connectivity	IT (Ethernet)	0 or 1	2 (4"w:1)	1	2	2	2
	OT (Serial, USB, Fieldbus)	+	++	++	+++	+++	+++
	I/O	No	No	Yes (Only LT4000M)	Yes (Only SP-5B10 + option)	Yes (Option)	Yes (Option)
	Data backup operation	+	+	++	++	+++	++
Data handling	Storage	0	SD x 1(Only 10.4") Local Storage (Only BLUE)	0 or SD x 1	SD x 1 or SD x 2	HDD/SSD x 1	SD x 2
Environment	Environment resistance	+	+	+	++	+	+++
	Certification (Haz Loc, ATEX, Marine)	+++	+	+++	+++	++	++
Features	Integrate Windows Apps	No	No	No	Yes (Only SP-5B41)	Yes	No
	IT connection (OPC, MQTT, Email, etc)	+	+++	++	++	++++	++



Industrial PC

PS6000 Series BLUE Line Management Lite SCADA Open Studio



Improve your productivity with the most reliable PC-based architecture experience.

New PS6000 from the HMI leader: Robust as a terminal, Open and High-performant as a PC, even more economical.

New Experience

01 New Experience for Automation Engineers

A rich modular catalog and a strong background of customization service.

To run any software, including pre-installed bundles.

Easily selected with new Product Configurator and with quick delivery.

Software

BLUE Line Management Lite SCADA **Open Studio** **Pro-face Connect** Secure Remote Access over Internet

AVEVA

Java .NET C++ Raid
Thin client Security MS Office etc.



BOX Core i7 Core i5 Celeron
Advanced Box
Standard Box Core i3

Display 12" 15" Resistive multi touch 4:3 wide
Capacitive multi touch 10" Wide 12" Wide 15" Wide 19" Wide 22" Wide

Options +
HDD / SSD Slot-in design Interfaces Slot-in design PCI / PCIe² Slots module

*1 10" Wide is available with only Standard Box.
*2 PCI / PCIe is supported for only Advanced Box.

02 A new Experience for Operators and Production Managers

High-performance with the latest CPU and Innovative display for smart manufacturing.

To run securely, on most demanding industrial environments.

Standard mode Glove mode Water Detection mode

Quickly change display type for operators situation with configuration.



03 A new Experience for Maintenance Specialists

Smart maintenance to reduce downtime and improve productivity.

Long Term Peace of Mind thanks to long availability, global support and training.

Long Availability

Quick Response Special Support Quick Deliver



Selection guide

Associated software can run on Pro-face Industrial PCs to make the next stage of your digital transformation.

	Combining with Pro-face Industrial PCs									
	Lite SCADA		Remote Visualization		HMI	Plant SCADA and Historian	Augmented Operator	IIoT solution	Secured Remote Connection	
Software name	 BLUE Open Studio		 Remote HMI Server		 BLUE Win GP	 AVEVA System Platform	 EcoStruxure Augmented Operator Advisor	 Node-RED	 Pro-face Connet	
Software runtime license for Industrial PC <Model No.>	1.5K tags <PFXBOSRT1KA>	32K tags <PFXBOSRT32KA>	Thin Client License <PFXBOSTCA>	Remote HMI Server Licesce <PFXEXRHLSL>	BLUE Runtime <PFXBLRCZLSPA31>	License from AVEVA distributor	Server License	-	Pro-face Connect License 30 days Free Trial <PFXCONFREE30>	
	4K tags <PFXBOSRT4KA>	64K tags <PFXBOSRT64KA>			WinGP <EX-WINGP-IPC>					
PS6000 Core i7 Core i5 Core i3	★★	★★★★	★★★★	★★★★	★★★★	★★★★	★★★★	★★★★	★★★★	★★★★
Configured To Order with software license + software pre-installed*				User install	User install	User install	User install	Installed by default	User install	
PS6000 Celeron	★★★★	★★	★★★★	★★	★★	★★	★★	★★★★	★★★★	
Configured To Order with software license + software pre-installed*				User install	User install	User install	User install	Installed by default	User install	
PS5000 Atom	★★	★	★★★★	★	★	★	★	★★★★	★★★★	
User install		User install		User install	User install	User install	User install	User install	User install	

* The installer of AVEVA System Platform can be found on the desktop. The selection of the software to be installed and related installation procedure is to be done by the user.
 * The license needs to be purchased separately from AVEVA / AVEVA Distributor. * For technical support related to AVEVA software, please contact AVEVA / AVEVA local Distributor.

PS6000 Customer Story



Pharmaceutical – IRM Enterprises

IRM manufactures tablet presses, capsule filling machines, and granulation equipment for pharmaceutical, nutraceutical, and aligned industries. And have over 40 years, supplied more than 5000 machines in over 60 countries across the globe. IRM manufacturers selected Pro-face based on three criteria. The first reason is versatility. The second reason is reliability. The third reason is the support system.





website



video



manual



configurator



CAD



software

Rich options to meet your needs, easily selected with a new Product Configurator with quick delivery.



PCI/PCIe*1 Slot module



Advanced box



Interfaces Slot-in design



Display

Front USB

Resistive Multi-touch

4:3

12"

15"

Capacitive +Glasstop Multi-touch with optimized noise filter

wide

10" Wide*2

12" Wide

15" Wide

19" Wide

22" Wide

Touch Mode Configuration

HDD/SSD Slot-in design

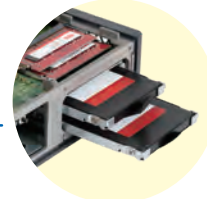

Interfaces	
Product Name	Model No.
2 x RS-232C Isolated	PFXYP6MPR23P2
4 x RS-232C	PFXYP6MPR23P4
2 x RS422 / 485 Isolated	PFXYP6MPR42P2
16DI / 8DO	PFXYP6MPX16Y8
Ethernet (GbE IEEE1588)	PFXYP6MPETH
Audio	PFXYP6MPAU
4G Cellular for US	PFXYP6MP4GU
4G Cellular for EU / Asia / Japan	PFXYP6MP4GE
EtherCAT	PFXYP6MPECAT
WiFi / Bluetooth	PFXYP6MPWF



WiFi / Bluetooth



16DI / 8DO



2 x RS-232C Isolated



Audio



EtherCAT



Ethernet (GbE IEEE1588)

2 x RS-232C Isolated	
Product Name	Model No.
M.2 SSD 128GB (Standard Endurance)	PFXYP6M2128L
M.2 SSD 128GB (High Endurance)	PFXYP6M2128
M.2 SSD 256GB (High Endurance)	PFXYP6M2256
M.2 SSD 512GB (High Endurance)	PFXYP6M2512
SSD 128GB (High Endurance)	PFXYP6SSD128
SSD 256GB (High Endurance)	PFXYP6SSD256
SSD 512GB (High Endurance)	PFXYP6SSD512
HDD 1TB	PFXYP6HDD1T

*1 10" Wide is available with only Standard Box, not supported for Advanced Box.

*2 PCI / PCIe is supported for only Advanced Box.

Realize secure system : Embedded allowlist Maximizes Productivity and Minimizes Risk.



Trellix



Symphony Technology Group (STG) announced on January 19, 2022 the launch of Trellix, a new business delivering extended detection and response (XDR) to organizations with a focus on accelerating technology innovation through machine learning and automation. Trellix emerges from the previously announced merger of McAfee Enterprise and FireEye in October 2021.

Box module			
	Advanced Box *1		Standard Box
CPU	Core i7	Core i5	Celeron
Core	4		2
Thread	8		4
Graphics accelerator	Intel UHD Graphics 620		Intel UHD Graphics 610
DIMM	8 - 32GB		4 - 16GB
Storage	M.2 SSD x 1 2.5" HDD / SSD x 2		M.2 SSD x 1 2.5" HDD / SSD x 1
USB	USB TypeA : USB2.0 x 2, USB3.0 x 2 USB TypeC : USB3.0 x 1 (DP connection)		
Ethernet	IEEE1588 x 2 10 / 100 / 1000 Wake-on-LAN (WOL)		
Serial	RS-232C x 1 (not isolated)		
Display Port	DP x 1		
Slot-in Option I/F	2 slots		1 slot
Expansion slots	PCI x 1 + PCIe x 1 or PCIe x 2 or PCI x 2		
Operating System	Windows10 IoT Enterprise 2019 LTSC (64bit)		
Certification *2	CE, UL and cUL, UKCA, RMC, KC, EAC, ATEX / IECEX, DNV-GL, RoHS, WEEE		

Display module						
Display Size	12"	15"	10"W *3	12"W	15"W	19"W 22"W
Resolution	XGA (1,024 x 768)		WXGA (1,280 x 800)		FWXGA (1,366 x 768)	Full HD (1,920 x 1,080)
Display Type	TFT Color LCD					
Touch Panel Type	Resistive multi-touch (2 points)		Capacitive Multi-touch (2 points) with optimized noise filter			
Touch Mode Configuration	Not applicable, because of a resistive analog touch panel		Yes-Standard mode-Glove mode,-Water detection mode			
Front USB	USB (Type A) x 1 *4		-			

*1 PCI / PCIe is supported for only Advanced Box. *2 Please check the webpage for the latest certification

*3 10" Wide is available with only Standard Box, not supported for Advanced Box. *4 By default, the USB is disabled

Dimension: PFXDM6800WC + Advanced BOX + Expansion slot + Fan

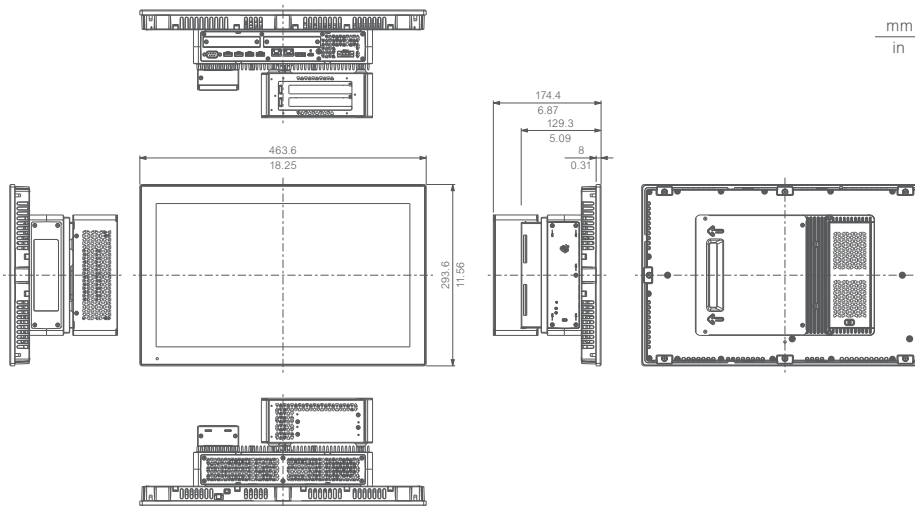

PS5000 Series



website

Combine the box type and the display in a range of sizes from 12 to the ultra-large 22 inches.

Flexibly change the functions and sizes. The box is a stand-alone component and can be connected to various displays.

Box Module		
	PS-5001B	
Model	Atom	Atom (Entry)
CPU	Atom	
Storage memory	M.2 SSD (64GB / 128GB / 256GB)	M.2 SSD (64 GB / 128 GB / 256 GB) or HDD *1 (500 GB / 1 TB) SSD *2 (256 GB)
Main Memory	4 GB, DDR3L	
Rated Input Voltage	12...24 Vdc	
OS	Win10 IoT Enterprise (64bit)	
Interface	RS-232C x 1, RS-232C / 422 / 485 x 1, Ethernet x 2, USB (Type A) x 4, Display Port x 2	RS-232C x 1, RS-232C / 422 / 485 x 1, Ethernet x 2, USB (Type A) x 2, Display Port x 1
Optional interface	None	x 1
Expansion Slot	0 slot	

*1 For secondary storage only.

Display Module						
	PS-5900W	PS-5800W	PS-5700W	PS-5600W	PS-5700T	PS-5600T
Display Size	22" Wide	19" Wide	15" Wide	12" Wide	15"	12"
Rated Input Voltage	100...240Vac / 24 Vdc					
Resolution	1,920 x 1,080pixels (Full HD)	1,366 x 768pixels (FWXGA)	1,280 x 800pixels (WXGA)	1,024 x 768pixels (XGA)		
Touch Panel Type	Capacitive (5 simultaneous touch)			Resistive Film (single touch)		
Structure	IP66					



Advanced HMI

SP5000 Series GP-Pro EX



Flagship model achieving high performance and robust network security

The SP5000 series is an HMI that provides information quickly and efficiently, and promotes "smartification" of your factories.

Flagship

01 Manage more information in various forms

Fully compatible for direct use with Windows applications, the SP5000 can handle materials, such as manuals and error codes, without conversion.



No need to bring PC for debugging and JOB reprogramming.

MS Excel

PDFs

Movies

Ladder programming tools

Able to use ladder programming tools...



02 Simple activation by inserting cards

Display data is scalable to fit multiple sizes of monitors, which can be applied to new equipment for mass production. There is no need for on-site data transfer because SP5000 models are activated when the SD card is inserted.

15"

12"

10"

Auto-scaling



SP5000 works simply by replacing the card.

This is a time-efficient way to carry out on-site troubleshooting.



03 Network segmentation

All displays of SP5000 series have two Ethernet I/F ports as standard. The IP address is changed on the SP5000 at delivery.

Only the IP LAN2 address within the office network is changed.

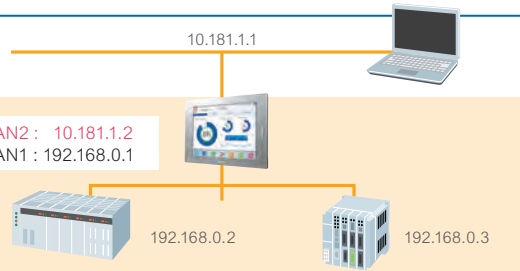

And more...

Cost Reduction and Equipment Improvement with I/O expansion

Using the option unit allows you to connect equipment that requires simple control + HMI, additional I/O expansion and remote I/O expansion.

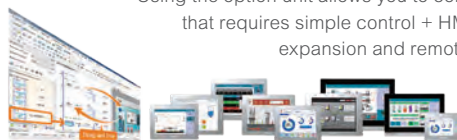

Premium Display						
	SP-5800WC	SP-5700WC	SP-5700TP	SP-5660TP	SP-5600TP	SP-5500TP
Model	PFXSP5800WCD	PFXSP5700WCD	PFXSP5700TPD	PFXSP5660TPD	PFXSP5600TPD	PFXSP5500TPD
Display Size	19" wide	15" wide	15"	12"		10"
Rated Input Voltage	12...24 Vdc					
Resolution	1,366 x 768 pixels (FWXGA)		1,024 x 768 pixels (XGA)			800 x 600 pixels (SVGA)
Display colors	16 million colors					
Touch Panel Type	Projected Capacitive (5 points multi-touch)			Resistive Film (analog, 2 points multi-touch)		
Interface	USB (Type A) x 1 USB (mini B) x 1					
Structure	IP65F, IP67F					
External Dimensions*1	W483 x H337 x D69mm (W19.02 x H13.27 x D2.72 in.)	W414 x H295 x D69mm (W16.30 x H11.61 x D2.72 in.)	W397 x H296 x D67mm (W15.6 x H11.7 x D2.64 in.)	W315 x H241 x D67mm (W12.4 x H9.49 x D2.64 in.)		W272.5 x H214.5 x D67mm (W10.73 x H8.44 x D2.64 in.)
Panel Cut Dimensions	W465 x H319mm (W18.31 x H12.56 in.)	W396 x H277mm (W15.59 x H10.91 in.)	W383.5 x H282.5mm (W15.1 x H11.12 in.)	W301.5 x H227.5mm (W11.87 x H8.96 in.)		W259 x H201mm (W10.2 x H7.91 in.)
Others	Brightness Sensor, Auto Scaling					
Custom (Coating)	-			Yes		
Custom (Front Color Bezel)	-			Yes		
Certification *2	CE, UL / cUL, UKCA, UL / cUL for Haz Loc, UKEX, RCM, KC, EAC, Marie, RoHS, WEEE					

*1 The depth is combined with Box Module *2 Please check the webpage for the latest certification

Advanced Display				
	SP-5600TA	SP-5600WA	SP-5500WA	SP-5400WA
Model	PFXSP5600TAD	PFXSP5600WAD	PFXSP5500WAD	PFXSP5400WAD
Display Size	12"	12" wide	10" wide	7" wide
Rated Input Voltage	12...24 Vdc			
Resolution	1,024 x 768 pixels (XGA)	1,280 x 800 pixels (WXGA)		800 x 480 pixels (WVGA)
Display colors	262,144 colors			
Touch Panel Type	Resistive Film (analog)			
Interface	-			
Structure	IP66F, IP67F, TYPE 4X (Indoor Use Only) / 13			
External Dimensions*1	W315 x H241 x D67 mm (W12.4 x H9.49 x D2.64 in.)	W308.5 x H230.5 x D67mm (W12.15 x H9.07 x D2.64 in.)	W268.5 x H198.5 x D67mm (W10.57 x H7.81 x D2.64 in.)	W203.6 x H148.6 x D67mm (W8.02 x H5.85 x D1.42 in.)
Panel Cut Dimensions	W301.5 x H227.5mm (W11.87 x H8.96 in.)	W295 x H217mm (W11.61 x H8.54 in.)	W255 x H185mm (W10.04 x H7.28 in.)	W190 x H135mm (W7.48 x H5.31 in.)
Others	-			
Custom (Coating)	Yes			
Custom (Front Color Bezel)	Yes			

*1 The depth is combined with Box Module

3 types of Box Modules			
	SP-5B41	SP-5B10	SP-5B00
Model	PFXSP5B41	PFXSP5B10	PFXSP5B00
Application Memory	Screen Size: 64 MB		
Backup Memory	NVRAM 320KB		
Interface	RS-232C / 422 / 485 x 2 Ethernet x 2 USB (Type A) x 3, USB (mini B) x 1 SD Card Slot (Storage) x 1 CFast Card Slot (System) x 1 CFast Card Slot (Storage) x 1 DVI-D output x 1 Sound Input: MIC or LINE input x 1 Speaker Output x 1 Alarm Output or Buzzer Output x 1	RS-232C / 422 / 485 x 2 Ethernet x 2 USB (Type A) x 2, USB (mini B) x 1 SD Card Slot (System) x 1 SD Card Slot (Storage) x 1 Speaker Output x 1 Alarm Output or Buzzer Output x 1	RS-232Cx 1 RS-422 / 485 x 1 Ethernet x 2 USB (Type A) x 2, USB (mini B) x 1 SD Card Slot (Storage) x 1
Windows Application	Yes	-	-
Expansion Unit	-	Yes	-
Connectable Devices	4		
Custom (Coating)	Yes		

Dimension: SP-5600TP + SP-5B00

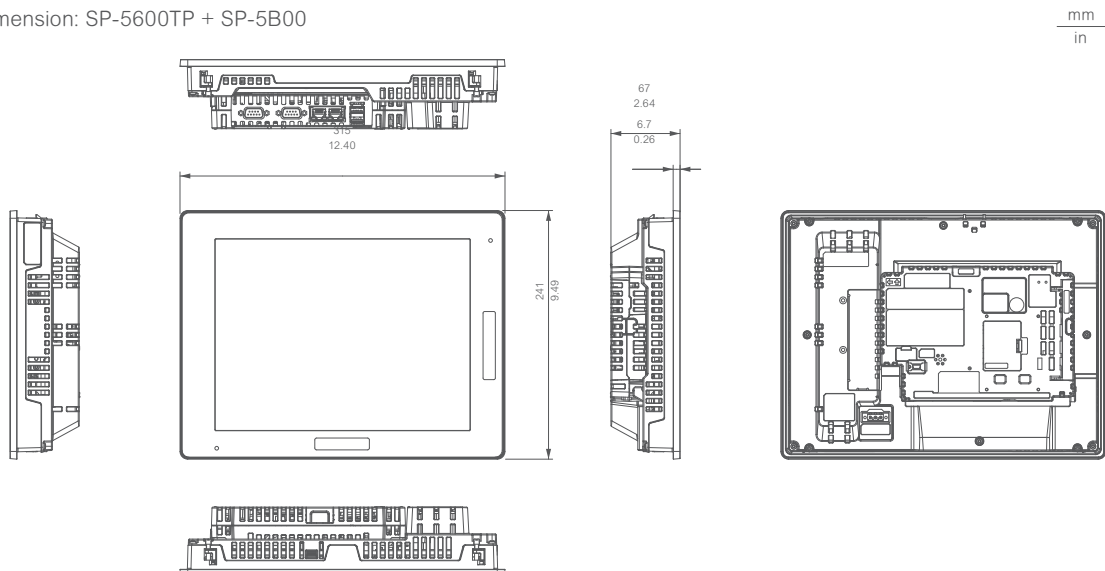



Outdoor HMI

SP5000X Series GP-Pro EX



An outdoor HMI that is visible under sunlight, and resists extreme environment

We have created a sunlight readable screen that is resistant to direct sunlight and extreme temperatures. With an enhanced information display unit and improved operability, this product is suitable for multiple applications under harsh environmental conditions including use in special purpose vehicles such as firetrucks and construction equipment; parking lots and gas stations; and the oil and gas industry.

Extreme

01 Sunlight Readable

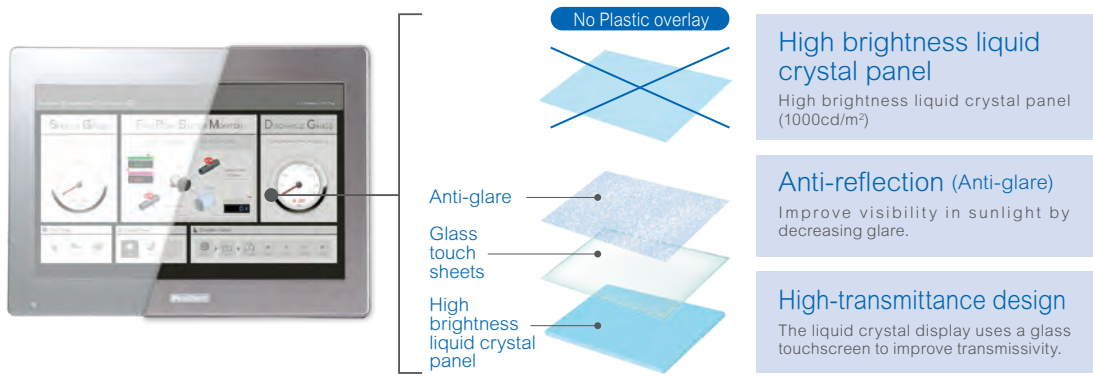

02 Robustness



UV Protection

Improve UV protection and prevent deterioration by replacing plastic components that are exposed to sunlight with metal or glass.



Full Coating

Improve the longevity of the product even when used in outdoor environments with dust and extreme temperatures by adding coating on the substrate, LCD, and power source components.

03 Environmental Resistance



Sufficient against Vibration/Shock

We do apply IEC60068-2-6 or IEC60068-2-27 in stead of IEC61131-2 test which is typically used for factory automation devices. Because they are more suitable for earth moving machines, or generators or compressors which use engines to operate machines.

* Display Module : 7" w: 2G / 40G, 15" w: 1G / 15G
Box Module : follow the connected Display Module.



Operating temperature: -30°C to 70°C

Can be used in harsher environments without the need for anti-frost heaters or fans and cooling systems.

* Display Module : 7" w: -30 to 65°C, 12" w: -30 to 70°C, 15" w: -20 to 60°C
Box Module : follow the connected Display Module.



Dust and waterproof

Compatible with IP66F, IP67F, Type 4X (indoor and outdoor use) allowing for use in harsh outdoor conditions.

04 Maintainability

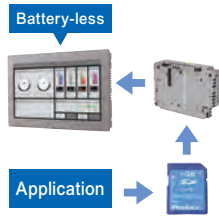

Modular structure that is easy to maintain

It is possible to replace the exposed display without changing the whole unit. The box is designed with the application pre-installed and can be used immediately upon changing components. Changes can be made quickly and easily without the need of a PC, optimizing time and resources.

05 IoT Solution



Data collection and remote maintenance

Collect data remotely from a PC such as error history and operation status, outcome, and history. It is also possible to access the HMI, verify the operation status, and conduct maintenance remotely via PC or tablet.

Display Module			
	SP-5790WA	SP-5690WA	SP-5490WA
Model	PFXSP5790WA / PFXSP5790WADF0H	PFXSP5690WA / PFXSP5690WADF0H	PFXSP5490WA / PFXSP5490WADF0H
Display type	TFT Color LCD (High brightness)		
Display size	15.6" wide	12.1" wide	7" wide
Resolution	1,366 x 768 pixels (FWXGA)	1,280 x 800 pixels (WXGA)	800 x 480 pixels (WVGA)
Display colors	262,144 colors		
Backlight	White LED (Not user replaceable. When replacement is required, contact customer support.)		
Touchpanel lifetime	1,000,000 times or more		
Rated input voltage	12...24 Vdc		
Power consumption	Max. 48 W	Max. 37 W	Max. 29 W
Ambient air temperature	-20 to 60 °C (-4 to 140 °F)	-30 to 70 °C (-22 to 158 °F)	-30 to 65 °C (-22 to 149 °F)
Dust	0.1 mg/m ³ (10 ⁻² oz/ft ³) or less (non-conductive levels)		
Pollution degree	3 for front face, 2 for other sides		
Corrosive gases	Free of corrosive gases Harsh environment model (Model numbers ending with "F0H") : IEC/EN 60721-3-3 Class 3C3		
Atmospheric pressure (operating altitude)	800 to 1,114 hPa (2,000 m [6,561 ft] or lower)		
UV resistance (front side)	Cutoff: 99% or more (380 nm)		
Vibration resistance	IEC 60068-2-6 compliant 5 to 9 Hz Single amplitude 3.5 mm (0.14 in) 9 to 150 Hz Fixed acceleration: 9.8 m/s ² X, Y, Z directions for 10 cycles (approximately 100 minutes) IEC 61373: 1999 (Category 1, Class B) 5 ≤ f ≤ 150 Hz (weight < 500 kg: f1=5 Hz, f2=150 Hz) acceleration: Up and down: 7.90 m/s ² , Right and left: 3.50 m/s ² , Back and forward: 5.50 m/s ²	IEC 60068-2-6 compliant 5 to 9 Hz Single amplitude 7 mm (0.28 in) 9 to 150 Hz Fixed acceleration: 19.6 m/s ² X, Y, Z directions for 10 cycles (approximately 100 minutes) IEC 61373: 1999 (Category 1, Class B) 5 ≤ f ≤ 150 Hz (weight < 500 kg: f1=5 Hz, f2=150 Hz) acceleration: Up and down: 7.90 m/s ² , Right and left: 3.50 m/s ² , Back and forward: 5.50 m/s ²	
Shock resistance	IEC 60068-2-27 compliant 147 m/s ² , 11 ms, X, Y, Z directions for 3 times	IEC 60068-2-27 compliant 392 m/s ² , 11 ms, X, Y, Z directions for 3 times	
Electronic fast / transient / burst immunity	IEC 61000-4-4 / 2 kV: Power port / 1 kV: Signal ports		
Electrostatic discharge immunity	Contact discharge method: 6 kV Air discharge method: 8 kV (IEC/EN 61000-4-2 Level 3)		
Structure	IP66F, IP67F, Type 4X (indoor and outdoor use), Type 12, Type13		
External dimensions	408 x 264 x 68 mm (16.06 x 10.39 x 2.68 in)	308.5 x 230.5 x 68 mm (12.15 x 9.07 x 2.68 in)	203.6 x 148.6 x 37 mm (8.02 x 5.85 x 1.45 in)
Front bezel materials	Aluminum die-cast / Stainless steel		
Certification	CE, UL/cUL, UKCA, UL/cUL for Haz Loc, UKEX, RCM, KC, EAC, IECEx / ATEX, RoHS, WEEE		

Box Module	
Model	SP-5B90
Application Memory	Screen Size: 64 MB
Backup Memory	NVRAM 320KB
Interface	RS-232C / 422 / 485 x 2, Ethernet x 2, USB (Type A) x 2, USB (mini B) x 1, SD Card Slot (System) x 1, SD Card Slot (Storage) x 1, Speaker Output x 1, Alarm Output or Buzzer Output x 1
Expansion unit	Fieldbus Unit x 1 (PROFIBUS / J1939 / CANopen / FLEX NETWORK)
Connectable Devices	4

Dimension: SP-5690WA + SP-5B90

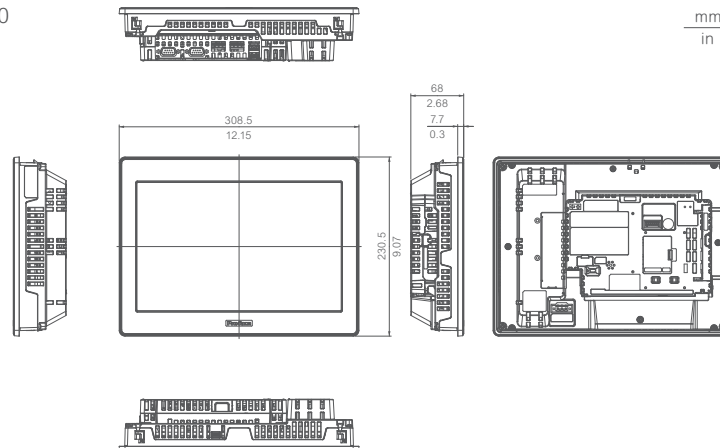



website



video



manual



datasheet



CAD



software (BLUE)



software (GP-Pro EX)

Basic HMI

ST6000 Series

BLUE **GP-Pro EX**



Achieve a high level of visualization with the new basic HMI

The ST6000 series brings a new level of visualization to the Basic HMI market which no other basic product has accomplished.

New Visualization

01 Refined

An innovative HMI with a sophisticated design that transforms simple machines.



16 Million Colors

Achieve the previously unimaginable and bring displays to life with 16 million colors.



Better Graphics and Font

Display beautiful fonts with anti-aliasing. Customize gradation and transparency to meet your needs.

02 Simple & Easy

The simple design and interface help increase productivity and efficiency.



Design



Installation



Maintenance



Operation

Easy Migration **GP-Pro EX**

Panel cut-out compatibility

Utilize the current project data because of the same software(GP-Pro EX)

Minimum modification to install new HMI (Compatible Interface) same interface and almost the same interface location



03 Connected & Secured

Seamless and secured connectivity with various devices to enhance their flexibility and increase value.

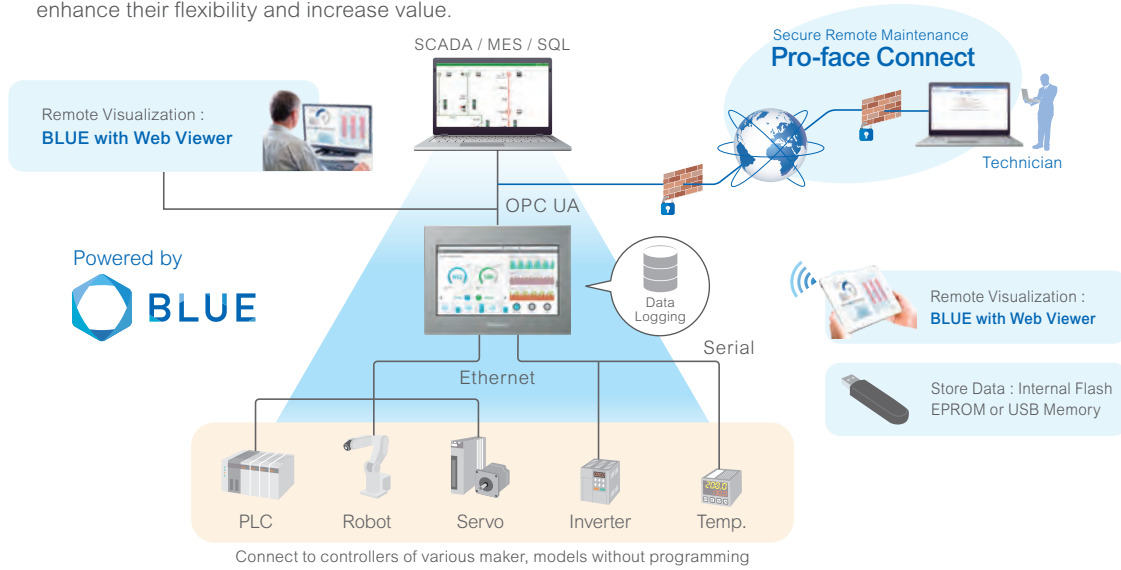

	ST-6700WA	ST-6600WA	ST-6500WA	ST-6400WA	ST-6200WA
Model No (BLUE)	PFXST6700WAD	PFXST6600WAD	PFXST6500WAD	PFXST6400WAD	PFXST6200WAD
Model No (GP-Pro EX)	PFXST6700WADE	PFXST6600WADE	PFXST6500WADE	PFXST6400WADE	PFXST6200WADE
Display	15.6" Wide (1,366 x 768)	12.1" Wide (1,280 x 800)	10.1" Wide (1,024 x 600)	7.0" Wide (800 x 480)	4.3" Wide (480 x 272)
Touch Panel	16M colors				
	Type : Resistive film (analog), Service life : 1,000,000 times or more				
Interface	COM	RS-232C x 1, RS-422 / 485 x 1			RS-232C / 422 / 485 x 1
	Ethernet	Ethernet x 2			Ethernet x 1
	USB	Type A x 1 micro-B x 1			Type A x 1 micro-B x 1
Memory (BLUE)	Application memory : FLASH EPROM:128MB Backup memory : NVRAM 500KB Battery : Replaceable battery / Primary battery for clock data backup (5 years or more at room temperature)				
Memory (GP-Pro EX)	Application memory : Media : FLASH EPROM / Screen area: 64MB / User font area 8 MB / Logic program area: 132KB Backup memory : Screen Area: SRAM 320KB, Variable Area: SRAM 64KB Battery : Replaceable battery / Primary battery for clock data backup				
Input voltage	24 Vdc				
Structure	IP65F, Type 1, Type 4X (indoor use only), Type 13				
Certifications *1	CE, UL and cUL, UKCA, RCM, KC, EAC, RoHS, WEEE				

	ST-6300T	ST-6500T
Model No	PFXST6300TADE	PFXST6500TADE
Display	5.7"	10.4"
	262,144 colors	16M colors
Resolution	480 x 272	800 x 600
Touch Panel	Type: Resistive film (analog), Serve life: 1,000,000 time or more	
Interface	COM	RS-232 x 1, RS-422/485 x 1
	Ethernet	10BASE-T / 100BASE-TX x 1
	USB	Type A x 1, micro-B x 1
	SD	- up to 32 GB
Memory	Application memory : FLASH EPROM:64MB, Backup memory : Screen Area: MRAM 320KB, Variable Area: MRAM 64KB Battery : Replaceable battery / Primary battery for clock data backup (5 years or more at room temperature)	
Input voltage	301.5 x 227.5 mm(11.87 x 8.96 in)	156 x 123.5 mm(6.14 x 4.86 in)
Panel Cut Dimensions	19.2 to 28.8V DC	
Certifications *1	IP65F, Type 1, Type 4X (indoor use only), Type 13 (on the front panel when properly installed in an enclosure), CE, UL and cUL, UKCA, RMC, KC, EAC, RoHS, WEEE	
Structure	IP65F, Type 1, Type 4X (indoor use only), Type 13	

*1 Please check the webpage for the latest certification

Dimension : ST-6400WA

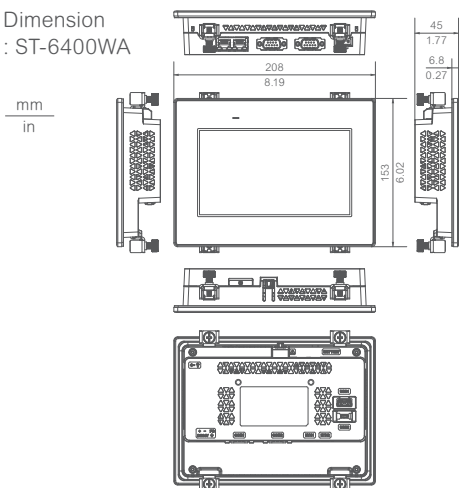

ST6000 Customer Story



Food and Beverage - Goodlife

Good Life Technologies Pvt. Ltd. was founded in 2007 and manufactures bakery machines. We have two manufacturing plants and further expanding the business. By Pro-face solution, Good Life Technologies has been able to provide remote service and maintain machines remotely. This has led to significant time and cost savings when dispatching service staff.



website



video



manual



datasheet



CAD



software

Basic Modular HMI

STM6000 Series BLUE GP-Pro EX

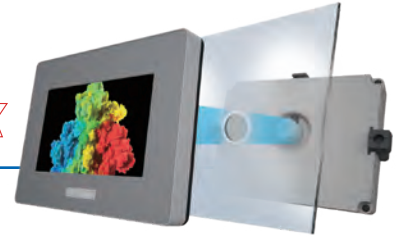

The STM6000 series in the complement of the ST6000 range brings a new level of visualization to the Basic HMI market which no other basic product has accomplished. Also, the product can be installed easily as no tools are necessary and very fast with the unique push-button mounting system through a $\phi 22$ mm circular hole.

01 Easy & Fast Installation

The product can be installed easily as no tools are necessary and very fast with the unique push-button mounting system through a $\phi 22$ mm circular hole.

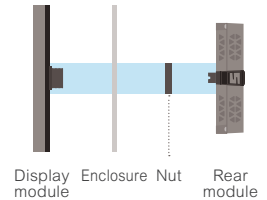

02 Flexible Installation

Thanks to modularity design, for specific applications (space, temperature, or vibration constraints) product can be separated with cable accessory 3m, 5m,10m to install the Display module on the panel door and the rear module on DIN rail with dock station adapter.

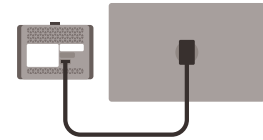

03 Easy Maintenance

Spare part front & rear modules are available to replace the faulty part.

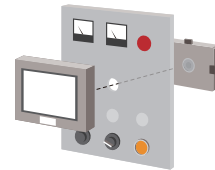

	STM-6400WA	STM-6200WA
Model No(BLUE)	PFXSTM6400WAD	PFXSTM6200WAD
Model No(GP-Pro EX)	PFXSTM6400WADE	PFXSTM6200WADE
Display	7.0" Wide (800 x 480)	4.3" Wide (480 x 272)
Touch Panel	16M colors White LED 16 level brightness control	
Interface	Type: Resistive film (analog) , Serve life: 1,000,000 time or more	
Memory	RS-232C / 485 / 422 x 1 Ethernet x 2 USB (Type A) x 1 USB (micro-B) x 1	
Input voltage	Application memory : FLASH EPROM:128MB, Backup memory : NVRAM 500KB Battery : internal battery / Primary battery for clock data backup (5 years or more at room temperature)	
Structure	19.2 to 28.8V DC	
Certifications *1	IP65F , UL 50/50E , Type 1 , Type 4X (indoor use only), Type 12, Type 13, CE, UL/cUL, RCM, KC, EAC, ATEX/IECEX*1, Marine (ABS, RINA), RoHS, WEEE	

*1 Please check the webpage for the latest certification

Dimension: STM-6400WA

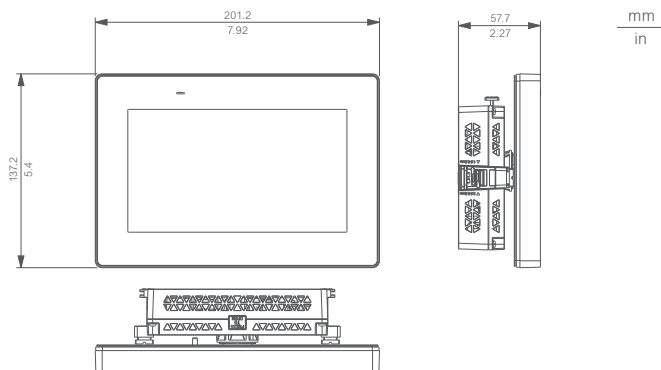

STW6000 Series

Many industrial automation devices support HTML5, which can be displayed on PCs, tablets, and smartphones. As a Web HMI, STW6000 can easily display HTML5 data from multiple devices. We are the HMI specialist, and the superior quality display, maintainability and robustness of our Web HMI meets the needs of simple machine applications for factory automation.

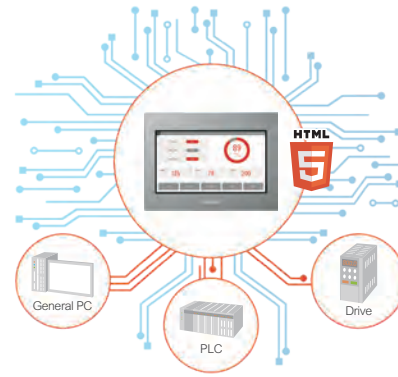

01 Main Display

Main display for simple machine is alternative to basic terminal.

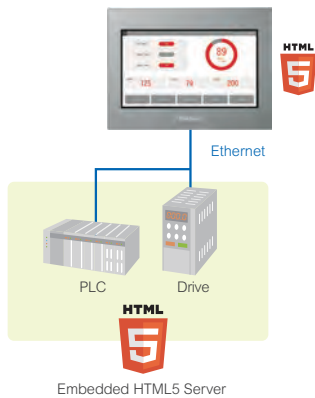

02 Secondary Display

Secondary cost effective display can also visualize small information for maintenance-diagnostic directly from PLC Servers or from the main display if it embeds its own server.

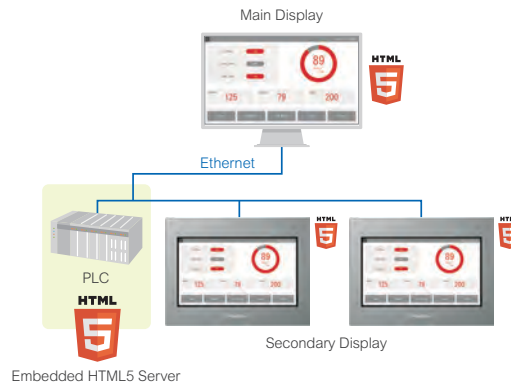

	STW-6700WA	STW-6600WA	STW-6500WA	STW-6400WA	STW-6200WA
Model No	PFXSTW6700WAD	PFXSTW6600WAD	PFXSTW6500WAD	PFXSTW6400WAD	PFXSTW6200WAD
Display	15.6" Wide (1,366 x 768)	12.1" Wide (1,280 x 800)	10.1" Wide (1,024 x 600)	7.0" Wide (800 x 480)	4.3" Wide (480 x 272)
Touch Panel	16M colors White LED 16 level brightness control Type:Resistive film (analog), Service life:1,000,000 times or more				
Related	Ethernet1 & Ethernet2 with switch function : IEEE802.3i / IEEE802.3u, 10BASE-T / 100BASE-TX USB : Type A x 1 (HOST)				Ethernet : IEEE802.3i / IEEE802.3u, 10BASE-T / 100BASE-TX x 1 USB : Type A x 1 (HOST)
Input voltage	24 Vdc				
Structure	IP65F, Type 1, Type 4X (indoor use only), Type 13				
Certifications *1	CE, UL and cUL, UKCA, RCM, KC, EAC, RoHS, WEEE				

*1 Please check the webpage for the latest certification

Dimension: STW-6400WA

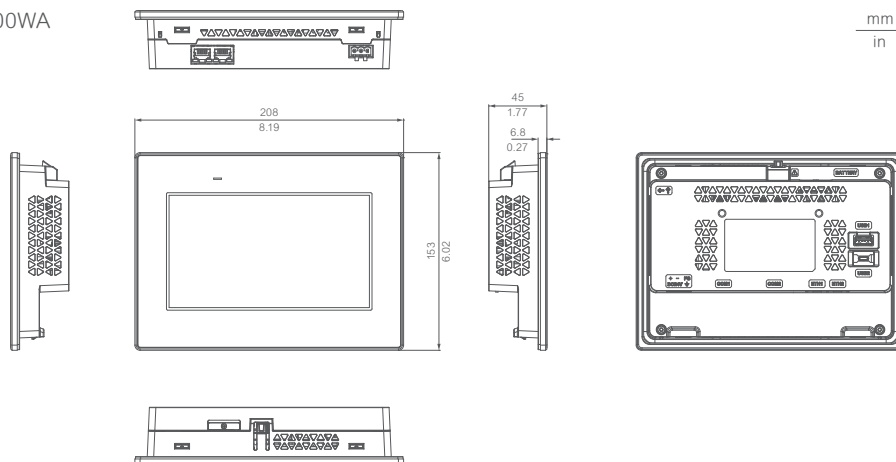



website



manual



datasheet



CAD



software

Standard HMI

GP4000 Series *GP-Pro EX*



Standard

Varied and flexible lineup satisfying customers needs

Combines abundant functions with a broad line-up of versatile models to meet the specific needs of every customer.

01 Widest line-up in the Pro-face brand

From classic to unique, we offer a wide range of choices to meet any application.



02 Compatible with our legacy models



Data in GP-PRO/PBIII for Windows or later is convertible using project converter. Smooth transition to the latest models.



USB expansion options unique to Pro-face

Reduce excess inventory of indicator lights

EZ Tower Light Model : PFXZCETWHA1 (tube mounting with fixing plate)
Model : PFXZCETWW1 (base mounting)

With this single model, multiple colors and sounds can be set. Capable of indicating the state of equipment.

- LED lamps adaptable to various types of setting
- Configuration from HMI
- 4 colors (red, green, blue, and yellow) and 3 modes (off, on, and blink)
- Number of lamps: 3
- Buzzer patterns: 4



Combining switch and lamp

EZ Illumination Switch Model : PFXZCCEUSG1

Improve visibility with 6-color illumination. Reduce man-hours for control panel installation and wiring

- LED light switches accept a wide range of settings
- Configuration by HMI design software
- 6 colors (red, green, blue, yellow, white, and orange) and 3 modes (off, on, and blink)
- Protection structure: IP65 (front face where panel is embedded)
- Mount: 22φ circular mounting hole



Work-saving for inputting repeated values

EZ Numpad Model : PFXZCCEUKB1

Reduces screens needed for value input

- Alphanumeric and customizable function keys (Set by HMI design software)
- Protection: IP65
- Mount: 22φ circular mounting hole



Adding second LAN port with independent IP address

EZ LAN Adapter Model : PFXZCGEUEE1

The GP4000 series also allows you to securely set up a network.

- Same functions as built-in LAN port
- 10BASE-T / 100BASE-TX
- Limited to GP4000 standard models



Also can be used with Pro-face products other than GP4000 series.



Standard models								
	GP-4601T	GP-4603T	GP-4501T	GP-4503T	GP-4401T	GP-4301T	GP-4303T	GP-4201T
Model	PFXGP4601T**	PFXGP4603TAD	PFXGP4501T**	PFXGP4503TAD	PFXGP4401TAD	PFXGP4301TAD	PFXGP4303TAD(isolation model)	PFXGP4201TAD
Display Size	12.1"		10.4"		7.5"	5.7"		3.5"
Rated Input Voltage	100...240 Vac / 24Vdc		100...240 Vac / 24Vdc		24Vdc			
Resolution	800 x 600pixels (SVGA)		640 x 480pixels (VGA)			320 x 240pixels (QVGA)		
Display colors	65,536 colors (No blink) / 16,384 colors (Blink)							
Touch Panel Type	Resistive Film (analog)							
Application Memory	32MB				16MB			
Data Backup	SRAM 320KB							
Interface	RS-232C x 1,RS-422 / 485 x 1*,Ethernet x 1 USB (Type A) x 1,USB (mini B) x 1,SD Card Slot x 1							RS-232C / 422 / 485 x 1, Ethernet x 1,USB (Type A) x 1, USB (mini B) x 1,
Structure	IP65F							
External Dimensions	W315 x H241 x D56mm (W12.4 x H9.49 x D2.2 in.)		W272.5 x H214.5 x D57mm (W10.73 x H8.44 x D2.24 in.)		W218 x H173 x D60mm (W8.59 x H6.81 x D2.37 in.)	W169.5 x H137 x D59.5mm (W6.67 x H5.39 x D2.34 in.)		W132 x H106 x D42mm (W5.2 x H4.17 x D1.65 in.)
Panel Cut Dimensions	W301.5 x H227.5mm (W11.87 x H8.96 in.)		W259 x H201mm (W10.2 x H7.91 in.)		W204.5 x H159.5mm (W8.05 x H6.28 in.)	W156 x H123.5mm (W6.14 x H4.86 in.)		W118.5 x H92.5mm (W4.67 x H3.64 in.)
Connectable Devices	4							
Custom (Coating)	Yes							
Custom (Front Color Bezel)	Yes							
Rear Mount model (GP4000R)	Model:PFXGP4601TADR		Model:PFXGP4501TADR		Model:PFXGP4401TADR	Model:PFXGP4301TADR		-
External Video Unit-supporting Model	Product Name:GP-4621T Model:PFXGP4621TAA Model:PFXGP4621TAD (coating:Yes)		Product Name:GP-4521T Model:PFXGP4521TAA Model:PFXGP4521TAD (coating:Yes)		<div style="border: 1px solid black; padding: 5px;"> Best choice for replacement! VM or RGB unit from GP3000 can be used without additional settings. </div> 			

** : [AA] Analog touchscreen & AC power supply; [MD] Matrix touchscreen & DC power supply; [AD] Analog touchscreen & DC power supply; [MA], Matrix touchscreen & DC power supply.
 * : GP-4*03T:RS-485 (isolation)

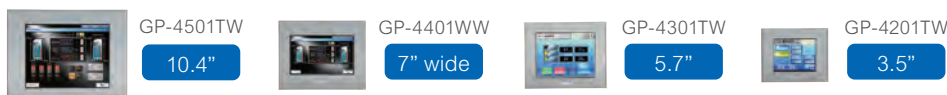

W models				
	GP-4501TW	GP-4401WW	GP-4301TW	GP-4201TW
Model	PFXGP4501TADW	PFXGP4401WADW	PFXGP4301TADW	PFXGP4201TADW
Display Size	10.4"	7"wide	5.7"	3.5"
Rated Input Voltage	24Vdc			
Resolution	640 x 480pixels (VGA)	800 x 480pixels (WVGA)	320 x 240pixels (QVGA)	
Display colors	65,536 colors (No blink) / 16,384 colors (Blink)			
Touch Panel Type	Resistive Film (analog)			
Application Memory	16MB		8MB	
Data Backup	SRAM 128KB			
Interface	RS-232C x 1,RS-422 / 485 x 1,Ethernet x 1, USB (Type A) x 1,USB (mini B) x 1,SD Card Slot x 1,		RS-232C x 1,RS-422 / 485 x 1 Ethernet x 1*, USB (Type A) x 1,USB (mini B) x 1,	
Structure	IP65F			
External Dimensions	W315 x H241 x D56mm (W12.4 x H9.47 x D2.20 in.)	W218 x H173 x D60mm (W8.59 x H6.8 x D2.37 in.)	W169.5 x H137 x D59.5mm (W6.67 x H5.39 x D2.34 in.)	W132 x H106 x D42mm (W5.2 x H4.17 x D1.05 in.)
Panel Cut Dimensions	W301.5 x H227.5mm (W11.87 x H8.96 in.)	W204.5 x H159.5mm (W8.05 x H6.28 in.)	W156 x H123.5mm (W6.14 x H4.86 in.)	W118.5 x H92.5mm (W4.67 x H3.64 in.)
Connectable Devices	2			
Custom (Coating)	Yes			
Custom (Front Color Bezel)	Yes			

*:Excluding GP-4201W

GP4000R Rear mount model

Optimized for hygiene-oriented environments.

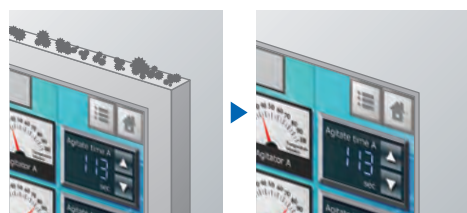

Flat design to protect from mounting surface from dust.
 Ideal for medical or food production equipment.

GP4100 Compact model

GP-Pro EX

4.3"



High resolution and full color in a small size

01 Small-sized HMI but no compromises visibility or operability

With a resolution of 480 x 272 pixels, information is finely displayed despite the limitations of space.

And more... **65,536** color display

Panel cut same as monochrome model



Monochrome model (GP-410**)



Panel cut adapter (Model: PFXZCFAD31)

02 Connectivity with a range of devices

This product allows you to collect data and monitor everything remotely using a tablet.

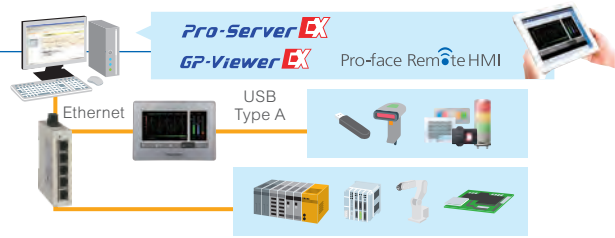

	GP-4114T	GP-4115T	GP-4115T3	GP-4116T
Model	PFXGP4114T2D	PFXGP4115T2D	PFXGP4115T3D	PFXGP4116T2D
Display Size	4.3"			
Rated Input Voltage	12...24 Vdc			
Resolution	480 x 272 pixels			
Display colors	65,536 colors			
Touch Panel Type	Analog			
Application Memory	8MB			
Backup Memory	FLASH EPROM 128KB		NVRAM 320KB	FLASH EPROM 128KB
Interface	Ethernet x 1 USB (Type A) x 1, USB (mini B) x 1	RS-232C x 1 USB (Type A) x 1, USB (mini B) x 1		RS-422/485 x 1 USB (Type A) x 1, USB (mini B) x 1
Structure	IP65F			
External Dimensions	W124.9 x H90.4 x D38.8mm (W4.92 x H3.56 x D1.53 in.)			
Panel Cut Dimensions	W112.5 x H77.5mm (W4.43 x H3.05 in.) With Panel cut adapter: W105 x H66mm (W4.13 x H2.6 in.)			
Connectable Devices	2			

GP4000H Handy model

GP-Pro EX

GP-4311HT

5.7"



The latest handy display with high compatibility with the GP3000H models and reduced weight.

	GP-4311HT
Model	PFXGP4311HTAD
Display Size	5.7"
Rated Input Voltage	24Vdc
Resolution	640x480 pixels (VGA)
Display colors	65,536 colors
Touch Panel Type	Analog
Application Memory	32MB
Structure	IP65F
Connectable Devices	3
Interface	RS-232C / 422 / 485 x 1, Ethernet x 1, USB (Type A) x 1, USB (mini B) x 1, SD Card Slot x 1 Function Switch x 12, Switches: 1a2b 3-Position Enable Switch Output: 2a Key Switch Output: 1c <When using the conversion adapter> Operation Output x 1 External Buzzer Output x 1

Hard-type Direct-connect Cable	10m	GP3000H-CBLH-10M
	3m	GP3000H-CBLS-3M
Soft-type Direct-connect Cable	5m	GP3000H-CBLS-5M
	10m	GP3000H-CBLS-10M
Hard-type Direct-connect Cable (with connector)	10m	GP3000H-CBLHD-10M
	3m	GP3000H-CBLSD-3M
Soft-type Direct-connect Cable (with connector)	5m	GP3000H-CBLSD-5M
	10m	GP3000H-CBLSD-10M
Conversion Adapter	AGP3000H-ADPCOM-01	

LT4000M Series *GP-ProEX*

Hybrid display with control function

5.7" 3.5"

Since the release of the world's first controller with display (CGP model) in 1996, our products have gained a reputation for enabling customers to save space as well as equipment costs.



Flexible

- website
- video
- manual
- datasheet
- CAD
- software

01 Simple design without PLC

Connectivity with a range of devices.

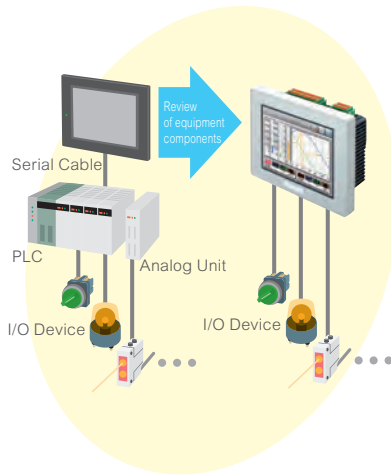

02 Easy to create control panels

Easily retrofittable, requiring only 22φ circular mounting holes

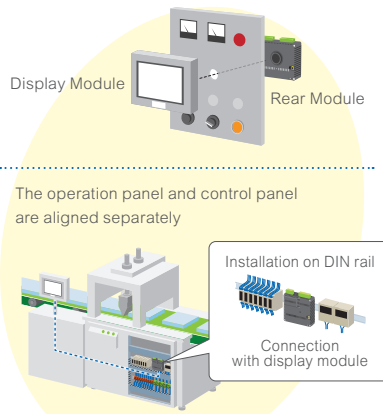

Product Name	Length	Model
Display module	3m	PFXZXMADSM31
Rear module separation cable	5m	PFXZXMADSM51

03 Create systems with reduced wiring using remote I/O.

Compatible with European standard CANopen. Communicate with CANopen compatible slave units with LT as master



	LT-4301TM		LT-4201TM	
	PFXLM4301TADD*	PFXLM4301TADA*	PFXLM4201TADD*	PFXLM4201TADA*
Model	PFXLM4301TADD*	PFXLM4301TADA*	PFXLM4201TADD*	PFXLM4201TADA*
Display Size	5.7"		3.5"	
Rated Input Voltage	24Vdc			
Control	DIO	AIO+DIO	DIO	AIO+DIO
Resolution	320 x 240pixels (QVGA)			
Touch Panel Type	Resistive Film (analog)			
Application Memory	16MB			
Backup Memory	NVRAM 128KB			
Logic program area	FLASH EPROM 132KB			
Variable area	NVRAM 64KB			
Interface	RS-232C / 485 x 1 Ethernet x 1 USB (Type A) x 1 USB (mini B) x 1 CANopen (Master) x 1			
Structure	IP65F			
External Dimensions	Display Module:W163 x H129.4 x D17.5mm (W6.42 x H5.09 x D0.69 in.) Rear Module:W128 x H108 x D60.15mm (W5.03 x H4.25 x D2.36 in.)		Display Module:W97.6 x H80 x D16.2mm (W3.8 x H3.1 x D0.63 in.) Rear Module:W128 x H108 x D60.15mm (W5.03 x H4.25 x D2.36 in.)	
Panel Cut Dimensions	φ22.5mm			
Connectable Devices	4			
Built-in DIO (Input)	20 points (configurable 2 x High Speed counter / Pulse catch or 1 Up / Down High Speed Counter)	12 points (configurable 2 x High Speed counter / Pulse catch or 1 Up / Down High Speed Counter)	20 points (configurable 2 x High Speed counter / Pulse catch or 1 Up / Down High Speed Counter)	12 points (configurable 2 x High Speed counter / Pulse catch or 1 Up / Down High Speed Counter)
Built-in DIO (Output)	12 points (configurable 2 x PWM / Pulse)	8 points (configurable 2 x PWM / Pulse)	12 points (configurable 2 x PWM / Pulse)	8 points (configurable 2 x PWM / Pulse)
Built-in AIO (Input)	0 points	4 points (Voltage / Current x 2 - Temperature input x 2 included)	0 points	4 points (Voltage / Current x 2 - Temperature input x 2 included)
Built-in AIO (Output)	0 points	2 points (Voltage / Current x 2)	0 points	2 points (Voltage / Current x 2)

Pro-face Edge Box



Step Towards Smart Manufacturing

Pro-face Edge Box has industry-leading connectivity that enables collecting and utilizing data from various devices in various locations. Depending on your needs, you can choose the best-in-class data-collecting device from our wide range of lineups. Just add the Pro-face Edge Box; no need to change the current design. Let's start Smart Manufacturing with Pro-face Edge Box right now.

Edge Box PC

Application Integration

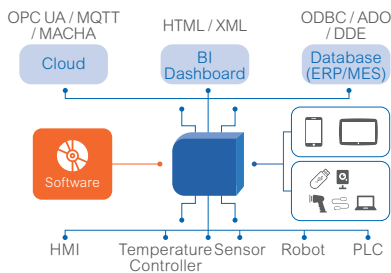

Production Monitor

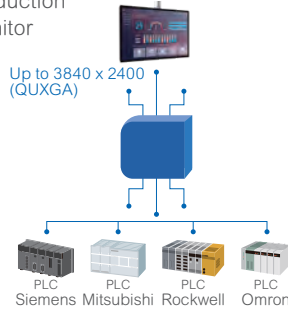

STM6000 Edge Box HMI

Get ready for Cloud service

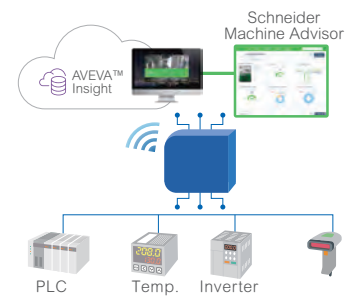

STM6000 Gateway Box

Data Generator

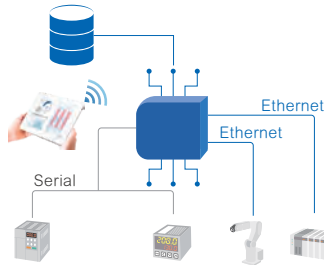

On-demand HMI



Secure Access Point

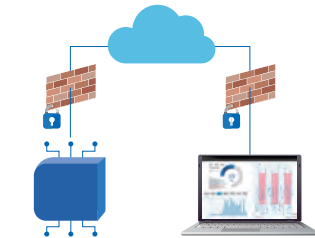

	Model No	Description	Software	Data management / Scheduler / Trend	OT Protocols	IT Protocols
Edge Box PC	PFXPL2BxxxxNxxx00	Box IPC (No pre-installed software) Windows	BLUE Open Studio V8.1 or later	Math task / Event logger / with database	158 available communication drivers	HTTPs, OPC-UA, MQTT, HTML, XML, ODBC, ADO, DDE, MACHA
	PFXPL2Bxxxx4xxx00				11 available communication drivers	
STM6000 Edge Box HMI	PFXSTM6B00DIOT	Edge Box HMI + Din Rail accessory, HMI Runtime 500 tags, One connection Mobile Access	BLUE Open Studio 2020 SP2 or later	-	76 available communication drivers	OPC-UA (Sever)
STM6000 Gateway Box	PFXSTM6B00D	Basic Gateway HMI Runtime Web Viewer License	BLUE 3.2 or later	-	76 available communication drivers	OPC-UA (Sever)

Multi-Converter

	SP5000 (Open BOX) Model	SP5000 (Power BOX) Model	SP5000 (Standard BOX) Model	LT4000M Model	STM6000 Model
Base module	PFXSP5B41	PFXSP5B10	PFXSP5B00	PFXLM4B01DAC	PFXSTM6B00D
				PFXLM4B01DAK	
				PFXLM4B01DDC	
				PFXLM4B01DDK	
Adapter	PFXZCDAEXP1			PFXZXMADSA1	
Software	GP-Pro EX				BLUE

FANUC limited model(Model:PFXLM4B01DAKFF) is available. Data collection from CNC of old machines.

Flat Panel Monitors

Improve your machine's operativity

Pro-face Flat Panel Monitors are industrial PC monitors with a touch panel mounted and offered solutions for difficult installation due to a harsh production-work site environment or limitation of space.



Fits the most suitable place for machine operation by installing separately.



BOX PC

Industrial Flat Panel Monitors

Improve operation efficiency with a secondary display.



Panel PC

Industrial Flat Panel Monitors

Distance to connect (5m)

Host	Cable	Display Size	Display
PS6000 Series PS5000 Series (Only Windows 10) Windows OS-installed PC (Only Windows 10)	DVI (video), USB (touch)	22" Wide	FP-6900WC
		19" Wide	FP-6800WC
		15" Wide	FP-6700WC
		12" Wide	FP-6600WC
		10" Wide	FP-6500WC
		15"	FP-6700TM
		12"	FP-6600TM

Distance to connect (100m)

Host	Cable	Display Size	Display	Supported Touch Control	Expansion Adapter
PS5000 Series	Ethernet (video, touch)	22" Wide	PS-D5900WP	Max 4 Displays	 Display Adapter
		19" Wide	PS-D5800WP		
		15" Wide	PS-D5700WP		
		12" Wide	PS-D5600WP		
		15"	PS-D5700TA		
PS5000 Series (except PS-5700T / 5600T) SP5000 Series SP-5B41 Windows OS-installed PC		12"	PS-D5600TA	Max 3 Displays	 Multi Display Adapter
		19" Wide	SP-5800WC		
		15" Wide	SP-5700WC		
		15"	SP-5700TP		
		12"	SP-5600TP		
	10"	SP-5500TP			
	12"	SP-5600TA			
	12" Wide	SP-5600WA			
10" Wide	SP-5500WA				
		7" Wide	SP-5400WA		



BLUE Line Management Lite SCADA Open Studio

VERSION UP

FDA
21 CFR PART 11



Flexible software for your need

Pro-face BLUE Open Studio is a development and runtime software that incorporates various tools users need to create SCADA HMI applications, dashboards and OEE interfaces.

Basic Features

- Scripting
- Security
- Symbols
- Tags Database
- Troubleshooting
- Gestures
- Alarms
- Animation
- Database
- Events
- Graphics and Design Tools
- Trends
- Multi-Language
- ActiveX and .NET
- Recipes
- Multi-touch
- Reports
- Scalable
- Scheduler
- OPC
- Intellectual Property Protection
- Email (SMTP)
- FTP
- Historical Performance
- PDF Export
- SSL Support for Emails
- DDE Client
- Custom Widgets

Connectivity

250+ available communication drivers for PLCs and many other devices.
Native OPC interfaces such as OPC UA/DA
Active X and .Net controls
Support upper connectivity to DB through MQTT.

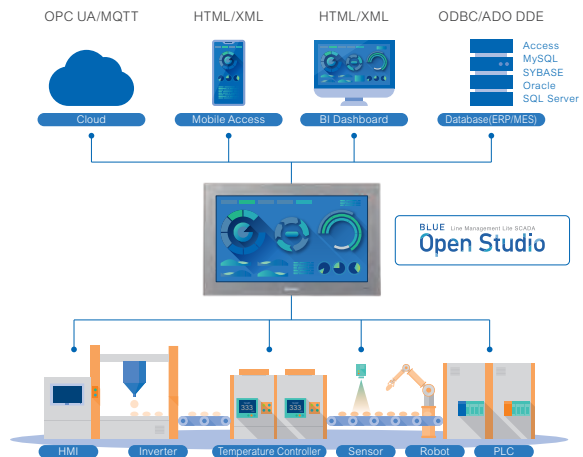

Database

Connect to any SQL database (Microsoft SQL, MySQL, Sybase, Oracle), or Microsoft Access or Excel, and ERP/MES systems (including SAP), even from Windows Embedded Compact Edition. BLUE Open Studio is flexible, offering a built in interface that doesn't require knowledge of SQL for trends, alarms/events, grid and other objects).

OPC

BLUE Open Studio provides native OPC interfaces, such as OPC DA (Server/Client), OPC HDA(Server), UA (Server/Client) and OPC .NET 3.0 (Client). BLUE Open Studio also supports OPC XML.

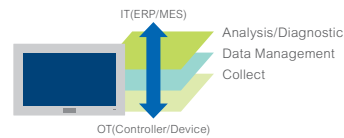

Trends

Real-time and Historical trends, and SPC functionality are supported. Log data in binary format, or to any local or remote SQL database. Color or fill trends with graphic elements to enhance clarity of data. Date/ Time based or numeric (X/Y plot) trends give you the flexibility to display information that best suits your application.

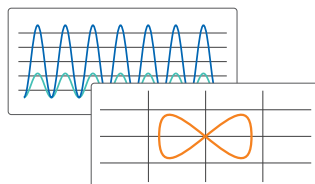

Custom Widget

Custom Widgets provides the ability to integrate third-party web-based controls into the HMI/SCADA project screens. Develop and share a library of controls that can be easily integrated into an application and accessible through multiple platforms.

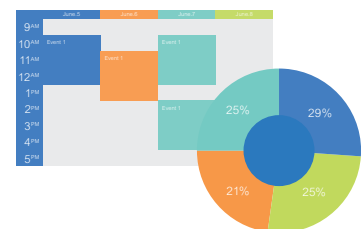

Historian

BLUE Open Studio includes support for saving historical data from some task worksheets to a Historian database or AVEVA Insight.

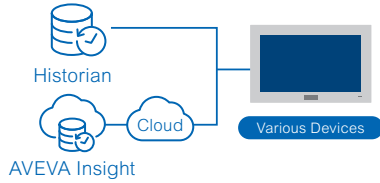

Import Wizard

PanelMate (Eaton and Cutler Hammer)
FactoryTalk View ME/SE (Rockwell)
PanelBuilder32SESSE (Rockwell)

Automatically
converting

BLUE Line Management Lite SCADA
Open Studio



Remote Access

Access your BLUE Open Studio Screen from any device with a browser that supports HTML5, such as iPads, iPhones, Android devices, Windows devices, and others.



License Lineup

To version-up from Version 8.0 / 8.1 to 2020, version-up licenses are required. In addition, upgrade licenses are available to upgrade (ex, from Line management plus to Supervision)

Product Name	No.of Licenses	No.of Tags	Model
BLUE Open Studio for Supervision	1 License	64,000	PFXBOS*T64K*A
BLUE Open Studio for Line Management Plus	1 License	32,000	PFXBOS*T32K*A
BLUE Open Studio for Line Management	1 License	4,000	PFXBOS*T4K*A
BLUE Open Studio for Machine Control	1 License	1,500	PFXBOS*T1K*A
BLUE Open Studio Basic	1 License	-	PFXBOS*T500*A
BLUE Open Studio Thin Client	1 License	-	PFXBOSTC
BLUE Open Studio Import Wizard	-	-	PFXBOSTK
BLUE Open Studio USB Hard key	-	-	PFXBOSUSBL

PS6000 + BLUE Open Studio



Hardware and software association to improve your business

1

Full support & Integration on HW, SW and OS

Our dedicated support team ensures that you have a single contact window to resolve any issues

Integration is easy across our hardware, software and operating systems so commissioning is completed even faster

Save Time

2

Save time & resources on validation and commissioning

PS6000 Series and BLUE Open Studio configured-to-order association is ready to use after our extensive testing and validation process, so you can save time, money and resources and have your application up and running

3

Sustainable supply & compatibility

Enjoy one supplier for your software and hardware requirements

Stress free replacement with ongoing development to meet industry requirements

Save Money





website



video



manual



software



What's new



Versatile Software

Revolutionary new software, BLUE offers an alternative experience in HMI project design. Anyone can easily create and change dynamic screens.

Refined

High quality graphics

Clearer fonts and screen parts make an obvious difference. The clarity is not affected by zoom level



Stylish design

Customize gradation and transparency to meet your needs. Stylish expression including transparent effects.

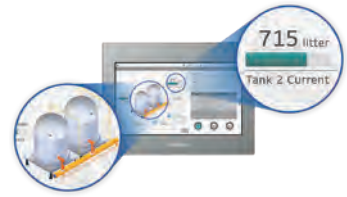

Simple & Easy

One source, multiple ways to present

Support HMI project designer to adapt/customize projects and create easily situational awareness projects delivering more intuitive projects to the operators.



View all needed information at once

Simply display all necessary screens in one place. Multi-screen information gives rise to improvement in operation efficiency.



Responsive Behavior (Dock panel)

Several pages in one screen, and independent navigation in each section. Adapt the size of information to meet your needs with one click on the dynamic display.



Highly flexible graph features

Using data analyzing features, such as graph comparison, can produce more expressive insight than ever before



Change the value of a variable without programming

Use a converter to change the value of a variable from the defined unit, range, scale, and expression without programming.

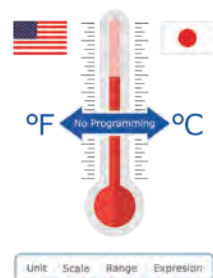

Create nice-looking HMI applications easily (HMI Design Studio)

HMI Design Studio is a creative yet easy-to-use website that helps you and your team to create HMI designs for engineering



Connected & Secured

Pro-face connectivity

User-friendly protocols allowing you to connect your devices with ease via multiple interfaces and connect OT to IT with OPC-UA server.

Remote Visualization (BLUE Web Viewer Runtime)

Remote Visualization on PC or Tablet / Smartphone with new Web View features of BLUE.

See status of equipment or devices in the right place at the right time.



Secure remote access solution (Pro-face Connect)

"Pro-face Connect" is a ready-to-use solution for Remote Access Over Internet on ST6000 Series without programming or configuring each device. Start using the cloud based "Pro-face Connect" Smart Industry solution on your existing network without involving your IT department. No network or firewall configurations are required and still the highest level of security and encryption is in place from end to end, from any PC, tablet and smartphone to your machinery.

Enhanced cybersecurity against basic intentional attacks

- Need admin rights to download project to HMI target
- Auto user log out after predefined idle time
- Doing security checking during booting
- Secure Ethernet download supported by IPSec and password protected project file



Product Name	Model	Description		Supported models
BLUE Professional	PFXBLPCZLSPAZZ	Single license	Email	ST6000 Series, STM6000 Series, GP4100 Series Color model, SP5000 Series, PS6000 Series, PS5000 Series
	PFXBLPCZLGPA31	Group License	Virtual delivery	
	PFXBLPCZLTPA31	Team License	Virtual delivery	
BLUE Basic*1	PFXBLECZLSPAZZ	Single license	Email	ST6000 Series, STM6000 Series, GP4100 Series Color model
BLUE Runtime	PFXBLRCZLSPA31	Single license	Virtual delivery	PS5000 Series and PC / AT
BLUE Web Viewer Runtime	PFXWRT001	Single license	License Keycode	ST6000 Series, STM6000 Series, SP5000 Series, PS5000 Series
	PFXWRT010	10 Licenses		
	PFXWRT100	100 Licenses		

*1 Basic License doesn't support for WEB API and OPC-UA. OPC-UA Server is not supported on GP4100 Series Color model



website



manual



software



What's new

Screen editor software

GP-Pro EX



User friendly, yet powerful

Enables HMI screen and logic programming for all.

Screen creation can be performed with ease due to many functions that promote compatibility with legacy applications and reduce development time.

Connect directly to a wide range of field devices

Various drivers even for special devices from various vendors including parts library that offers advanced features without programming efforts.

Leverage existing assets

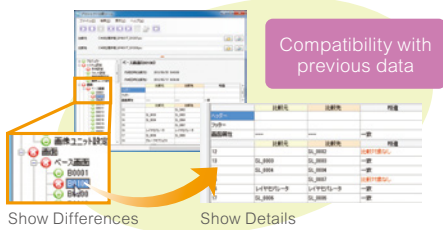

Project comparison function to quickly identify changes for quicker maintenance.

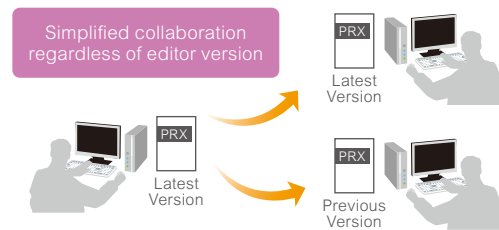

Save projects in older versions before sharing and hence reduce the installed versions on your PC.

User interface and soft controller editing in one software

Controller and screen addresses are applied directly via drag and drop, thus reducing the development time.

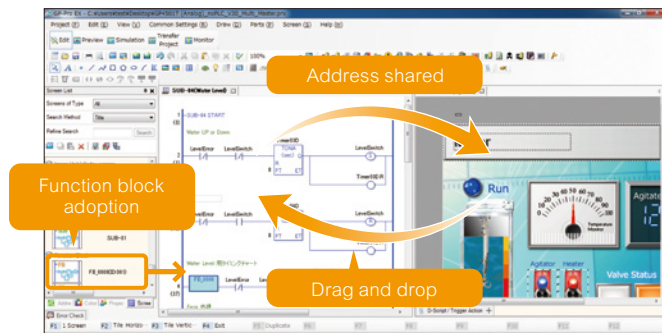

Runtime engine **WinGP**

Empower your Windows based PC with projects created by GP-Pro EX

Seamless communication with control equipment

No need to develop a driver to communicate with control equipment such as a PLC or temperature controller.

Cooperation with user database using dedicated API

Settings of WinGP are editable and device address read/write of the connected device can be done by the user application.

Model	Licenses	Description
PFXEXEDV**	1 license	GP-Pro EX editor license (license key, SW on DVD)
PFXEXEDLS**	1 license	GP-Pro EX editor license (license key, download SW from WEB)
PFXEXGRPLS**10	10 licenses	GP-Pro EX GROUP editor license (license key, download SW from WEB)
PFXEXGRPLS**25	25 licenses	
PFXEXGRPLS**50	50 licenses	
PFXEXWGIP	1 license	WinGP for compatible Pro-face IPC (license key code, download SW from WEB)
PFXEXWGPC	1 license	WinGP for general Windows PC (USB license key)

** is changed with the version of software.

Data management software

Pro-Server EX

Connect your machines to your IT environment for data sharing unlocking new insights for improvements.

Supplying real-time data for visualization and analysis of production sites. Remote machine monitoring and transfer of work instructions to increase efficiency between the production site and the office.



-  website
-  manual
-  software

Networking of the entire site to collect data collectively without programming

Collecting accurate information, and analyzing and utilizing all your data will lead to improvement in working processes!

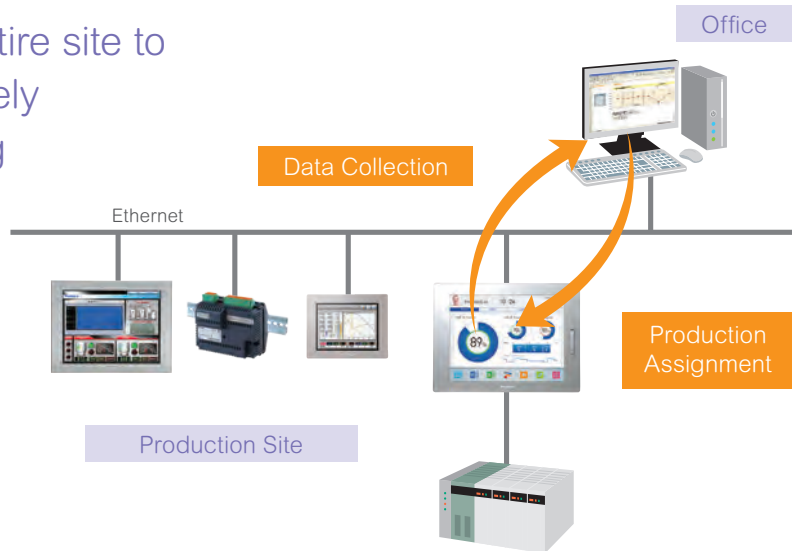

Remote Access

Pro-face Remote HMI

Software that enables tablets and smartphones to display and operate the exact same screen as the on-site HMI. Secure design with full-feature functions taking into consideration tablet operations.



Supported OS	Android OS, iOS (iPhone, iPad, iPod touch)
--------------	--

Download (purchase) from App Store / Google Play

Pro-face Remote HMI Server

Installing Pro-face Remote HMI Server on a Windows device allows users to monitor and operate Excel and PDF files from Pro-face Remote HMI, in addition to the terminal operator screens.

Model	Description
PFXEXRHLS	Software to operate and monitor Windows applications such as Excel or PDF besides Pro-face HMI screen

Pro-face Remote HMI Client for Win

More powerful Pro-face Remote HMI for Windows OS launched. While inheriting the functions of Pro-face Remote HMI, newly improved functions were added.

Model	Description
PFXEXRHCLS	1 License
PFXEXRHCLS10	10 Licenses
PFXEXRHCLS30	30 Licenses

Software for remote viewing of Pro-face HMI from desktop PC (license key code)



website



manual



software

Secure Remote Access over Internet

Pro-face Connect

VERSION UP

Connect and Go

Pro-face Connect is a ready-to-use embedded HMI service to access machines remotely and securely.



Small initial cost

No need to locate VPN router in every branch.
Able to operate the system with only the license of running cost.

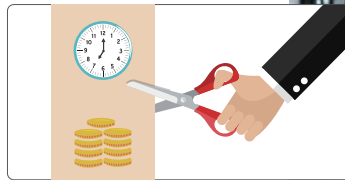

Able to use IP address with no change

Able to connect to the existing local IP address with no change.
No man-hours to change an IP address.

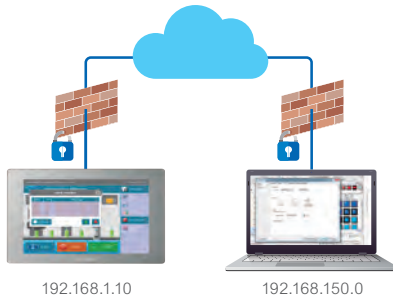

Connect securely

Conforms with industry level standards for security. Able to build a secure network.

- User access based on x.509 Cert.
- AES data encryption
- ISA99 and IEC 62443



Pro-face Connect

"Pro-face Connect" is a ready-to-use solution for Remote Access Over Internet on IPC, PS5000 Series and Smart Portal SP5000 Series without programming or configuring each device. Start using the cloud based "Pro-face Connect" Smart Industry solution on your existing network without involving your IT department. No network or firewall configurations are required and still the highest level of security and encryption is in place from end to end, from any PC, tablet and smartphone to your machinery.

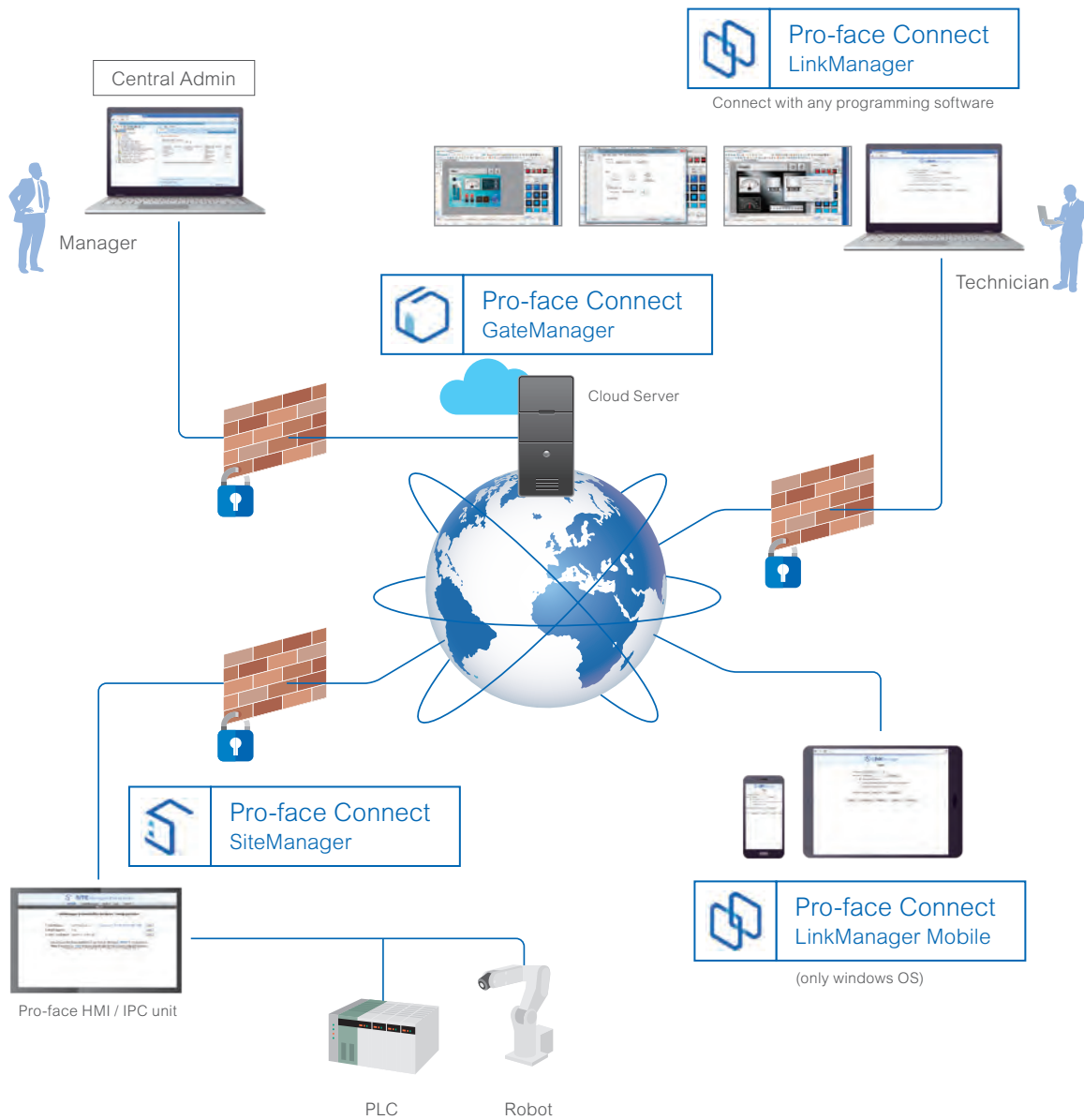

License Lineup

Product Name		Model No.	Description
Pro-face Connect 30 days Free Trial		PFXCONFREE30	Trial package running 30 days and including: 1 x Pro-face Connect GateManager License 1 x Pro-face Connect SiteManager Embedded Extended License, 5 device agents 1 x Pro-face Connect LinkManager License (floating license) 1 x Pro-face Connect LinkManagerMobile License
Basic Packs	Pro-face Connect Essential Pack	PFXCONPACKESS	1 x GateManager Customer Domain / 1 x LinkManager Floating License 1 x LinkManager Mobile License / 1 x SiteManager Extended 5 (Annual)
	Pro-face Connect Enterprise Pack	PFXCONPACKENT	1 x GateManager Customer Domain / 1 x LinkManager Floating License 1 x LinkManager Mobile License / 20 x SiteManager Extended 5 / 1 x GateManager Premium Access
Pro-face Connect LinkManager License		PFXCONLINK1	1 x Pro-face Connect LinkManager License
Pro-face Connect LinkManager Mobile License		PFXCONLINKM1	1 x Pro-face Connect LinkManager Mobile License
Pro-face Connect SiteManager Basic License		PFXCONSMBSCL	5 x Pro-face Connect SiteManager Embedded Basic License
Pro-face Connect SiteManager Extended 5 Licenses		PFXCONEXTD5	1 x Pro-face Connect SiteManager Embedded EXTENDED license, 5 device agents
Pro-face Connect SiteManager Extended 10 Licenses		PFXCONEXTD10	1 x Pro-face Connect SiteManager Embedded EXTENDED license, 10 device agents
Pro-face Connect GateManager Premium Access *1		PFXCONGMPREM	1 x GateManager Premium Access, Add-on option for Pro-face Connect Essential Pack license (PFXCONPACKESS)
User Statistics *1		PFXCONSTAT	Add-on option for Pro-face Connect Essential Pack license (PFXCONPACKESS) or Pro-face Connect / Enterprise Pack (PFXCONPACKENT)

*1 Not available in all areas, please contact your local office.



Web service

HMI Design Studio



Begin a new user experience with Pro-face HMI

HMI Design Studio is a creative yet easy-to-use website that helps you and your team to create HMI Applications

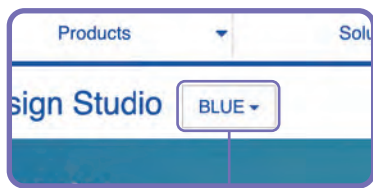

Software Selection



Online Tutorial

Learn skills to make yourself the best interface. Join today to get access to various types of courses.

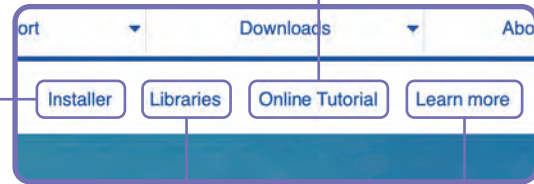

Installer

Download software (Full Installer / Trial Mode).

Libraries

Download over 300 kinds of ready-made template screens and parts or generate it by yourself.

Learn more

Knowledge base and community.



Template / Objects

Download various ready-made template screens and parts. You can import those into your BLUE and Blue Open Studio project files.

Intuitive layout template

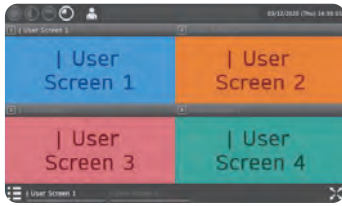

BLUE

Alarm Control

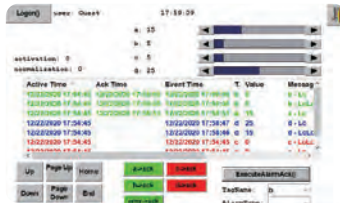

BLUE Open Studio

Icons

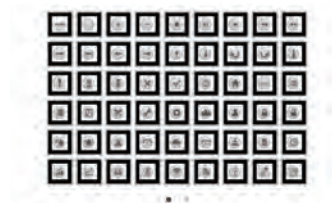

GP-Pro EX NEW

Dock Panel (Bottom)



BLUE

Database



BLUE Open Studio

Various switches

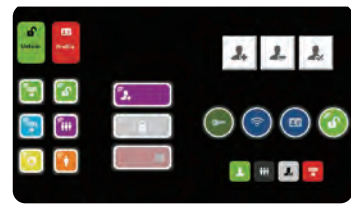

GP-Pro EX NEW



Images

BLUE BLUE Open Studio GP-Pro EX NEW

Download various industrial "Royalty-free" image files (*.png)



Customizable Icons

BLUE BLUE Open Studio GP-Pro EX NEW

Generate various icons according to your preference

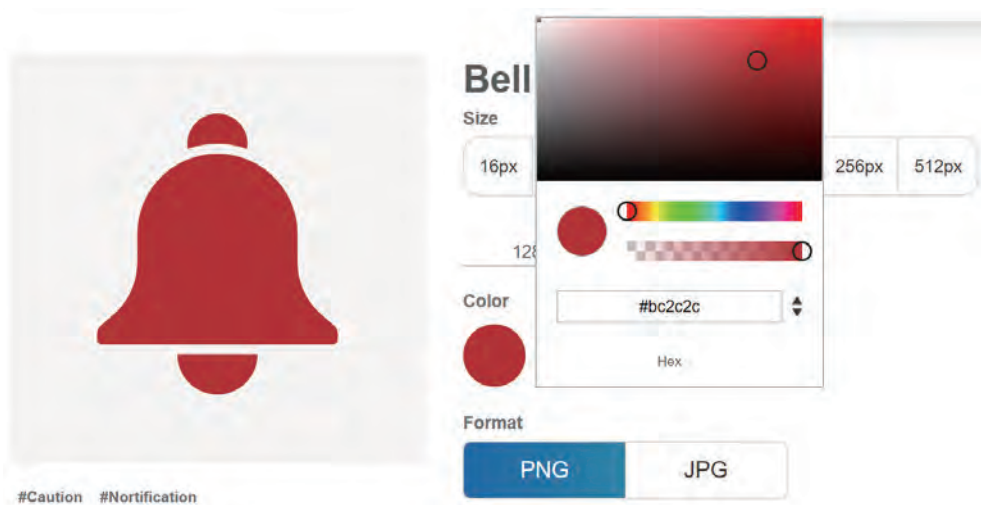

Customization and Services

Pro-face is experienced in providing HMI customization services based on specific needs.

Basic menu

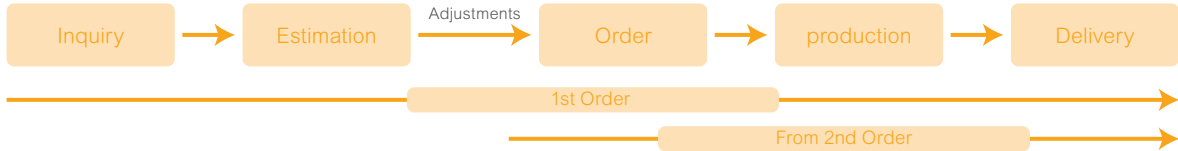

Kitting	Screen Protection Sheet / Environment Cover Enclose accessories in the package Screen data	GP-Viewer license keycode Customer's OS image Network address
Custom Overlays / Logos	Remove original logo Customer's logo (sticker type) Customer's logo (printed on overlay)	Change the color of overlay Add labels
Coating	Coat PCBAs	

Specific needs

We offer products outside the basic lineup to meet individual needs

Pro-face is experienced in providing HMI customization services based on specific needs

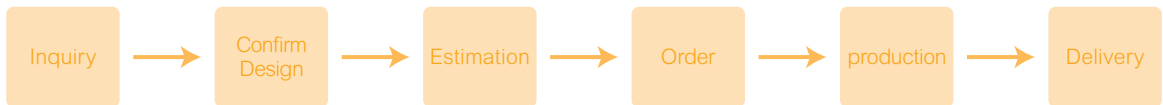

Embedded Camera

Operation log with video and image.

Target

Semiconductor / Electronics

SP5000 Series PFXSP5600TPD + SP5000 Series PFXSP5B41

Snapshot or video recording by switches on the screen

Rear Mount

Change the rear mount design to suit specific use or situation.

Target

Food & Beverage
Woodworking Machine

GP4100 Series PFXGP4116T2D

Flat on the surface

Pro-face Worldwide offices



<p>01 Japan</p> <hr/> <p>Schneider Electric Japan Holdings Ltd. Pro-face Japan Tokyo, JAPAN www.proface.com/ja</p>	<p>02 Australia</p> <hr/> <p>Pro-face by Schneider Electric New South Wales, AUSTRALIA www.proface.com.au</p>	<p>03 China</p> <hr/> <p>Pro-face China International Trading Shanghai, P.R.CHINA www.proface.com.cn</p>
<p>04 India</p> <hr/> <p>Pro-face by Schneider Electric Bangalore, INDIA www.proface.co.in</p>	<p>05 South Korea</p> <hr/> <p>Pro-face by Schneider Electric Seoul, SOUTH KOREA www.proface.co.kr</p>	<p>06 Singapore</p> <hr/> <p>Pro-face by Schneider Electric SINGAPORE www.proface.sg</p>
<p>07 Taiwan</p> <hr/> <p>Pro-face by Schneider Electric Taipei, TAIWAN www.proface.com.tw</p>	<p>08 Thailand</p> <hr/> <p>Pro-face by Schneider Electric Bangkok, THAILAND www.proface.com/en</p>	<p>09 Vietnam</p> <hr/> <p>Pro-face by Schneider Electric HCMC, Vietnam www.proface.com/en</p>
<p>10 Indonesia</p> <hr/> <p>Pro-face by Schneider Electric Jakarta, Indonesia https://www.proface.com/en/</p>	<p>11 Philippines</p> <hr/> <p>Pro-face by Schneider Electric Taguig, Philippines https://www.proface.com/en/</p>	<p>12 Malaysia</p> <hr/> <p>Pro-face by Schneider Electric Selangor Darul Ehsan, Malaysia https://www.proface.com/en/</p>
<p>13 America Headquarters</p> <hr/> <p>Pro-face America LLC, USA www.profaceamerica.com</p>	<p>14 Brazil</p> <hr/> <p>Pro-face America (Brazil office) Sao Paulo, BRAZIL www.profaceamerica.com</p>	<p>15 Canada</p> <hr/> <p>Pro-face by Schneider Electric Mississauga, Ontario, CANADA www.profaceamerica.com</p>
<p>16 Mexico</p> <hr/> <p>Pro-face America (Mexico office) Nuevo Leon, MEXICO www.profaceamerica.com</p>	<p>17 Austria</p> <hr/> <p>Pro-face by Schneider Electric Ratingen, GERMANY www.proface.com/en</p>	<p>18 Belgium</p> <hr/> <p>Pro-face by Schneider Electric Brussels, BELGIUM www.proface.com/en</p>
<p>19 Denmark and Sweden</p> <hr/> <p>Pro-face by Schneider Electric Ballerup, DENMARK www.proface.com/en</p>	<p>20 France</p> <hr/> <p>Pro-face by Schneider Electric Rueil-Malmaison, FRANCE www.proface.fr</p>	<p>21 Germany</p> <hr/> <p>Pro-face by Schneider Electric Ratingen, GERMANY www.proface.com/en</p>
<p>22 Italy</p> <hr/> <p>Pro-face by Schneider Electric Milano, ITALY www.proface.com/en</p>	<p>23 The Netherlands</p> <hr/> <p>Pro-face by Schneider Electric Hoofddorp, THE NETHERLANDS www.proface.com/en</p>	<p>24 Poland</p> <hr/> <p>Pro-face by Schneider Electric Warsaw, POLAND www.proface.com/en</p>
<p>25 Spain and Portugal</p> <hr/> <p>Pro-face by Schneider Electric Barcelona, SPAIN www.proface.com/en</p>	<p>26 Switzerland</p> <hr/> <p>Pro-face by Schneider Electric Ratingen, GERMANY www.proface.com/en</p>	<p>27 United Kingdom</p> <hr/> <p>Pro-face by Schneider Electric Coventry, UNITED KINGDOM www.proface.com/en</p>

Pro-faceTM

by **Schneider** Electric

[proface.com](https://www.proface.com)

Visit Pro-face web site for more information
<https://www.proface.com/en>

Contact Us (Worldwide Pro-face)
<https://www.proface.com/en/contact>

©2023 Schneider Electric Japan Holdings Ltd. All Rights Reserved.