



Page 22-2

SWITCHING BATTERY CHARGERS MODULAR VERSION

- For lead-acid batteries up to 50Ah rating
- Rated output current:
 - 2.5 and 4.5A at 12VDC
 - 1.25 and 2.5A at 24VDC
- Electronic lock for shorted battery, reverse polarity and output overload
- Automatic reset at end of alarm conditions
- Output for alarm remote indication.



Page 22-3 and 4

SWITCHING BATTERY CHARGERS

- For non-sealed and sealed lead-acid batteries up to 150Ah rating
- Rated output current:
 - 6A and 12A at 12VDC
 - 5A and 10A at 24VDC
- Electronic lock for shorted battery, reverse polarity and output overload
- Automatic reset at end of alarm conditions
- Output for alarm remote indication.
- Available versions with NFC technology for setup and RS485 integrated for setup, supervision and remote control.



Page 22-5

LINEAR BATTERY CHARGERS

- For lead-acid batteries up to 150Ah rating
- Rated output current:
 - 3A, 6A, 12A at 12VDC
 - 2.5A, 5A, 10A at 24VDC
- Electronic lock for shorted battery, reverse polarity, output overload and disconnected battery
- Output for alarm remote indication.



- Switching and linear technology
- 1 charging level
- Versions for non-sealed and sealed lead-acid batteries, 1.25 to 12A ratings
- Versions with RS485 and NFC communications integrated
- Charging current limitation selectable.

Automatic battery chargers for lead-acid batteries

	SEC. - PAGE
Switching BCF series, modular version	22 - 2
Switching BCG series	22 - 3
Switching BCG series, communicating version	22 - 4
Linear BCE series	22 - 5
Dimensions	22 - 6
Wiring diagrams	22 - 6
Technical characteristics	22 - 7

For lead-acid batteries. Modular version



BCF...

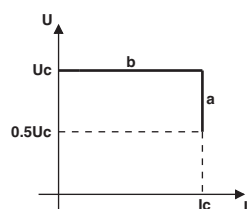

a - constant current charge
b - constant voltage charge

Order code	Rated output current [A]	Rated output voltage in DC [V]	Qty per pkg n°	Wt [kg]
------------	--------------------------	--------------------------------	----------------	---------

1 charging level.				
BCF 0250 12	2.5	12	1	0.332
BCF 0450 12	4.5		1	0.332

BCF 0125 24	1.25	24	1	0.332
BCF 0250 24	2.5		1	0.332

Alarms	VDC ON GREEN LED	BAT LOW RED LED	RELAY
Correct output voltage	ON	OFF	Energised
Reverse polarity	ON	ON	Energised
Short circuit/Overload	OFF	OFF	De-energised

Type	Maximum power consumption			Internal fuse mains side
	[VA]	[W]	[W]	[A]
BCF 0250 12	80	40	6	2ⓘ
BCF 0450 12	150	70	9	2ⓘ
BCF 0125 24	80	39	6	2ⓘ
BCF 0250 24	150	77	9	2ⓘ

ⓘ Not replaceable.

General characteristics

- Switching technology
- Wide auxiliary supply range
- Screw fixing or 35mm DIN rail mount (IEC/EN 60715).

Protection:

- Mains input fuse
- Battery output fuse
- Electronic lock in case of short circuit on battery terminals, reverse battery polarity and output overload
- Automatic reset at end of alarm conditions.

LED indications:

- Correct output voltage
- Reverse battery polarity.

Operational characteristics

- Auxiliary supply voltage: 100...240VAC $\pm 10\%$ 50/60Hz $\pm 5\%$
- Fixed charging current
- Current limitation
- Charging current according to DIN 41773 standards
- Fixed clamping screw terminal block with captive screws
- IEC degree of protection: IP20.

Alarm output circuit

- Type of output: 3A 250VAC AC1 duty relay, normally energised.

Certifications and compliance

Certifications obtained: EAC; UL Recognized for USA and Canada (cURus - File E360865), as Power Supplies - Component.

Products having this type of marking are intended for use as components of complete workshop-assembled equipment. Compliant with standards: IEC/EN 60950-1, IEC/EN 61000-6-2, IEC/EN 61000-6-3, UL 60950-1, CSA C22.2 n°60950-1.

For non-sealed and sealed lead-acid batteries



BCG...

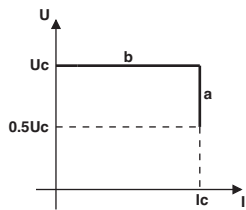

a - constant current charge
b - constant voltage charge

Order code	Rated output current [A]	Rated output voltage in DC [V]	Qty per pkg n°	Wt [kg]
1 charging level.				
BCG 06 12	6	12	1	0.532
BCG 12 12	12		1	0.710
BCG 05 24	5	24	1	0.532
BCG 10 24	10		1	0.710
Accessories.				
BCG X00	Adapter for 35mm DIN rail vertical mount of BCG 06 12 and BCG05 24		1	0.022

Alarms	ON GRN LED	REV RED LED	ALA RED LED	CHG YEL RED	RELAY
Correct output voltage	ON	OFF	OFF	OFF	Energ.
Charging	ON	OFF	OFF	ON [⊗]	Energ.
Low battery voltage	ON	OFF	ON	ON [⊗]	Energ.
Reverse polarity	OFF	ON	OFF	OFF	De-energ.
Short circuit / Overload	ON	OFF	ON	OFF	De-energ.

⊗ Steady light if the charging current is more than approx. 30% of programmed current value.

⊗ Flashing during Hiccup operating conditions.

Type	Maximum power consumption			Internal fuse Mains side (type T)
	[VA]	[W]	[W]	
BCG 06 12	230	97	14	4 [Ⓛ]
BCG 12 12	284	290	29	6.3
BCG 05 24	364	158	20	6.3 [Ⓛ]
BCG 10 24	630	311	41	8

Ⓛ Not replaceable.

General characteristics

- Switching technology
- Wide auxiliary supply range
- High efficiency
- Two charging voltages selectable by DIP-switch
- Boost external control for full battery charging
- Hiccup function for battery recharging when its voltage is lower than 50% rated value
- Charging current limiting trimmer resistor
- Screw fixing or 35mm DIN rail mount (IEC/EN 60715).
- Protection:
 - Input fuse on AC side
 - Electronic lock in case of short circuit on battery terminals, reverse battery polarity and output overload
 - Automatic reset at end of alarm conditions.
- LED indications:
 - Power on
 - Charging operation ($I > 30\% I_c$)
 - Overload or short circuit conditions
 - Reverse battery polarity.

Operational characteristics

- Auxiliary supply voltage: 110...240VAC $\pm 10\%$ 50/60Hz $\pm 10\%$
- Charging voltage selectable by DIP-switch
 - Non-sealed lead-acid batteries
 - Sealed lead-acid batteries
- Maximum charging current can be set with a trimmer on the front: 20...100% of the rated current value
- Current limitation
- Charging cycle according to DIN 41773 standards
- IEC degree of protection: IP20.

Alarm output circuit

- Type of output: 5A 30VDC duty relay, normally energised.

Certifications and compliance

Certifications obtained: EAC; UL Recognized for USA and Canada (cURus - File E360865), as Power Supplies - Component.
Products having this type of marking are intended for use as components of complete workshop-assembled equipment.
Compliant with standards: IEC/EN 60950-1, IEC/EN 61000-6-2, IEC/EN 61000-6-4, UL 60950-1, CSA C22.2 n°60950-1.

For non-sealed and sealed lead-acid batteries



BCG...RS

new

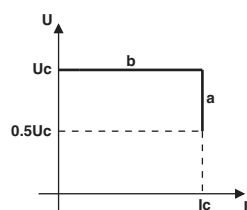

a - constant current charge
b - constant voltage charge

Order code	Rated output current	Rated output voltage in DC	Qty per pkg	Wt
	[A]	[V]	n°	[kg]
1 charging level.				
BCG 06 12 RS	6	12	1	0.582
BCG 12 12 RS	12		1	0.760
Accessories.				
BCG X00	Adapter for 35mm DIN rail vertical mount of BCG 06 12RS and BCG05 24RS		1	0.022

Alarms	ON GRN LED	REV RED LED	ALA RED LED	CHG YEL LED	RELAY
Correct output voltage	ON	OFF	OFF	OFF	Energ.
Charging	ON	OFF	OFF	ON ^①	Energ.
Low battery voltage	ON	OFF	ON	ON ^②	Energ.
Reverse polarity	OFF	ON	OFF	OFF	De-energ.
Short circuit / Overload	ON	OFF	ON	OFF	De-energ.

- ① Steady light if the charging current is more than approx. 30% of programmed current value.
- ② Flashing during Hiccup operating conditions.

Type	Maximum power consumption dissipation			Internal fuse Mains side (type T)
	[VA]	[W]	[W]	[A]
BCG 06 12RS	230	97	14	4 ^③
BCG 12 12RS	284	290	29	6.3
BCG 05 24RS	364	158	20	6.3 ^③
BCG 10 24RS	630	311	41	8

③ Not replaceable.



- Setup configuration with:
 - NFC connection and the app LOVATO Electric **NFC**;
 - **Synergy** supervision and energy management software
 - **Xpress** configuration and remote control software
- Supervision of measures, states and alarms with **Synergy** or **Xpress**
- Automatic and programmable BOOST function
- Compatibility with automatic transfer switch controllers ATL800, ATL900 and gen-set controllers RGK800 and RGK 900: it is possible to display the battery charger status on dedicated pages of the controllers.

General characteristics

The BCG battery chargers with the built-in communication have integrated functions necessary where is needed the permanent control of the battery state of charge (SOC):

- Supervision and remote control
- Communication with the compatible devices (ATL 800, ATL 900, RGK 800, RGK 900) and display the battery charger status on dedicated pages
- Battery disconnected alarm
- Double supply for the built-in RS485 communication that allows a permanent supervision in case of emergency
- Switching technology
- Wide auxiliary supply range
- High efficiency
- Isolated RS485 communication
- RTU and ASCII Modbus protocols
- Charging voltage selectable in function of the battery type (Pb – Sealed Pb – Ni-Cd):
 - 12V models: 12...15 VDC
 - 24V models: 24...30 VDC
- BOOST external command or via Modbus to deep charge of the battery
- Hiccup function for battery recharging when its voltage is lower than 50% rated value
- Charging current limiting trimmer resistor
- Screw fixing or 35mm DIN rail mount (IEC/EN 60715).

Protection:

- Input fuse on AC side
- Electronic lock in case of short circuit on battery terminals, reverse battery polarity and output overload, battery not connected
- Signalling absence of auxiliary power supply AC
- Automatic reset at end of alarm conditions.

LED indications:

- Power on
- Charging operation (>30% I_c)
- Overload or short circuit conditions
- Reverse battery polarity.

Operational characteristics

- Auxiliary supply voltage: 110...240VAC ±10% 50/60Hz ±10%
- Parameters can be set with RS485 or NFC connection:
 - Current limit: 20...100% of the rated current value
 - Charging voltage
 - Boost voltage
 - Boost interval
 - Boost duration
- Current limitation
- Charging cycle according to DIN 41773 standards
- IEC degree of protection: IP20.

Alarm output circuit

- Type of output: 5A 30VDC duty relay, normally energised.

App for smartphones and tablets

The app LOVATO Electric **NFC**, installed on Android devices with NFC connectivity, allows the user to set the parameters of BCG ... RS.

For more information see section 27.

Synergy supervision and energy management software

See section 27.

Xpress configuration and remote control software

See section 27.

Certifications and compliance

Certifications pending: EAC; UL Recognized for USA and Canada (cURus - File E360865), as Power Supplies - Component.

Products having this type of marking are intended for use as components of complete workshop-assembled equipment.

Compliant with standards: IEC/EN 60950-1, IEC/EN 61000-6-2, IEC/EN 61000-6-4, UL 60950-1, CSA C22.2 n°60950-1.

For lead-acid batteries



31 BCE 0312
31 BCE 2V524



31 BCE 0612
31 BCE 0524



31 BCE 1212
31 BCE 1024

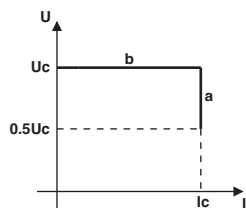

a - constant current charge
b - constant voltage charge

Order code	Rated output current	Rated output voltage in DC	Qty per pkg	Wt
	[A]	[V]	n°	[kg]

1 charging level.				
31 BCE 0312	3	12	1	1.984
31 BCE 0612	6		1	4.832
31 BCE 1212	12		1	8.690

31 BCE 2V524	2.5	24	1	1.992
31 BCE 0524	5		1	4.960
31 BCE 1024	10		1	9.560

Type	Maximum power consumption	dissipation	Mains fuse (type)
	[VA]	[W]	[A]
BCE 0312	117	24	1 (T) ext ❶
BCE 0612	222	46	4 (F) int
BCE 1212	400	73	6.3 (F) int
BCE 2V524	166	26	1 (T) ext ❶
BCE 0524	317	40	4 (F) int
BCE 1024	610	66	6.3 (F) int

❶ Not supplied; installed by customer.

DERATING CURVES

BCE 2V5 - BCE 03

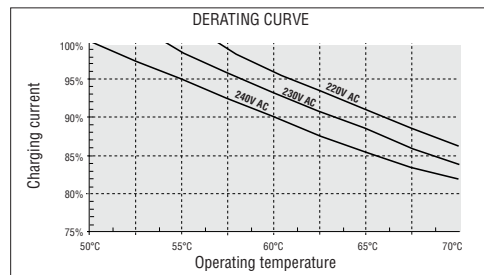

BCE 05 - BCE 06

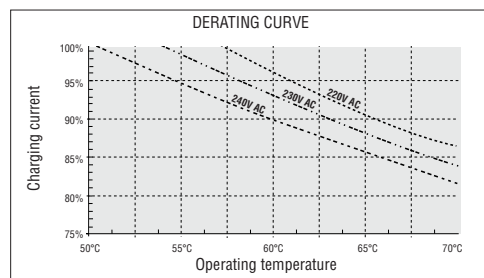

BCE 10 - BCE 12

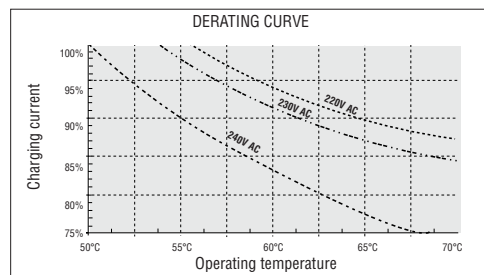

General characteristics

- Linear technology
- Housing for internal panel mounting by screws.
- Protection:
 - Mains input fuse (except for BCE 2V5 and BCE 03)
 - Battery output fuse
 - Electronic lock in case of short circuit on battery terminals, reverse battery polarity, output overload (<math><0.5 U_e</math>) and disconnected battery.

LED Indications:

- Power on
- Charge ($I > 0.2 I_c$)
- Alarm for protection tripping.

Operational characteristics

- Auxiliary supply voltage: 220...240VAC $\pm 10\%$, 50/60Hz $\pm 5\%$
- Charging current: 30...100% I_e adjustable
- Charging cycle according to DIN 41773 standards
- Current limitation
- Clamping screw terminal block with captive screws:
 - Removable for BCE 03 and BCE 2V5
 - Fixed for BCE 05, BCE 06, BCE 10 and BCE 12
- IEC degree of protection: IP00.

Alarms

Possible causes of alarm include:

- Low battery voltage
- Battery fuse blown
- Battery not connected
- Battery polarity inverted (reverse polarity).

BCE 2V524 - BCE 0312

These types have a static alarm output for the control of a relay or indicator, maximum 300mA duty.

If it is connected to a relay, this must be normally energised in absence of alarm. In alarm conditions with ALARM LED switched on or in absence of supply, the relay de-energises.

BCE 0524 - BCE 0612 - BCE 1024 - BCE 1212

These types have a normally energised relay alarm output. In alarm conditions with ALARM LED switched on or in absence of supply, the relay de-energises.

Alarm output circuit

BCE 2V524 - BCE 0312

- Type of output:
 - Negative static; NPN transistor ❶
 - Maximum voltage applicable to load: +V battery terminal
 - Maximum output current: 300mA
 - Maximum overload current for 1 second: 2A
 - Dynamic over-voltage protection with inductive load.

BCE 0524 - BCE 0612 - BCE 1024 - BCE 1212

- Type of output
 - Relay: 1 changeover contact (SPDT)
 - Rated voltage: 250VAC
 - IEC rated capacity in AC1 duty: 5A 250VAC I_{th}
 - IEC rated capacity in DC13 or DC14 duty: 5A 30VDC
 - Electrical life: $>10^9$ cycles
 - Mechanical life: $>30 \times 10^9$ cycles.

❶ The output is not overload or short-circuit protected. It is however capable of switching on a 3W filament bulb.

Certifications and compliance

Certifications obtained: EAC.
Compliant with standards: IEC/EN 60335-2-29.

BCF...

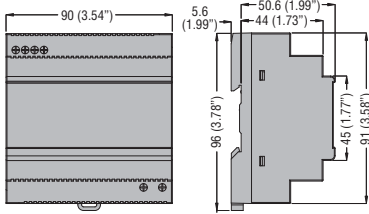

BCG 0612 - BCG 0524 - BCG 0612RS - BCG 0524RS

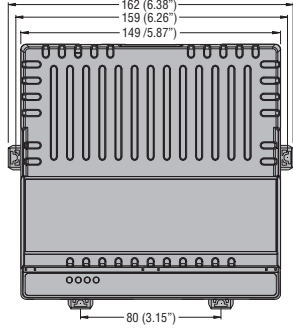

Mounting adapter BCG X00

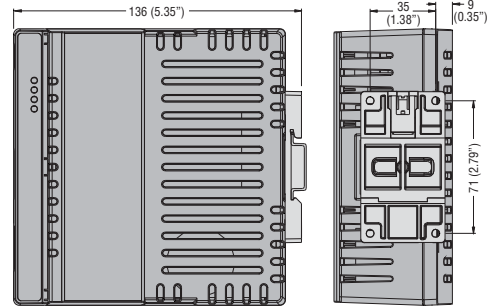

BCG 1212 - BCG 1024 - BCG 1212RS - BCG 1024RS

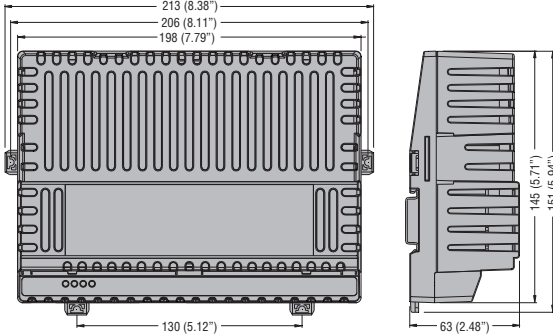

BCE 0312 - BCE 2V524

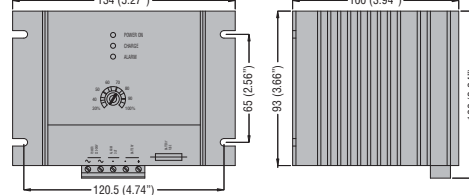

BCE 0612 - BCE 0524

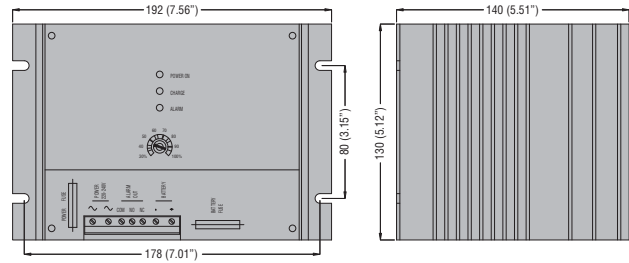

BCE 1212 - BCE 1024

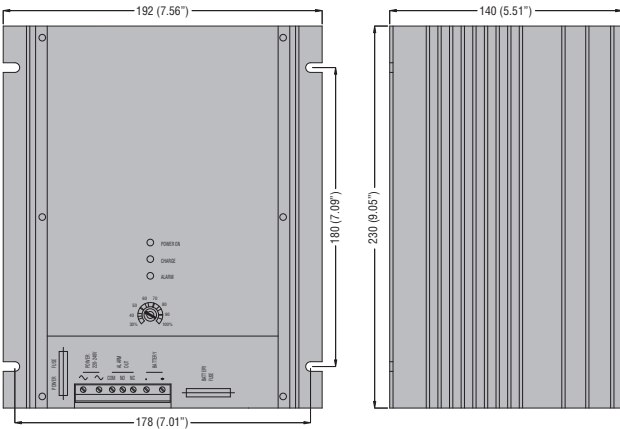

Wiring diagrams

BCF...

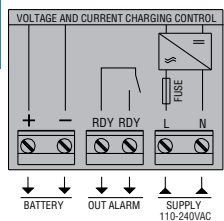

BCG...

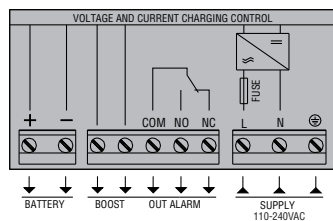

BCG...RS

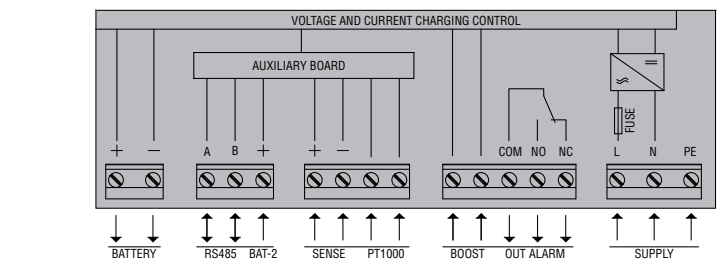

BCE 2V5... - BCE 03...

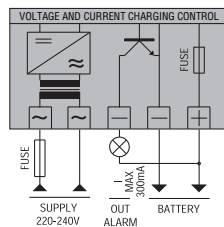

BCE 05... - BCE 06... - BCE 10... - BCE 12...

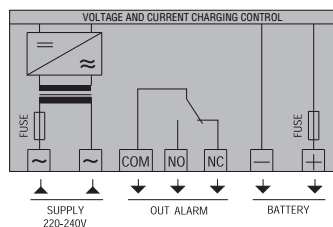

BCG 0612 - 8A T

BCG 0524 - 6.3A T

BCG 1212 - 16A T

BCG 1024 - 12.5A T

LOAD

FUSE

1A T FUSE

FUSE

TYPE	BCG... - BCG...RS	BCF...	BCE...
Description	Single phase automatic battery charger 1 charging level for sealed and non-sealed lead-acid batteries	Single phase automatic battery charger 1 charging level for lead-acid batteries	
Supply voltage	110-240VAC ±10% 50/60Hz ±10%	100-240VAC ±10% 50/60Hz ±5%	220-240VAC ±10% 50/60Hz ±5%
Rated output voltage (Uoc)	12-24VDC		
Rated charging current (Ic)	6-12A (12VDC) 5-10A (24VDC)	2.5-4.5A (12VDC) 1.25-2.5A (24VDC)	3-6-12A (12VDC) 2.5-5-10A (24VDC)
CHARGING CYCLE			
Reference standards	DIN 41773		
Diagram	<p>a - constant current charge b - constant voltage charge</p>		
End charging voltage Uc	For BCG... 12V battery with DIP2: – in pos. V1: 13.8V – in pos. V2: 13.5V (default). 24V battery with DIP2: – in pos. V1: 27.6V – in pos. V2: 27.0V (default) For BCG...RS 12V battery: adjustable 13.5...13.8V with NFC or RS485 24V battery: adjustable 27.0...27.6V with NFC or RS485	12V battery: 13.6VDC (2.27V/cell) 24V battery: 27.2VDC (2.27V/cell)	12V battery: 13.8VDC (2.3V/cell) 24V battery: 27.6VDC (2.3V/cell)
Charging current	For BCG... adjustable 20% to 100% Ic (using potentiometer/trimpot) For BCG...RS adjustable 20% to 100% Ic with NFC or RS485	Fixed	Adjustable 30% to 100% Ic (using potentiometer)
Current limit	Yes		
Boost	+4.4% Uc	—	—
PROTECTION			
Type	– Mains supply fuse – Charging inhibition due to: • Short circuit at battery terminals • Reverse battery polarity • Low voltage at battery poles (<0.5 Uoc) • Output overload • Disconnected battery only for communicating version	– Mains supply fuse – Charging inhibition due to: • Short circuit at battery terminals • Reverse battery polarity • Low voltage at battery poles (<0.5 Uoc) • Output overload	– Mains supply fuse (5, 6, 10, 12A types only) – Battery output fuse – Charging inhibition due to: • Short circuit at battery terminals • Reverse battery polarity • Low voltage at battery poles (<0.5 Uoc) • Disconnected battery
ALARM OUTPUT CIRCUIT			
Type of output	1 relay 5A 30VDC	1 relay 3A 250VAC AC1	Static (NPN transistor) ①; relay with 1 c/o contact (SPDT), 5A 250VAC ②
AMBIENT CONDITIONS			
Operating temperature	-30...+55°C (+55...+70°C with 1-5%Ic/°C derating by trimpot)	-40...+51°C	-10...+50°C
Storage temperature	-30...+80°C	-40...+85°C	-30...+80°C
HOUSING			
Version	Internal panel mount	Modular	Internal panel mount
IEC degree of protection	IP20	IP20	IP00
Cooling	Natural		
Connections	Fixed terminals	Fixed terminals	Removable/plug-in terminals① Fixed terminals②

① For 2.5A and 3A types only.
② For 5, 6, 10 and 12A types only.

HELSINKI
tel. +358 9 540 4940
info@klinkmann.fi

ST. PETERSBURG
tel. +7 812 327 3752
klinkmann@klinkmann.spb.ru

MOSCOW
tel. +7 495 641 1616
moscow@klinkmann.spb.ru

YEKATERINBURG
tel. +7 343 287 19 19
yekaterinburg@klinkmann.spb.ru

SAMARA
tel. +7 846 273 95 85
samara@klinkmann.spb.ru

UFA
tel. +7 347 293 70 04
klinkmann@klinkmann.ru

KIEV
tel. +38 044 495 33 40
klinkmann@klinkmann.kiev.ua

KAZAKHSTAN
tel. +7779994825
sales@klinkmann.kz

MINSK
tel. +375 17 200 0876
minsk@klinkmann.com

RIGA
tel. +371 6738 1617
klinkmann@klinkmann.lv

VILNIUS
tel. +370 5 215 1646
post@klinkmann.lt

TALLINN
tel. +372 668 4500
klinkmann.est@klinkmann.ee



www.klinkmann.com