

DTSU666 series three phase four wire electronic energy meter

DSSU666 series three phase three wire electronic energy meter

# User Manual

ZTY0.464.1448

Zhejiang Chint Instrument & Meter Co., Ltd.

Apr., 2022.

DTSU666 series and DSSU666 series three phase electronic energy meter	ZTY0.464.1448
User manual	Page 1, Total 21

---

## 1. Brief Introduction

### 1.1 Main application & applicable range

DTSU666 series three phase four wire and DSSU666 series three phase three wire electronic energy meter (din-rail) (hereinafter referred to as the “instrument”) is designed based on power monitoring and energy metering demands for electric power system, communication industry, construction industry, etc. as a new generation of intelligent instrument combining measurement and communication function, mainly applied into the measurement and display for the electric parameters in the electric circuit including three voltage, three current, active power, reactive power, frequency, positive& negative energy, four-quadrant energy, etc. Adopting the standard DIN35mm din rail mounting and modular design, it is characterized with small volume, easy installation and easy networking, widely applied into the internal energy monitoring and assessment for industrial and mining enterprises, hotels, schools, large public buildings.

Complied standards:

IEC 61010-1:2010 《Safety requirements for electrical equipment for measurement, control and laboratory use Part1:General requirements》

IEC 61326-1:2013 《Electrical equipment for measurement, control and laboratory use –EMC requirements Part1:General requirements》

MODBUS-RTU protocol.

### 1.2 Product Features

- 1) Characterized with positive and reverse active power, combined active power, combined reactive power, four quadrant reactive power metering and storage function with combination mode character can be set.
- 2) RS485 communication function with communication protocol complied with Modbus-RTU.
- 3) Adopting the standard DIN35mm din rail mounting and modular design, it is characterized with small volume, easy installation and easy networking.
- 4) The update speed of active power is better than 120ms.

DTSU666 series and DSSU666 series three phase electronic energy meter	ZTY0.464.1448
User manual	Page 2, Total 21

### 1.3 Product model

Table 1 product model and specification

Model	Reference voltage (V)	Current specification (A)	Impulse constant		Accuracy class
			imp/kWh	imp/kvarh	
DTSU666-CT	3×220/380V...	0.015-1.5(6)A	6400	6400	active energy EN 50470-3:Class C
DTSU666	3×240/415V	0.25-5(80)A	400	400	active energy EN 50470-3:Class B
DTSU666	3×230/400V OR 3×220/380V	1.5(6)A	6400	6400	Active class 0.5S,reactive class 2
		5(80)A	400	400	Active class 1. Reactive class 2
DSSU666	3×400V OR 3×380V	1.5(6)A	6400	6400	Active class 0.5S,reactive class 2
		5(80)A	400	400	Active class 1. Reactive class 2
DTSU666	3×277/480V Customized specifications	1.5(6)A	6400	6400	Active class 0.5S,reactive class 2
		5(80)A	400	400	Active class 1. Reactive class 2
DSSU666	3×480V Customized specifications	1.5(6)A	6400	6400	Active class 0.5S,reactive class 2
		5(80)A	400	400	Active class 1. Reactive class 2

Note1: 0.015-1.5(6)A is Connection through current transformers,starting current is 0.015A;

Note2: 0.25-5(80)A is direct access,starting current is 0.02A;

Note3: 1.5 (6)A is connected through current transformer, 5 (80) A is directly connected. In order to meet the requirements of different countries and regions, the specifications are slightly different, subject to the actual object.

Note4: The above voltage specifications support 3×127/220V and 3×57.7/100V access.

Note5: Customized specification 3×277/480V are only suitable for specific occasions, the voltage of line A must be above 100V. The maximum phase voltage does not exceed 310V(three-phase four-wire),

DTSU666 series and DSSU666 series three phase electronic energy meter	ZTY0.464.1448
User manual	Page 3, Total 21

and the maximum line voltage does not exceed 540V(three-phase three-wire),Suitable for specific occasions

#### 1.4 Model composition and meanings

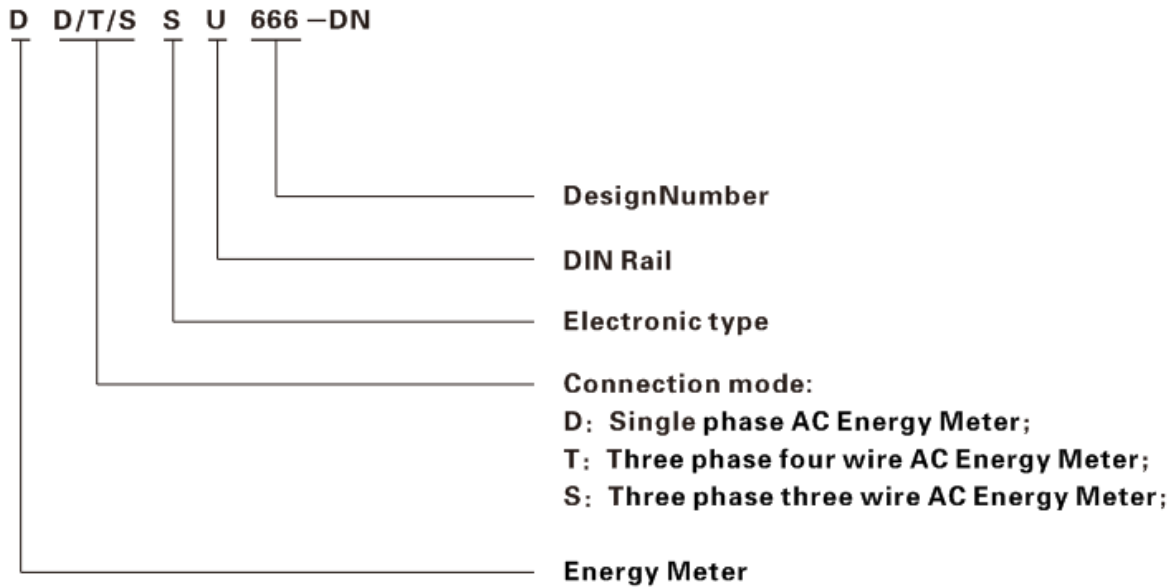

Figure 1 Model composition and meanings

#### 1.5 Applicable environmental condition

##### 1.5.1 Temperature range

Indoor type:

Regulated working temperature range:  $-10^{\circ}\text{C} \sim +45^{\circ}\text{C}$ ;

Limited working temperature range:  $-25^{\circ}\text{C} \sim +75^{\circ}\text{C}$ ;

##### 1.5.2 Relative humidity(Annually average): $\leq 75\% \text{RH}$ ;

1.5.3 Atmospheric pressure:  $63.0\text{kPa} \sim 106.0\text{kPa}$ ( altitude 4km and below), excepting the requirements for special orders.

#### 2. Working Principle

The instrument are composed of high accurately integrated circuit specially for measurement (ASIC) and managing MCU, memory chip, RS485 communication module, etc.

The working principle block diagram of the instrument is shown in figure 2

DTSU666 series and DSSU666 series three phase electronic energy meter	ZTY0.464.1448
User manual	Page 4, Total 21

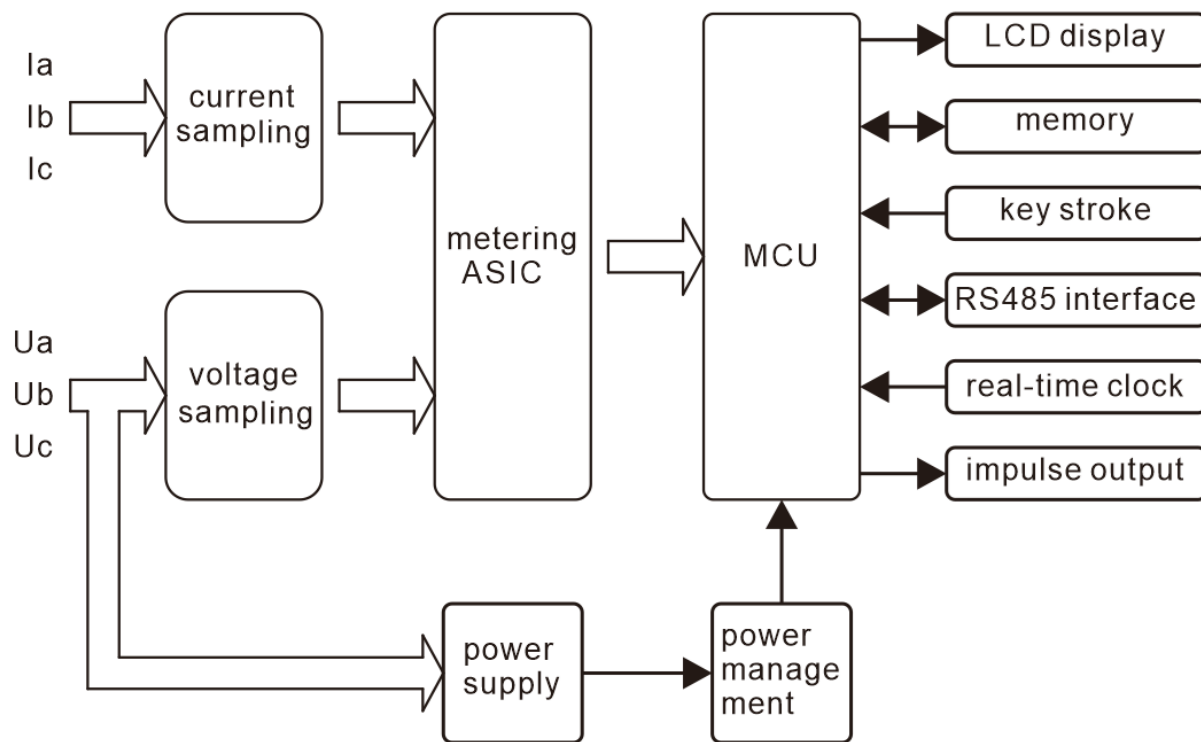

Figure 2 Working principle block diagram

## 2.1.Principle for the main function module

### 2.1.1.Metering part

The special metering integrated circuit (ASIC) integrated six load two order  $\Sigma$ - $\Delta$  type of A/D conversion, please take the digital signal processing measured by the voltage circuit as well as all the power, energy, effective values, power factor and frequency. This metering chip can measure the active power, reactive power, apparent power, active energy, reactive power, apparent energy of each phase and combined phase, and at the same time measuring current, voltage effective values, power factor, phase angle, frequency and other parameters, entirely satisfying the needs of power meter. The chip provides an SPI interface, convenient for metering parameters as well as parameter calibration between the management MCU.

### 2.1.2.Data processing part

Management MCU will timely read the electrical parameters such as current, voltage, power, etc. in the metering chips, judging the current quadrant based on the read data, and judging the current

DTSU666 series and DSSU666 series three phase electronic energy meter	ZTY0.464.1448
User manual	Page 5, Total 21

operated rate based on time and time rate, then adding the energy read from the metering chip to the corresponding quadrant energy and total energy based on the rate and quadrant, at the same time, calculating the corresponding combined energy based on the energy combination mode, and then store and backup the energy.

The management MCU drives LCD module to display and exchange data with the outside through RS485 communication interface.

### 3. Main Technical Performance & Parameters

#### 3.1. limit of error caused by the current augment

Table 2 The limit value of the active percentage error of meters on balanced load

type	Range of current	Power factor	Percentage error limit of various grade instruments (%)		
			0.5S	Class 1	Class 2
Access via current transformer	$0.01I_n \leq I < 0.05I_n$	1	±1.0	±1.5	±2.0
	$0.05I_n \leq I \leq I_{max}$	1	±0.5	±1.0	±1.2
	$0.02I_n \leq I < 0.1I_n$	0.5L、0.8C	±1.0	±1.5	±2.0
	$0.1I_n \leq I \leq I_{max}$	0.5L、0.8C	±1.0	±1.0	±1.2
Direct access instrument	$0.05I_b \leq I < 0.1I_b$	1	-	±1.5	±2.0
	$0.1I_b \leq I \leq I_{max}$	1	-	±1.0	±1.2
	$0.01I_b \leq I < 0.2I_b$	0.5L、0.8C	-	±1.5	±2.0
	$0.2I_b \leq I \leq I_{max}$	0.5L、0.8C	-	±1.0	±1.2
Remark	$I_n$ : secondary rated current of the current transformer; $I_b$ : calibrated current of the meter; L: inductive; C: capacitive;				

Table 3 The limit value of the reactive percentage error of meters on balanced load

Current value		sinφ (inductive or capacitive)	Percentage error limit of various grade instruments (%)
Direct access instrument	Access via transformer		
$0.05I_b \leq I < 0.1I_b$	$0.02I_n \leq I < 0.05I_n$	1	±2.5

DTSU666 series and DSSU666 series three phase electronic energy meter	ZTY0.464.1448
User manual	Page 6, Total 21

$0.1I_b \leq I \leq I_{max}$	$0.05I_n \leq I \leq I_{max}$	1	$\pm 2.0$
$0.1I_b \leq I < 0.2I_b$	$0.05I_n \leq I < 0.1I_n$	0.5	$\pm 2.5$
$0.2I_b \leq I \leq I_{max}$	$0.1I_n \leq I \leq I_{max}$	0.5	$\pm 2.0$
$0.2I_b \leq I \leq I_{max}$	$0.1I_n \leq I \leq I_{max}$	0.25	$\pm 2.5$

Table 4 The limit value of the active percentage error of meters on imbalanced load

Current value		Power factor	Percentage error limit of various grade instruments (%)		
Direct access instrument	Access via transformer		0.5S	Class 1	Class 2
$0.1 I_b \leq I \leq I_{max}$	$0.05I_n \leq I \leq I_{max}$	1	$\pm 0.6$	$\pm 2.0$	$\pm 3.0$
$0.2I_b \leq I \leq I_{max}$	$0.1I_n \leq I \leq I_{max}$	0.5L	$\pm 1.0$	$\pm 2.0$	$\pm 3.0$

Table 5 The limit value of the reactive percentage error of meters on imbalanced load

Current value		Current value	Percentage error limit of various grade instruments (%)
Direct access instrument	Direct access instrument		Class 2
$0.1 I_b \leq I \leq I_{max}$	$0.05I_n \leq I \leq I_{max}$	1	$\pm 3.0$
$0.2I_b \leq I \leq I_{max}$	$0.1I_n \leq I \leq I_{max}$	0.5	$\pm 3.0$

### 3.2. Start

Under the power factor of 1.0 and started current, the instrument can be started and continuously measure (for multiple phase instrument, it will bring balanced load). If the instrument is designed based on measurement for dual directional energy, then it is applicable for each direction of energy.

Table 6 start current

instrument	Instrument rating			Power factor
	0.5S	1	2	
Direct access instrument	-	$0.004I_b$	$0.005I_b$	1
Access via CT	$0.001I_b$	$0.002I_b$	$0.003I_b$	1

### 3.3. Defluction

When adding voltage while there is no current on the current circuit, the test output of the instrument shall not produce another pulse. When testing, the current circuit shall be opened, and the

DTSU666 series and DSSU666 series three phase electronic energy meter	ZTY0.464.1448
User manual	Page 7, Total 21

added voltage for voltage circuit shall be 115% of the referenced voltage.

Shortest testing time  $\Delta t$  :

For instrument of class 0.5S and class1: 
$$\Delta t \geq \frac{600 \times 10^6}{k \cdot m \cdot U_n \cdot I_{max}} [min]$$

For instrument of class 2: 
$$\Delta t \geq \frac{480 \times 10^6}{k \cdot m \cdot U_n \cdot I_{max}} [min]$$

From the formula, k represents meter constant (imp/kWh), m represents measuring components, Un represents referenced voltage (V) and Imax represents the maximized current (A).

### 3.4. Electrical parameters

Table 7 Electrical parameters

Specified operating voltage range	0.9Un~1.1Un	
Extended operating voltage range	0.8Un~1.15Un	
Ultimate operating voltage range	0 Un~1.15Un	
Power consumption of the voltage circuit	≤1.5W and 6VA	
Power consumption of the current circuit	I <sub>b</sub> <10A	≤0.2VA
	I <sub>b</sub> ≥10A	≤0.4VA
Data save time after power off	≥10 years	

### 4. Key components adoption

Table 8 Key components adoption

Model	DTSU666
Metering chip	HT7036
Crystal oscillator	5.5296MHz, 32.768kHz
Printed PCB	ZTY8.067.2267, ZTY8.067.2837, ZTY8.067.2288
Power transformer	EE19-0.9mH-B
Current	HLX1



DTSU666 series and DSSU666 series three phase electronic energy meter	ZTY0.464.1448
User manual	Page 8, Total 21

transformer	
-------------	--

## 5.Main function

### 5.1.Displayed function

From the displayed interface, the electrical parameter and energy data are all primary side data (that is, the multiplied by current and voltage ratios). The energy measuring value will be displayed seven bits, with the displaying range from 0.00kWh to 9999999MWh.

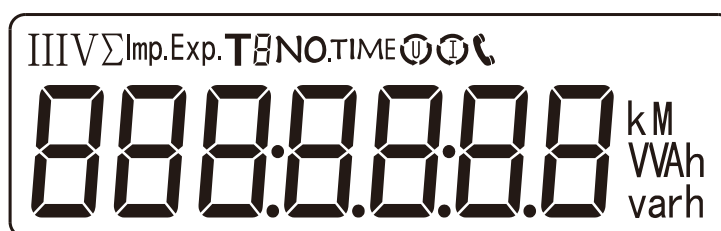











Figure 3 Liquid crystal display

Table 9 Display interface

No.	Display interface	Instruction	No.	Display interface	Instruction
1		Combined active energy =10000.00kWh	11		Phase C current =5.002A
2		Forward active energy =10000.00kWh	12		Combined phase active power =3.291kW
3		Reserve active energy =2345.67kWh	13		Phase A active power =1.090kW
4		Protocol: ModBus-RTU; address =001	14		Phase B active power =1.101kW
5		Baudrate=9600 None parity, 1 stop bits	15		Phase C active power =1.100kW

DTSU666 series and DSSU666 series three phase electronic energy meter	ZTY0.464.1448
User manual	Page 9, Total 21

6		Phase A voltage =220.0V	16		Combined phase power factor PFt=0.500
7		Phase B voltage =220.1V	17		Phase A power factor PFa=1.000
8		Phase C voltage =220.2V	18		Phase B power factor PFb=0.500
9		Phase A current =5.000A	19		Phase C power factor PFc=-0.500
10		Phase B current =5.001A			

NOTE1: The factory default baud rate is 9600bps,n.8.1;The communication address of Modbus protocol is 01 (1 ~ 247), E1 means even check 1 stop bit, O1 means odd check 1 stop bit Two stop bits, N2 means two stop bits without check;

NOTE2: The above interface is used to show the meaning of the display content. Due to the different functions of the instrument, the display symbols will increase or decrease.

NOTE3: When RS485 communicating, the telephone sign will flashes.

## 5.2.Programming function

### 5.2.1.Programming parameter

Table 10 Programming parameter

Parameter	Value range	Instruction
	1~9999	Current ratio, used for setting the input loop current ratio: When the current is connected to the line via the transformer, Ct=the rated current of the primary loop / the rated current of the secondary circuit;

DTSU666 series and DSSU666 series three phase electronic energy meter	ZTY0.464.1448
User manual	Page 10, Total 21

		When the current is directly connected to the line, Ct shall be set as 1.
<i>Pt</i>	0.1~999.9	Voltage ratio, used for setting the voltage ratio of the input loop; When the voltage is connected to the line via the transformer, Pt= the rated voltage of the primary loop / the rated voltage of the secondary circuit; When the voltage is directly connected to the line, Pt shall be set as 1.0.
<i>Prot</i>	1: 645; 2: n.2; 3: n.1; 4: E.1; 5: O.1;	Communication protocol switches: 1: DL/T 645-2007; 2: None parity, 2 stop bits, n.2; 3: None parity, 1 stop bit, n.1; 4: Even parity, 1 stop bit, E.1; 5: Odd parity, 1 stop bit, O.1;
<i>bAud</i>	0: 1200; 1: 2400; 2: 4800; 3: 9600; 4: 19200;	Communication baud rate: 0: Communication baud rate to be 1200bps; 1: Communication baud rate to be 2400bps; 2: Communication baud rate is 4800bps; 3: Communication baud rate is 9600bps; 4: Communication baud rate is 19200bps;
<i>Addr</i>	1~247	Communication address
<i>nEt</i>	0: n.34; 1: n.33;	Option for wiring mode: 0: n.34 represents three phase four wire; 1: n.33 represents three phase three wire.
<i>CLrE</i>	0:n0; 1:E	The setting is 1, representing the allowed instrument energy data clearance, which will be zero reset after clearing.
<i>PLuS</i>	0:P; 1:Q;	Pulse output:



DTSU666 series and DSSU666 series three phase electronic energy meter	ZTY0.464.1448
User manual	Page 12, Total 21

Figure 5 Setting examples for communication address and Baud Rate

### 5.3. Communication function

Characterized with a RS485 communication interface, the baud rate can be changed between 1200bps, 2400bps, 4800bps , 9600bps and 19200. The default baud rate is 9600bps, with the calibration bit and stop bit to be N.1, and instrument address 01 (please see instrument factory number or crystal display screen).

Communication protocol: complied with the requirement of Modbus communication protocol. The following table is the common ModBus protocol address table. ModBus\_RTU protocol read command is 03H, write command is 10H.

Table 11 ModBus protocol address table

Parameter address	Parameter code	Instructions of parameters	Data type	Data length Word	Read Write
Keyboard parameters (specific parameters see the instructions of programming parameters, the actual value with (*) parameter= communication parameter value × 0.1)					
0000H	REV.	Software Version	Signed	1	R
0001H	UCode	Programming code codeE(1~9999)	Signed	1	R/W
0003H	net	Network selection (0:three phase four wire,1:three phase three wire)	Signed	1	R/W
0006H	IrAt	Current transformer rate IrAt(1~9999)	Signed	1	R/W
0007H	UrAt	Voltage transformer rate UrAt (*) (1~9999 represents voltage ratio 0.1~999.9)	Signed	1	R/W
000AH	Disp	Rotating display time (s)	Signed	1	R/W
000BH	B.LCD	Backlight time control (m)	Signed	1	R/W
000CH	Endian	Reserve	Signed	1	R/W
002CH	Protocol	Protocol switching (1:DL/T645;2:n.2;3:n.1;4:E.1;5:o.1)	Signed	1	R/W
002DH	bAud	Communication baud rate bAud (0:1200;1:2400;2:4800;3:9600;4:19200)	Signed	1	R/W
002EH	Addr	Communication address Addr(1~247)	Signed	1	R/W

DTSU666 series and DSSU666 series three phase electronic energy meter	ZTY0.464.1448
User manual	Page 13, Total 21

Electricity data on the secondary side					
2000H	Uab	Three phase line voltage data, Unit V( $\times 0.1V$ )	float	2	R
2002H	Ubc		float	2	R
2004H	Uca		float	2	R
2006H	Ua	Three phase voltage data, Unit V( $\times 0.1V$ ) (Invalid for three phase three wire)	float	2	R
2008H	Ub		float	2	R
200AH	Uc		float	2	R
200CH	Ia	Three phase current data, Unit A( $\times 0.001A$ )	float	2	R
200EH	Ib		float	2	R
2010H	Ic		float	2	R
2012H	Pt	Combined active power, Unit W( $\times 0.1W$ )	float	2	R
2014H	Pa	A phase active power, Unit W( $\times 0.1W$ )	float	2	R
2016H	Pb	B phase active power, Unit W( $\times 0.1W$ ) (Invalid for three phase three wire)	float	2	R
2018H	Pc	C phase active power, Unit W( $\times 0.1W$ )	float	2	R
201AH	Qt	Combined reactive power, Unit var( $\times 0.1var$ )	float	2	R
201CH	Qa	A phase reactive power, Unit var( $\times 0.1var$ )	float	2	R
201EH	Qb	B phase reactive power, Unit var( $\times 0.1var$ ) (Invalid for three phase three wire)	float	2	R
2020H	Qc	C phase reactive power, Unit var( $\times 0.1var$ )	float	2	R
202AH	PFt	Combined power factor(forward number: inductive, reverse number: capacitive) ( $\times 0.001$ )	float	2	R
202CH	PFa	A phase power factor(forward number: inductive, reverse number: capacitive) (Invalid for three phase three wire) ( $\times 0.001$ )	float	2	R
202EH	PFb	B phase power factor(forward number: inductive, reverse number: capacitive) (Invalid for three phase three wire) ( $\times 0.001$ )	float	2	R
2030H	PFc	C phase power factor(forward number: inductive, reverse number: capacitive) (Invalid for three phase three wire) ( $\times 0.001$ )	float	2	R
2044H	Freq	Frequency, Unit Hz( $\times 0.01Hz$ )	float	2	R
Power secondary side data					
101EH	ImpEp	(current) Total Forward active energy(kWh)	float	2	R

DTSU666 series and DSSU666 series three phase electronic energy meter	ZTY0.464.1448
User manual	Page 14, Total 21

1020H	ImpEpA	(current) A Forward active energy(kWh)	float	2	R
1022H	ImpEpB	(current) B Forward active energy(kWh)	float	2	R
1024H	ImpEpC	(current) C Forward active energy(kWh)	float	2	R
1026H	NetImpEp	(current) Net Forward active energy(kWh)	float	2	R
1028H	ExpEp	(current) Total Reverse active energy(kWh)	float	2	R
102AH	ExpEpA	(current) A Reverse active energy(kWh)	float	2	R
102CH	ExpEpB	(current) B Reverse active energy(kWh)	float	2	R
102EH	ExpEpC	(current) C Reverse active energy(kWh)	float	2	R
1030H	NetExpEp	(current) Net Reverse active energy(kWh)	float	2	R

Note 1: When the ratio of the voltage transformer is 1, the data of read voltage transformer ratio register UrAt is 10. When the ratio of voltage transformer is 1, ignore the above table(UrAt×0.1).

Note 2: Single-precision floating point adopts standard IEEE754 format, total 32 bit(4 word). The single-precision floating point mode is assumed to be ABCD(high type in the front, low byte behind).

Note 3: The table only give the regular correspondence address. If you need the primary data address and other addresses, you can call for the detailed communication protocol.

#### 5.4. Energy measurement function

The horizontal axis of the measurement plane represents the current vector I (fixed on the horizontal axis), and the instantaneous voltage vector is used to represent the current power transmission. Compared with the current vector I, it has phase angle  $\phi$ .

The counter-clockwise direction  $\phi$  angle is positive. A schematic diagram of the four-quadrant is shown in Figure 6

DTSU666 series and DSSU666 series three phase electronic energy meter	ZTY0.464.1448
User manual	Page 15, Total 21

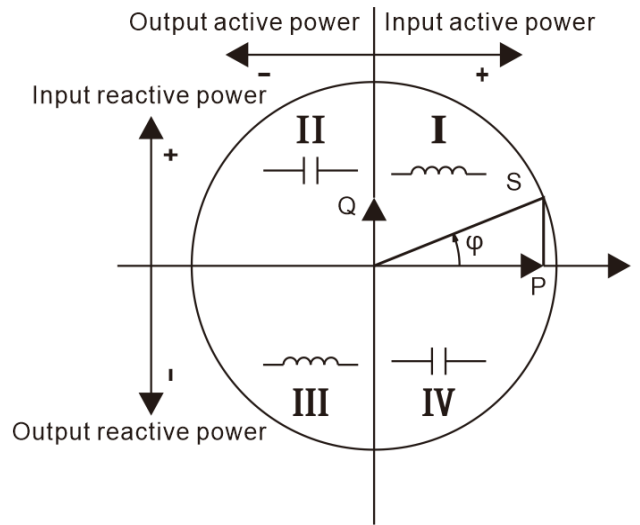

Figure 6 Measurement schematic diagram for energy four quadrants

## 6. Outline and installation size

Table 12 Installation size

Model	modulus	Outline size (length×width×height) mm	Installation size (din rail)	Weight (g)
DTSU666	4	100×72×65.5	DIN35 Standard din rail	440
DSSU666	4			440
DTSU666-CT	4			440

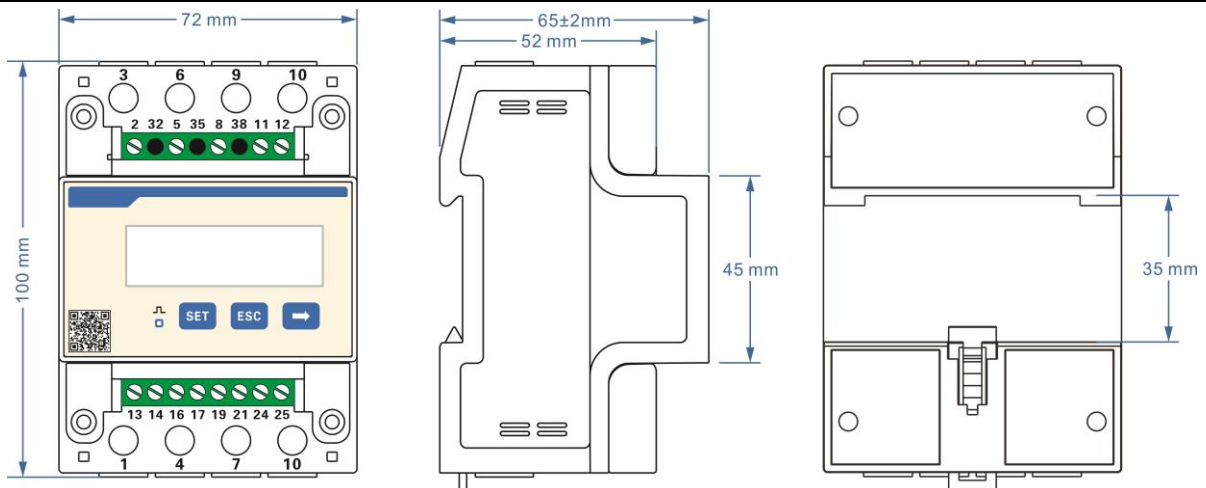

Figure 7 Access via CT Outline size diagram (four modulus)



DTSU666 series and DSSU666 series three phase electronic energy meter	ZTY0.464.1448
User manual	Page 16, Total 21

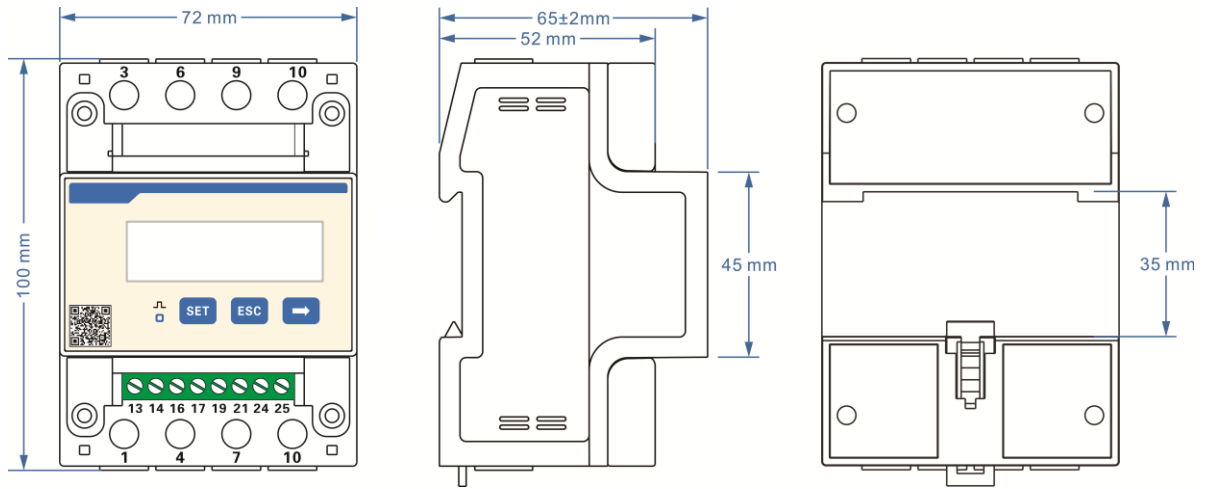

Figure 8 Direct access instrument Outline size diagram (four modulus)

Note 1: The undeclared tolerance is  $\pm 1$  mm;

Note 2: Only indicates the size, and the shape of different specifications is slightly different.

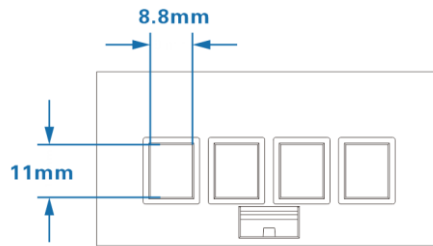

Figure 9 current cable terminal (Conductor Cross-sectional Area Range  $\leq 16$  mm<sup>2</sup>)

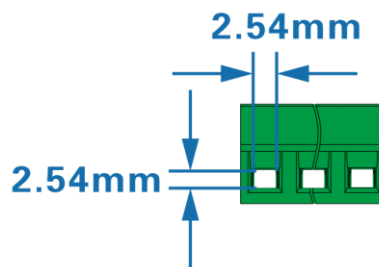

Figure 10 RS485 cable terminal (Conductor Cross-sectional Area Range 0.25-1mm<sup>2</sup>)

## 7. Installation and operation manual

### 7.1. Inspection Tips

When unpacking the carton, if the shell has obvious signs caused by severe impact or falling, please contact with the supplier as soon as possible.

DTSU666 series and DSSU666 series three phase electronic energy meter	ZTY0.464.1448
User manual	Page 17, Total 21

After the instrument being removed from the packing box, it should be placed on a flat and safe plane, facing up, not overlaying for more than five layers. If not installed or used in a short time, the electric meter shall be packed and placed to the original packing box for storage.

### 7.2. Installation and tips

#### 7.2.1. Installation and Inspection

If the model No or configuration in the original packing box is not in accordance with the requirement, please contact with the supplier. While, if the inner package or shell has been damaged after removing the instrument from the packing box, please do not install, power on the instrument, please contact with the supplier as soon as possible, instead.

#### 7.2.2. Installation

It requires experienced electrician or professional personnel to install it and you must read this operation manual. During the installation, if the shell has obvious damage or marks caused by violent impact or falling, please do not install it or power on and contact with the supplier as soon as possible.

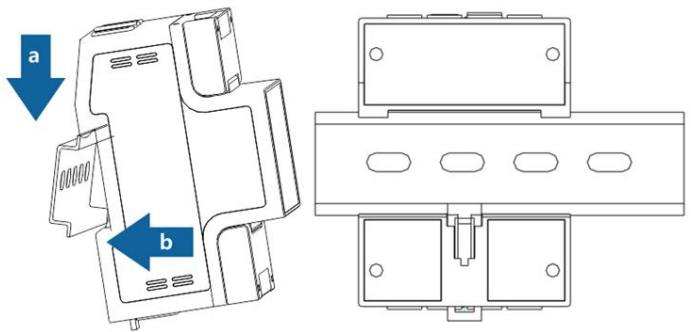
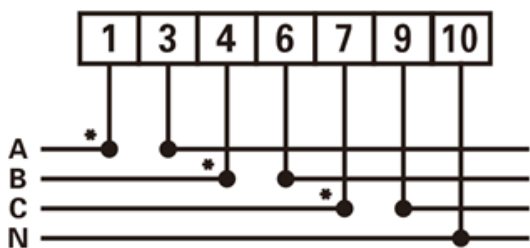
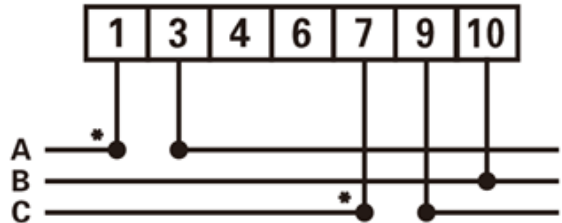

Figure 11 Installation Diagram

### 7.3. Typical wiring



Three phase four wire: direct connect



Three phase three wire: direct connect

DTSU666 series and DSSU666 series three phase electronic energy meter	ZTY0.464.1448
User manual	Page 18, Total 21

Figure 12

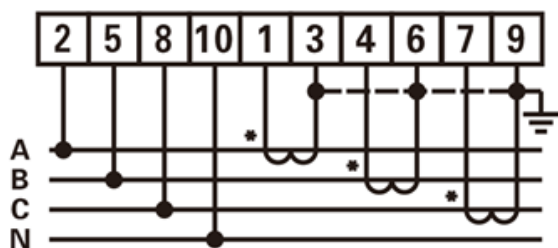

Three phase four wire: via current transformer

Figure 13

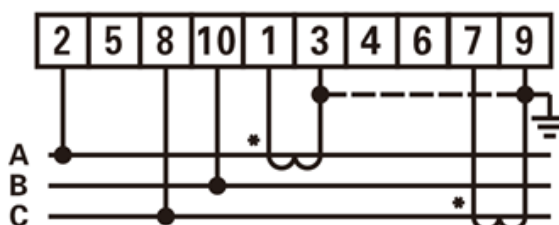

Three phase three wire: via current transformer

Figure 14



RS485

Figure 16

Figure 15

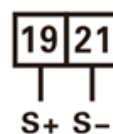

Pulse output

Figure 17

◆ Voltage signal (only for connection via current transformer)

2-----UA (Phase A voltage input terminal)

5 -----UB (Phase B voltage input terminal)

8-----UC (Phase C voltage input terminal)

10-----UN (Phase N voltage input terminal)

◆ Current signal:

1-----IA\*(Phase A current input terminal)

3-----IA (Phase A current output terminal)

4-----IB\*(Phase B current input terminal)

6-----IB (Phase B current output terminal)

7-----IC\*(Phase C current input terminal)

9-----IC(Phase C current output terminal)

◆ RS485 Communication wire

24-----A (RS485 Terminal A)

25-----B (RS485 Terminal B)

◆ Auxiliary function

19----- Active energy and reactive energy output high terminal

21----- Active energy and reactive energy output low terminal

NOTICE:In the Figure 12、13、14、15, the L1、L2、L3 correspond to Phase A、Phase B、Phase C

8.Diagnosis, analysis and elimination for common faults

Fault phenomenon	Reason analysis	Elimination	Notes
------------------	-----------------	-------------	-------

DTSU666 series and DSSU666 series three phase electronic energy meter	ZTY0.464.1448
User manual	Page 19, Total 21

No display when powered on	<ol style="list-style-type: none"> <li>1. Incorrect wiring</li> <li>2. Abnormal voltage for the instrument</li> </ol>	<ol style="list-style-type: none"> <li>1. If it is wrongly connected, please reconnect based on the right wiring mode (see the wiring diagram).</li> <li>2. If the supplied voltage is abnormal, please choose the specified voltage.</li> <li>3. If not the above problems, please contact with the local supplier.</li> </ol>	
Abnormal RS485 communication	<ol style="list-style-type: none"> <li>1. RS485 communication cable is opened, short circuit or reversely connected.</li> <li>2. Address, baud rate, data bit and check bit is not in accordance with the host computer.</li> <li>3. The end of RS485 communication cable has not been matched with resistance (when the distance over than 150 meters)</li> <li>4. Not matched with the communication protocol order of the host computer</li> </ol>	<ol style="list-style-type: none"> <li>1. If there is any problem with the communication cable, please change it.</li> <li>2. Set the address, baud rate, data bit and check bit through buttons and confirm it is the same with the host computer, then set the operation to be “parameter settings”.</li> <li>3. If the communication distance is over than 150 meters, and the communication parameter settings are the same as the host computer, but cannot be communicated, then please lower the baud rate or add a resistance of 120Ω at the start terminal and ending terminal.</li> </ol>	
Abnormal data for the electrical parameter (voltage, current, power, etc.)	<ol style="list-style-type: none"> <li>1. The transformer's ratio hasn't been set, and the instrument displays the secondary side data.</li> </ol>	<ol style="list-style-type: none"> <li>1. If setting the transformer ratio, please set the voltage ratio and current ratio based on “parameter setting”</li> <li>2. If wrongly connected, please</li> </ol>	

DTSU666 series and DSSU666 series three phase electronic energy meter	ZTY0.464.1448
User manual	Page 20, Total 21

	2. Wrong wiring.	connect the voltage and current of phase A, B and C to the wiring terminal of the instrument.	
Abnormal data for the electrical parameter read by communication (voltage, current, power, etc.)	1. Data read by communication is secondary side data, without transformer ratio. 2. Wrong analysis for data frame	1. Multiply the data read by communication with the voltage ratio and current ratio. 2. Analyze the data frame based on the format of the communication protocol, please pay attention to the mode of the big and small end of data.	

#### 9. Transportation & Storage

When transporting and unpacking the products, please confirm they are not severely impacted, transporting and storing based on Transportation, basic environmental conditions and testing methods for instrument and meters of JB/T9329-1999.

The instrument and accessories shall be stored in the dry and ventilated places, to avoid humidity and corrosive gas erosion, with the limited environmental temperature for storage to be  $-40^{\circ}\text{C} \sim +70^{\circ}\text{C}$  and relative humidity not exceeding 85%.

#### 10. Maintenance & Service

We guarantee free reparation and change for the multi-meter if found any unconformity with the standard, under circumstance of that the users fully comply with this instructions and complete seal after delivery within 18 months.

---

DTSU666 series and DSSU666 series three phase electronic energy meter	ZTY0.464.1448
User manual	Page 21, Total 21

Dear clients,

Please assist us: when the product life is end, to protect our environment, please recycle the product or components, while for the materials that cannot be recycled, please also deal with it in a proper way. Really appreciate your cooperation and support.

## DECLARATION

- 1、 The products, services or functions you purchase are all subject to the commercial contract and terms signed with our company. All or part of the products, services or functions described in this manual may not be included in the scope of the products you purchased.
- 2、 Unless otherwise agreed in the contract, the company does not make any express or implied statement or guarantee for the contents of this manual.
- 3、 The information in this manual is subject to change without notice.
- 4、 The company is not responsible for any indirect losses caused by the provision, display or use of this information.

Name of Company: Zhejiang Chint Instrument & Meter Co., Ltd.

Address: Wenzhou Bridge Industrial Zone, Yueqing, Zhejiang, China.

Zip Code: 325603

Telephone: 0577-62877777

Fax: 0577-62891577

Service hotline: 4008177777

Fake Complaint: 0577-62789987

Website: <http://www.chint.com>

Email: [ztyb@chint.com](mailto:ztyb@chint.com)

Date of Issue: Apr., 2022.

No.:ZTY0.464.1448V2