

Products and systems for the connection of electrical panels

2017-2018 Edition



UNI EN-ISO 9001



UNI EN-ISO 14001

WARNING The technical data contained in this catalogue is not binding for Cabur and may be modified without prior warning, simply for reasons of production or improvement and evolution. For this reason, please contact our technical-commercial offices for any relevant confirmation or updates. For more information about our new products, please visit our website: www.cabur.eu/news

The Company

Founded in 1952, Cabur quickly gained the lead position among national manufacturers of terminal blocks for electrical panels, pursuing a policy which focused particularly on installers' needs and offering cutting-edge technological solutions.

With over 65 years of experience, Cabur develops and creates, based on its own designs, a vast array of products for the electro-technical and electronic industries famous for their reliability even under extreme conditions.

Our current production includes:

- terminal blocks and boards for electrical panels
- electronic products for electrical panels
- terminal blocks for civil and industrial installations
- products for photovoltaic systems
- industrial marking systems

In pursuing a corporate culture based on Total Quality, Cabur has adopted the main European directives of the reference market, and collaborates with the most prestigious national and foreign Institutes and Laboratories.

which perfectly meet the various and complex installation needs of users.

Our production, which is wide and diversified, represents the optimal synthesis of Cabur's long experience as a supplier to the main national energy boards and companies, together with activities and collaboration abroad.



Screw-clamp terminal blocks

Feed-through and power terminal blocks	page 2-23
Earth terminal blocks	pages 24-26
Two and three level terminal blocks	pages 27-33
Fuse-holder terminal blocks	pages 34-40
Disconnect terminal blocks	pages 41-44
Terminal blocks for test and measurement circuits	pages 46-47
Diode-holder terminal blocks	page 48
Terminal blocks with electronic components	pages 49-52
Terminal blocks with special connections and for connectors	pages 53-59
Mini-terminal blocks	pages 60 -61
Multi-pole composable terminal boards	page 63-66
Neutral disconnect terminal blocks	page 67

Spring-clamp terminal blocks

Feed-through terminal blocks	pages 70-75
Earth terminal blocks	pages 76-79
Two and three level terminal blocks	pages 80-83
Disconnect terminal blocks	page 84
Fuse-holder terminal blocks	pages 85-86
Terminal blocks for connectors	pages 87-89
Mini-terminal blocks	pages 90 -91

Insulation displacement terminal blocks

Feed-through terminal blocks	page 93
--	---------

Control and distribution terminal boards

Terminal boards for metering panels	pages 94-100
Distribution terminal boards	pages 101-106

Terminal blocks and installation products

Mobile terminal blocks, CONTC Series	page 107
Mobile terminal blocks, CONT Series	page 108
Terminal boards, CAMUT Series	page 111
Screwdrivers, pliers, ferrules	pages 112-113

Accessories

.	pages 115-151
-----------	---------------

Iconographic index

Screw-clamp terminal blocks

Feed-through terminal blocks, CBC Series



High current terminal blocks, GPA Series

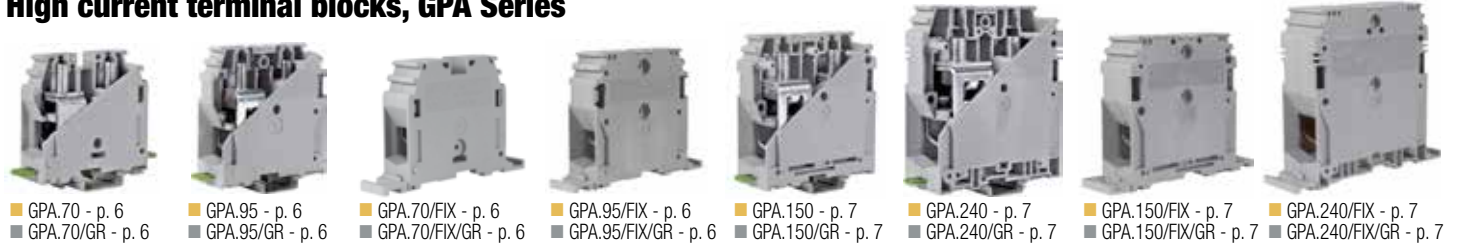

Earth terminal blocks, TEC Series



Feed-through terminal blocks, CBD Series



High current terminal blocks, GPM Series

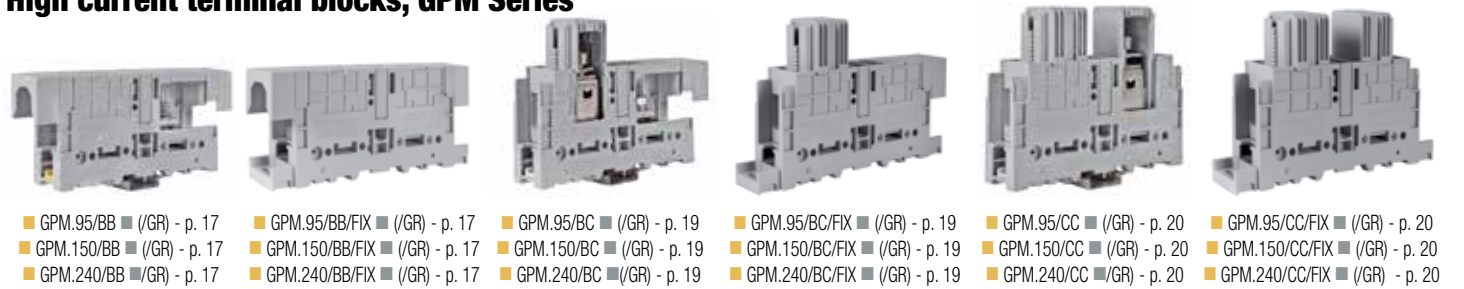

ACB Series



MBL Series



Earth terminal blocks



Earth terminal blocks

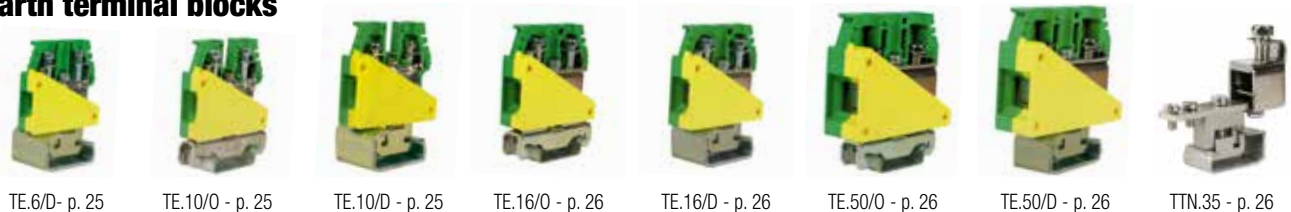

Two and three level terminal blocks

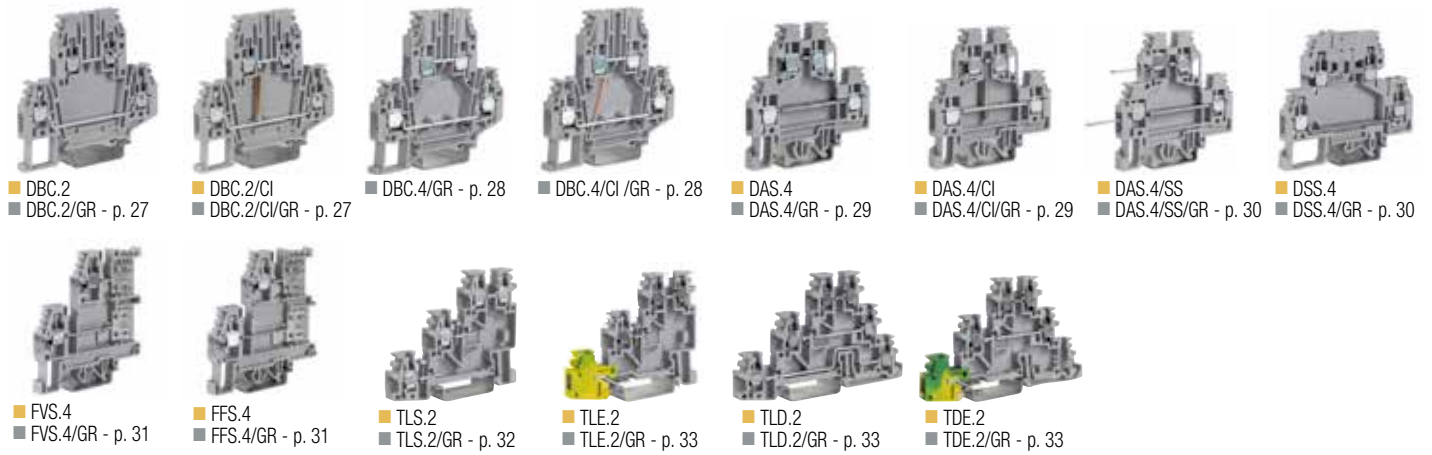

Fuse-holder terminal blocks

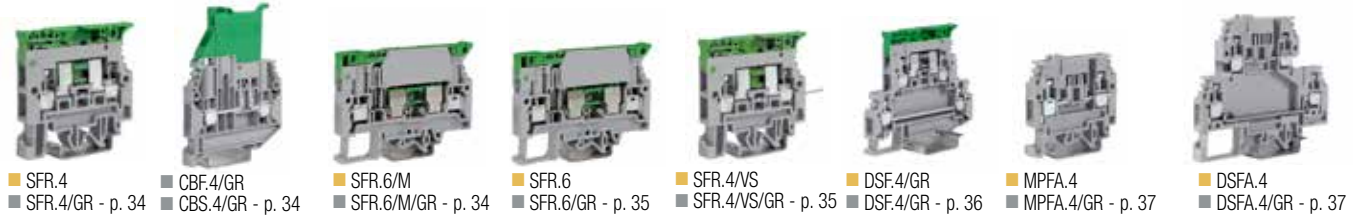

Disconnect terminal blocks

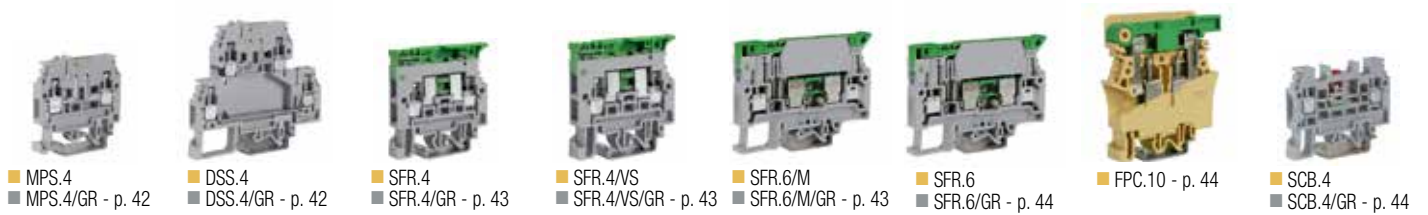

Terminal blocks for test and measurement circuits

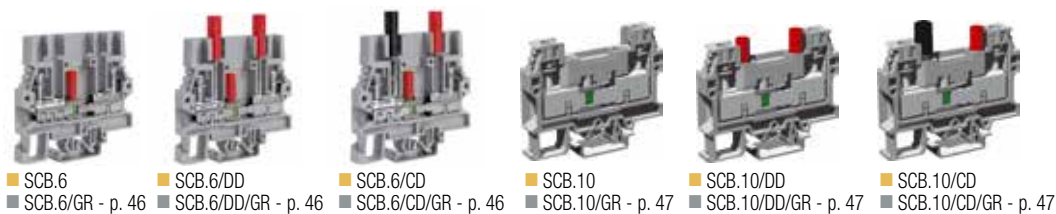

Diode-holder terminal blocks

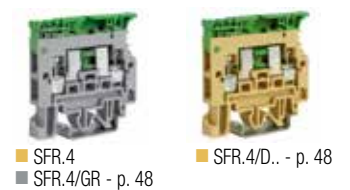

Iconographic index

Terminal blocks with electronic components

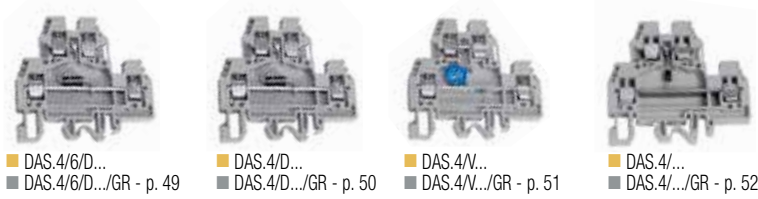

Terminal blocks with special connections and for connectors

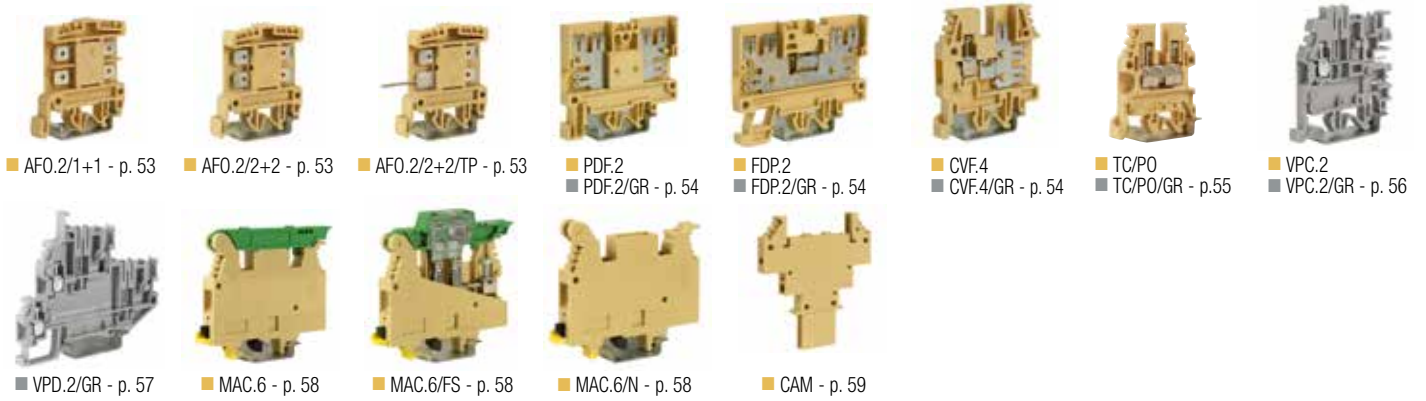

Mini terminal blocks



Modular multi-pole terminal blocks



Modular multi-pole terminal blocks



Multi-pole rail assemblies with special connections

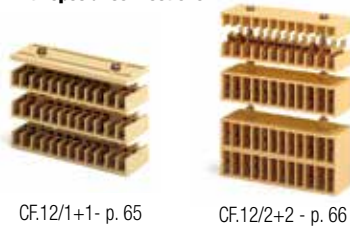

Neutral disconnect terminal blocks



Spring-clamp terminal blocks

Feed-through terminal blocks



Disconnect terminal blocks



Feed-through terminal blocks



Earth terminal blocks



HTE.1 - p. 76 HTE.1/1+2 - p. 76 HTE.1/2+2 - p. 76 HTE.2 - p. 77 HTE.2/1+2 - p. 77 HTE.2/2+2 - p. 77 HTE.4 - p. 78 HTE.4/1+2 - p. 78 HTE.4/2+2 - p. 78

Two and three level terminal blocks

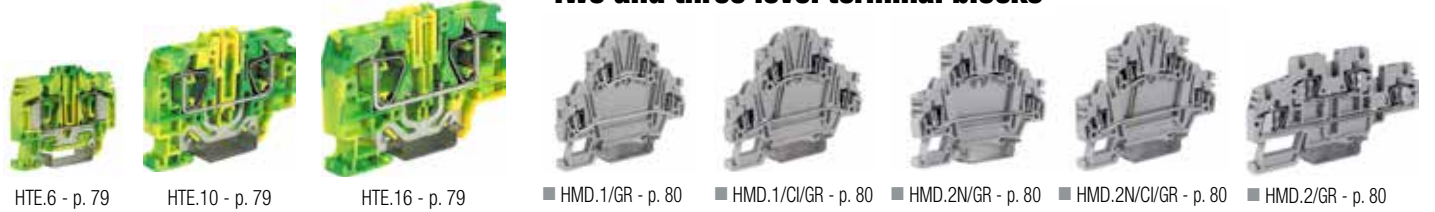

HTE.6 - p. 79 HTE.10 - p. 79 HTE.16 - p. 79 HMD.1/GR - p. 80 HMD.1/CI/GR - p. 80 HMD.2N/GR - p. 80 HMD.2N/CI/GR - p. 80 HMD.2/GR - p. 80



HMD.1/X/GR - p. 81 HMD.2N/X/GR - p. 81 HMD.2N/X1/GR - p. 82 HLD.2/GR - p. 83 HDE.2/GR - p. 83 HTTE.2 - p. 83

Switchable terminal blocks

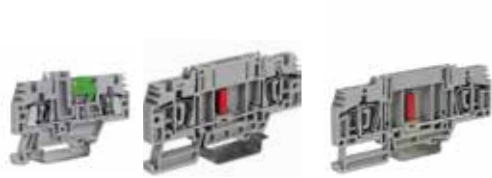

HMS.2/GR - p. 84 HSCB.4/GR - p. 84 HSCB.6/GR - p. 84

Fuse-holder terminal blocks



HMFA.2/GR - p. 85 HFR.4/M/GR - p. 86 HFR.4/GR - p. 86

Terminal blocks for connectors



HCD.1/GR - p. 87 HVPC.2/GR - p. 88 CHP.2(D)/GR - p. 88

Mini terminal blocks



HVTE.2 - p. 89 CHTE.2(D)/GR - p. 89 HPP.2/GR - p. 90 HP.2/GR - p. 90 HPC.2/GR - p. 91

Feed through insulation displacement terminal blocks



NCS - p. 93 NCV - p. 93

Terminal blocks for measurement circuits



from p. 94 to p. 100

Distribution terminal boards QBOLK - QPOL



from p. 101 to p. 106

Mobile terminal boards CONTC - CONT



from p. 107 to p. 110

12-pole terminal boards CAMUT



to p. 111

Feed-through and high-current terminal blocks

CBC Series.....	pages 2-4
CBR.2	page 5
GPA Series.....	pages 6-7
TEC Series.....	pages 8-9
CBD Series.....	pages 10-15
GPM Series.....	pages 16-20
ABC Series.....	page 21
MBL Series.....	pages 22-23

Earth terminal blocks

TEO Series.....	page 24
CBE.2	page 24
TED.4	page 25
TE/O Series.....	pages 25-26
TTN.35	page 26

Two and three level terminal blocks

DBC.2 - DBC.2/Cl.....	page 27
DBC.4 - DBC.4/Cl.....	page 28
DAS.4 - DAS.4/Cl.....	page 29
DAS.4/SS - DSS.4	page 30
FVS.4 – FFS.4	page 31
TLS.2.....	page 32
TLE.2 - TLD.2 - TDE.2	page 33

Fuse-holder terminal blocks

SFR.4 - CBF.4 - SFR.6/M	page 34
SFR.6 - SFR.4/VS - SFO.4/VS	page 35
DSF.4/GR	page 36
MPFA.4 - DSFA.4.....	page 37
CPF/5 component-holder cartridge	page 38
FPC.10 - FPL.10/C - FPL.10/L	page 39
SFR.4/C - FLP.10/C.....	page 40

Disconnect terminal blocks

CBS.2 - CBS.4	page 41
MPS.4 - DDS.4	page 42
SFR.4 - SFR.4/VS - SFR.6/M.....	page 43
SFR.6 - FPC.10 - SCB.4	page 44

Terminal blocks for test and measurement circuits

SCB.6 Series -	page 46
SCB.10 Series	page 47

Diode-holder terminal blocks

SFR.4 - SFR.4/D.....	page 48
----------------------	---------

Terminal blocks with electronic components

DAS.4/6/D Series.....	page 49
DAS.4/D Series.....	page 50
DAS.4/V Series.....	page 51
DAS.4 Series.....	page 52

Terminal blocks with special connections and for connectors

AFO.2/1+1 - AFO.2/2+2 - AFO.2/2+2/TP	page 53
PDF.2 - FDP.2 - CVF.4.....	page 54
TC/PO	page 55
VPC.2	page 56
VPD.2	page 57
MAC - CAM System	pages 58-59

Mini-terminal blocks

RN.1 - RN.2 - RP.4.....	page 60
RFI.2 - TR.2 - TR.4.....	page 61

Multi-pole modular terminal boards

BPL – TPL Series	pages 63-64
CF.12 Series.....	pages 65-66

Neutral disconnect terminal blocks

CNT Series.....	page 67
-----------------	---------

CBC Series

- reduced overall dimensions
- double possibility of inserting multi-pole PTC cross connections, with no need for additional insulating covers, thanks to the patented "Easy Bridge" (PTC) system and to the new "Easy Bridge Plus" (PTP)
- mounting on PR/3 rails according IEC 60715, TH/35 type
- available in grey and blue For other available colours refer to the single versions
- nominal voltage 1000 V
- certificate **CESI 08 ATEX 061 U EX e** I M2 / II 2 G D
temperature range of use: -40 – +80°C
- **CoC IEC Ex CES 09.0002U** Ex e II
- maximum continual operating temperature 100°C



Easy Bridge System

The Cross connection can be supplied in "standard" size, for 2-3-5-10 poles, or in 250-mm-long bars.

The careful design ensures that the terminal blocks of different sections guarantee visual uniformity in creating the terminal board.



1

2

3

4

5

1-2 After cutting the bar for the number of poles necessary, insert the cross connection in the special cavity of the terminal block. At this point working with the tip of a screwdriver, push the cross connection up to the locking point. The cross connection will be completely isolated and intrinsically IPXXB protected.

3-4 After inserting the cross connection, the poles connected can be highlighted with the aid of the green insert, PTC/SP. This accessory is supplied in the standard length of 100 mm and can easily be sliced with the aid of a simple cutter.

5 To remove the cross connection it is sufficient to remove the PTC/SP insert, insert the tip of the screwdriver in the slot of the cross connection itself, lever it and pull it out.

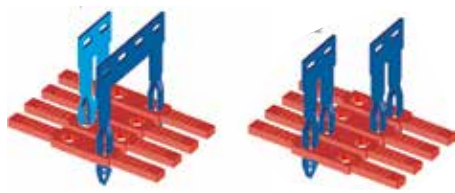

The "Easy Bridge" connection system guarantees the widest possibility of transversal connection, including offset.

Multi-pole CBC.2 cross-connection 2 pole CBC.2 cross-connection

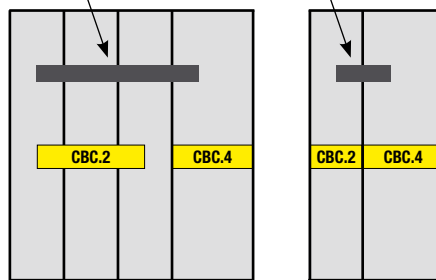

The cross connections can also be used to connect in parallel terminal blocks of the same section with the first of the following unit with a different section.

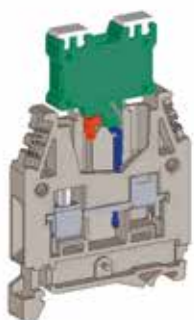

SDC
mounted

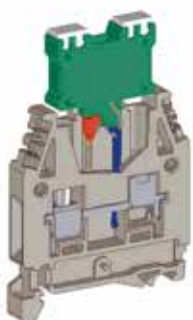
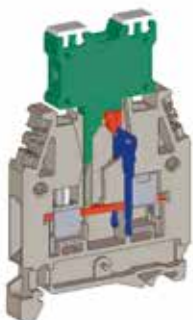

SDC/P
mounted



SDC - SDC/P
with conductors

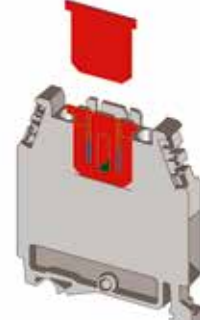

DFM/900

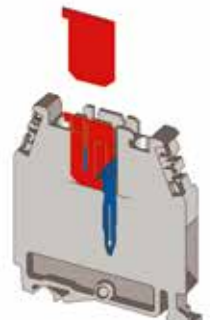

DFM/800

CBC Series

- insulating body UL94V-0
- reduced overall dimensions
- double possibility of inserting multi-pole PTC cross connections, with no need for additional insulating covers, thanks to the patented "Easy Bridge" (PTC) system and to the new "Easy Bridge Plus" (PTP)
- mounting on PR/3 rails according IEC 60715, TH/35 type
- available in grey and blue For other available colours refer to the single versions
- nominal voltage 1000 V
- certificate **CESI 08 ATEX 061 U Ex e** I M2 / II 2 G D temperature range of use: -40 – +80°C
- **CoC IEC Ex CES 09.0002U Ex e II**
- maximum continual operating temperature 100°C



(*): 24 A factory wiring only
(**): 32 A factory wiring only

The suffix **/GR** identifies the grey version.
The figures in brackets refer to Ex e application.

For the isolation values with cross connections refer to the table on page 131

grey version
(Ex)i version

TECHNICAL CHARACTERISTICS

function/type	
rated cross-section	(mm ²)
connecting capacity	
flexible	(mm ²)
rigid	(mm ²)
max. flexible with ferrule (mm ²) - ferrule type	
rated voltage / rated current / gauge	conf. to IEC 60947-7-1
rated voltage / rated current / AWG / tightening torque value	UL
max current (*)	
(Ex e) rated voltage	/ (V)
rated impulse withstand voltage / pollution degree	
insulation stripping length	(mm)
tightening torque value (test / max)	(Nm)
height / width / thickness	7.5 mm
height / width / thickness	15 mm

APPROVALS

ACCESSORIES

End sections	grey blue
"Easy Bridge" (PTC) cross connection (intrinsically IPXXB protected once mounted)	
Available also in coloured version (PTP)	
Ref. p. 130	
Rated current carrying capacity of jumper (same, Ex e version)	(A)
Green	PTC
Switchable cross connection	
Multiple common bar	250 mm
Shunting screw and sleeve	-
Coloured partition	red
Cross connection barrier	red
Test plug socket	-
Test plug	
Modular test plug	
End section for modular test plug	
Numbering strip	
Warning plate	on adjacent terminal blocks
Cover for cross-connection	
Marking tag	printed or blank
End bracket	

CBC.2/GR	Cat. No. CBC02GR
CBC.2 (Ex)i	Cat. No. CBI02

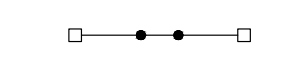

feed-through	2.5
	0.2 – 4
	0.2 – 4
	2.5 - WP25/14
	1000 V / 32 A (4 mm ²) / A3
	600 V / 20 A (*) / 20-12 AWG / 0.4 Nm
	27 A (2.5 mm ²) / 37 A (4 mm ²)
	500
	12 KV / 3
	9
	0.4 / 0.8
	52 / 44 / 5
	60 / 44 / 5



Type	Cat. No.
CBC.2-10/PT/GR	CB061GR
CBC.2-10/PT (Ex)i	CBI061
PTC/2/02 poles	PTC0202
PTC/2/03 poles	PTC0203
PTC/2/05 poles	PTC0205
PTC/2/10 poles	PTC0210
PTC/2/00 (50 poles)	PTC0200
24 / (21)	
PTC/SP	PTC0990
-	-
DFU/4/R	DU04R
DFM/800 - DFM/900	DF800-900
-	-
SDC/5 - SDC/5P	DC005-DC05P
SDC/POL	DCPOL
-	-
CNU/8/51	NU0851
PRP/7/G (100 mm)	PRP070G
-	-
CNU/8/51	NU0851
BTU for PR/DIN and PR/3	BT005
BTO for PR/3 only	BT007
BT/3 for PR/3 only	BT003

CBC.4/GR	Cat. No. CBC04GR
CBC.4 (Ex)i	Cat. No. CBI04

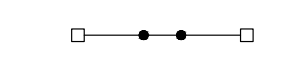

feed-through	4
	0.2 – 6
	0.2 – 6
	4 - WP40/16
	1000 V / 41 A (6 mm ²) / A4
	600 V / 30 A (**) / 20-10 AWG / 0.5 Nm
	38 A (4 mm ²) / 45 A (6 mm ²)
	500
	12 KV / 3
	10
	0.5 / 1.2
	52 / 44 / 6
	60 / 44 / 6

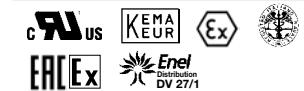

Type	Cat. No.
CBC.2-10/PT/GR	CB061GR
CBC.2-10/PT (Ex)i	CBI061
PTC/4/02 poles	PTC0402
PTC/4/03 poles	PTC0403
PTC/4/05 poles	PTC0405
PTC/4/10 poles	PTC0410
PTC/4/00 (42 poles)	PTC0400
32 / (25)	
PTC/SP	PTC0990
-	-
DFU/4/R	DU04R
DFM/800 - DFM/900	DF800-900
-	-
SDC/6 - SDC/6P	DC006-DC06P
SDC/POL	DCPOL
-	-
CNU/8/61	NU0861
PRP/7/G (100 mm)	PRP070G
-	-
CNU/8/61	NU0861
BTU for PR/DIN and PR/3	BT005
BTO for PR/3 only	BT007
BT/3 for PR/3 only	BT003

CBC.6/GR	Cat. No. CBC06GR
CBC.6 (Ex)i	Cat. No. CBI06

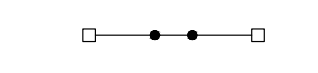

feed-through	6
	0.2 – 10
	0.2 – 10
	6 - WP60/20
	1000 V / 57 A (10 mm ²) / A5
	600 V / 50 A / 20-8 AWG / 1.7 Nm
	53 A (6 mm ²) / 64 A (10 mm ²)
	500
	8 KV / 3
	10
	0.8 / 1.4
	52 / 44 / 8
	60 / 44 / 8



Type	Cat. No.
CBC.2-10/PT/GR	CB061GR
CBC.2-10/PT (Ex)i	CBI061
PTC/6/02 poles	PTC0602
PTC/6/03 poles	PTC0603
PTC/6/05 poles	PTC0605
PTC/6/10 poles	PTC0610
PTC/6/00 (31 poles)	PTC0600
41 / (35)	
PTC/SP	PTC0990
-	-
DFU/4/R	DU04R
DFM/800 - DFM/900	DF800-900
-	-
SDC/6 - SDC/6P	DC006-DC06P
SDC/POL	DCPOL
-	-
CNU/8/51	NU0851
PRP/7/G (100 mm)	PRP070G
-	-
CNU/8/51	NU0851
BTU for PR/DIN and PR/3	BT005
BTO for PR/3 only	BT007
BT/3 for PR/3 only	BT003

PTP Easy Bridge Plus are available also in blue.

CBC Series

- UL94V-0
- reduced overall dimensions
- patented "Easy Bridge" system: double possibility of insertion of multi-pole PTC cross connections, with no need for additional insulating covers
- mounting on PR/3 rails according IEC 60715, TH/35 type
- available in grey and blue
- nominal voltage 1000 V
- certificate **CESI 08 ATEX 061 U Ex e** I M2 / II 2 G D
temperature range of use: -40 – +80°C
- **CoC IEC Ex CES 09.0002U Ex e II**
- maximum continual operating temperature 100°C



The suffix **/GR** identifies the grey version.
The figures in brackets refer to Ex e application.

For the isolation figures with cross connections refer to the table on page 131

grey version
(Ex)i version

TECHNICAL CHARACTERISTICS

function/type	
rated cross-section	(mm²)
connecting capacity	
flexible	(mm²)
rigid	(mm²)
max. flexible with ferrule (mm²) - ferrule type	
rated voltage / rated current / gauge	conf. to IEC 60947-7-1
rated voltage / rated current / AWG / tightening torque value	UL
max current (*)	
(Ex e) rated voltage /	(V)
rated impulse withstand voltage / pollution degree	
insulation stripping length	(mm)
tightening torque value (test / max)	(Nm)
height / width / thickness	TH/35 7.5 mm
height / width / thickness	TH/35 15 mm

APPROVALS

ACCESSORIES

End sections	grey blue
Permanent cross connection (*): intrinsically IPXXB protected once mounted	
Rated current carrying capacity of jumper (same, Ex e version)	(A)
Cross-connection identification strip(100 mm)	green
Switchable cross connection	
Multiple common bar	250 mm
Shunting screw and sleeve (same, Ex e version)	
Coloured partition	red
Cross connection barrier	red
Test plug socket	
Test plug	
Modular test plug	
End section for modular test plug	
Numbering strip	
Warning plate	on adjacent terminal blocks
Cover for cross-connection	
Marking tag	printed or blank
End bracket	

CBC.10/GR	Cat. No. CBC10GR
CBC.10 (Ex)i	Cat. No. CBI10



feed-through	10
flexible	1.5 – 16
rigid	1.5 – 16
max. flexible with ferrule (mm²) - ferrule type	10 - WP100/21
rated voltage / rated current / gauge	1000 V / 76 A (16 mm²) / B6
rated voltage / rated current / AWG / tightening torque value	600 V / 65 A / 14-6 AWG / 1.9 Nm
max current (*)	70 A (10 mm²) / 85 A (16 mm²)
(Ex e) rated voltage /	400
rated impulse withstand voltage / pollution degree	8 kV / 3
insulation stripping length	12
tightening torque value (test / max)	1.2 / 1.9
height / width / thickness	52 / 44 / 10
height / width / thickness	60 / 44 / 10



Type	Cat. No.
CBC.2-10/PT/GR	CB061GR
CBC.2-10/PT (Ex)i	CBI061
PTC/10/02 poles (*)	PTC1002
PTC/10/03 poles (*)	PTC1003
PTC/10/05 poles (*)	PTC1005
PTC/10/10 poles (*)	PTC1010
PTC/10/00 (25 poles) (*)	PTC1000
57 / (47)	
PTC/SP	PTC0990
-	-
-	-
DFU/4/R	DU04R
DFM/800 - DFM/900	DF800-900
-	-
-	-
PRP/7/G (100 mm)	PRP070G
-	-
CNU/8/51	NU0851
BTU for PR/DIN and PR/3	BT005
BTO for PR/3 only	BT007
BT/3 for PR/3 only	BT003

CBC.16/GR	Cat. No. CBC16GR
CBC.16 (Ex)i	Cat. No. CBI16



feed-through	16
flexible	1.5 – 25
rigid	1.5 – 25
max. flexible with ferrule (mm²) - ferrule type	16 - WP160/22
rated voltage / rated current / gauge	1000 V / 101 A (25 mm²) / B7
rated voltage / rated current / AWG / tightening torque value	600 V / 100 A / 16-3 AWG / 2.8 Nm
max current (*)	95 A (16 mm²) / 114 A (25 mm²)
(Ex e) rated voltage /	500
rated impulse withstand voltage / pollution degree	12 kV / 3
insulation stripping length	15
tightening torque value (test / max)	2 / 3
height / width / thickness	56 / 47 / 12
height / width / thickness	64 / 47 / 12



Type	Cat. No.
CBC.16/PT/GR	CB161GR
CBC.16/PT (Ex)i	CBI161
POF/53	POF53
(PFX/53)	(PFX53)
(same, Ex e version)	
76 / (76)	
-	-
POS/53	POS53
PMP/05 21 poles	PMP05
CPM/53 (CPX/53)	CPM53 (CPX53)
DFU/4/R	DU04R
DFM/700	DF700
PSD/B	PD002
SDD/2	DD002
-	-
-	-
TUM/16 on 3 and 4	TUM16
-	-
PRP/7	PRP07
CNU/8/51	NU0851
BTU for PR/DIN and PR/3	BT005
BTO for PR/3 only	BT007
BT/3 for PR/3 only	BT003

CBC.35/GR	Cat. No. CBC35GR
CBC.35 (Ex)i	Cat. No. CBI35



feed-through	35
flexible	2.5 – 50
rigid	2.5 – 50
max. flexible with ferrule (mm²) - ferrule type	35 - WP350/30
rated voltage / rated current / gauge	1000 V / 150 A (50 mm²) / B9
rated voltage / rated current / AWG / tightening torque value	600 V / 125 A / 20-1 AWG / 8.47 Nm
max current (*)	134 A (35 mm²) / 160 A (50 mm²)
(Ex e) rated voltage /	630
rated impulse withstand voltage / pollution degree	12 kV / 3
insulation stripping length	18
tightening torque value (test / max)	2.5 / 5
height / width / thickness	63 / 56 / 16
height / width / thickness	71 / 56 / 16



Type	Cat. No.
CBC.35/PT/GR	CB351GR
CBC.35/PT (Ex)i	CBI351
POF/35	POF35
PFX/35	(PFX35)
(same, Ex e version)	
125 / (125)	
-	-
-	-
PMP/35 16 poles	PMP35
CPM/35 (CPX/35)	CPM35 (CPX35)
DFU/5/R	DU05R
DFM/700	DF700
PSD/B	PD002
SDD/2	DD002
-	-
-	-
TUM/06 on 3 and 4	TUM06
-	-
PRP/8	PRP08
CNU/8/51	NU0851
BTU for PR/DIN and PR/3	BT005
BTO for PR/3 only	BT007
BT/3 for PR/3 only	BT003

CBR Series

- UL94V-0
- reduced overall dimensions
- universal mounting for both PR/DIN and PR/3 rails which meet IEC 60715 norms, "G32" and TH/35 types
- available in grey and beige
- maximum continual operating temperature 100°C



The tag **/GR** identifies the grey version.

grey version
beige version
(Ex)i version

CBR.2/GR	Cat. No. CR110GR
CBR.2	Cat. No. CR110
CBR.2(Ex)i	Cat. No. CI110

TECHNICAL CHARACTERISTICS

function/type	
rated cross-section	(mm ²)
connecting capacity	
flexible	(mm ²)
rigid	(mm ²)
max. flexible with ferrule (mm ²) - ferrule type	
rated voltage / rated current / gauge	conf. to IEC 60947-7-1
rated voltage / rated current / AWG / tightening torque value	UL
(Ex e) rated voltage	(V)
rated impulse withstand voltage / pollution degree	
insulation stripping length	(mm)
tightening torque value (test / max)	(Nm)
height / width / thickness	TH/35 7,5 mm
height / width / thickness	TH/35 15 mm
height / width / thickness	G32

□-□-●-□-□
distributor feed-through (2 inputs / 2 outputs)
2.5
0.2 – 4
0.2 – 4
2.5 - WP25/14
800 V / 24 A / A3
600 V / 15 A / 20-14 AWG / 5.5 lb.in
-
8 KV / 3
8
0.4 / 0.5
52 / 43 / 5
60 / 43 / 5
56 / 43 / 5

APPROVALS



ACCESSORIES

End sections	grey beige blue
Permanent cross connection	
Rated current carrying capacity of jumper	(A)
Jumper identification strip (100 mm)	
Switchable cross connection	
Multiple common bar	250 mm
Shunting screw and sleeve	
Coloured partition	red, green, white
Cross connection barrier	red
Test plug socket	
Test plug	
Modular test plug	
End section for modular test plug	
Numbering strip	
Warning plate	on adjacent terminal blocks
Cover for cross-connection	
Marking tag	printed or blank
End bracket	

Type	Cat. No.
CBR/PT/GR	CR111GR
CBR/PT	CR111
PM/25/2 poles	PM252
PM/25/3 poles	PM253
PM/25/5 poles	PM255
PM/25/10 poles	PM250
24	
-	PRP05
-	
PMP/25	PMP25
CPM/25 50 poles	CPM25
DFU/4/R	DU04R
-	
PSD/K	PD011
SDD/1	DD001
-	
-	
-	
-	
PRP/5	PRP05
CNU/8/51	NU0851
BTU for PR/DIN and PR/3	BT005
BTO for PR/3 only	BT007
BT/3 for PR/3 only	BT003
BT/DIN/PO	BT001

GPA Series power terminal blocks

with UL94V-0 polyamide insulating body

- mounting for both PR/DIN and PR/3 rails which meet IEC 60715 norms, "G32" and TH/35 types
- panel mount version - M6 screws (recommended with screwdriver and washer slot)
- interlockable with standard M3-type threaded stay bolts
- possible to create parallel connections (GPA.70)
- nominal voltage 1000 V
- maximum continual operating temperature 100°C



version suitable for use in (Ex)i "intrinsic safety" circuits (RAL 5015 blue colour)

GPA.70 (Ex)i code **GA410**
GPA.95 (Ex)i code **GA110**

The suffix /GR identifies the grey version.

grey version
beige version
grey panel-mount version
beige panel-mount version

GPA.70/GR	Cat. No. GA400GR
GPA.70	Cat. No. GA400
GPA.70/FIX/GR	Cat. No. GF400GR
GPA.70/FIX	Cat. No. GF400

GPA.95/GR	Cat. No. GA100GR
GPA.95	Cat. No. GA100
GPA.95/FIX/GR	Cat. No. GF100GR
GPA.95/FIX	Cat. No. GF100

TECHNICAL CHARACTERISTICS	
function/type	
rated cross-section	(mm ²)
connecting capacity	
flexible	(mm ²)
rigid	(mm ²)
bars and/or cable lugs	
rated voltage / rated current / gauge	conf. to IEC 60947-7-1
rated voltage / rated current / AWG / tightening torque value	UL
rated impulse withstand voltage / pollution degree	
insulation stripping length	(mm)
tightening torque value - bar (test / recommended)	(Nm)
tightening torque value - cable (test / recommended)	(Nm)
height / width / thickness	TH/35 7.5 mm
height / width / thickness	TH/35 15 mm
height / width / thickness	G32
height / width (fixing distance between centres) / thickness (panel mount)	

□ — ● — □	feed-through
	70
	10 – 95
	10 – 95
	-
	1000 V / 192 A / B11
	600 V / 215 A / 8 AWG str. – 4/0 AWG str. / 79.5 lb.in
	12 KV / 3
	25
	-
	6 / 9 (Allen screw, 4 mm wrench)
	70 / 91 / 20.5
	78 / 91 / 20.5
	75 / 91 / 20.5
	75 / 102 (88) / 20.5

□ — □	feed-through
	95
	10 – 95
	10 – 120
	-
	1000 V / 232 A / B12
	600 V / 232 A / 2 AWG sol./str. – 250 MCM str./90 lb.in.
	12 KV / 3
	30
	-
	6 / 9 (Allen screw, 4 mm wrench)
	87 / 98 / 26
	95 / 98 / 26
	91 / 98 / 26
	91 / 111 (97) / 26

APPROVALS



ACCESSORIES	
End sections	grey beige
Permanent cross connection	
Rated current carrying capacity of jumper	(A)
Multiple common bar	250 mm
Shunting screw and sleeve	
Coloured partition	red, green, white
Cross connection barrier	red
Test plug socket	
Test plug	
Numbering strip	
Cover for cross-connection	
Mounting rail support	flat for PR/DIN and PR/3 sloped for PR/DIN and PR/3
Marking tag	printed or blank
End bracket	

Type	Cat. No.
-	-
POF/70 (2 poles)	POF70
192	
PMP/08	PMP08
CPM/70 12 poles	CPM70
DF/GPA/70	DU070
-	-
PSD/C	PD003
SDD/2	DD002
-	-
PRP/08	PRP08
ACI121213	Z121213
ACI121024	Z121024
CNU/8/51	NU0851
-	-
BTU for PR/DIN and PR/3	BT005
CDA/BT for PR/DIN only	CD003
BT/3-BTO for PR/3 only	BT003-BT007

Type	Cat. No.
-	-
-	-
-	-
-	-
-	-
-	-
-	-
-	-
-	-
ACI121213	Z121213
ACI121024	Z121024
CNU/8/51	NU0851
-	-
BTU for PR/DIN and PR/3	BT005
CDA/BT for PR/DIN only	CD003
BT/3-BTO for PR/3 only	BT003-BT007

GPA Series power terminal blocks

with UL94V-0 polyamide insulating body

- mounting for both PR/DIN and PR/3 rails which meet IEC 60715 norms, "G32" and TH/35 types
- panel mount version - M6 screws (recommended with screwdriver and washer slot)
- nominal voltage 1000 V
- possibility of compacting the terminal blocks using M3 threaded stay bolts
- maximum continual operating temperature 100°C



grey version
beige version
grey panel-mount version
beige panel-mount version

TECHNICAL CHARACTERISTICS

function/type	
rated cross-section (mm ²)	
connecting capacity	
flexible (mm ²)	
rigid (mm ²)	
bars and/or cable lugs	
rated voltage / rated current / gauge conf. to IEC 60947-7-1	
rated voltage / rated current / AWG / tightening torque value UL	
rated impulse withstand voltage / pollution degree	
insulation stripping length (mm)	
tightening torque value - bar (test / recommended) (Nm)	
tightening torque value - cable (test / recommended) (Nm)	
height / width / thickness — TH/35 7.5 mm	
height / width / thickness — TH/35 15 mm	
height / width / thickness — G32	
height / width (fixing distance between centres) / thickness (panel mount)	

GPA.150/GR Cat. No. GA200GR
GPA.150 Cat. No. GA200
GPA.150/FX/GR Cat. No. GF200GR
GPA.150/FIX Cat. No. GF200

GPA.240/GR Cat. No. GA300GR
GPA.240 Cat. No. GA300
GPA.240/FIX/GR Cat. No. GF300GR
GPA.240/FIX Cat. No. GF300

feed-through	150
connecting capacity	50 – 150 50 – 185
bars and/or cable lugs	-
rated voltage / rated current / gauge	1000 V / 309 A / B14
rated voltage / rated current / AWG / tightening torque value UL	600 V / 309 A / 1/0 AWG str. – 350 MCM str. / 142 lb.in 12 KV / 3
rated impulse withstand voltage / pollution degree	12 KV / 3
insulation stripping length (mm)	35
tightening torque value - bar (test / recommended) (Nm)	-
tightening torque value - cable (test / recommended) (Nm)	10 / 15 (Allen screw, 5 mm wrench)
height / width / thickness — TH/35 7.5 mm	99 / 108 / 31
height / width / thickness — TH/35 15 mm	106 / 108 / 31
height / width / thickness — G32	103 / 108 / 31
height / width (fixing distance between centres) / thickness (panel mount)	94 / 122 (106) / 31

feed-through	240
connecting capacity	95 – 240 50 – 300
bars and/or cable lugs	-
rated voltage / rated current / gauge	1000 V / 415 A / B16
rated voltage / rated current / AWG / tightening torque value UL	600 V / 415 A / 3/0 AWG str. – 600 MCM str. / 300 lb.in 12 KV / 3
rated impulse withstand voltage / pollution degree	12 KV / 3
insulation stripping length (mm)	40
tightening torque value - bar (test / recommended) (Nm)	-
tightening torque value - cable (test / recommended) (Nm)	14 / 21 (Allen screw, 6 mm wrench)
height / width / thickness — TH/35 7.5 mm	120 / 119 / 37
height / width / thickness — TH/35 15 mm	128 / 119 / 37
height / width / thickness — G32	124 / 119 / 37
height / width (fixing distance between centres) / thickness (panel mount)	115 / 134 (118) / 37

APPROVALS



ACCESSORIES

End sections	grey beige
Permanent cross connection	
Rated current carrying capacity of jumper (A)	
Multiple common bar	250 mm
Shunting screw and sleeve	
Coloured partition	red, green, white
Cross connection barrier	red
Test plug socket	
Test plug	
Numbering strip	
Cover for cross-connection	
Mounting rail support	flat for PR/DIN and PR/3 sloped for PR/DIN and PR/3
Marking tag	printed or blank

Type	Cat. No.
-	-
-	-
-	-
-	-
-	-
-	-
-	-
-	-
-	-
-	-
-	-
ACI12123	Z12123
ACI121024	Z121024
CNU/8/51	NU0851
-	-

Type	Cat. No.
-	-
-	-
-	-
-	-
-	-
-	-
-	-
-	-
-	-
-	-
-	-
-	-
ACI12123	Z12123
ACI121024	Z121024
CNU/8/51	NU0851
-	-

End bracket	
-------------	--

BTU for PR/DIN and PR/3	BT005
CDA/BT for PR/DIN only	CD003
BT/3-BT0 for PR/3 only	BT003-BT007

BTU for PR/DIN and PR/3	BT005
CDA/BT for PR/DIN only	CD003
BT/3-BT0 for PR/3 only	BT003-BT007

Earth terminal blocks

with UL94V-0 polyamide insulating body

- mounted onto PR/3 profiles conforming to IEC 60715 standards, TH/35 type
- in 2 yellow / green shells
- same profile and dimensions of the corresponding terminal blocks of the CBC and GPA Series
- maximum continual operating temperature 100°C



version to be mounted onto PR/3 rail	TEC.6/0 Cat. No. T0120	TEC.10/0 Cat. No. T0510	TEC.16/0 Cat. No. T0220
TECHNICAL CHARACTERISTICS			
function/type	earth terminal block	earth terminal block	earth terminal block
rated cross-section (mm ²)	6	10	16
connecting capacity			
flexible (mm ²)	0.5 – 10	1.5 – 16	1.5 – 25
rigid (mm ²)	0.5 – 10	1.5 – 16	1.5 – 25
max. flexible with ferrule (mm ²) - ferrule type	6 - WP60/20	10 - WP100/21	16 - WP160/22
rated voltage / rated current / gauge conf. to IEC 60947-7-2	- / 41 A / A5	- / 57 A / B6	- / 76 A / B7
rated voltage / rated current / AWG	-	-	-
(Ex e) rated voltage / (V)	-	-	-
rated impulse withstand voltage / pollution degree	12 KV / 3	12 KV / 3	12 KV / 3
insulation stripping length (mm)	10	12	18
tightening torque value (test / max) (Nm)	0.8 / 1.4	1.2 / 1.9	-
height / width / thickness TH/35 7.5 mm	52 / 44 / 8	52 / 44 / 10	56 / 47 / 12
height / width / thickness TH/35 15 mm	60 / 44 / 8	60 / 44 / 10	64 / 47 / 12

APPROVALS



ACCESSORIES	Type	Cat. No.	Type	Cat. No.	Type	Cat. No.
End section	-	-	-	-	-	-
Marking tag printed or blank	CNU/8/51	NU0851	CNU/8/51	NU0851	CNU/8/51	NU0851
Numbering strip	-	-	-	-	-	-
End bracket	BTU for PR/DIN and PR/3	BT005	BTU for PR/DIN and PR/3	BT005	BTU for PR/DIN and PR/3	BT005
	BT/3-BTO for PR/3 only	BT003-BT007	BT/3-BTO for PR/3 only	BT003-BT007	BT/3-BTO for PR/3 only	BT003-BT007
	BT/DIN/PO for PR/DIN only	BT001	BT/DIN/PO for PR/DIN only	BT001	BT/DIN/PO for PR/DIN only	BT001
	PR/DIN/AC of steel	PR001	PR/DIN/AC of steel	PR001	PR/DIN/AC of steel	PR001
	PR/3/AS same with slots	PR004	PR/3/AS same with slots	PR004	PR/3/AS same with slots	PR004
	PR/DIN/AL of aluminium	PR002	PR/DIN/AL of aluminium	PR002	PR/DIN/AL of aluminium	PR002
	PR/3/AC of steel	PR003	PR/3/AC of steel	PR003	PR/3/AC of steel	PR003
	PR/3/AS same with slots	PR005	PR/3/AS same with slots	PR005	PR/3/AS same with slots	PR005

MAXIMUM SHORT-TIME WITHSTAND CURRENTS ALLOCATED TO THE RAIL PROFILE

Rail profile	Material	Equivalent E-cu cross-section mm ²	Short-time withstand current 1 s kA	Thermal rated current of a PEN busbar A
"Top hat" rail IEC 60715/TH 15 - 5.5	Steel	10	1.2	-
	Copper	25	3	101
	Aluminium	16	1.92	76
"Top hat" rail IEC 60715/TH 35 - 7.5	Steel	16	1.92	-
	Copper	50	6	150
	Aluminium	35	4.2	125
"Top hat" rail IEC 60715/TH 35 - 15	Steel	50	6	-
	Copper	150	18	309
	Aluminium	95	11.4	232

Taken from
CEI EN 60947-7-2
standard

Earth terminal blocks

with UL94V-0 polyamide insulating body

- mounted onto PR/3 profiles conforming to IEC 60715 standards, TH/35 type
- in 2 yellow / green shells
- same profile and dimensions of the corresponding terminal blocks of the CBC and GPA Series
- maximum continual operating temperature 100°C



version to be mounted onto PR/3 rail	TEC.35/0	TEC.70/0
	Cat. No. T0320	Cat. No. T0810
TECHNICAL CHARACTERISTICS		
function/type	earth terminal block	earth terminal block
rated cross-section (mm ²)	35	71
connecting capacity		
flexible (mm ²)	2.5 – 50	10 – 95
rigid (mm ²)	2.5 – 50	10 – 95
max. flexible with ferrule (mm ²) - ferrule type	-	-
rated voltage / rated current / gauge conf. to IEC 60947-7-2	- / 125 A / B9	- / 192 A / B11
rated voltage / rated current / AWG	-	-
(Ex e) rated voltage / (V)	-	-
rated impulse withstand voltage / pollution degree	12 KV / 3	12 KV / 3
insulation stripping length (mm)	18	25
tightening torque value (test / max) (Nm)	2.5 / 5	6 / 9 (Allen screw, 4 mm wrench)
height / width / thickness TH/35 7.5 mm	63 / 56 / 16	74 / 70 / 20.5
height / width / thickness TH/35 15 mm	71 / 56 / 16	81.5 / 70 / 20.5

APPROVALS



ACCESSORIES	Type	Cat. No.	Type	Cat. No.
End section	-	-	-	-
Marking tag printed or blank	CNU/8/51	NU0851	CNU/8/51	NU0851
Numbering strip	-	-	-	-
End bracket	BTU for PR/DIN and PR/3 BT/3-BTO for PR/3 only BT/DIN/PO for PR/DIN only	BT005 BT003-BT007 BT001	BTU for PR/DIN and PR/3 BT/3-BTO for PR/3 only BT/DIN/PO for PR/DIN only	BT005 BT003-BT007 BT001

MAXIMUM SHORT-TIME WITHSTAND CURRENTS ALLOCATED TO THE RAIL PROFILE				
Rail profile	Material	Equivalent E-cu cross-section mm ²	Short-time withstand current 1 s kA	Thermal rated current of a PEN busbar A
"Top hat" rail IEC 60715/TH 15 - 5.5	Steel	10	1.2	-
	Copper	25	3	101
	Aluminium	16	1.92	76
"Top hat" rail IEC 60715/TH 35 - 7.5	Steel	16	1.92	-
	Copper	50	6	150
	Aluminium	35	4.2	125
"Top hat" rail IEC 60715/TH 35 - 15	Steel	50	6	-
	Copper	150	18	309
	Aluminium	95	11.4	232

Taken from
CEI EN 60947-7-2
standard

CBD Series

Screw-clamp feed-through terminal blocks

- behaviour in flame UL94V-0
- universal mounting on PR/DIN and PR/3 rails in accordance with IEC 60715 standard
- certificate **CESI 01 ATEX 090 U Ex e** I M2 / II 2 G D temperature range of use: -40 – +80°C
- **CoC IEC Ex CES 09.0009U** Ex e II
- available in the standard version (beige) or in a version appropriate for use with “intrinsically safe” (Ex)i circuits (blue)
- maximum continual operating temperature 100°C

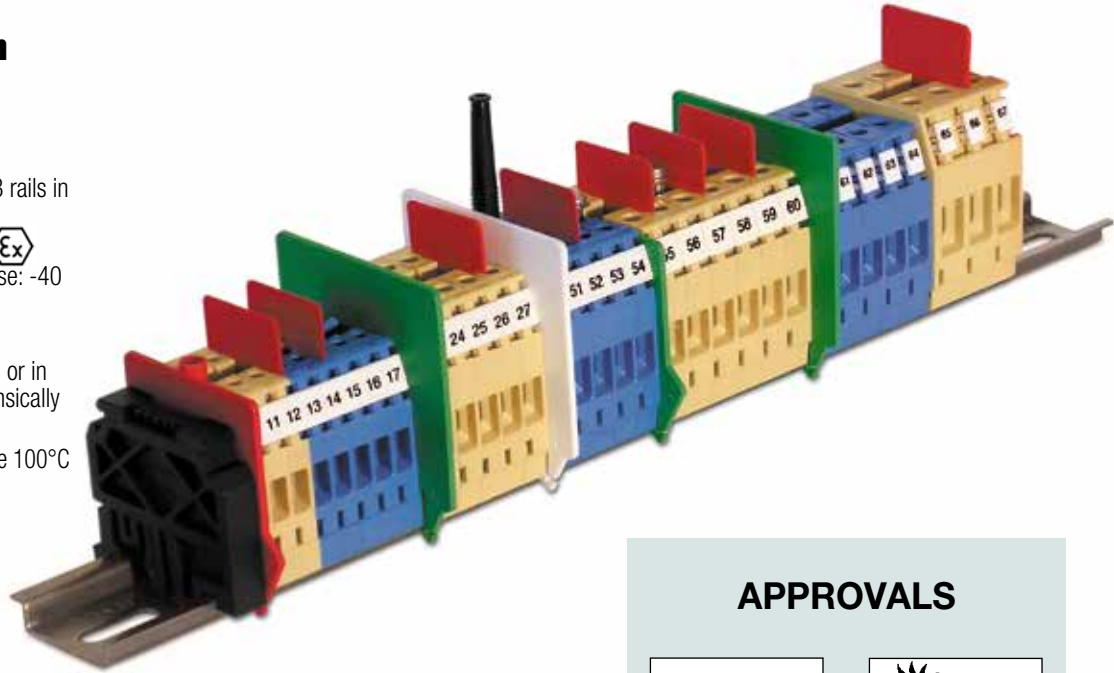

The CBD Series comprises eight sizes, distinguished by:

- very small space occupied
- large connecting capacity
- effective current capacity higher than established reference values
- very low contact resistance of the connection
- materials of excellent quality and, consequently, maximum reliability over time
- great practicality of use.

Cabur has always designated each product mainly with a Code, distinguished by a part in letters (generally 3) and a number, with an interposed dot.

This number defines the **rated cross-section** of the terminal in question; which as laid down in the reference Standard is *“the figure, expressed in mm², corresponding to the section of the connectable conductor, declared by the Manufacturer, to which the thermal, mechanical and electrical parameters of the product are referred”*.

The field of use of the terminal block is however much wider and is defined by its **connecting capacity**, that is the range of sections of conductors, both rigid and flexible, minimum and maximum, that the terminal block is capable of connecting, in full observance of all the parameters laid down in the reference Standards.

In the table provided below, in fact, the “classic” code of each terminal block has been supplemented with the addition, after the existing number, which still indicates the nominal size, of a second numeric value (in reduced character size and in red, separated from the first by a /) which represents the size, in mm², of the **maximum flexible conductor effectively connectable to the terminal block**. In the event of use of rigid conductors (with single wire or corded) it is necessary to check also what is stated in the technical specifications of each product, under the item “connecting capacity”, because in many cases the size of the maximum rigid conductor connectable is even larger.

Considering precisely the confirmed large connecting capacity, some sizes of the CBD Series have been reconsidered; without changing the eight sizes of the Series, the previous CBD.25 and CBD.35 models have been revised and, after the appropriate actions and all the consequent tests, restated respectively as **CBD.35** and **CBD.50**; this latter size, not considered in the past in the range of Cabur terminal blocks, is instead widely used.

APPROVALS

UL
U.S.A.-Canada

Terna
LV 27/1

KEMA - KEUR

CESI
ATEX Ex e
Italy

Enel
DV 27/1

R.I.N.A.
Italy

Type	Rated cross section (mm ²)	Flexible conductor (mm ²)		Rigid conductor (mm ²)		Gauge	Max. current (A)
		min.	max.	min.	max.		
CBD.2/4	2.5	0.5	4	0.5	4	A3	29
CBD.4/6	4	0.5	6	0.5	6	A4	40
CBD.6/10	6	0.5	10	0.5	10	A5	58
CBD.10/16	10	0.5	16	0.5	16	B6	77
CBD.16/25	16	0.5	25	0.5	25	B7	104
CBD.35/35	35	0.5	35	0.5	50	B8	147
CBD.50/50	50	1.5	50	1.0	70	B9	180
CBD.70/95	70	1.5	95	1.0	95	B11	250

Type of connection:

It is with a screw, on both sides, indirect and self-locking. The clamping screws are accessible only with a special screwdriver and the particular shape of the head makes them impossible to lose. The screw clamping offers the best guarantees of a mechanical seal and of effective passage of the current and is suitable for the connection, with or without special preparation, of conductors of all sections. The tightening and loosening operations are extremely simple and are carried out with commonly-used tools, namely screwdrivers; it is however important, in any case, to use screwdrivers of the right characteristics and dimensions so as not to cause damage either to the screw itself or to the insulating base.

Conducting body:

of the sleeve type, **made entirely of copper-zinc alloy with nickel-plating treatment**; the characteristics of the material used and the manufacturing methods are such as to avoid the phenomenon of possible breakages, known as "seasoning cracks".

Tightening reliability:

opportune orthogonal ribs, at the bottom of the sleeve and on the lower surface of the clamping platelets, ensure in the various situations perfect electrical contact with the conductors and efficient mechanical locking. The grip on the conductor is made particularly effective by the elastic function performed by the clamping platelet; this, in particular, under the pressure of the screw, tends to bend, thus exercising a reaction applied to the head of the screw itself, which opposes unscrewing, even in the presence of dynamic stresses (vibrations).

Ease of insertion:

Inserting the conductor in the terminal block is facilitated:

- by the inclined invitation surfaces made on the insulating base
- by the rounded shape of the clamping platelet
- by the adequate size of the introduction hole with respect to the diameter of the maximum insertable conductor. The conductor introduction depth is limited by a barrier fitted on the insulating base.

Other functions:

besides their main function of feed-through terminal blocks, the CBD terminal blocks are designed and made so as to be able to perform other functions. In fact, using a hole made in the upper part of the conducting body it is possible:

- to create a fixed or switchable transversal connection (cross connection) between two adjoining terminal blocks
- to create a multiple common bar connection between several adjoining terminal blocks
- to insert a socket for a test plug
- to insert a composable test plug for multiple signal testing.

Marking: all CBD terminal blocks offer the possibility of coding, on both sides, using the CNU/8, SNZ or CSC marking tags (this last system enables the composition of alphanumeric codes up to a maximum of four characters, six with the ADR/6 adapter).

Mounting: the polyamide terminal blocks of the CBD Series are made ready to be mounted indifferently on supporting rails of **G32** or **TH/35** type (IEC 60715 standard), with evident advantages and facilitations in procuring, managing and in general using the product.

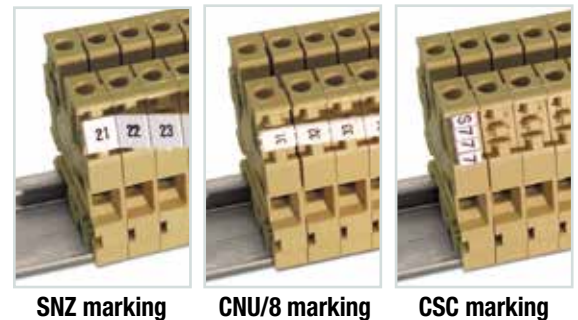
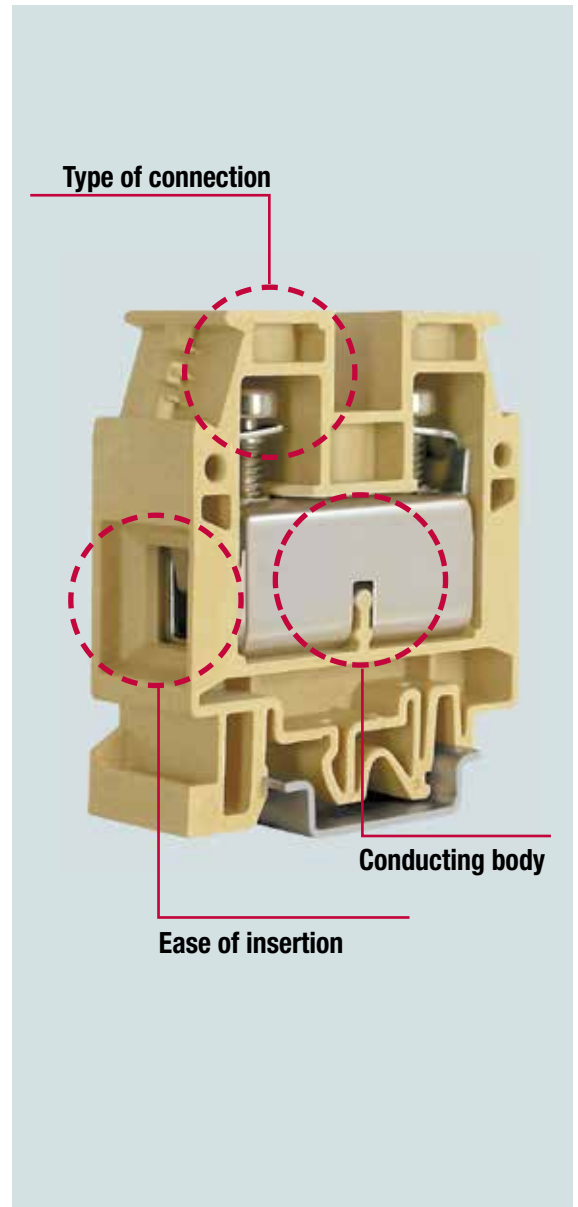

CBD Series

Screw-clamp feed-through terminal blocks

- behaviour in flame UL94V-0
- universal mounting on PR/DIN and PR/3 rails in accordance with IEC 60715 standard
- certificate **CESI 01 ATEX 090 U** Ex e I M2 / II 2 G D temperature range of use: -40 – +80°C
- **CoC IEC Ex CES 09.0009U** Ex e II
- available in the standard version (beige) or in a version appropriate for use with “intrinsically safe” (Ex)i circuits (blue)
- maximum continual operating temperature 100°C

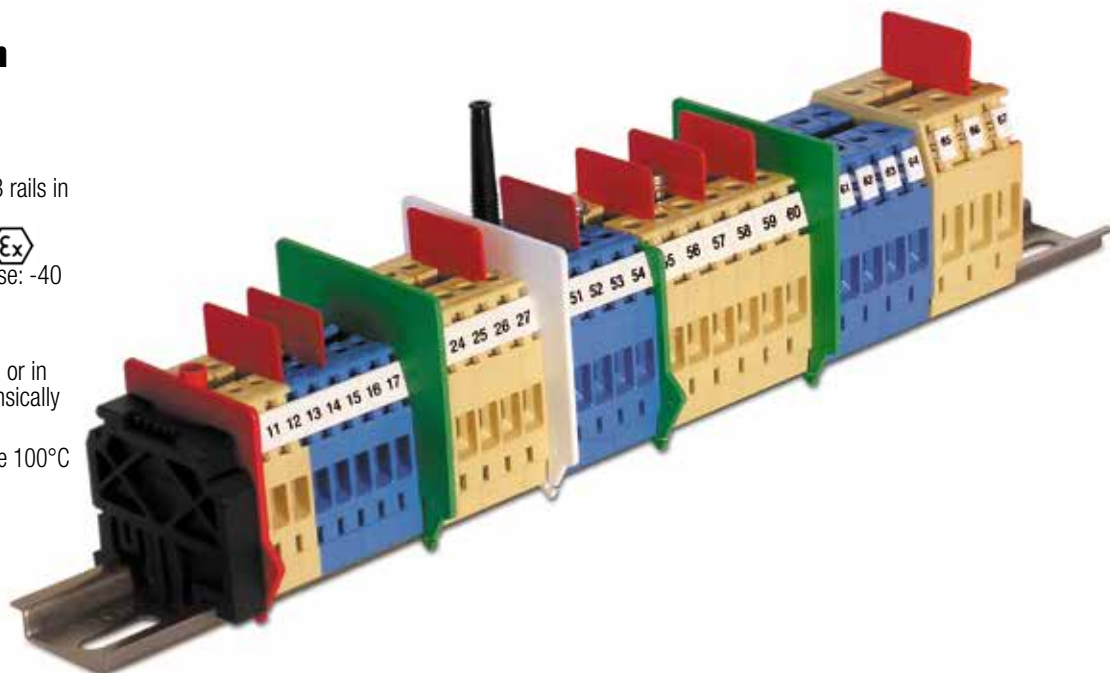

Accessories

- 1 End section
- 2 Permanent cross connection
- 3 Pre-assembled cross connection
- 4 Switchable cross connection
- 5 Multiple cross connection
- 6 Shunting screw and sleeve
- 7 Coloured partition
- 8 Cross connection barrier
- 9 Test plug socket
- 10 Test plug
- 11 Modular test plug
- 12 Warning plate
- 13 Cross connection cover
- 14 Marking tag
- 15 End bracket
- 16 Mounting rail
- 17 Numbering strip
- 18 Tag adapter

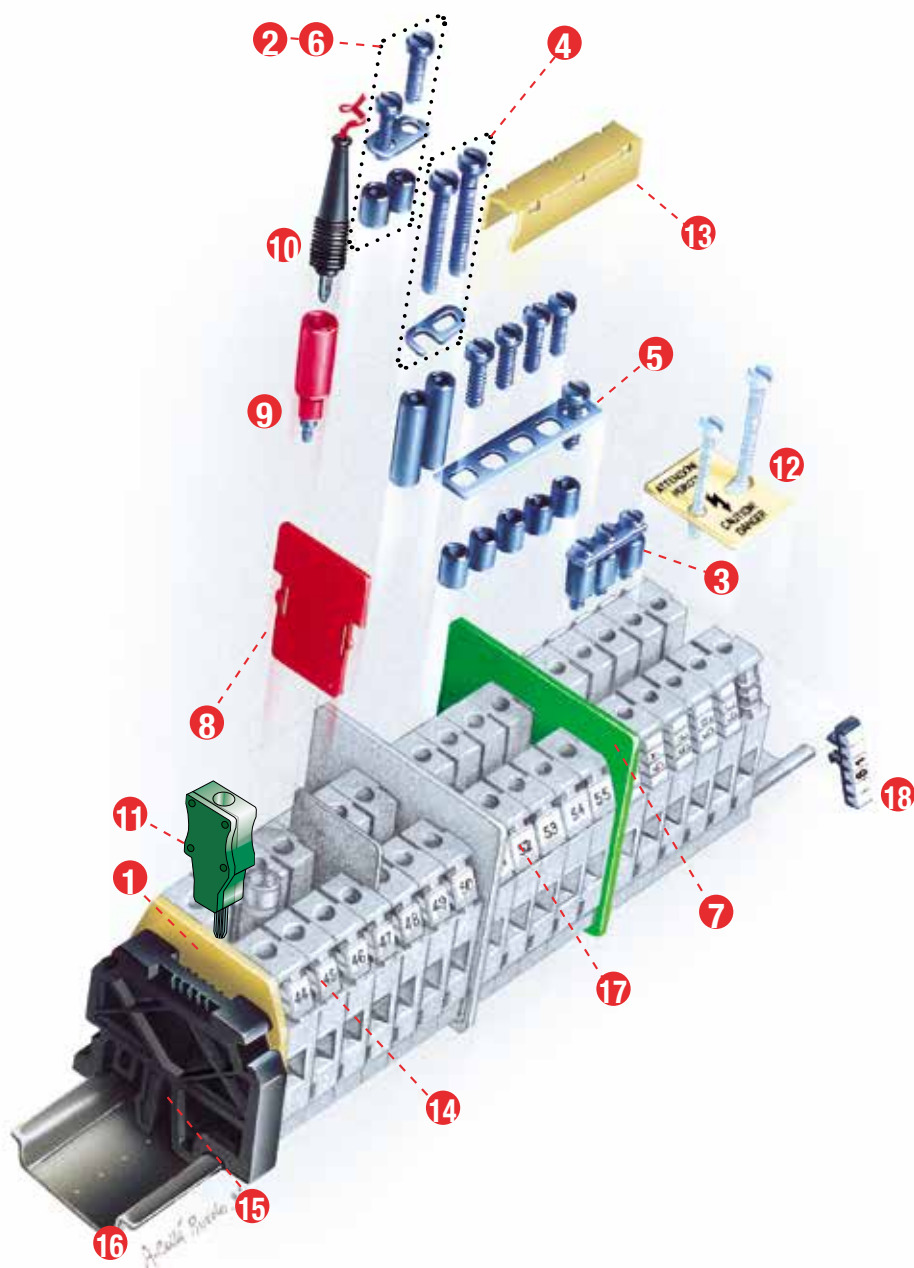

Various accessories (the picture shows those specific to the CBD Series, some of which are also used for other models)

CBD Series

- UL94V-0
- universal mounting for both PR/DIN and PR/3 rails which meet IEC 60715 norms, "G32" and TH/35 types
- certificate **CESI 01 ATEX 090 U Ex e** I M2 / II 2 G D temperature range of use: -40 – +80°C
- **CoC IEC Ex CES 09.0009U Ex e II**
- available in the standard version (beige) or in a version appropriate for use with "intrinsically safe" (Ex)i circuits (blue)
- maximum continual operating temperature 100°C



(*): 25 A factory wiring only

(**): 32 A factory wiring only

(***) if shielded cables are to be connected, when using CB/SH screening lug, the rated voltage is reduced to 200 V

standard version

(Ex)i version

TECHNICAL CHARACTERISTICS

function/type	
rated cross-section	(mm ²)
connecting capacity	
flexible	(mm ²)
rigid	(mm ²)
max. flexible with ferrule (mm ²) - ferrule type	
rated voltage / rated current / gauge	conf. to IEC 60947-7-1
rated voltage / rated current / AWG / tightening torque value	UL
(Ex e) rated voltage	(V)
rated impulse withstand voltage / pollution degree	
insulation stripping length	(mm)
tightening torque value (test / max)	(Nm)
height / width / thickness	TH/35 7.5 mm
height / width / thickness	TH/35 15 mm
height / width / thickness	G32

APPROVALS

ACCESSORIES

End sections	beige blue
Permanent cross connection	
Rated current carrying capacity of jumper (same, Ex e version)	(A)
Switchable cross connection	
Multiple common bar	250 mm
Shunting screw and sleeve (same, Ex e version)	
Coloured partition	red
Cross connection barrier	red
Test plug socket	
Test plug	
Modular test plug	
End section for modular test plug	
Numbering strip	
Warning plate	on adjacent terminal blocks
Cover for cross-connection	
Marking tag	printed or blank
End bracket	
Screening lug	

CBD.2

Cat. No. **CB110**

CBD.2 (Ex)i

Cat. No. **CBX12**



feed-through	2.5
flexible	0.5 – 4
rigid	0.5 – 4
max. flexible with ferrule (mm ²) - ferrule type	2.5 - WP25/14
rated voltage / rated current / gauge	690 V / 24 A / A3
rated voltage / rated current / AWG / tightening torque value	600 V / 20 A (*) / 20-12 AWG / 5.5 lb.in
(Ex e) rated voltage	400 V / 630 V
rated impulse withstand voltage / pollution degree	8 KV / 3
insulation stripping length	13
tightening torque value (test / max)	0.4 / 0.8
height / width / thickness	47 / 40.5 / 5.5
height / width / thickness	55 / 40.5 / 5.5
height / width / thickness	51 / 40.5 / 5.5



Type

CB2/PT	CB111
CB2/PT (Ex)i	CBX13
PM/20/2 poles (pre-assembled)	PM202
PM/20/3 poles (pre-assembled)	PM203
PM/20/5 poles (pre-assembled)	PM205
PM/20/10 poles (pre-assembled)	PM210
24 / (24)	
POS/11	POS11
PMP/01 /45 poles	PMP01
CPM/21 (CPX/21)	CPM21 (CPX21)
DFU/1/R	DU01R
DFM/600	DF600
PSD/D	PD004
SDD/1	DD001
SDD/5	DD005
SD5/PT	DD501
-	
TQM/02 on 4	TQM02
-	
PRP/6	PRP06
CNU/8/51	NU0851
BTU for PR/DIN and PR/3	BT005
BT/DIN/PO for PR/DIN only	BT001
BT/3-BTO for PR/3 only	BT003-BT007
CBD/SH (***)	CB009

CBD.4

Cat. No. **CB240**

CBD.4 (Ex)i

Cat. No. **CBX24**

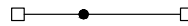

feed-through	4
flexible	0.5 – 6
rigid	0.5 – 6
max. flexible with ferrule (mm ²) - ferrule type	4 - WP40/16
rated voltage / rated current / gauge	1000 V / 32 A / A4
rated voltage / rated current / AWG / tightening torque value	600 V / 30 A (**) / 20-10 AWG / 8.9 lb.in
(Ex e) rated voltage	500 V / 630 V
rated impulse withstand voltage / pollution degree	12 KV / 3
insulation stripping length	14
tightening torque value (test / max)	0.5 / 1.2
height / width / thickness	52 / 44 / 6.5
height / width / thickness	60 / 44 / 6.5
height / width / thickness	56 / 44 / 6.5



Type

CB4/6/PT	CB241
CB4/6/PT (Ex)i	CBX25
PM/40/2 poles (pre-assembled)	PM402
PM/40/3 poles (pre-assembled)	PM403
PM/40/5 poles (pre-assembled)	PM405
PM/40/10 poles (pre-assembled)	PM400
32 / (32)	
POS/42	POS42
PMP/42 /38 poles	PMP42
CPM/12 (CPX/12)	CPM12 (CPX12)
DFU/4/R	DU04R
DFM/600	DF600
PSD/A	PD001
SDD/1	DD001
SDD/6	DD006
SD6/PT	DD601
-	
TTM/12 on 3 and on 4	TTM12
-	
PRP/6	PRP06
CNU/8/51	NU0851
BTU for PR/DIN and PR/3	BT005
BT/DIN/PO for PR/DIN only	BT001
BT/3-BTO for PR/3 only	BT003-BT007
CBD/SH (***)	CB009

CBD.6

Cat. No. **CB340**

CBD.6 (Ex)i

Cat. No. **CBX34**

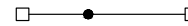

feed-through	6
flexible	0.5 – 10
rigid	0.5 – 10
max. flexible with ferrule (mm ²) - ferrule type	6 - WP60/20
rated voltage / rated current / gauge	1000 V / 41 A / A5
rated voltage / rated current / AWG / tightening torque value	600 V / 50 A / 20-8 AWG / 13.3 lb.in
(Ex e) rated voltage	500 V / 630 V
rated impulse withstand voltage / pollution degree	12 KV / 3
insulation stripping length	14
tightening torque value (test / max)	0.8 / 1.4
height / width / thickness	52 / 44 / 8
height / width / thickness	60 / 44 / 8
height / width / thickness	56 / 44 / 8



Type

CB4/6/PT	CB241
CB4/6/PT (Ex)i	CBX25
PM/60/2 poles (pre-assembled)	PM602
PM/60/3 poles (pre-assembled)	PM603
PM/60/5 poles (pre-assembled)	PM605
PM/60/10 poles (pre-assembled)	PM610
41 / (41)	
POS/93	POS93
PMP/13 /31 poles	PMP13
CPM/83 (CPX/83)	CPM83 (CPX83)
DFU/4/R	DU04R
DFM/600	DF600
PSD/N	PD013
SDD/1	DD001
-	
-	
TTM/15 on 3	TTM15
TQM/15 on 4	TQM15
PRP/7	PRP07
CNU/8/51	NU0851
BTU for PR/DIN and PR/3	BT005
BT/DIN/PO for PR/DIN only	BT001
BT/3-BTO for PR/3 only	BT003-BT007
CBD/SH (***)	CB009

CBD Series

- UL94V-0
- universal mounting for both PR/DIN and PR/3 rails which meet the IEC 60715 standard, "G32" and TH/35 types
- certificate **CESI 01 ATEX 090 U Ex e** I M2 / II 2 G D temperature range of use: -40 – +80°C
- **CoC IEC Ex CES 09.0009U** Ex e II
- available in the standard version (beige) or in a version appropriate for use with "intrinsically safe" (Ex)i circuits (blue)
- maximum continual operating temperature 100°C



(*) if shielded cables are to be connected when using CB/SH screening lug, the rated voltage is reduced to 250 V

standard version

(Ex)i version

TECHNICAL CHARACTERISTICS

function/type	
rated cross-section	(mm ²)
connecting capacity	
flexible	(mm ²)
rigid	(mm ²)
max. flexible with ferrule (mm ²) - ferrule type	
rated voltage / rated current / gauge	conf. to IEC 60947-7-1
rated voltage / rated current / AWG / tightening torque value	UL
(Ex e) rated voltage	(V)
rated impulse withstand voltage / pollution degree	
insulation stripping length	(mm)
tightening torque value (test / max)	(Nm)
height / width / thickness	TH/35 7.5 mm
height / width / thickness	TH/35 15 mm

APPROVALS

ACCESSORIES

End sections	beige blue
Permanent cross connection	
Rated current carrying capacity of jumper (same, Ex e version)	(A)
Switchable cross connection	
Multiple common bar	250 mm
Shunting screw and sleeve (same, Ex e version)	
Coloured partition	red, green, white
Cross connection barrier	red
Test plug socket	
Test plug	
Modular test plug	
End section for modular test plug	
Numbering strip	
Warning plate	on adjacent terminal blocks
Cover for cross-connection	
Marking tag	printed or blank
End bracket	
Mounting rail according to IEC 60715 Std.	
Screening lug	

CBD.10

CBD.10 (Ex)i

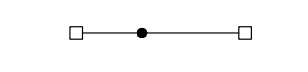

feed-through	10
flexible	0.5 – 16
rigid	0.5 – 16
max. flexible with ferrule (mm ²) - ferrule type	10 - WP100/21
rated voltage / rated current / gauge	1000 V / 57 A / B6
rated voltage / rated current / AWG / tightening torque value	600 V / 60 A / 20-6 AWG / 13.3 lb.in
(Ex e) rated voltage	500 V / 630 V
rated impulse withstand voltage / pollution degree	12 KV / 3
insulation stripping length	14
tightening torque value (test / max)	1.2 / 1.9
height / width / thickness	55 / 44 / 10
height / width / thickness	63 / 44 / 10



Type	Cat. No.
CB10/PT	CB431
CB10/PT (Ex)i	CBX44
PM10/2 poles (pre-assembled)	PM102
PM10/3 poles (pre-assembled)	PM103
PM10/5 poles (pre-assembled)	PM105
PM10/10 poles (pre-assembled)	PM100
57 / (57)	
POS/44	POS44
PMP/04 /25 poles	PMP04
CPM/03 (CPX/03)	CPM03 (CPX03)
DFU/4	DU04..
DFM/700	DF700
PSD/B	PD002
SDD/2	DD002
-	-
-	-
-	-
TUM/04 on 3	TUM04
TQM/04 on 4	TQM04
PRP/7	PRP07
CNU/8/51	NU0851
BTU for PR/DIN and PR/3	BT005
BT/DIN/PO for PR/DIN only	BT001
BT/3-BTO for PR/3 only	BT003-BT007
PR/DIN/AC in steel	PRO01
PR/DIN/AS same with slots	PRO04
PR/DIN/AL of aluminium	PRO02
PR/3/AC of steel	PRO03
PR/3/AS same with slots	PRO05
CB0/SH (*)	CB009

CBD.16

CBD.16 (Ex)i

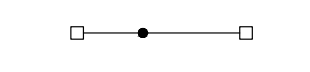

feed-through	16
flexible	0.5 – 25
rigid	0.5 – 25
max. flexible with ferrule (mm ²) - ferrule type	16 - WP160/22
rated voltage / rated current / gauge	1000 V / 76 A / B7
rated voltage / rated current / AWG / tightening torque value	600 V / 100 A / 20-3 AWG / 19.9 lb.in
(Ex e) rated voltage	630 V / 630 V
rated impulse withstand voltage / pollution degree	12 KV / 3
insulation stripping length	18
tightening torque value (test / max)	1.8 / 3
height / width / thickness	57 / 47 / 12
height / width / thickness	65 / 47 / 12



Type	Cat. No.
CB16/PT	CB511
CB16/PT (Ex)i	CBX53
POF/44 (PFX/44)	POF44 (PFX44)
(same, Ex e version)	
76 / (76)	
POS/44	POS44
PMP/05 /21 poles	PMP05
CPM/44 (CPX/44)	CPM44 (CPX44)
DFU/4	DU04..
DFM/700	DF700
PSD/B	PD002
SDD/2	DD002
-	-
-	-
-	-
TUM/05 on 3 and on 4	TUM05
-	-
PRP/7	PRP07
CNU/8/51	NU0851
BTU for PR/DIN and PR/3	BT005
BT/DIN/PO for PR/DIN only	BT001
BT/3-BTO for PR/3 only	BT003-BT007
PR/DIN/AC in steel	PRO01
PR/DIN/AS same with slots	PRO04
PR/DIN/AL of aluminium	PRO02
PR/3/AC of steel	PRO03
PR/3/AS same with slots	PRO05
-	-

CBD.35

CBD.35 (Ex)i

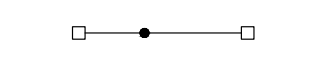

feed-through	35
flexible	0.5 – 35
rigid	0.5 – 50
max. flexible with ferrule (mm ²) - ferrule type	35 - WP350/30
rated voltage / rated current / gauge	1000 V / 125 A / B8
rated voltage / rated current / AWG / tightening torque value	600 V / 125 A / 16 – 1 AWG / 22.1 lb.in
(Ex e) rated voltage	630 V / 630 V
rated impulse withstand voltage / pollution degree	12 KV / 3
insulation stripping length	20
tightening torque value (test / max)	2 / 3.5
height / width / thickness	60 / 52 / 16
height / width / thickness	68 / 52 / 16



Type	Cat. No.
CB35/PT	CB611
CB35/PT (Ex)i	CBX63
POF/06 (PFX/06)	POF06 (PFX06)
(same, Ex e version)	
125 / (125)	
POS/66	POS66
PMP/06 /16 poles	PMP06
CPM/06 (CPX/06)	CPM06 (CPX06)
DFU/5	DU05..
DFM/700	DF700
PSD/B	PD002
SDD/2	DD002
-	-
-	-
-	-
TUM/06 on 3 and on 4	TUM06
-	-
PRP/8	PRP08
CNU/8/51	NU0851
BTU for PR/DIN and PR/3	BT005
BT/DIN/PO for PR/DIN only	BT001
BT/3-BTO for PR/3 only	BT003-BT007
PR/DIN/AC in steel	PRO01
PR/DIN/AS same with slots	PRO04
PR/DIN/AL of aluminium	PRO02
PR/3/AC of steel	PRO03
PR/3/AS same with slots	PRO05
-	-

CBD Series

- UL94V-0
- universal mounting for both PR/DIN and PR/3 rails which meet IEC 60715 norms, "G32" and TH/35 types
- certificate **CESI 01 ATEX 090 U** Ex e I M2 / II 2 G D temperature range of use: -40 – +80°C
- **CoC IEC Ex CES 09.0009U** Ex e II
- available in standard beige and grey version or in a version appropriate for use with "intrinsically safe" (Ex)i circuits (blue)
- maximum continual operating temperature 100°C



(*): 150 A factory wiring only

standard version

grey version

(Ex)i version

TECHNICAL CHARACTERISTICS

function/type	
rated cross-section	(mm ²)
connecting capacity	
flexible	(mm ²)
rigid	(mm ²)
max. flexible with ferrule (mm ²) - ferrule type	
rated voltage / rated current / gauge	conf. to IEC 60947-7-1
rated voltage / rated current / AWG / tightening torque value	UL
(Ex e) rated voltage	/ (V)
rated impulse withstand voltage / pollution degree	
insulation stripping length	(mm)
tightening torque value (test / max)	(Nm)
height / width / thickness	TH/35 7.5 mm
height / width / thickness	TH/35 15 mm
height / width / thickness	G32

APPROVALS

ACCESSORIES

End sections	beige grey blue
Permanent cross connection (same, Ex e version)	
Rated current carrying capacity of jumper (same, Ex e version)	(A)
Switchable cross connection	
Multiple common bar	250 mm
Shunting screw and sleeve (same, Ex e version)	
Coloured partition	red, green, white
Cross connection barrier	red
Test plug socket	
Test plug	
Modular test plug	
End section for modular test plug	
Numbering strip	
Warning plate	on adjacent terminal blocks
Cover for cross-connection	
Marking tag	printed or blank
End bracket	
Mounting rail according to IEC 60715 Std.	
Screening lug	

CBD.50

Cat. No. **CB710**

CBD.50/GR

Cat. No. **CB710GR**

CBD.50 (Ex)i

Cat. No. **CBX72**

feed-through	50
	1.5 – 50
	1 – 70
	50 - WP500/40
	1000 V / 150 A / B9
	600 V / 130 A (*) / 16-1 AWG / 33.2 lb.in.
	630 V / 630 V
	12 KV / 3
	22
	2.5 / 5
	62 / 57 / 18
	70 / 57 / 18
	66 / 57 / 18



Type

Type	Cat. No.
CB50/PT	CB711
CB50/PT/GR	CB711GR
CB50/PT (Ex)i	CBX73
POF/07 (PFX/07)	POF07 (PFX07)
150 / (150)	
POS/77	POS77
PMP/07 /14 poles	PMP07
CPM/07 (CPX/07)	CPM07 (CPX07)
DFU/5	DU05..
DFM/700	DF700
PSD/C	PD003
SDD/2	DD002
-	-
-	-
-	-
TUM/07 on 3 and on 4	TUM07
-	-
PRP/8	PRP08
CNU/8/51	NU0851
-	-
BTU for PR/DIN and PR/3	BT005
BT/DIN/PO for PR/DIN only	BT001
BT/3-BTO for PR/3 only	BT003-BT007
PR/DIN/AC in steel	PRO01
PR/DIN/AS same with slots	PRO04
PR/DIN/AL of aluminium	PRO02
PR/3/AC of steel	PRO03
PR/3/AS same with slots	PRO05
-	-

CBD.70

Cat. No. **CB810**

CBD.70/GR

Cat. No. **CB810GR**

CBD.70 (Ex)i

Cat. No. **CBX82**

feed-through	70
	1.5 – 95
	1 – 95
	-
	1000 V / 192 A / B11
	600 V / 220 A / 12 - 4/0 AWG / 50 lb. in.
	630 V / 630 V
	12 KV / 3
	26
	3 / 8
	71 / 62 / 20.5
	79 / 62 / 20.5
	75 / 62 / 20.5



Type

Type	Cat. No.
CB70/PT	CB811
CB70/PT/GR	CB811GR
CB70/PT (Ex)i	CBX83
POF/08 (PFX/08)	POF08 (PFX08)
192 / (155)	
POS/08	POS08
PMP/08 /12 poles	PMP08
CPM/08 (CPX/08)	CPM08 (CPX08)
DFU/6	DU06..
DFM/700	DF700
PSD/C	PD003
SDD/2	DD002
-	-
-	-
-	-
TUM/08 on 3 and on 4	TUM08
-	-
PRP/8	PRP08
CNU/8/51	NU0851
-	-
BTU for PR/DIN and PR/3	BT005
BT/DIN/PO for PR/DIN only	BT001
BT/3-BTO for PR/3 only	BT003-BT007
PR/DIN/AC in steel	PRO01
PR/DIN/AS same with slots	PRO04
PR/DIN/AL of aluminium	PRO02
PR/3/AC of steel	PRO03
PR/3/AS same with slots	PRO05
-	-

GPM Series high current terminal blocks

with polyamide insulating body

- mounting for both PR/DIN and PR/3 rails which meet IEC 60715 norms, "G32" and TH/35 types
- nominal voltage 1000 V
- panel mount version
- possibility of parallel cross connection
- available in the /BB (bar-bar), /BC (bar-cable), /CC (cable-cable) versions
- available in grey and beige
- **CESI 13 ATEX 038U** certificate
I M2 Ex e I Mb
II 2G Ex e IIC Gb temperature range of use -40 — +80°C
- **CoC IEC Ex CES 13.0012U**
- maximum continual operating temperature 100°C



Tightening reliability: the reliability of the connection (wire terminal or bar) is guaranteed by a screw and locking nut, with the interposition of a flat washer and an elastic washer, useful above all for countering the effects of the dynamic stresses. In the versions made ready for clamping of the conductors, without preparation. The reliability of the connection is ensured by the action and the particular wrapping shape of the clamping clip, the elastic reaction of which to the force pressing down on the conductor works as a lock under the head of the clamping screw, stopping it from loosening, even in the presence of vibrations. The conductor bar is also made with an appropriate concave seat so as to increase the grip of the conductors; in addition both the contact surface of the clamping clip and the concave part of the bar feature, along the entire length, crosswise channels that help to improve the connection characteristics, as regards both the mechanical retention of the conductors and the electrical contact, guaranteeing low contact resistances.

- **protection for the "bar" versions:** this protection which in the normal installation conditions has a longitudinal position with respect to the axis of the terminal block, can easily be rotated, using a simple screwdriver (as prescribed by the safety standards). In this way it is possible to access the connection unit to be able to work on the wire terminals or on the bars;
- **protection for the "cable" versions:** in this case the protection is fixed and snaps in: its development is orthogonal to the axis of the terminal block and it protects the collar, the clip and the clamping screw. It is worth noting the "shutter" device, fitted on the protection in axis to the terminal block and in line with the conductor introduction hole, which enables, with manual action in maximum conditions of safety, partial or total closing of the hole itself and consequently protection of the live parts, in the case of use of conductors with a much smaller section than the nominal one or cabling of the terminal block from only one side.

Mounting: for these power terminal blocks, owing to the notable dimensions and because they are subject to high stresses due to the forces generated by the conductors, a new hooking system has been studied and created. This enables it to be mounted indifferently on the various types of standard mounting rail (IEC 60715). The terminal block is unhooked simply using a screwdriver, inserted in the special slot provided in the hooking system (yellow part). If the mounting rail itself is installed on a flat wall, the dimensions of the GPM terminal blocks make it indispensable to use flat brackets to space the terminal board from the surface adequately. For each terminal block of the Series the version for direct fixing to a panel (/FIX) is also available.

Marking: the GPM terminal blocks enable identification from both sides which can be done with both the CNU/8 (2 elements) and the CSC (up to 5 elements) type marking tags: the two possibilities are not alternatives, but can be combined.

Cross-connection: on this Series of terminal blocks it is also possible to create a cross connection between 2 or 3 adjacent terminal blocks using opportune cross connections; to insert this accessory it is necessary to remove the insulating baffle pre-engraved on the side wall of the insulating body.



GPM Series high current terminal blocks

- mounting for both PR/DIN and PR/3 rails which meet IEC 60715 norms, "G32" and TH/35 types
- nominal voltage 1000 V
- panel mount version - M6 screws (recommended with screwdriver and washer slot)
- possibility of parallel cross connection
- available in beige and grey
- **CESI 13 ATEX 038U** certificate
I M2 Ex e I Mb
II 2G Ex e IIC Gb temperature range of use
-40 — +80°C
- **CoC IEC Ex CES 13.0012U**
- maximum continual operating temperature 100°C



standard version



panel-mount version

(*) distance between the cable lug fixing screw axis and the conducting body: 10 mm

(*) distance between the cable lug fixing screw axis and the conducting body: 12 mm

(*) distance between the cable lug fixing screw axis and the conducting body: 15 mm

standard version	GPM.95/BB Cat. No. GP100	GPM.150/BB Cat. No. GP400	GPM.240/BB Cat. No. GP700
grey version	GPM.95/BB/GR Cat. No. GP100GR	GPM.150/BB/GR Cat. No. GP400GR	GPM.240/BB/GR Cat. No. GP700GR
panel-mount version	GPM.95/BB/FIX Cat. No. GP110	GPM.150/BB/FIX Cat. No. GP410	GPM.240/BB/FIX Cat. No. GP710
panel-mount version	GPM.95/BB/FIX/GR Cat. No. GP110GR	GPM.150/BB/FIX/GR Cat. No. GP410GR	GPM.240/BB/FIX/GR Cat. No. GP710GR

TECHNICAL CHARACTERISTICS

function/type	feed-through	feed-through	feed-through
rated cross-section (mm ²)	95/150	150/240	240/300
connecting capacity			
flexible (mm ²)	-	-	-
rigid (mm ²)	-	-	-
bars and/or cable lugs	22 mm maximum width (M8 bolt) (*)	32 mm maximum width (M10 bolt) (*)	40 mm maximum width (M12 bolt) (*)
rated voltage / rated current / gauge conf. to IEC 60947-7-1	1000 V / 232 A	1000 V / 309 A	1000 V / 415 A
rated voltage / rated current / AWG UL	-	-	-
maximum current	320A	440A	600A
rated impulse withstand voltage / pollution degree	12 KV / 3	12 KV / 3	12 KV / 3
insulation stripping length (mm)	-	-	-
tightening torque value - bar (test / recommended) (Nm)	6 / 9 (13 mm wrench)	10 / 15 (key 17 mm)	14 / 21 (key 19 mm)
tightening torque value - cable (test / recommended) (Nm)	-	-	-
height / width / thickness TH/35 7.5 mm	81 / 176 / 32	81 / 200 / 42	89 / 250 / 52
height / width / thickness TH/35 15 mm	88 / 176 / 32	88 / 200 / 42	96 / 250 / 52
height / width / thickness G32	85 / 176 / 32	85 / 200 / 42	93 / 250 / 52
height / width (fixing distance between centres) / thickness (panel mount)	76 / 176 (158) / 32	76 / 200 (158) / 42	84 / 250 (172) / 52



APPROVALS

ACCESSORIES	Type	Cat. No.	Type	Cat. No.	Type	Cat. No.
End sections	-	-	-	-	-	-
Permanent cross connection	POF/95/2 poles	P0952	PFX/150/2 poles	PX152	PFX/240/2 poles	PX242
	POF/95/3 poles	P0953	PFX/150/3 poles	PX153	PFX/240/3 poles	PX243
Switchable cross connection	-	-	-	-	-	-
Multiple common bar	-	-	-	-	-	-
Shunting screw and sleeve	-	-	-	-	-	-
Coloured partition	-	-	-	-	-	-
Cross connection barrier	-	-	-	-	-	-
Test plug socket	-	-	-	-	-	-
Test plug	-	-	-	-	-	-
Numbering strip	-	-	-	-	-	-
Cover for cross-connection	-	-	-	-	-	-
Mounting rail support	ACI121213	Z121213	ACI121213	Z121213	ACI121213	Z121213
	ACI121024	Z121024	ACI121024	Z121024	ACI121024	Z121024
Marking tag	CNU/8/51	NU0851	CNU/8/51	NU0851	CNU/8/51	NU0851
End bracket	BTU for PR/DIN and PR/3	BT005	BTU for PR/DIN and PR/3	BT005	BTU for PR/DIN and PR/3	BT005
	BT/3-BTO for PR/3 only	BT003-BT007	BT/3-BTO for PR/3 only	BT003-BT007	BT/3-BTO for PR/3 only	BT003-BT007

GPM Series high current terminal blocks

- mounting for both PR/DIN and PR/3 rails which meet IEC 60715 norms, "G32" and TH/35 types
- nominal voltage 1000 V
- panel mount version - M6 screws (recommended with screwdriver and washer slot)
- possibility of parallel cross connection
- available in beige
- maximum continual operating temperature 100°C



standard version



panel-mount version

(* distance between the cable lug fixing screw axis and the conducting body: 10 mm

(* distance between the cable lug fixing screw axis and the conducting body: 12 mm

(* distance between the cable lug fixing screw axis and the conducting body: 15 mm

standard version with covers
standard version without covers
panel-mount version with covers
panel-mount version without covers

GPM.95/C/BB Cat. No. GP125
GPM.95/O/BB Cat. No. GP120
GPM.95/C/BB/FIX Cat. No. GP135
GPM.95/O/BB/FIX Cat. No. GP130

GPM.150/C/BB Cat. No. GP425
GPM.150/O/BB Cat. No. GP420
GPM.150/C/BB/FIX Cat. No. GP435
GPM.150/O/BB/FIX Cat. No. GP430

GPM.240/C/BB Cat. No. GP725
GPM.240/O/BB Cat. No. GP720
GPM.240/C/BB/FIX Cat. No. GP735
GPM.240/O/BB/FIX Cat. No. GP730

TECHNICAL CHARACTERISTICS

function/type	
rated cross-section (mm ²)	
connecting capacity	
flexible (mm ²)	
rigid (mm ²)	
bars and/or cable lugs	
rated voltage / rated current / gauge	conf. to IEC 60947-7-1
rated voltage / rated current / AWG	UL
maximum current	
rated impulse withstand voltage / pollution degree	
insulation stripping length (mm)	
tightening torque value - bar (test / recommended) (Nm)	
tightening torque value - cable (test / recommended) (Nm)	
height / width / thickness	TH/35 7.5 mm
height / width / thickness	TH/35 15 mm
height / width / thickness	G32
height / width (fixing distance between centres) / thickness (panel mount)	

feed-through	95
connecting capacity	-
flexible (mm ²)	-
rigid (mm ²)	-
bars and/or cable lugs	22 mm maximum width (M8 bolt) (*)
rated voltage / rated current / gauge	1000 V / 232 A
rated voltage / rated current / AWG	-
maximum current	248 A
rated impulse withstand voltage / pollution degree	12 KV / 3
insulation stripping length (mm)	-
tightening torque value - bar (test / recommended) (Nm)	6 / 9 (13 mm wrench)
tightening torque value - cable (test / recommended) (Nm)	-
height / width / thickness	81 / 176 / 32
height / width / thickness	88 / 176 / 32
height / width / thickness	85 / 176 / 32
height / width (fixing distance between centres) / thickness (panel mount)	76 / 176 (158) / 32

feed-through	150
connecting capacity	-
flexible (mm ²)	-
rigid (mm ²)	-
bars and/or cable lugs	32 mm maximum width (M10 bolt) (*)
rated voltage / rated current / gauge	1000 V / 309 A
rated voltage / rated current / AWG	-
maximum current	365 A
rated impulse withstand voltage / pollution degree	12 KV / 3
insulation stripping length (mm)	-
tightening torque value - bar (test / recommended) (Nm)	10 / 15 (key 17 mm)
tightening torque value - cable (test / recommended) (Nm)	-
height / width / thickness	81 / 200 / 42
height / width / thickness	88 / 200 / 42
height / width / thickness	85 / 200 / 42
height / width (fixing distance between centres) / thickness (panel mount)	76 / 200 (158) / 42

feed-through	240/300
connecting capacity	-
flexible (mm ²)	-
rigid (mm ²)	-
bars and/or cable lugs	40 mm maximum width (M12 bolt) (*)
rated voltage / rated current / gauge	1000 V / 415 A
rated voltage / rated current / AWG	-
maximum current	530 A
rated impulse withstand voltage / pollution degree	12 KV / 3
insulation stripping length (mm)	-
tightening torque value - bar (test / recommended) (Nm)	14 / 21 (key 19 mm)
tightening torque value - cable (test / recommended) (Nm)	-
height / width / thickness	89 / 250 / 52
height / width / thickness	96 / 250 / 52
height / width / thickness	93 / 250 / 52
height / width (fixing distance between centres) / thickness (panel mount)	84 / 250 (172) / 52

APPROVALS



ACCESSORIES

End sections	beige
Permanent cross connection	
Switchable cross connection	
Multiple common bar	250 mm
Shunting screw and sleeve	
Coloured partition	red, green, white
Cross connection barrier	red
Test plug socket	
Test plug	
Numbering strip	
Cover for cross-connection	
Mounting rail support	flat for PR/DIN and PR/3 sloped for PR/DIN and PR/3
Marking tag	printed or blank
End bracket	

Type	Cat. No.
-	-
POF/95/2 poles	P0952
POF/95/3 poles	P0953
-	-
-	-
-	-
-	-
-	-
-	-
-	-
-	-
-	-
-	-
ACI121213	Z121213
ACI121024	Z121024
CNU/8/51	NU0851
-	-
BTU for PR/DIN and PR/3	BT005
BT/3-BTO for PR/3 only	BT003-BT007

Type	Cat. No.
-	-
PFX/150/2 poles	PX152
PFX/150/3 poles	PX153
-	-
-	-
-	-
-	-
-	-
-	-
-	-
-	-
-	-
-	-
ACI121213	Z121213
ACI121024	Z121024
CNU/8/51	NU0851
-	-
BTU for PR/DIN and PR/3	BT005
BT/3-BTO for PR/3 only	BT003-BT007

Type	Cat. No.
-	-
PFX/240/2 poles	PX242
PFX/240/3 poles	PX243
-	-
-	-
-	-
-	-
-	-
-	-
-	-
-	-
-	-
-	-
ACI121213	Z121213
ACI121024	Z121024
CNU/8/51	NU0851
-	-
BTU for PR/DIN and PR/3	BT005
BT/3-BTO for PR/3 only	BT003-BT007

GPM Series high current terminal blocks

- mounting for both PR/DIN and PR/3 rails which meet IEC 60715 norms, "G32" and TH/35 types
- nominal voltage 1000 V
- panel mount version - M6 screws (recommended with screwdriver and washer slot)
- possibility of parallel cross connection
- available in beige and grey
- **CESI 13 ATEX 038U** certificate
I M2 Ex e I Mb
II 2G Ex e IIC Gb temperature range of use
-40 – +80°C
- **CoC IEC Ex CES 13.0012U**
- maximum continual operating temperature 100°C



standard version

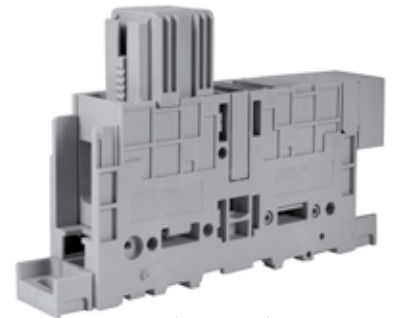

panel-mount version

standard version	GPM.95/BC Cat. No. GP200	GPM.150/BC Cat. No. GP500	GPM.240/BC Cat. No. GP800
grey version	GPM.95/BC/GR Cat. No. GP200GR	GPM.150/BC/GR Cat. No. GP500GR	GPM.240/BC/GR Cat. No. GP800GR
panel-mount version	GPM.95/BC/FIX Cat. No. GP210	GPM.150/BC/FIX Cat. No. GP510	GPM.150/BC/FIX Cat. No. GP810
panel-mount version	GPM.95/BC/FIX/GR Cat. No. GP210GR	GPM.150/BC/FIX/GR Cat. No. GP510GR	GPM.240/BC/FIX/GR Cat. No. GP810GR

TECHNICAL CHARACTERISTICS

function/type	standard version	standard version	standard version
rated cross-section (mm²)	95/150	150/240	240/300
connecting capacity			
flexible (mm²)	35 – 120	50 – 185	95 – 300
rigid (mm²)	25 – 120	35 – 185	95 – 300
bars and/or cable lugs	22 mm maximum width (M8 bolt)	32 mm maximum width (M10 bolt)	40 mm maximum width (M12 bolt)
rated voltage / rated current / gauge conf. to IEC 60947-7-1	1000 V / 232 A / B12	1000 V / 309 A / B14	1000 V / 415 A / B16
rated voltage / rated current / AWG UL	-	-	-
maximum current	320A	440A	600A
rated impulse withstand voltage / pollution degree	12 KV / 3	12 KV / 3	12 KV / 3
insulation stripping length (mm)	35	35	43
tightening torque value - bar (test / recommended) (Nm)	6 / 9 (13 mm wrench)	10 / 15 (key 17 mm)	14 / 21 (key 19 mm)
tightening torque value - cable (test / recommended) (Nm)	6 / 9 (Allen screw, 6 mm wrench)	10 / 15 (Allen screw, 8 mm wrench)	14 / 21 (Allen screw, 8 mm wrench)
height / width / thickness	113 / 158 / 32	134 / 170 / 42	150 / 202 / 52
height / width / thickness	TH/35 7.5 mm	141 / 170 / 42	157 / 202 / 52
height / width / thickness	TH/35 15 mm	138 / 170 / 42	154 / 202 / 52
height / width / thickness	G32	129 / 187 (158) / 42	144 / 219 (172) / 52
height / width (fixing distance between centres) / thickness (panel mount)	108 / 175 (158) / 32		

APPROVALS	standard version	standard version	standard version
	KEMA EAC Ex Terna LV 27/7	KEMA EAC Ex Terna LV 27/7	KEMA EAC Ex Terna LV 27/7

ACCESSORIES	standard version	standard version	standard version
End sections	beige	-	-
Permanent cross connection			
POF/95/2 poles	P0952	PFX/150/2 poles	PX152
POF/95/3 poles	P0953	PFX/150/3 poles	PX153
Switchable cross connection	-	-	-
Multiple common bar	250 mm	-	-
Shunting screw and sleeve	-	-	-
Coloured partition	red, green, white	-	-
Cross connection barrier	red	-	-
Test plug socket	-	-	-
Test plug	-	-	-
Numbering strip	-	-	-
Cover for cross-connection	-	-	-
Mounting rail support	flat for PR/DIN and PR/3 sloped for PR/DIN and PR/3	ACI121213 Z121213 ACI121024 Z121024	ACI121213 Z121213 ACI121024 Z121024
Marking tag	printed or blank	CNU/8/51 NU0851	CNU/8/51 NU0851
End bracket		BTU for PR/DIN and PR/3 BT005 CDA/BT for PR/DIN only CD003 BT/3-BTO for PR/3 only BT003-BT007	BTU for PR/DIN and PR/3 BT005 CDA/BT for PR/DIN only CD003 BT/3-BTO for PR/3 only BT003-BT007

GPM Series high current terminal blocks

- mounting for both PR/DIN and PR/3 rails which meet IEC 60715 norms, "G32" and TH/35 types
- nominal voltage 1000 V
- panel mount version - M6 screws (recommended with screwdriver and washer slot)
- possibility of parallel cross connection
- available in beige RAL 1001
- **CESI 13 ATEX 038U** certificate
I M2 Ex e I Mb
II 2G Ex e IIC Gb temperature range of use
-40 – +80°C
- **CoC IEC Ex CES 13.0012U**
- maximum continual operating temperature 100°C



standard version

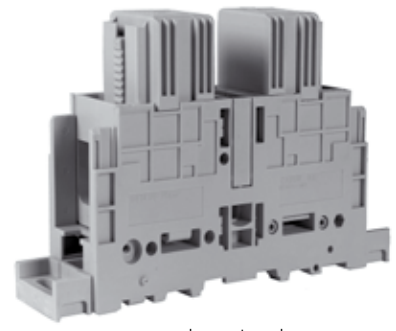

panel-mount version

standard version	GPM.95/CC Cat. No. GP300	GPM.150/CC Cat. No. GP600	GPM.240/CC Cat. No. GP900
grey version	GPM.95/CC/GR Cat. No. GP300GR	GPM.150/CC/GR Cat. No. GP600GR	GPM.240/CC/GR Cat. No. GP900GR
panel-mount version	GPM.95/CC/FIX Cat. No. GP310	GPM.150/CC/FIX Cat. No. GP610	GPM.240/CC/FIX Cat. No. GP910
panel-mount version	GPM.95/CC/FIX/GR Cat. No. GP310GR	GPM.150/CC/FIX/GR Cat. No. GP610GR	GPM.240/CC/FIX/GR Cat. No. GP910GR

TECHNICAL CHARACTERISTICS

	standard version	panel-mount version	panel-mount version
function/type	feed-through	feed-through	feed-through
rated cross-section (mm²)	95	150	240
connecting capacity			
flexible (mm²)	35 – 120	50 – 185	95 – 300
rigid (mm²)	25 – 120	35 – 185	95 – 300
bars and/or cable lugs	22 mm maximum width (M8 bolt)	32 mm maximum width (M10 bolt)	40 mm maximum width (M12 bolt)
rated voltage / rated current / gauge conf. to IEC 60947-7-1	1000 V / 232 A / B12	1000 V / 309 A / B14	1000 V / 415 A / B16
rated voltage / rated current / AWG UL	-	-	-
maximum current	320A	440A	600A
rated impulse withstand voltage / pollution degree	12 KV / 3	12 KV / 3	12 KV / 3
insulation stripping length (mm)	-	-	-
tightening torque value - bar (test / recommended) (Nm)	-	-	-
tightening torque value - cable (test / recommended) (Nm)	6 / 9 (Allen screw, 6 mm wrench)	10 / 15 (Allen screw, 8 mm wrench)	14 / 21 (Allen screw, 8 mm wrench)
height / width / thickness	113 / 140 / 32	134 / 140 / 42	150 / 154 / 52
height / width / thickness	120 / 140 / 32	141 / 140 / 42	157 / 154 / 52
height / width / thickness	117 / 140 / 32	138 / 140 / 42	154 / 154 / 52
height / width (fixing distance between centres) / thickness (panel mount)	108 / 173 (158) / 32	129 / 173 (158) / 42	144 / 187 (172) / 52

APPROVALS	standard version	panel-mount version	panel-mount version

ACCESSORIES	standard version	panel-mount version	panel-mount version
End sections	beige	-	-
Permanent cross connection			
	POF/95/2 poles P0952	PFX/150/2 poles PX152	PFX/240/2 poles PX242
	POF/95/3 poles P0953	PFX/150/3 poles PX153	PFX/240/3 poles PX243
Switchable cross connection	-	-	-
Multiple common bar	250 mm	-	-
Shunting screw and sleeve	-	-	-
Coloured partition	red, green, white	-	-
Cross connection barrier	red	-	-
Test plug socket	-	-	-
Test plug	-	-	-
Numbering strip	-	-	-
Cover for cross-connection	-	-	-
Mounting rail support	flat for PR/DIN and PR/3 sloped for PR/DIN and PR/3	ACI121213 Z121213 ACI121024 Z121024	ACI121213 Z121213 ACI121024 Z121024
Marking tag	printed or blank	CNU/8/51 NU0851	CNU/8/51 NU0851
End bracket		BTU for PR/DIN and PR/3 BT005 CDA/BT for PR/DIN only CD003 BT/3-BTO for PR/3 only BT003-BT007	BTU for PR/DIN and PR/3 BT005 CDA/BT for PR/DIN only CD003 BT/3-BTO for PR/3 only BT003-BT007

ACB Series high current terminal blocks



- to be mounted onto PR/DIN type rails according to IEC 60715 Std., "G32" type
- available in beige
- maximum continual operating temperature 100°C

(*) referred to version equipped with wire clamping collar
(**) tightening with screwdriver / wrench

When using bars or lugs having a width exceeding the indicated value (up to a maximum of 34 mm) the use of SPS separating diaphragms is necessary in order to guarantee the appropriate insulation.

standard version	ACB.70/BB Cat. No. AC100	ACB.120/BB Cat. No. AC400	ACB.185/BB Cat. No. AC700
(Ex) version			
TECHNICAL CHARACTERISTICS			
function/type	feed-through	feed-through	feed-through
rated cross-section (mm ²)	70	120	185
connecting capacity (*)			
flexible (mm ²)	10 – 120	25 – 185	25 – 185
rigid (mm ²)	6 – 120	25 – 185	25 – 185
bars and/or cable lugs	25 mm maximum width (M6 bolt)	25 mm maximum width (M8 bolt)	25 mm maximum width (M12 bolt)
rated voltage / rated current / gauge conf. to IEC 60947-7-1	800 V / 192 A / -	800 V / 269 A / -	800 V / 353 A / -
rated voltage / rated current / AWG UL	-	-	-
rated impulse withstand voltage / pollution degree	8 KV / 3	8 KV / 3	8 KV / 3
insulation stripping length (mm)	-	-	-
tightening torque value / bar (Nm)	- / 3 (key 10 mm)	- / 6 (key 13 mm)	- / 14 (key 19 mm)
tightening torque value / cable (**) (Nm)	-	-	-
height / width / thickness at G32	45 / 90 / 35	46 / 100 / 35	47 / 120 / 35

APPROVALS

ACCESSORIES	Type	Cat. No.	Type	Cat. No.	Type	Cat. No.
Spare clamping collar (to allow the connection of non pre-assembled cables)	ACB.70/CO	AC104	ACB.120/CO	AC404	ACB.185/CO	AC705
Safety cover	PRT/P	PRT01	PRT/P	PRT01	PRT/P	PRT01
	PRT/G	PRT03	PRT/G	PRT03	PRT/G	PRT03
Cover support	SPS/1	SPS01	SPS/1	SPS01	SPS/3	SPS03
Marking tag printed or blank	CNU/8/51	NU0851	CNU/8/51	NU0851	CNU/8/51	NU0851
	-	-	-	-	-	-
End bracket	BTU for PR/DIN and PR/3	BT005	BTU for PR/DIN and PR/3	BT005	BTU for PR/DIN and PR/3	BT005
	CDA/BT for PR/DIN only	CD003	CDA/BT for PR/DIN only	CD003	CDA/BT for PR/DIN only	CD003
	-	-	-	-	-	-

Protection: ACB terminal blocks can be protected against direct and/or accidental contacts by means of specific **PRT** covers of different sizes: Small, Medium or Large in transparent and self-extinguishing material. These covers, with a fixed length of 200 mm, correspond to the width of four terminal blocks side-by-side and inserted on **SPS** supports, also made of self-extinguishing material, which enable the protection of one of the two connections of the terminal blocks; the complete protection of the terminal board is obtained using two covers, overlappable.

PRT/P+SPS/1

- for ACB.70/BB and ACB.120/BB terminal blocks

PRT/M+SPS/5

- for ACB.70 and ACB.120 terminal blocks with clamping collar mounted

PRT/P+SPS/3

- for ACB.185/BB terminal blocks

PRT/M+SPS/7

- for ACB.185 terminal blocks with clamping collar mounted

The **PRT/G** is to be used when the conductors come from the backboard, or in order to protect a connection point not yet connected.



MBL Series stud-type terminal blocks

- stud connection, for cable lugs
- mounted onto PR/DIN profiles conforming to IEC 60715 standards, "G32" type
- available in beige
- maximum continual operating temperature 100°C



standard version

(Ex)i version

TECHNICAL CHARACTERISTICS

function/type	
rated cross-section	(mm ²)
connecting capacity	
flexible	(mm ²)
rigid	(mm ²)
stud diameter / key / locking bolt wrench	
max lug overlapping connection height	(mm)
torque value	
rated voltage / rated current	conf. to IEC 60947-7-1
rated voltage / rated current / AWG	UL
rated impulse withstand voltage / pollution degree	
maximum connectable width	(mm)
height / width / thickness	TH/35 7.5 mm
height / width / thickness	TH/35 15 mm
height / width / thickness	G32

APPROVALS

ACCESSORIES

Partition	
Cover support	
Safety cover	
Marking tag	printed or blank
End bracket	

MBL.50/6

Cat. No. **MB100**

for cable lugs	
50	
30 – 50	
30 – 70	
M 6 / M 10 / M 19	
15.3	
3	
800 V / 150 A	
600 V / 150 A / -	
8 KV / 3	
30	
-	
-	
79 / 39 / 35	



MBL.95/8

Cat. No. **MB200**

for cable lugs	
95	
30 – 95	
30 – 120	
M 8 / M 13 / M 19	
13	
6	
800 V / 232 A	
600 V / 200 A / -	
8 KV / 3	
30	
-	
-	
79 / 39 / 35	



Stud terminal blocks for the terminal wire or bar strain clamp with max. width 30 mm, to be mounted on PR/DIN mounting rail. It is advisable to use **DUS/1** or **DUS/3** barriers to guarantee the insulation distance between different phases.

If accident prevention cover of the terminal board becomes necessary, the insulation function would be performed by the **SPS/5** supports of the cover itself.



Type

DUS/1	DUS01
SPS/5	SPS05
PRT/P	PRT01
CNU/8/51	NU0851
-	
CDA/BT	CD003
-	
-	





Type

DUS/1	DUS01
SPS/5	SPS05
PRT/P	PRT01
CNU/8/51	NU0851
-	
CDA/BT	CD003
-	
-	

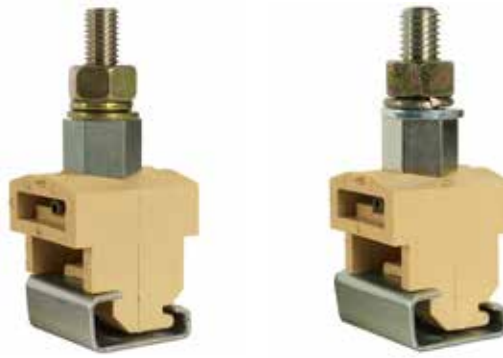
MBL Series stud-type terminal blocks

- stud connection, for cable lugs
- to be mounted onto PR/DIN type rails according to IEC 60715 Std., "G32" type
- available in beige
- maximum continual operating temperature 100°C



standard version	MBL.120/10 Cat. No. MB300	MBL.150/12 Cat. No. MB400
(Ex)i version		
TECHNICAL CHARACTERISTICS		
function/type	for cable lugs	for cable lugs
rated cross-section (mm ²)	120	150
connecting capacity		
flexible (mm ²)	30 – 120	30 – 150
rigid (mm ²)	30 – 150	30 – 185
stud diameter / key / locking bolt wrench	M 10 / M 13 / M 19	M 12 / M 19 / M 19
max lug overlapping connection height (mm)	13	15.8
torque value	10	14
rated voltage / rated current conf. to IEC 60947-7-1	800 V / 269 A	800 V / 309 A
rated voltage / rated current / AWG UL	600 V / 230 A / -	600 V / 285 A / -
rated impulse withstand voltage / pollution degree	8 kV / 3	8 kV / 3
maximum connectable width (mm)	30	30
height / width / thickness 	-	-
height / width / thickness 	-	-
height / width / thickness 	90 / 39 / 35	90 / 39 / 35
APPROVALS		
ACCESSORIES	Type	Type
Partition	DUS/3 DUS03	DUS/3 DUS03
Cover support	SPS/5 SPS05	SPS/5 SPS05
Safety cover	PRT/P PRT01	PRT/P PRT01
Marking tag printed or blank	CNU/8/51 NU0851	CNU/8/51 NU0851
End bracket	CDA/BT CD003	CDA/BT CD003
	-	-
	-	-

Earth terminal blocks

- mounted onto PR/3 profiles conforming to IEC 60715 standards, TH/35 and "G32" type
- in a single yellow/green shell
- certificate **CESI 02 ATEX 061 U Ex e** I M2 / II 2 G D temperature range of use: -40 – +80°C
- **CoC IEC Ex CES 09.0010U Ex e II**
- maximum continual operating temperature 100°C



(*) with reference to upper and lower clamping units respectively

version to be mounted onto PR/3 rail	TE0.2 Cat. No. T0910	CBE.2 Cat. No. CE110	TE0.4 Cat. No. T0430
TECHNICAL CHARACTERISTICS			
function/type	earth	earth (2 inputs / 2 outputs)	earth
rated cross-section (mm ²)	2.5	2.5	4
connecting capacity			
flexible (mm ²)	0.2 – 4	0.2 – 4	0.2 – 6
rigid (mm ²)	0.2 – 4	0.2 – 4	0.2 – 6
max. flexible with ferrule (mm) - ferrule type	2.5 - WP25/14	2.5 - WP25/14	4 - WP40/16
rated voltage / rated current / gauge conf. to IEC 60947-7-1	- / - / A3	- / - / A3	- / - / A4
rated voltage / rated current / AWG / tightening torque value UL (Ex e) rated voltage / (V)	- / - / 20-14 AWG / 5.5 lb.in.	- / 15 A / 20 – 14 AWG / 5.5 lb.in.	- / - / 20 – 12 AWG / 5.5 lb.in.
rated impulse withstand voltage / pollution degree	8 KV / 3	8 KV / 3	8 KV / 3
insulation stripping length (mm)	12	8 - 14,5 (*)	14
tightening torque value (test / max) (Nm)	0.4 / 0.8	0.4 / 0.5	0.5 / 1.2
height / width / thickness TH/35 7.5 mm	47 / 50 / 5.5	52 / 50 / 5	52 / 50 / 6.5
height / width / thickness TH/35 15 mm	55 / 50 / 5.5	60 / 50 / 5	60 / 50 / 6.5
height / width / thickness G32	-	56 / 50 / 5	-
APPROVALS			
ACCESSORIES			
End section green	Type TE0.2/PT Cat. No. T0911	Type CBR/PT Cat. No. CR111	Type TE0.4/PT Cat. No. T0431
Marking tag printed or blank	CNU/8/51 NU0851	CNU/8/51 NU0851	CNU/8/51 NU0851
Numbering strip	-	CNU/8/51 NU0851	-
End bracket	BTU for PR/DIN and PR/3 BT005 BT/3-BT0 for PR/3 only BT003-BT007	BTU for PR/DIN and PR/3 BT005 BT/3-BT0 for PR/3 only BT003-BT007 BT/DIN/PO for PR/DIN only BT001	BTU for PR/DIN and PR/3 BT005 BT/3-BT0 for PR/3 only BT003-BT007

MAXIMUM SHORT-TIME WITHSTAND CURRENTS ALLOCATED TO THE RAIL PROFILE				
Rail profile	Material	Equivalent E-cu cross-section mm ²	Short-time withstand current 1 s kA	Thermal rated current of a PEN busbar A
"Top hat" rail IEC 60715/TH 15 - 5.5	Steel	10	1.2	-
	Copper	25	3	101
	Aluminium	16	1.92	76
"Top hat" rail IEC 60715/TH 35 - 7.5	Steel	16	1.92	-
	Copper	50	6	150
	Aluminium	35	4.2	125
"Top hat" rail IEC 60715/TH 35 - 15	Steel	50	6	-
	Copper	150	18	309
	Aluminium	95	11.4	232

Earth terminal blocks

- mounted onto PR/3 profiles conforming to IEC 60715 standards, TH/35 type
- mounted onto PR/DIN profiles conforming to IEC 60715 standards, "G32" type
- in two yellow/green shells
- certificate **CESI 02 ATEX 061 U Ex e** I M2 / II 2 G D temperature range of use: -40 – +80°C
- **CoC IEC Ex CES 09.0010U Ex e II**
- maximum continual operating temperature 100°C



version to be mounted onto PR/3 rail	TE.6/O	Cat. No.	T0110	TE.10/O	Cat. No.	T0500			
version to be mounted onto PR/DIN rail	TED.4	Cat. No.	TE400	TE.6/D	Cat. No.	TE110	TE.10/D	Cat. No.	TE500
TECHNICAL CHARACTERISTICS									
function/type	earth	earth	earth	earth	earth	earth	earth	earth	earth
rated cross-section (mm ²)	4	6	10	4	6	10	4	6	10
connecting capacity									
flexible (mm ²)	0.2 – 6	0.5 – 10	0.5 – 16	0.2 – 6	0.5 – 10	0.5 – 16	0.2 – 6	0.5 – 10	0.5 – 16
rigid (mm ²)	0.2 – 6	0.5 – 10	0.5 – 16	0.2 – 6	0.5 – 10	0.5 – 16	0.2 – 6	0.5 – 10	0.5 – 16
max. flexible with ferrule (mm ²) - ferrule type	4 - WP40/16	6 - WP60/20	10 - WP100/21	4 - WP40/16	6 - WP60/20	10 - WP100/21	4 - WP40/16	6 - WP60/20	10 - WP100/21
rated voltage / rated current / gauge conf. to IEC 60947-7-1	- / - / A4	- / - / A5	- / - / B6	- / - / A4	- / - / A5	- / - / B6	- / - / A4	- / - / A5	- / - / B6
rated voltage / rated current / AWG / tightening torque value UL (Ex e) rated voltage / (V)	- / - / 20-12 AWG / 5.5 lb.in.	- / - / 20-8 AWG / 13.3 lb.in	- / - / 20-8 AWG Str. / 13.3 lb.in	- / - / 20-12 AWG / 5.5 lb.in.	- / - / 20-8 AWG / 13.3 lb.in	- / - / 20-8 AWG Str. / 13.3 lb.in	- / - / 20-12 AWG / 5.5 lb.in.	- / - / 20-8 AWG / 13.3 lb.in	- / - / 20-8 AWG Str. / 13.3 lb.in
rated impulse withstand voltage / pollution degree	-	-	-	-	-	-	-	-	-
rated impulse withstand voltage / pollution degree	8 KV / 3	8 KV / 3	8 KV / 3	8 KV / 3	8 KV / 3	8 KV / 3	8 KV / 3	8 KV / 3	8 KV / 3
insulation stripping length (mm)	10	12	13	10	12	13	10	12	13
tightening torque value (test / max) (Nm)	0.5 / 1.2	0.8 / 1.4	1.2 / 1.9	0.5 / 1.2	0.8 / 1.4	1.2 / 1.9	0.5 / 1.2	0.8 / 1.4	1.2 / 1.9
height / width / thickness	-	52 / 47 / 8	55 / 47 / 10	-	52 / 47 / 8	55 / 47 / 10	-	52 / 47 / 8	55 / 47 / 10
height / width / thickness	-	60 / 47 / 8	63 / 47 / 10	-	60 / 47 / 8	63 / 47 / 10	-	60 / 47 / 8	63 / 47 / 10
height / width / thickness	56 / 50 / 6.5	53 / 42 / 8	56 / 44 / 10	56 / 50 / 6.5	53 / 42 / 8	56 / 44 / 10	56 / 50 / 6.5	53 / 42 / 8	56 / 44 / 10
APPROVALS									
ACCESSORIES									
End section	green	TEO.4/PT	T0431	-	CNU/8/51	NU0851	-	CNU/8/51	NU0851
Marking tag	printed or blank	CNU/8/51	NU0851	-	-	-	-	-	-
Numbering strip	-	-	-	-	-	-	-	-	-
End bracket	-	BTU for PR/DIN and PR/3	BT005	BTU for PR/DIN and PR/3	BT005	BTU for PR/DIN and PR/3	BT005	BTU for PR/DIN and PR/3	BT005
		BT/3-BTO for PR/3 only	BT003-BT007	BT/DIN/PO for PR/DIN only	BT001	BT/3-BTO for PR/3 only	BT003-BT007	BT/DIN/PO for PR/DIN only	BT001
		BT/DIN/PO for PR/DIN only	BT001	BT/3-BTO for PR/3 only	BT003-BT007	BT/DIN/PO for PR/DIN only	BT001	BT/3-BTO for PR/3 only	BT003-BT007

MAXIMUM SHORT-TIME WITHSTAND CURRENTS ALLOCATED TO THE RAIL PROFILE				
Rail profile	Material	Equivalent E-cu cross-section mm ²	Short-time withstand current 1 s kA	Thermal rated current of a PEN busbar A
"Top hat" rail IEC 60715/TH 15 - 5.5	Steel	10	1.2	-
	Copper	25	3	101
	Aluminium	16	1.92	76
G32 type mounting rail IEC 60715/G32	Steel	35	4.2	-
	Copper	120	14.4	269
	Aluminium	70	8.4	192
"Top hat" rail IEC 60715/TH 35 - 7.5	Steel	16	1.92	-
	Copper	50	6	150
	Aluminium	35	4.2	125
"Top hat" rail IEC 60715/TH 35 - 15	Steel	50	6	-
	Copper	150	18	309
	Aluminium	95	11.4	232

Earth terminal blocks

- mounted onto PR/3 profiles conforming to IEC 60715 standards, TH/35 type
- mounted onto PR/DIN profiles conforming to IEC 60715 standards, "G32" type
- in two yellow/green shells
- certificate **CESI 02 ATEX 061 U Ex e** I M2 / II 2 G D temperature range of use: -40 – +80°C
- **CoC IEC Ex CES 09.0010U Ex e II**
- maximum continual operating temperature 100°C

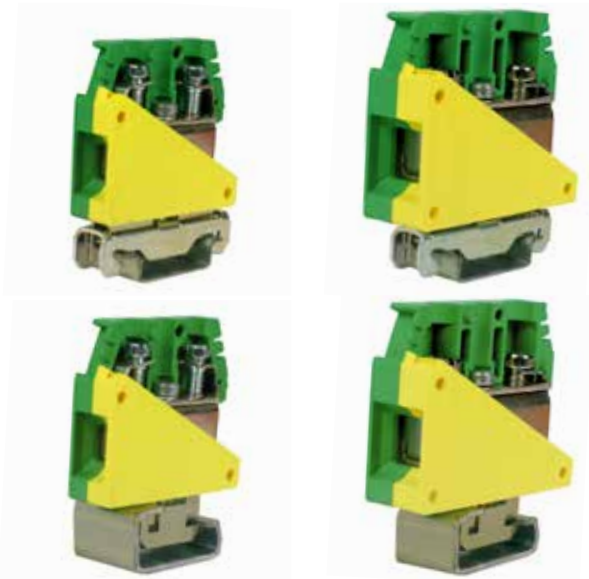

version to be mounted onto PR/3 rail

TE.16/O Cat. No. **T0210**

TE.50/O Cat. No. **T0310**

version to be mounted onto PR/DIN rail

TE.16/D Cat. No. **TE210**

TE.50/D Cat. No. **TE310**

TECHNICAL CHARACTERISTICS

function/type	
rated cross-section	(mm ²)
connecting capacity	
flexible	(mm ²)
rigid	(mm ²)
max. flexible with ferrule (mm ²) - ferrule type	
rated voltage / rated current / gauge conf. to IEC 60947-7-1	
rated voltage / rated current / AWG / tightening torque value UL (Ex e) rated voltage / (V)	
rated impulse withstand voltage / pollution degree	
insulation stripping length	(mm)
tightening torque value (test / max)	(Nm)
height / width / thickness	TH/35 7.5 mm
height / width / thickness	TH/35 15 mm
height / width / thickness	G32

earth	16
connecting capacity	0.5 – 25
flexible	0.5 – 25
rigid	16 - WP160/22
max. flexible with ferrule (mm ²) - ferrule type	- / 76 A / B7
rated voltage / rated current / AWG / tightening torque value UL (Ex e) rated voltage / (V)	- / - / 20-3 AWG / 13.3 lb.in
rated impulse withstand voltage / pollution degree	8 KV / 3
insulation stripping length	13
tightening torque value (test / max)	1.8 / 3
height / width / thickness	56 / 47 / 12
height / width / thickness	64 / 47 / 12
height / width / thickness	57.5 / 46.5 / 12

earth	50
connecting capacity	1.5 – 50
flexible	1 – 70
rigid	50 - WP500/40
max. flexible with ferrule (mm ²) - ferrule type	- / 125 A / B9
rated voltage / rated current / AWG / tightening torque value UL (Ex e) rated voltage / (V)	- / - / 16-1 AWG / 33.2 lb.in
rated impulse withstand voltage / pollution degree	8 KV / 3
insulation stripping length	17
tightening torque value (test / max)	2.5 / 5
height / width / thickness	62 / 57 / 18
height / width / thickness	70 / 57 / 18
height / width / thickness	63 / 57 / 18



APPROVALS

ACCESSORIES

End section	green
Marking tag	printed or blank
Numbering strip	
End bracket	

Type	Cat. No.
-	-
CNU/8/51	NU0851
-	-
BTU for PR/DIN and PR/3	BT005
BT/3-BTO for PR/3 only	BT003-BT007
BT/DIN/PO for PR/DIN only	BT001

Type	Cat. No.
-	-
CNU/8/51	NU0851
-	-
BTU for PR/DIN and PR/3	BT005
BT/3-BTO for PR/3 only	BT003-BT007
BT/DIN/PO for PR/DIN only	BT001

MAXIMUM SHORT-TIME WITHSTAND CURRENTS ALLOCATED TO THE RAIL PROFILE				
Rail profile	Material	Equivalent E-cu cross-section mm ²	Short-time withstand current 1 s kA	Thermal rated current of a PEN busbar A
"Top hat" rail IEC 60715/TH 15 - 5.5	Steel	10	1.2	-
	Copper	25	3	101
	Aluminium	16	1.92	76
G32 type mounting rail IEC 60715/G32	Steel	35	4.2	-
	Copper	120	14.4	269
	Aluminium	70	8.4	192
"Top hat" rail IEC 60715/TH 35 - 7.5	Steel	16	1.92	-
	Copper	50	6	150
	Aluminium	35	4.2	125
"Top hat" rail IEC 60715/TH 35 - 15	Steel	50	6	-
	Copper	150	18	309
	Aluminium	95	11.4	232

Two and three level circuits

- feed-through with 2 levels
- feed-through with 2 levels and internal connection
- available in the standard version (grey and beige) or in a version appropriate for use with "intrinsically safe" (Ex)i circuits (blue)
- mounting on PR/3 rails according IEC 60715, TH/35 type
- certificate **CESI 13 ATEX 038U**
I M2 Ex e I Mb
II 2G Ex e IIC Gb
- 100°C maximum continual operating temperature



(*) between lower levels (with partition)
(**) between upper levels (with partition)
(***) value referred to the characteristics of the terminal block alone, within the temperature range according to IEC 60947-7-1 Std.

The /GR tag indicates the grey version.

grey version	
beige version	
(Ex)i version	
TECHNICAL CHARACTERISTICS	
function/type	
rated cross-section (mm ²)	
connecting capacity	
flexible (mm ²)	
rigid (mm ²)	
max. flexible with ferrule (mm ²) - ferrule type	
rated voltage / rated current / gauge conf. to IEC 60947-7-1	
rated voltage / rated current / AWG / tightening torque value UL	
maximum current (***)	
(Ex e) rated voltage (V)	
rated impulse withstand voltage / pollution degree	
insulation stripping length (mm)	
tightening torque value (test / max) (Nm)	
height / width / thickness TH/35 7,5 mm	
height / width / thickness TH/35 15 mm	

DBC.2/GR	Cat. No. DB100GR
DBC.2	Cat. No. DB100
DBC.2 (Ex)i	Cat. No. DB200

2 level feed-through	
2.5	
0.2 – 4	
0.2 – 4	
2.5 - WP25/14	
630 V / 24 A / A3	
600 V / 20 A / 28-12 AWG / 8 lb.in	
27 A (2.5 mm ²) / 34 A (4 mm ²)	
-	
8 kV / 3	
9	
0.4 / 0.8	
66 / 70 / 5	
74 / 70 / 5	

DBC.2/CI/GR	Cat. No. DB117GR
DBC.2/CI	Cat. No. DB117

2 level feed-through with internal cross-connection	
2.5	
0.2 – 4	
0.2 – 4	
2.5 - WP25/14	
630 V / 24 A / A3	
600 V / 20 A / 28-12 AWG / 8 lb.in	
27 A (2.5 mm ²) / 34 A (4 mm ²)	
-	
8 kV / 3	
9	
0.4 / 0.8	
66 / 70 / 5	
74 / 70 / 5	

APPROVALS



ACCESSORIES	
End sections	grey beige blue
"Easy Bridge" (PTC) cross connection (intrinsically IPXXB protected once mounted) Available also in coloured version (PTP) Ref. p. 130	
Rated current carrying capacity of jumper (A)	
Cross-connection identification strip(100 mm)	green
Switchable cross connection	
Multiple common bar	250 mm
Shunting screw and sleeve	
Coloured partition	red, green, white
Cross connection barrier (upper level)	red
Cross connection barrier (lower level)	red
Test plug socket	
Test plug	
Modular test plug	
End section for modular test plug	
Numbering strip	
Warning plate	on adjacent terminal blocks
Cover for cross-connection	
Marking tag	printed or blank
End bracket	

Type	Cat. No.
DBC/PT/GR	DB101GR
DBC/PT	DB101
DBC/PT (Ex)i	DB201
PTC/2/02 poles	PTC0202
PTC/2/03 poles	PTC0203
PTC/2/05 poles	PTC0205
PTC/2/10 poles	PTC0210
PTC/2/00 (50 poles)	PTC0200
24	
PTC/SP	PTC0990
-	
-	
DFU/7	DU07..
DFM/800 - DFM/900	DF800-900
DFM/500	DF500
-	
-	
CNU/8/51	NU0851
-	
-	
CNU/8/51	NU0851
BTU for PR/DIN and PR/3	BT005
BTO for PR/3 only	BT007

Type	Cat. No.
DBC/PT/GR	DB101GR
DBC/PT	DB101
DBC/PT (Ex)i	DB201
PTC/2/02 poles	PTC0202
PTC/2/03 poles	PTC0203
PTC/2/05 poles	PTC0205
PTC/2/10 poles	PTC0210
PTC/2/00 (50 poles)	PTC0200
24	
PTC/SP	PTC0990
-	
-	
DFU/7	DU07..
DFM/800 - DFM/900	DF800-900
DFM/500	DF500
-	
-	
CNU/8/51	NU0851
-	
-	
CNU/8/51	NU0851
BTU for PR/DIN and PR/3	BT005
BTO for PR/3 only	BT007

Two and three level circuits

- feed-through with 2 levels
- feed-through with 2 levels and internal connection
- suitable for housing components
- mounting on PR/3 rails according IEC 60715, TH/35 type
- available in grey or in a version appropriate for use with "intrinsically safe" circuits (Ex)i
- terminal block DBC.4 certificate **IMQ 17 ATEX 001 U Ex e**
 I M2 Ex eb I Mb / II 2 G Ex eb llc Gb temperature range of use: -40 – +80°C
- **CoC IEC Ex IMQ 17.0001 U**
- four slots for inserting "Easy Bridge" coupling cross connection
- **100°C** maximum continual operating temperature

The /GR tag indicates the grey version.



grey version	
(Ex)i version	
TECHNICAL CHARACTERISTICS	
function/type	
rated cross-section	(mm ²)
connecting capacity	
flexible	(mm ²)
rigid	(mm ²)
max. flexible with ferrule (mm ²) - ferrule type	
rated voltage / rated current / gauge	conf. to IEC 60947-7-1
rated voltage / rated current / AWG / tightening torque value	UL
(Ex e) rated voltage	/ (V)
rated impulse withstand voltage / pollution degree	
insulation stripping length	(mm)
tightening torque value (test / max)	(Nm)
height / width / thickness	TH/35 7,5 mm
height / width / thickness	TH/35 15 mm

DBC.4/GR	Cat. No. DB400GR
DBC.4 (Ex)i	Cat. No. DB500

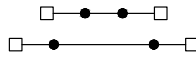

2 level feed-through	
4	
0.2 – 6	
0.2 – 6	
4 - WP40/16	
630 V / 32 A / A4	
600 V / 30 A / 20 -10 AWG / 4.4 lb.in	
-	
8 KV / 3	
9	
0.5 / 1	
66 / 70 / 6	
74 / 70 / 6	



DBC.4/CI/GR	Cat. No. DB417GR
DBC.4/CI (Ex)i	Cat. No. DB517

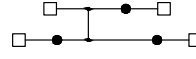

2 level feed-through with internal cross-connection	
4	
0.2 – 6	
0.2 – 6	
4 - WP40/16	
630 V / 32 A / A4	
600 V / 30 A / 20 -10 AWG / 4.4 lb.in	
-	
8 KV / 3	
9	
0.5 / 1	
66 / 70 / 6	
74 / 70 / 6	



APPROVALS

ACCESSORIES	
Grey	blue end section
"Easy Bridge" (PTC) cross connection (intrinsically IPXXB protected once mounted)	
3-pole rated current carrying capacity of jumper - (applic. Ex e)	(A)
Cross-connection identification strip	
Coloured partition	red
Cross connection barrier (upper level)	red
Cross connection barrier (lower level)	red
Marking tag	pitch mounting
	single mounting
End bracket	

Type	Cat. No.
DBC.4/PT/GR	DB401GR
DBC.4/PT (Ex)i	DB402
PTC/4/02	PTC0402
PTC/4/03	PTC0403
PTC/4/05	PTC0405
PTC/4/10	PTC0410
PTC/4/00	PTC0400
32 (25)	
PTC/SP	PT0990
DFU/7R	DU07R
DFM/800-DFM/900	DF800-DF900
DFM/500	DF500
CNU/10/11	NU1061
CNU/8/61	NU0861
CNU/8/51	NU0851
CNU/10/51	NU1051
BTU for PR/DIN and PR/3	BT005
BT/3-BT0 for PR/3 only	BT003-BT007

Type	Cat. No.
DBC.4/PT/GR	DB401GR
DBC.4/PT (Ex)i	DB402
PTC/4/02	PTC0402
PTC/4/03	PTC0403
PTC/4/05	PTC0405
PTC/4/10	PTC0410
PTC/4/00	PTC0400
32 (25)	
PTC/SP	PT0990
DFU/7	DU07R
DFM/800-DFM/900	DF800-DF900
DFM/500	DF500
CNU/10/11	NU1061
CNU/8/61	NU0861
CNU/8/51	NU0851
CNU/10/51	NU1051
BTU for PR/DIN and PR/3	BT005
BT/3-BT0 for PR/3 only	BT003-BT007

Two and three level circuits

- feed-through with 2 levels
- feed-through with 2 levels and internal connection
- available in the standard version (beige) or in a version appropriate for use with "intrinsically safe" (Ex)i circuits (blue)
- universal mounting on mounting rails in accordance with IEC 60715 standard
- terminal block DAS.4 certificate **CESI 03 ATEX 162 U**
Ex e (Ex) I M2 / II 2 G D temperature range of use: -40 – +80°C
- **CoC IEC Ex CES 11.0007 U** Ex e II
- maximum continual operating temperature 100°C

The **/GR** tag indicates the grey version.



- for creating terminal boards in a potentially explosive environment (Ex e) see the indications on page A14

grey version	
beige version	
(Ex)i version	
TECHNICAL CHARACTERISTICS	
function/type	
rated cross-section	(mm ²)
connecting capacity	
flexible	(mm ²)
rigid	(mm ²)
max. flexible with ferrule (mm ²) - ferrule type	
rated voltage / rated current / gauge	conf. to IEC 60947-7-1
rated voltage / rated current / AWG / tightening torque value	UL
(Ex e) rated voltage	(V)
rated impulse withstand voltage / pollution degree	
insulation stripping length	(mm)
tightening torque value (test / max)	(Nm)
height / width / thickness	TH/35 7.5 mm
height / width / thickness	TH/35 15 mm
height / width / thickness	G32

DAS.4/GR	
Cat. No.	DS100GR
DAS.4	
Cat. No.	DS100
DAS.4 (Ex)i	
Cat. No.	DS200

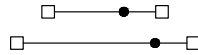

2 level feed-through	4
connecting capacity	
flexible	0.2 – 6
rigid	0.2 – 6
max. flexible with ferrule (mm ²) - ferrule type	4 - WP40/16
rated voltage / rated current / gauge	630 V / 30 A / A4
rated voltage / rated current / AWG / tightening torque value	600 V / 20 A / 20-12 AWG / 8.9 lb.in
(Ex e) rated voltage	400 / 400
rated impulse withstand voltage / pollution degree	8 KV / 3
insulation stripping length	9
tightening torque value (test / max)	0.5 / 1.2
height / width / thickness	62 / 64 / 6
height / width / thickness	70 / 64 / 6
height / width / thickness	66 / 64 / 6



DAS.4/CI/GR	
Cat. No.	DS117GR
DAS.4/CI	
Cat. No.	DS117
DAS.4/CI (Ex)i	
Cat. No.	DS217

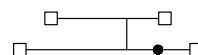

feed-through with internal jumper mounted	4
connecting capacity	
flexible	0.2 – 6
rigid	0.2 – 6
max. flexible with ferrule (mm ²) - ferrule type	4 - WP40/16
rated voltage / rated current / gauge	630 V / 30 A / A4
rated voltage / rated current / AWG / tightening torque value	600 V / 20 A / 20-12 AWG / 8.9 lb.in
(Ex e) rated voltage	-
rated impulse withstand voltage / pollution degree	8 KV / 3
insulation stripping length	9
tightening torque value (test / max)	0.5 / 1.2
height / width / thickness	62 / 64 / 6
height / width / thickness	70 / 64 / 6
height / width / thickness	66 / 64 / 6



APPROVALS

ACCESSORIES	
Grey	beige end section blue
Permanent cross connection	
Rated current carrying capacity of jumper	(A)
Cross-connection identification strip(100 mm)	green
Switchable cross connection	
Multiple common bar	250 mm
Shunting screw and sleeve (same, Ex e version)	
Coloured partition	red, green, white
Cross connection barrier	red
Test plug socket	
Test plug	
Modular test plug	
End section for modular test plug	
Numbering strip	
Shunting screw and sleeve	internal jumper internal jumper + external jumper
Cover for cross-connection	
Marking tag	printed or blank
End bracket	

Type	Cat. No.
DAS/PT/GR	DS101GR
DAS/PT	DS101
DAS/PT (Ex)i	DS201
PM/41/2 poles	PM412
PM/51/3 poles	PM513
PM/51/5 poles	PM515
PM/51/10 poles	PM510
30	
POS/43	POS43
PMP/58	PMP58
CPM/01 (CPX/01)	CPM01 (CPX01)
DFU/7	DU07..
PSD/A	PD001
SDD/1	DD001
CNU/8/61	NU0861
DAS/VCI	DS107
DAS/VCE	DS108
PRP/5	PRP05
CNU/8/61	NU0861
BTU for PR/DIN and PR/3	BT005
BT/DIN/PO for PR/DIN only	BT001
BT/3-BTO for PR/3 only	BT003-BT007

Type	Cat. No.
DAS/PT/GR	DS101GR
DAS/PT	DS101
DAS/PT (Ex)i	DS201
PM/41/2 poles	PM412
PM/51/3 poles	PM513
PM/51/5 poles	PM515
PM/51/10 poles	PM510
30	
POS/43	POS43
PMP/58	PMP58
CPM/01 (CPX/01)	CPM01 (CPX01)
DFU/7	DU07..
PSD/A	PD001
SDD/1	DD001
CNU/8/61	NU0861
DAS/VCE	DS108
PRP/5	PRP05
CNU/8/61	NU0861
BTU for PR/DIN and PR/3	BT005
BT/DIN/PO for PR/DIN only	BT001
BT/3-BTO for PR/3 only	BT003-BT007

Two and three level circuits

- feed-through with solder lug
- with switchable upper circuit
- universal mounting for both PR/DIN and PR/3 rails which meet IEC 60715 norms, "G32" and TH/35 types
- available in beige and grey
- maximum continual operating temperature 100°C



with 2.8 x 0.8 mm solder lugs



Please, see page 136 (table) to determine the insulation voltage of the different PTC connection diagrams

The /GR tag indicates the grey version.

grey version	
beige version	
(Ex)i version	
TECHNICAL CHARACTERISTICS	
function/type	
rated cross-section	(mm ²)
connecting capacity	
flexible	(mm ²)
rigid	(mm ²)
max. flexible with ferrule (mm ²) - ferrule type	
rated voltage / rated current / gauge	conf. to IEC 60947-7-1
rated voltage / rated current / AWG / tightening torque value	UL
(Ex e) rated voltage	[] / [] (V)
rated impulse withstand voltage / pollution degree	
insulation stripping length	(mm)
tightening torque value (test / max)	(Nm)
height / width / thickness	[] TH/35 7,5 mm
height / width / thickness	[] TH/35 15 mm
height / width / thickness	[] G32

(*) value referred to the staggered position of solder lugs
 (**) max. on lug

(***) referring respectively to upper and lower levels

DAS.4/SS/GR	Cat. No. DS110GR
DAS.4/SS	Cat. No. DS110

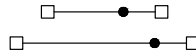

feed-through with solder lugs	4
0.2 - 6	0.2 - 6
4 - WP40/16	4 - WP40/16
320 V - 500 V (*) / 20 A (**) / A4	-
4 kV / 3	9
0.5 / 1.2	62 / 80 / 6
	70 / 80 / 6
	66 / 80 / 6

DSS.4/GR	Cat. No. DS400GR
DSS.4	Cat. No. DS400

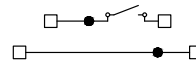

with upper disconnect level	4
0.2 - 6	0.2 - 6
4 - WP40/16	4 - WP40/16
400 V / 24-32 (***) / A4	300 V / 24-32 A / 26-10 AWG / 4.4 lb.in
6 kV / 3	9
0.5 / 1.2	62 / 78 / 6
	70 / 78 / 6
	66 / 78 / 6



terminal block type DSS.4 with lever up and PTC/4 cross connections inserted on both levels.

APPROVALS



ACCESSORIES	
End sections	grey beige blue
"Easy Bridge" (PTC) cross connection (intrinsically IPXXB protected once mounted) Available also in coloured version (PTP) Ref. p. 130	
Rated current carrying capacity of jumper	(A)
Cross-connection identification strip(100 mm)	green
Switchable cross connection	
Multiple common bar	250 mm
Shunting screw and sleeve	
Coloured partition	red, green, white
Cross connection barrier	red
Test plug socket	
Test plug	
Modular test plug	
End section for modular test plug	
Numbering strip	
Fuse	
Cover for cross-connection	
Marking tag	printed or blank
End bracket	

Type	Cat. No.
DAS/PT/GR	DS101GR
DAS/PT	DS101
PM/41/2 poles	PM412
PM/51/3 poles	PM513
PM/51/5 poles	PM515
PM/51/10 poles	PM510
32	-
POS/43	POS43
PMP/58	PMP58
CPM/01 (CPX/01)	CPM01 (CPX01)
DFU/7	DU07..
PSD/A	PD001
SDD/1	DD001
CNU/8/61	NU0861
PRP/5	PRP05
CNU/8/51	NU0851
BTU for PR/DIN and PR/3	BT005
BT/DIN/PO for PR/DIN only	BT001
BT/3 for PR/3 only	BT003

Type	Cat. No.
DSS/PT/GR	DS301GR
DSS/PT	DS301
PTC/4/02 poles (*)	PTC0402
PTC/4/03 poles (*)	PTC0403
PTC/4/05 poles (*)	PTC0405
PTC/4/10 poles (*)	PTC0410
PTC/4/00 (42 poles) (*)	PTC0400
32	-
PTC/SP	PTC0990
DFU/7	DU07..
DFM/500	DF500
CNU/8/61	NU0861
CNU/8/51	NU0851
BTU for PR/DIN and PR/3	BT005
BT/DIN/PO for PR/DIN only	BT001
BT/3-BTO for PR/3 only	BT003-BT007

Two and three level circuits

- with flat plug connections
- universal mounting for both PR/DIN and PR/3 rails which meet IEC 60715 norms, "G32" and TH/35 types
- available in beige and grey
- maximum continual operating temperature 100°C



Flat plug terminals, 6.3 x 0.8 mm, or 2.8 x 0.8 mm, compliant with the IEC 60760 Standard



FVS/VCI - Cat. No. FV107
Shunting screws and sleeves for internal connection between the front and rear conducting bodies of terminal block type FVS.4



FVS/VCE - Code FV108
Screw and sleeve which, besides the internal connection, creates, using the PMP common bar, parallel between contiguous terminal blocks

The **/GR** tag indicates the grey version.

grey version
beige version
(Ex)i version

TECHNICAL CHARACTERISTICS

function/type	
rated cross-section	(mm ²)
connecting capacity	
flexible	(mm ²)
rigid	(mm ²)
max. flexible with ferrule (mm ²) - ferrule type	
rated voltage / rated current / gauge	conf. to IEC 60947-7-1
rated voltage / rated current / AWG / tightening torque value	UL
(Ex e) rated voltage	(V)
rated impulse withstand voltage / pollution degree	
insulation stripping length	(mm)
tightening torque value (test / max)	(Nm)
height / width / thickness	TH/35 7.5 mm
height / width / thickness	TH/35 15 mm
height / width / thickness	G32

FVS.4/GR	Cat. No. FV100GR
FVS.4	Cat. No. FV100

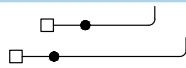

for overlapped circuits	4
flexible	0.2 - 6
rigid	0.2 - 6
max. flexible with ferrule (mm ²) - ferrule type	4 - WP40/16
rated voltage / rated current / gauge	320 V / 20 A / A4
rated voltage / rated current / AWG / tightening torque value	600 V / 20 A / 20-10 AWG / 8.9 lb.in.
(Ex e) rated voltage	-
rated impulse withstand voltage / pollution degree	6 kV / 3
insulation stripping length	12
tightening torque value (test / max)	0.8 / 1.2
height / width / thickness	69 / 64 / 6.5
height / width / thickness	77 / 64 / 6.5
height / width / thickness	73 / 64 / 6.5

FFS.4/GR	Cat. No. FF100GR
FFS.4	Cat. No. FF100

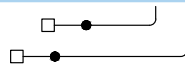

for overlapped circuits in staggered position	4
flexible	0.2 - 6
rigid	0.2 - 6
max. flexible with ferrule (mm ²) - ferrule type	4 - WP40/16
rated voltage / rated current / gauge	320 V / 20 A / A4
rated voltage / rated current / AWG / tightening torque value	600 V / 20 A / 20-10 AWG / 8.9 lb.in.
(Ex e) rated voltage	-
rated impulse withstand voltage / pollution degree	6 kV / 3
insulation stripping length	12
tightening torque value (test / max)	0.8 / 1.2
height / width / thickness	69 / 64 / 6.5
height / width / thickness	77 / 64 / 6.5
height / width / thickness	73 / 64 / 6.5

APPROVALS



ACCESSORIES

End sections	grey beige blue
Permanent cross connection	
Rated current carrying capacity of jumper	(A)
Switchable cross connection	
Multiple common bar	250 mm
Shunting screw and sleeve	
Coloured partition	red, green, white
Cross connection barrier	red
Test plug socket	
Test plug	
Modular test plug	
End section for modular test plug	
Numbering strip	
Shunting screw and sleeve	
Cover for cross-connection	
Marking tag	printed or blank
End bracket	

Type	Cat. No.
FVS/PT/GR	FV101GR
FVS/PT	FV101
32	
POS/72	POS72
PMP/02	PMP02
CPM/01 (CPX/01)	CPM01 (CPX01)
DFU/6	DU06..
PSD/A	PD001
SDD/1	DD001
FVS/VCI	FV107
FVS/VCE	FV108
PRP/6	PRP06
CNU/8/51	NU0851
BTU for PR/DIN and PR/3	BT005
BT/DIN/PO for PR/DIN only	BT001
BT/3-BTO for PR/3 only	BT003-BT007

Type	Cat. No.
FFS/PT/GR	FF101GR
FFS/PT	FF101
32	
POS/72	POS72
PMP/02	PMP02
CPM/01 (CPX/01)	CPM01 (CPX01)
PSD/A	PD001
SDD/1	DD001
PRP/6	PRP06
CNU/8/51	NU0851
BTU for PR/DIN and PR/3	BT005
BT/DIN/PO for PR/DIN only	BT001
BT/3-BTO for PR/3 only	BT003-BT007

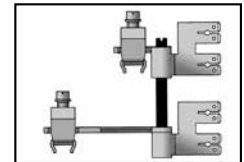

VCI

internal cross connection

PMP bar
(to be added to VCE)

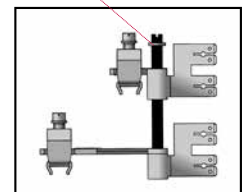

VCE

internal
+
front adjoining cross-connection

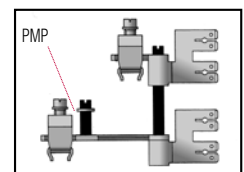

VCI + PM

internal parallel
+
rear adjoining cross connection

Two and three level circuits

- with 3 levels for sensors
- with LOCK system
- with possibility of LED indication
- hooked onto PR/3 type profiles according to IEC 60715 standard, TH/35 type
- available in beige and grey
- maximum continual operating temperature 100°C



TLS.2/T

TLS.2/U

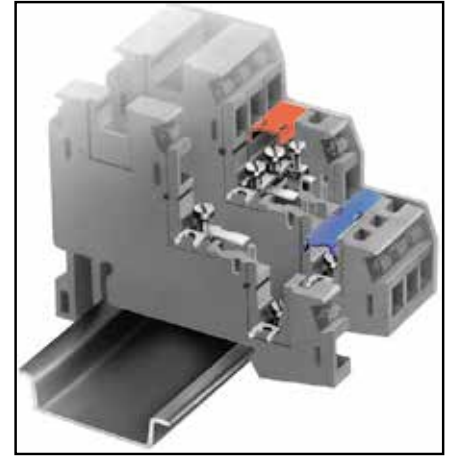

LOCK system

TLS.2/T Cat. No. TL120 (with green LED between upper and intermediate levels)

TLS.2/U Cat. No. TL110 (with green LED between upper and lower levels)

The /GR tag indicates the grey version.

grey version	
beige version	
(Ex)i version	
TECHNICAL CHARACTERISTICS	
function/type	
rated cross-section	(mm ²)
connecting capacity	
flexible	(mm ²)
rigid	(mm ²)
max. flexible with ferrule (mm ²) - ferrule type	
rated voltage / rated current / gauge	conf. to IEC 60947-7-1
rated voltage / rated current / AWG / tightening torque value	UL
(Ex e) rated voltage	(V)
rated impulse withstand voltage / pollution degree	
insulation stripping length	(mm)
tightening torque value (test / max)	(Nm)
height / width / thickness	TH/35 7.5 mm
height / width / thickness	TH/35 15 mm
height / width / thickness	G32

TLS.2/GR	
Cat. No.	TL100GR
TLS.2	
Cat. No.	TL100

three level - for sensors	2.5
0.2 - 4	0.2 - 4
0.2 - 4	0.2 - 4
2.5 - WP25/14	250 V / 24 A / A3
600 V / 15 A / 20-12 AWG / 3.5 lb.in	
-	-
4 KV / 3	8
0.4 / 0.8	52 / 62.5 / 6.2
-	60 / 62.5 / 6.2
-	-

For the installation on limited longitudinal space where high density wiring is needed together with reliable insulation, special feed-through two/three level terminal blocks are available. The three level terminal blocks are suitable for circuits which are to be used and connected with specific equipment, as for example proximity sensors. In fact, through the combined use of TLS.2 and TLD.2 terminal blocks it is possible to connect in an optimal and economic manner both power supply conductors on input to the sensor, and those on output carrying the signal of the same. Particularly in the **TLS.2 terminal block**, the intermediate and lower levels can be used to feed the sensors in d.c.; the feeding is distributed on the adjoining elements of the terminal board by means of a special **LOCK** connection system.

The above mentioned conducting bodies have a fork, pointed towards the exterior of the terminal block, which connects to the homologous element of the adjoining terminal block. The resulting contact is clamped with a screw, supplied already inserted in the conductor element.

The LOCK system, above described, allows the connection of positive and negative poles, without the use of any other parallel cross connection. At the upper, feed-through level, the conductor for the return signal of the sensor is connected; inserting **PRP/5** coloured protections in the special channels guarantees against all possible contact of the live parts and enables immediate identification of the polarity (Red for +, Blue for -).

TLD.2 terminal block is perfectly compatible with the **TLS.2** for the connection of proximity sensors, as it has the same electrical and mechanical characteristics. Two of six tightening units can be connected to the sensor feeding cables and distribute the power supply to the other sensors.

The cross-connection between the intermediate and lower levels of these terminal blocks to the contiguous ones of the TLS.2 can be performed by means of the two screws provided in the fork type conducting bodies of the TLS.2 – the first of the Series – free from whatever connection; between the TLD.2 and TLS.2 terminal blocks a TLD/PI intermediate end section must be interposed, to ensure electric insulation of the TLD.2 terminal block conducting parts, which otherwise would be uncovered.

TLD.2 terminal block can also be used for other connecting applications, in other types of circuits.

APPROVALS



ACCESSORIES	
End sections	grey beige blue
Permanent cross connection	
Rated current carrying capacity of jumper	(A)
Switchable cross connection	
Multiple common bar	250 mm
Shunting screw and sleeve	
Coloured partition	red, green, white
Cross connection barrier	red
Test plug socket	
Test plug	
Modular test plug	
End section for modular test plug	
Numbering strip	
Warning plate	on adjacent terminal blocks
Cover for cross-connection	
Marking tag	printed or blank
End bracket	

Type	Cat. No.
TLS/PT/GR	TL101GR
TLS/PT	TL101
PM/20/2 poles	PM202
PM/30/3 poles	PM303
PM/30/5 poles	PM305
PM/30/10 poles	PM310
24	
POS/41	POS41
PMP/02	PMP02
CPM/21	CPM21
DFU/3	DU03..
DFM/400	DF400
PSD/D	PD004
SDD/1	DD001
-	-
PRP/5	PRP05
CNU/8/51	NU0851
BTU for PR/DIN and PR/3	BT005
BTO for PR/3 only	BT007
BT/3 for PR/3 only	BT003

Two and three level circuits

- feed-through with 3 levels
- with 3 levels and earth connection
- mounting on TH 35-7.5 and TH 35-15 rails according to IEC 60715
- available in beige and grey
- maximum continual operating temperature 100°C



with earth connection on lower level



with earth connection on lower level and feed-through on intermediate and upper levels

The /GR tag indicates the grey version.

(*): 24 A factory wiring only

grey version	
beige version	
(Ex)i version	
TECHNICAL CHARACTERISTICS	
function/type	
rated cross-section	(mm ²)
connecting capacity	
flexible	(mm ²)
rigid	(mm ²)
max. flexible with ferrule (mm ²) - ferrule type	
rated voltage / rated current / gauge	conf. to IEC 60947-7-1
rated voltage / rated current / AWG / tightening torque value	UL
(Ex e) rated voltage	(V)
rated impulse withstand voltage / pollution degree	
insulation stripping length	(mm)
tightening torque value (test / max)	(Nm)
height / width / thickness	TH/35 7.5 mm
height / width / thickness	TH/35 15 mm
height / width / thickness	G32

TLE.2/GR	
Cat. No.	TL400GR
TLE.2	
Cat. No.	TL400
(Ex)i version	
TECHNICAL CHARACTERISTICS	
function/type	
rated cross-section	(mm ²)
connecting capacity	
flexible	(mm ²)
rigid	(mm ²)
max. flexible with ferrule (mm ²) - ferrule type	
rated voltage / rated current / gauge	conf. to IEC 60947-7-1
rated voltage / rated current / AWG / tightening torque value	UL
(Ex e) rated voltage	(V)
rated impulse withstand voltage / pollution degree	
insulation stripping length	(mm)
tightening torque value (test / max)	(Nm)
height / width / thickness	TH/35 7.5 mm
height / width / thickness	TH/35 15 mm
height / width / thickness	G32

TLD.2/GR	
Cat. No.	TL200GR
TLD.2	
Cat. No.	TL200
(Ex)i version	
TECHNICAL CHARACTERISTICS	
function/type	
rated cross-section	(mm ²)
connecting capacity	
flexible	(mm ²)
rigid	(mm ²)
max. flexible with ferrule (mm ²) - ferrule type	
rated voltage / rated current / gauge	conf. to IEC 60947-7-1
rated voltage / rated current / AWG / tightening torque value	UL
(Ex e) rated voltage	(V)
rated impulse withstand voltage / pollution degree	
insulation stripping length	(mm)
tightening torque value (test / max)	(Nm)
height / width / thickness	TH/35 7.5 mm
height / width / thickness	TH/35 15 mm
height / width / thickness	G32

TDE.2/GR	
Cat. No.	TL500GR
TDE.2	
Cat. No.	TL500
(Ex)i version	
TECHNICAL CHARACTERISTICS	
function/type	
rated cross-section	(mm ²)
connecting capacity	
flexible	(mm ²)
rigid	(mm ²)
max. flexible with ferrule (mm ²) - ferrule type	
rated voltage / rated current / gauge	conf. to IEC 60947-7-1
rated voltage / rated current / AWG / tightening torque value	UL
(Ex e) rated voltage	(V)
rated impulse withstand voltage / pollution degree	
insulation stripping length	(mm)
tightening torque value (test / max)	(Nm)
height / width / thickness	TH/35 7.5 mm
height / width / thickness	TH/35 15 mm
height / width / thickness	G32

APPROVALS



ACCESSORIES

End sections	grey beige intermediate
Permanent cross connection	
Rated current carrying capacity of jumper	(A)
Switchable cross connection	
Multiple common bar	250 mm
Shunting screw and sleeve	
Coloured partition	red, green, white
Cross connection barrier	red
Test plug socket	
Test plug	
Modular test plug	
End section for modular test plug	
Numbering strip	
Warning plate	on adjacent terminal blocks
Cover for cross-connection	
Marking tag	printed or blank
End bracket	
Mounting rail according to IEC 60715 Std.	

Type	Cat. No.
TLS/PT/GR	TL101GR
TLS/PT	TL101
PM/20/2 poles	PM202
PM/30/3 poles	PM303
PM/30/5 poles	PM305
PM/30/10 poles	PM310
24	
POS/41	POS41
PMP/02	PMP02
CPM/21	CPM21
DFU/3	DU03..
DFM/400	DF400
PSD/D	PD004
SDD/1	DD001
-	
-	
-	
-	
-	
PRP/5	PRP05
CNU/8/51	NU0851
BTU for PR/DIN and PR/3	BT005
BTO for PR/3 only	BT007
BT/3 for PR/3 only	BT003
-	
PR/3/AC of steel	PRO03
PR/3/AS same with slots	PRO05

Type	Cat. No.
TLD/PT/GR	TL201GR
TLD/PT	TL201
TLD/PI	TL202
PM/20/2 poles	PM202
PM/30/3 poles	PM303
PM/30/5 poles	PM305
PM/30/10 poles	PM310
24	
POS/41	POS41
PMP/02	PMP02
CPM/21	CPM21
DFU/3	DU03..
DFM/400	DF400
PSD/D	PD004
SDD/1	DD001
-	
-	
-	
-	
-	
PRP/5	PRP05
CNU/8/51	NU0851
BTU for PR/DIN and PR/3	BT005
BTO for PR/3 only	BT007
BT/3 for PR/3 only	BT003
-	
PR/3/AC of steel	PRO03
PR/3/AS same with slots	PRO05

Type	Cat. No.
TLD/PT/GR	TL201GR
TLD/PT	TL201
PM/20/2 poles	PM202
PM/30/3 poles	PM303
PM/30/5 poles	PM305
PM/30/10 poles	PM310
24	
POS/41	POS41
PMP/02	PMP02
CPM/21	CPM21
DFU/3	DU03..
DFM/400	DF400
PSD/D	PD004
SDD/1	DD001
-	
-	
-	
-	
-	
PRP/5	PRP05
CNU/8/51	NU0851
BTU for PR/DIN and PR/3	BT005
BTO for PR/3 only	BT007
BT/3 for PR/3 only	BT003
-	
PR/3/AC of steel	PRO03
PR/3/AS same with slots	PRO05

Fuse-holders

- for Ø 5 x 20 mm fuses, with possibility of warning of any broken fuse through LED microcircuit (CIL/...)
- basic versions available in beige and grey (where indicated)
- universal mounting for both PR/DIN and PR/3 rails which meet IEC 60715 norms, "G32" and TH/35 types
- maximum continual operating temperature 100°C



with possibility to perform cross connections both upstream and downstream the disconnection point

To determine the insulation voltage related to the different connection diagrams with PTC cross connections, consult the table on page 148

Max. dissipated power - In conf. with IEC 60947-7-3						
Terminal block	Voltage [V] (*)	Current [A]	Protection against overload and short circuit		Only protection against short circuit	
			Single configuration (PV) - [W]	Composite configuration (PV) - [W]	Single configuration (PVK) - [W]	Composite configuration (PVK) - [W]
SFR.4	250	6.3	2.5	1.6	2.5	2.5
SFR.6/M	250	6.3 / 10 Max.	2,5 (6.3 A)	1,6 (6.3 A)	4 (10 A)	2,5 (6.3 A)

(*) value referred to the insulation characteristics of the terminal block — (**) all terminal blocks are equipped with a hole suited for the sealing of the lever or for the insertion of a rod for the simultaneous opening of the lever of adjoining terminal blocks

The /GR tag indicates the grey version.

grey version
beige version
(Ex)i version

SFR.4/GR	Cat. No. SF900GR
SFR.4	Cat. No. SF900
SFR.4 (Ex)i	Cat. No. SF850

CBF.4/GR	Cat. No. CBF04GR
CBF.4 (Ex)i	Cat. No. CBF04I

SFR.6/M/GR	Cat. No. SR500GR
SFR.6/M	Cat. No. SR500
SFR.6/M (Ex)i	Cat. No. SR600

TECHNICAL CHARACTERISTICS

function/type	
rated cross-section	(mm²)
connecting capacity	
flexible	(mm²)
rigid	(mm²)
max. flexible with ferrule (mm²) - ferrule type	
rated voltage / rated current / gauge	conf. to IEC 60947-7-1
rated voltage / rated current / AWG / tightening torque value	UL
(Ex e) rated voltage	(V)
rated impulse withstand voltage / pollution degree	
insulation stripping length	(mm)
tightening torque value (test / max)	(Nm)
height / width / thickness	TH/35 7.5 mm
height / width / thickness	TH/35 15 mm
height / width / thickness	G32

	for ø 5x20 mm fuse
4	4
0.2 - 6	0.2 - 6
0.2 - 6	0.2 - 6
4 - WP40/16	4 - WP40/16
800 V (*) / 6.3 A max (20 A with CO/5) / A4	630 V / 6.3 A max / A4
600 V / 6.3 A / 20-12 AWG / 4.4 lb.in.	600 V / 6.3 A / 20-12 AWG / 4.4 lb.in.
-	-
6 KV / 3	6 KV / 3
11	10
0.5 / 1.2	0.5 / 1
52 / 52 / 8	76 / 57 / 6
60 / 52 / 8	83 / 57 / 6
56 / 52 / 8	-

	for ø 5x20 mm fuse
4	4
0.2 - 6	0.2 - 6
0.2 - 6	0.2 - 6
4 - WP40/16	4 - WP40/16
630 V / 6.3 A max / A4	630 V / 6.3 A max / A4
600 V / 6.3 A / 20-12 AWG / 4.4 lb.in.	600 V / 6.3 A / 20-12 AWG / 4.4 lb.in.
-	-
6 KV / 3	6 KV / 3
10	10
0.5 / 1	0.5 / 1
76 / 57 / 6	76 / 57 / 6
83 / 57 / 6	83 / 57 / 6
-	-

	for ø 5x20 mm fuse
6	6
0.2 - 10	0.2 - 10
0.2 - 10	0.2 - 10
6 - WP60/20	6 - WP60/20
630 V (*) / 10 A max. (19 A with CO/5) / A5	630 V (*) / 10 A max. (19 A with CO/5) / A5
600 V / 6.3 A / 20-8 AWG / 13 lb.in.	600 V / 6.3 A / 20-8 AWG / 13 lb.in.
-	-
6 KV / 3	6 KV / 3
11	11
0.8 / 1.4	0.8 / 1.4
59 / 79 / 10	59 / 79 / 10
67 / 79 / 10	67 / 79 / 10
63 / 79 / 10	63 / 79 / 10

APPROVALS



ACCESSORIES

End sections	grey beige blue
"Easy Bridge" (PTC) cross connection (intrinsically IPXXB protected once mounted)	
Available also in coloured version (PTP)	
Ref. p. 130	
Rated current carrying capacity of jumper	(A)
Cross-connection identification strip(100 mm)	green
Multiple common bar	250 mm
Shunting screw and sleeve	
Coloured partition	red, green, white
Cross connection barrier	red
Test plug socket	
Test plug	
Numbering strip	
Miniature fuse	Ø 5 x 20 mm
LED circuit	non-polarized
- 2 contact slats	
- 1 microcircuit or lamp	
- 1 transparent cover - to be inserted in such a sequence	
Marking tag	printed or blank
End bracket	

Type	Cat. No.
SFR.4/PT/GR	SF701GR
SFR.4/PT	SF701
SFR.4/PT (Ex)i	SF801
-	
-	
-	
-	
-	
DFU/3	DU03..
-	
-	
-	
-	
F5	FN...
CIL/12	SF512
CIL/24	SF524
CIL/48	SF548
CIL/115	SF515
CIL/230	SF523
CNU/8/51	NU0851
BTU for PR/DIN and PR/3	BT005
BT/DIN/PO only for PR/DIN only	BT001
BT/3-BTO for PR/3 only	BT003-BT007

Type	Cat. No.
CB/PT/GR	CB401GR
-	
CB/PT (Ex)i	CB402
PTC/4/02 poles	PTC0402
PTC/4/03 poles	PTC0403
PTC/4/05 poles	PTC0405
PTC/4/10 poles	PTC0410
PTC/4/00 (42 poles)	PTC0400
32	
PTC/SP	PTC0990
-	
-	
-	
-	
-	
F5	FN...
CIL/12-24-48	CB518
CIL/115-230	CB523
CNU/8/51	NU0851
BTU for PR/DIN and PR/3	BT005
BT/DIN/PO only for PR/DIN	BT001
BT/3-BTO only for PR/3	BT003-BT007

Type	Cat. No.
SFR.6/PT/GR	SR301GR
SFR.6/PT	SR301
SFR.6/PT (Ex)i	SR401
PTC/20/02 poles	PTC2002
PTC/20/03 poles	PTC2003
PTC/20/05 poles	PTC2005
PTC/20/10 poles	PTC2010
PTC/20/00 (25 poles)	PTC2000
25	
PTC/SP	PTC0990
-	
-	
-	
DFU/7	DU07..
DFM/300	DF300
-	
SDD/1	DD001
-	
F5	FN...
KITLSN/12-24	KIT1224
KITLSN/70-380	KIT70380
CNU/8/51	NU0851
BTU for PR/DIN and PR/3	BT005
BT/DIN/PO for PR/DIN only	BT001
BT/3-BTO for PR/3 only	BT003-BT007

Fuse-holders

- for Ø 5 x 20 mm fuses, with possibility of warning of any broken fuse through LED microcircuit (CIL/...)
- basic versions available in beige and grey (where indicated)
- for Ø 6.3 x 32 mm fuses
- with solder lug
- universal mounting for both PR/DIN and PR/3 rails which meet IEC 60715 norms, "G32" and TH/35 types
- maximum continual operating temperature 100°C

Please, see page 148 (table) to determine the insulation voltage of the different PTC connection diagrams

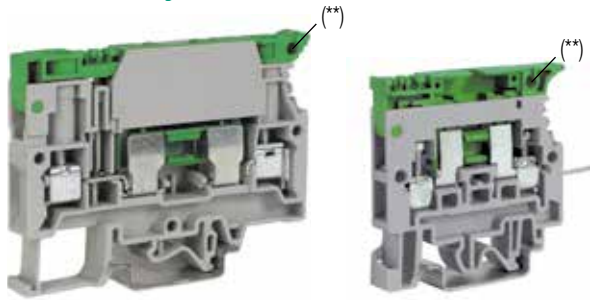

The terminal block is equipped with a lever suited to house a Ø 6.3 x 32 mm - 500 V fuse (not supplied)

4 x 0.8 mm solder lug

Max. dissipated power - In conf. with IEC 60947-7-3						
Terminal block	Voltage [V] (*)	Current [A]	Protection against overload and short circuit		Only protection against short circuit	
			Single configuration (PV) - [W]	Composite configuration (PV) - [W]	Single configuration (PVK) - [W]	Composite configuration (PVK) - [W]
SFR.6	250	10	2,5 (2,5 A)	1,6 (1 A)	4 (10 A)	2,5 (2,5 A)
SFR.4	250	6.3	2,5	1,6	2,5	2,5

(*) value referred to the insulation characteristics of the terminal block — (**) all terminal blocks are equipped with a hole suited for the sealing of the lever or for the insertion of a rod for the simultaneous opening of the lever of adjoining terminal blocks — (****) neon bulb

The /GR tag indicates the grey version.

grey version
beige version
(Ex)i version

SFR.6/GR	Cat. No. SR300GR
SFR.6	Cat. No. SR300
SFR.6 (Ex)i	Cat. No. SR400

SFR.4/VS/GR	Cat. No. SF910GR
SFR.4/VS	Cat. No. SF910

TECHNICAL CHARACTERISTICS

function/type	
rated cross-section	(mm ²)
connecting capacity	
flexible	(mm ²)
rigid	(mm ²)
max. flexible with ferrule (mm ²) - ferrule type	
rated voltage / rated current / gauge	conf. to IEC 60947-7-1
rated voltage / rated current / AWG / tightening torque value	UL
(Ex e) rated voltage	(V)
rated impulse withstand voltage / pollution degree	
insulation stripping length	(mm)
tightening torque value (test / max)	(Nm)
height / width / thickness	TH/35 7.5 mm
height / width / thickness	TH/35 15 mm
height / width / thickness	G32

• for Ø 6 x 32 mm fuse
6
0.2 - 10
0.2 - 10
6 - WP60/20
630 V (*) / 10 A (33 A with cylinder) / A5
600 V / 10 A / 20-8 AWG / 13 lb.in
-
6 KV (*) / 3
11
0.8 / 1.4
59 / 79 / 10
67 / 79 / 10
63 / 79 / 10

FOR 5 x 20 FUSE WITH SOLDER LUG

for fuse with solder lug
4
0.2 - 6
0.2 - 6
4 - WP40/16
400 V (*) / 6.3 A max (15 A with CO/5) / A4
-
4 KV (*) / 3
11
0.5 / 1.2
52 / 65 / 8
60 / 65 / 8
56 / 65 / 8

APPROVALS



ACCESSORIES

End sections	grey beige blue
Permanent cross connection (pre-assembled)	
(***) intrinsically IPXXB protected once mounted	
Rated current carrying capacity of jumper	(A)
Cross-connection identification strip(100 mm)	green
Multiple common bar	250 mm
Shunting screw and sleeve	
Coloured partition	red, green, white
Cross connection barrier	red
Test plug socket	
Test plug	
Numbering strip	
Miniature fuse	Ø 5 x 20 mm
LED circuit	non-polarized
- 2 contact slats	
- 1 microcircuit or lamp	
- 1 transparent cover - to be inserted in such a sequence	
Marking tag	printed or blank
End bracket	

Type	Cat. No.
SFR.6/PT/GR	SR301GR
SFR.6/PT	SR301
SFR.6/PT (Ex)i	SR401
PTC/20/02 poles (***)	PTC2002
PTC/20/03 poles (***)	PTC2003
PTC/20/05 poles (***)	PTC2005
PTC/20/10 poles (***)	PTC2010
PTC/20/00 (25 poles) (***)	PTC2000
25	
PTC/SP	PTC0990
-	
DFU/7	DU07..
DFM/300	DF300
-	
SDD/1	DD001
-	
-	
KITLSN/12-24	KIT1224
KITLSN/70-380	KIT70380
CNU/8/51	NU0851
BTU for PR/DIN and PR/3	BT005
BT/DIN/PO for PR/DIN only	BT001
BT/3-BTO for PR/3 only	BT003-BT007

Type	Cat. No.
SFR.4/PT/GR	SF701GR
SFR.4/PT	SF701
-	
-	
DFU/3	DU03..
-	
-	
F5	FN...
CIL/12-24-48	SF518
CIL/115-230	SF510
CNU/8/51	NU0851
BTU for PR/DIN and PR/3	BT005
BT/DIN/PO for PR/DIN only	BT001
BT/3-BTO for PR/3 only	BT003-BT007

Fuse-holder/diode-holder

- mounted onto PR/3 profiles conforming to IEC 60715 standards, TH/35 type
- two and three level circuits - upper level fuse holder/diode holder, lower feed-through
- for $\varnothing 5 \times 20$ mm fuses (supplied separately), with possible warning of any broken fuse through LED microcircuit (CIL/...)
- for 1 A diodes (types 1N4001 – 1N4007)
- for 3 A diodes (type BY255)
- available in grey and beige
- maximum continual operating temperature 100°C



The **/GR** tag indicates the grey version.

grey version

beige version

TECHNICAL CHARACTERISTICS

function/type	
rated cross-section	(mm ²)
connecting capacity	
flexible	(mm ²)
rigid	(mm ²)
max. flexible with ferrule (mm ²) - ferrule type	
rated voltage / rated current / gauge	conf. to IEC 60947-7-1/3
rated voltage / rated current / AWG / tightening torque value	UL
(Ex e) rated voltage	□ / □ (V)
rated impulse withstand voltage / pollution degree	
insulation stripping length	(mm)
tightening torque value (test / max)	(Nm)
height / width / thickness	□ TH/35 7.5 mm
height / width / thickness	□ TH/35 15 mm
height / width / thickness	□ G32

DSF.4/GR Cat. No. **DA200GR**

DSF.4 Cat. No. **DA200**

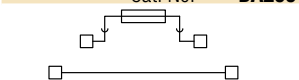

On two levels: $\varnothing 5 \times 20$ mm fuse-holder (upper level) - feed-through (lower level)
4

0.2 – 6
0.2 – 6
4 - WP40/16
800 V / [6.3 A (10 A with CO/5) (upper level)] - 32 A (lower level) / A4
-
8 kV / 3
9
0.5 / 1.2
69 / 79.5 / 8
77 / 79.5 / 8
- / - / -

APPROVALS



ACCESSORIES

End sections	grey beige blue
Coloured partition	red, green, white
Cross connection barrier	red
Test plug socket	
Numbering strip	
Miniature fuse	$\varnothing 5 \times 20$ mm
Conductor element	$\varnothing 5 \times 20$ mm
LED circuit	non-polarized
- 2 contact slats	
- 1 microcircuit or lamp	
- 1 transparent cover - to be inserted in such a sequence	
Marking tag	printed or blank
Terminal block with LED 12 ÷ 48 V non polarised micro-circuit	
Terminal block with LED 115 ÷ 230 V non polarised micro-circuit	
1 A cartridge / insert	
3 A cartridge / insert	
terminal block with 1 A diode	
terminal block with 3 A diode	
End bracket	

Type	Cat. No.
DSF.4/PT/GR	DS401GR
DSF.4/PT	DS401
DFU/7	DU07..
-	
-	
-	
F5/...	FN...
CO/5	VL103
CIL/12-24-48	SF518
CIL/115-230	SF510
CNU/8	NU08...
CNU/10	NU10...
DSF.4/GR/C12-48	DA518GR
DSF.4/GR/C115-230	DA510GR
SFR/11A (with 1 A diode)	SF992
SFR/13A (with 3 A diode)	SF993
DSF.4/GR/D1A	DA901GR
DSF.4/GR/D3A	DA903GR
BTU for PR/DIN and PR/3	BT005
BT/3-BTO for PR/3 only	BT003-BT007

Fuse-holders

- for “blade” fuse in compliance with DIN 72581/3F – ISO 8820
- basic versions available in beige and grey (where indicated)
- possible insertion of the “Easy Bridge” system multi-polar connection upstream of the fuse
- universal mounting for both PR/DIN and PR/3 rails which meet IEC 60715 norms, “G32” and TH/35 types
- maximum continual operating temperature 100°C

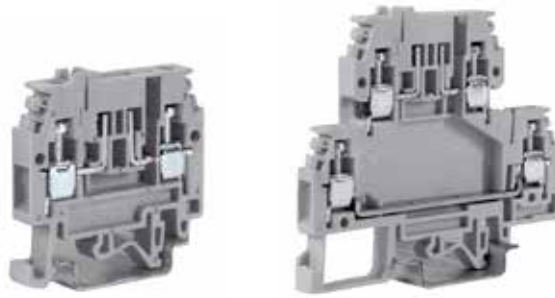

(*) value referred to the insulation characteristics of the terminal block
 (**) values referred, respectively, to lower and upper levels
 (***) suitable for all the blade fuses with similar dimensions
 (****) separate configuration conf. to IEC 60947-7-3

For the isolation figures with cross connections refer to the table on page 131

The /GR tag indicates the grey version.

grey version	
beige version	
(Ex)i version	
TECHNICAL CHARACTERISTICS	
function/type	
rated cross-section	(mm ²)
connecting capacity	
flexible	(mm ²)
rigid	(mm ²)
max. flexible with ferrule (mm) - ferrule type	
rated voltage / rated current / gauge	conf. to IEC 60947-7-1
rated voltage / rated current / AWG / tightening torque value	UL
(Ex e) rated voltage	(V)
rated impulse withstand voltage / pollution degree	
insulation stripping length	(mm)
tightening torque value (test / max)	(Nm)
height / width / thickness	TH/35 7.5 mm
height / width / thickness	TH/35 15 mm
height / width / thickness	G32

APPROVALS

ACCESSORIES	
End sections	grey beige blue
“Easy Bridge” (PTC) cross connection (intrinsically IPXXB protected once mounted) Available also in coloured version (PTP) Ref. p. 130	
Rated current carrying capacity of jumper	(A)
Cross-connection identification strip(100 mm)	green
Switchable cross connection	
Multiple common bar	250 mm
Shunting screw and sleeve	
Coloured partition	red, green, white
Cross connection barrier	red
Test plug socket	
Test plug	
Modular test plug	
End section for modular test plug	
Blade-type fuses	In = 2 A
according to DIN 72581/3F ISO 8820	In = 5 A
- max voltage 32 V	In = 7.5 A In = 15 A
Marking tag	printed or blank
End bracket	

MPFA.4/GR	
Cat. No.	MF100GR
MPFA.4	
Cat. No.	MF100
for blade fuse (***)	4
0.2 – 6	
0.2 – 6	
4 - WP40/16	
400 V (*) / 15 A (****) / A4	
600 V / 6.3 A / 26-10 AWG / 4.4 lb.in	
-	
6 KV (*) / 3	
9	
0.5 / 1.2	
47 / 47 / 6	
55 / 47 / 6	
51 / 47 / 6	



Approvals referred to use with CPF/5 fuse carrier cartridge

DSFA.4/GR	
Cat. No.	DA100GR
DSFA.4	
Cat. No.	DA100
2 level - for blade fuse (***) on the upper level	4
0.2 – 6	
0.2 – 6	
4 - WP40/16	
400 V (*) / 15 A (****) - 32 A (**) / A4	
300 V / 6.3 - 30 A / 26-10 AWG / 4.4 lb.in	
-	
6 KV / 3	
9	
0.5 / 1.2	
68 / 78 / 6	
75 / 78 / 6	
72 / 78 / 6	



Approvals referred to use with CPF/5 fuse carrier cartridge



MPFA.4 – detail of the terminal blocks with numbering CNU/8 and CNU/8/51, “blade” fuse seen from the PTC/4 cross connection and seen from the PTC cross connection. The terminal block can be supplied already including a non-polarised LED warning circuit, to warn if the fuse breaks. Two versions are available, depending on the different power supply voltages.

MPFA.4/L12 code MF112 (complete with non-polarised 12 V LED circuit)
MPFA.4/L24 code MF124 (complete with non-polarised 24 V LED circuit)

Type		Cat. No.	
MPS.4/PT/GR		MP901GR	
MPS.4/PT		MP901	
-			
PTC/4/02 poles		PTC0402	
PTC/4/03 poles		PTC0403	
PTC/4/05 poles		PTC0405	
PTC04/10 poles		PTC0410	
PTC/4/00 (42 poles)		PTC0400	
32			
-			
-			
-			
DFU/3		DU03..	
DFM/500		DF500	
-			
-			
-			
F32/2 In = 2 A		FN03202	
F32/5 In = 5 A		FN03205	
F32/7 In = 7.5 A		FN03207	
F32/15 In = 15 A		FN03215	
CNU/8/51		NU0851	
BTU for PR/DIN and PR/3		BT005	
BT/DIN/PO for PR/DIN only		BT001	
BT/3-BTO for PR/3 only		BT003-BT007	

Type		Cat. No.	
DSS/PT/GR		DS301GR	
DSS/PT		DS301	
-			
PTC/4/02 poles		PTC0402	
PTC/4/03 poles		PTC0403	
PTC/4/05 poles		PTC0405	
PTC04/10 poles		PTC0410	
PTC/4/00 (42 poles)		PTC0400	
32			
-			
-			
-			
DFU/7		DU07..	
DFM/500		DF500	
-			
-			
-			
F32/2 In = 2 A		FN03202	
F32/5 In = 5 A		FN03205	
F32/7 In = 7.5 A		FN03207	
F32/15 In = 15 A		FN03215	
CNU/8/51		NU0851	
BTU for PR/DIN and PR/3		BT005	
BT/DIN/PO for PR/DIN only		BT001	
BT/3-BTO for PR/3 only		BT003-BT007	



DSFA.4 – detail of the terminal blocks with numbering CNU/8 and CNU/8/51, blade fuse and view of the PTC/4 cross connections on the upper level (upstream from the fuse) and on the lower level. The terminal block can be supplied already including a non-polarised LED warning circuit, to warn if the fuse breaks. Two versions are available, depending on the different power supply voltages.

DSFA.4/L12 code DA112 (complete with non-polarised 12 V LED circuit)
DSFA.4/L24 code DA124 (complete with non-polarised 24 V LED circuit)

Component-holder cartridge



- to be mounted on the terminal blocks: MPFA.4, DSFA.4 and HMFA.2 (see p. 84)
- possible insertion of Ø 5 x 20 mm fuse (our type F5, with or without warning LED, diode (1 or 3 A), Ø 5 x 20 mm brass cylinder and other components (e.g. resistances)
- maximum continual operating temperature 100°C

Max. dissipated power - In conf. with IEC 60947-7-3						
Terminal block	Voltage [V] (*)	Current [A]	Protection against overload and short circuit		Only protection against short circuit	
			Single configuration (PV) - [W]	Composite configuration (PV) - [W]	Single configuration (PVK) - [W]	Composite configuration (PVK) - [W]
MPFA.4 + CPF/5	250	6.3	1.6	1.6	4	1.6
DSFA.4 + CPF/5	250	6.3	1.6	1.6	4	1.6
HMFA.2 + CPF/5	250	6.3	1.6	1.6	4	1.6

standard version

TECHNICAL CHARACTERISTICS

function/type	
rated cross-section	(mm ²)
connecting capacity	
flexible	(mm ²)
rigid	(mm ²)
max. flexible with ferrule (mm ²) - ferrule type	
rated voltage / rated current / gauge	conf. to IEC 60947-7-1
rated voltage / rated current / AWG / tightening torque value	UL
(Ex e) rated voltage	(V)
rated impulse withstand voltage / pollution degree	
insulation stripping length	(mm)
tightening torque value (test / max)	(Nm)
height / width / thickness	TH/35 7.5 mm
height / width / thickness	TH/35 15 mm
height / width / thickness	G32

APPROVALS

ACCESSORIES

Marking tag	printed or blank
Tinned brass conductor	Ø 5 x 20 mm
Cartridge / insert with 1 A diode	
Cartridge / insert with 3 A diode	

VERSIONS PROVIDED

With non-polarized LED microcircuit	12 Vdc / Vac
With non-polarized LED microcircuit	24 Vdc / Vac
With non-polarized LED microcircuit	48 Vdc / Vac
With non-polarized LED microcircuit	115 Vdc / Vac
With non-polarized LED microcircuit	230 Vdc / Vac
With 1 A diode (1N4001 ÷ 1N4007 types)	
With 3 A diode (BY255 type)	
With resistor 1200 Ω (1 W ± 5%)	

Note:

(a) with fuse Ø 5 x 20 mm, 250 V, I_{max} = 6.3 A – with brass pin I_{max} = 10 A

(b) when the cartridge is mounted on the terminal blocks, total, also taking into account the supporting rail:

Terminal block	Height on rail TH/35 7.5 (mm)	Height on rail TH/35 15 (mm)	Height on rail G32 (mm)
HMFA.2	57	75	-
MPFA.4	75	83	79
DSFA.4	96	104	100

CPF/5

Cat. No.	CPF05
component holder cartridge	-
	-
	-
	-
320 V (a) / 6.3 A (a) / A5	-
	-
4 kV / 3	-
	-
(b) / 33 / 6	-
(b) / 33 / 6	-
(b) / 33 / 6	-



Approvals referred to the terminal blocks on which the cartridge is mounted – see table

Type	Cat. No.
CNU/8/51	NU0851
CO/5	VL103
SFR/11A (with 1 A diode)	SF992
SFR/13A (with 3 A diode)	SF993

Type	Cat. No.
CPF/5L12	CPF512
CPF/5L24	CPF524
CPF/5L48	CPF548
CPF/5L115	CPF511
CPF/5L230	CPF523
CPF/5D1A	CPF501
CPF/5D3A	CPF503
CPF/5R	CPR05

The cartridge can contain a spare fuse, instead of the LED signalling circuit.

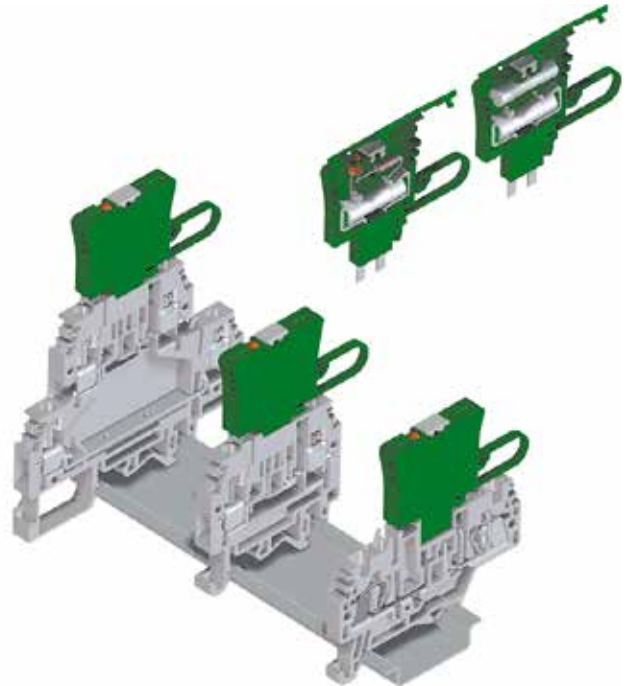

View of the different choices for mounting the cartridge respectively on terminals DSFA.4, MPFA.4 or HMFA.2.

When mounted on HMFA.2 terminal blocks, placed alongside each other, a terminal plate needs to be provided for between one terminal block and another owing to the pitch differential between terminal block and cartridge.

Fuse-holders

- for Ø 6.3 x 32 mm fuses
- for Ø 6.3 x 32 mm fuses, with possibility of warning of any broken fuse through LED microcircuit (CIL/...)
- universal mounting for both PR/3 rails which meet IEC norms, "G32" and TH/35 types
- available in beige
- maximum continual operating temperature 100°C



The terminal block is fitted with a lever provided for inserting a Ø 6.3 x 32 mm - 500 V fuse (not supplied by us).



The terminal block is fitted with a lever which enables insertion of a Ø 6.3 x 32 mm - 500 V fuse and a non-polarised LED microcircuit. The LED comes on to warn that the fuse is broken. The terminal block can be supplied already with the CIL circuit mounted for inserting a non-polarised LED circuit.



The terminal block is fitted with a lever which enables insertion of a Ø 6.3 x 32 mm - 500 V fuse and a neon light with resistance incorporated (our type LSN Ø 6 x 26 mm - 380 V max). Breaking of the fuse causes the light to come on.

(*) value referred to the insulation characteristics of the terminal block
 (**) for simultaneous disconnection of adjoining terminal blocks



standard version

TECHNICAL CHARACTERISTICS

function/type	
rated cross-section	(mm ²)
connecting capacity	
flexible	(mm ²)
rigid	(mm ²)
max. flexible with ferrule (mm ²) - ferrule type	
rated voltage / rated current / gauge	conf. to IEC 60947-7-1
rated voltage / rated current / AWG / tightening torque value	UL (Ex e) rated voltage / (V)
rated impulse withstand voltage / pollution degree	
insulation stripping length	(mm)
tightening torque value (test / max)	(Nm)
height / width / thickness	TH/35 7.5 mm
height / width / thickness	TH/35 15 mm
height / width / thickness	G32

APPROVALS

ACCESSORIES

End sections	beige blue
Permanent cross connection (pre-assembled) (***) intrinsically IPXXB protected once mounted	
Switchable cross connection	
Multiple common bar	250 mm
Shunting screw and sleeve	
Coloured partition	red, green, white
Cross connection barrier	red
Test plug socket	
Test plug	
MSM handle (**)	
Neon lamp Ø 6 x 26 mm	
LED circuit made up of:	non-polarized
- 2 contacts	
- 1 microcircuit	
- 1 transparent cover - to be inserted in such a sequence	
Marking tag	printed or blank
End bracket	

FPC.10

Cat. No. **FP100**

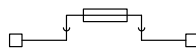

for Ø 6.3 x 32 mm fuses	10
flexible	1.5 - 16
rigid	1.5 - 16
max. flexible with ferrule (mm ²) - ferrule type	10 - WP100/21
rated voltage / rated current / gauge	800 V (*) / 10 A (20 A with SFC/CO) / B6
rated voltage / rated current / AWG / tightening torque value	600 V / 15 A / 20-6 AWG / 7 lb.in.
rated impulse withstand voltage / pollution degree	6 kV (*) / 3
insulation stripping length	17
tightening torque value (test / max)	1.2 / 1.9
height / width / thickness	70 / 63 / 12
height / width / thickness	78 / 63 / 12
height / width / thickness	74 / 63 / 12



Type

Type	Cat. No.
-	-
-	-
-	-
DFU/6	DU06..
-	-
SDD/2	DD002
MSM (6 elements)	FC103
-	-
CNU/8/51	NU0851
BTU for PR/DIN and PR/3	BT005
BT/DIN/PO for PR/DIN only	BT001
BT/3-BTO for PR/3 only	BT003-BT007

FPL.10/C

Cat. No. **FP300**

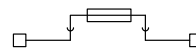

for Ø 6.3 x 32 mm fuses with LED	10
flexible	1.5 - 16
rigid	1.5 - 16
max. flexible with ferrule (mm ²) - ferrule type	10 - WP100/21
rated voltage / rated current / gauge	800 V (*) / 10 A / B6
rated voltage / rated current / AWG / tightening torque value	300 V / 15 A / 20-6 AWG / 7 lb.in.
rated impulse withstand voltage / pollution degree	6 kV (*) / 3
insulation stripping length	17
tightening torque value (test / max)	1.2 / 1.9
height / width / thickness	71 / 63 / 12
height / width / thickness	79 / 63 / 12
height / width / thickness	75 / 63 / 12



Type

Type	Cat. No.
-	-
-	-
-	-
DFU/6	DU06..
-	-
SDD/2	DD002
MSM (6 elements)	FC103
-	-
CIL/12-24-48	CB518
CIL/115-230	CB523
CNU/8/51	NU0851
BTU for PR/DIN and PR/3	BT005
BT/DIN/PO for PR/DIN only	BT001
BT/3-BTO for PR/3 only	BT003-BT007

FPL.10/L

Cat. No. **FP200**

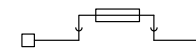

for Ø 6.3 x 32 mm fuses with lamp	10
flexible	1.5 - 16
rigid	1.5 - 16
max. flexible with ferrule (mm ²) - ferrule type	10 - WP100/21
rated voltage / rated current / gauge	800 V (*) / 10 A (20 A with SFC/CO) / B6
rated voltage / rated current / AWG / tightening torque value	300 V / 15 A / 20-6 AWG / 7 lb.in.
rated impulse withstand voltage / pollution degree	6 kV (*) / 3
insulation stripping length	17
tightening torque value (test / max)	1.2 / 1.9
height / width / thickness	71 / 63 / 12
height / width / thickness	79 / 63 / 12
height / width / thickness	75 / 63 / 12



Type

Type	Cat. No.
-	-
-	-
-	-
DFU/6	DU06..
-	-
SDD/2	DD002
MSM (6 elements)	FC103
LSN	FL202
-	-
CNU/8/51	NU0851
BTU for PR/DIN and PR/3	BT005
BT/DIN/PO for PR/DIN only	BT001
BT/3-BTO for PR/3 only	BT003-BT007

Fuse-holders with warning LED circuit

- for Ø 5x20 mm fuses, with LED warning circuit capable of detecting intervention of the fuse
- with LED (CIL) microcircuits - non-polarised for operation under alternating and/or direct current
- available in beige and grey
- maximum continual operating temperature 100°C



CIL... circuit



CIL... circuit

beige version	
grey version	
TECHNICAL CHARACTERISTICS	
function/type	
rated cross-section	(mm ²)
connecting capacity	
flexible	(mm ²)
rigid	(mm ²)
max. flexible with ferrule (mm ²) - ferrule type	
rated voltage / rated current / gauge	conf. to IEC 60947-7-1
rated voltage / rated current / AWG / tightening torque value	UL
(Ex e) rated voltage	(V)
rated impulse withstand voltage / pollution degree	
insulation stripping length	(mm)
tightening torque value (test / max)	(Nm)
height / width / thickness	TH/35 7.5 mm
height / width / thickness	TH/35 15 mm
height / width / thickness	G32

SFR.4/C48	Cat. No. SF948
with 48 V non-polarized LED circuit	
SFR.4/C230	Cat. No. SF923
with 230 V non-polarized LED circuit	
SFR.4/C48/GR	Cat. No. SF948GR
with 48 V non-polarized LED circuit	
SFR.4/C230/GR	Cat. No. SF923GR
with 230 V non-polarized LED circuit	

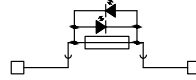

For Ø 5 x 20 mm fuse and LED circuit
4

0.2 – 6
0.2 – 6
4 - WP40/16
800 V (*) / 6.3 A max / A4
600 V / 6.3 A / 20-12 AWG / 4.4 lb.in.
-
6 kV (*) / 3
11
0.5 / 1.2
52 / 52 / 8
60 / 52 / 8
56 / 52 / 8

CBF.4/C48/GR	Cat. No. CBF448GR
with 48 V non-polarized LED circuit	
CBF.4/C23/GR	Cat. No. CBF423GR
with 230 V non-polarized LED circuit	

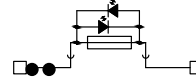

For Ø 5 x 20 mm fuse and LED circuit
4

0.2 – 6
0.2 – 6
4 - WP40/16
630 V (*) / 6.3 A max (20A with CO/5) / A4
600 V / 6.3 A / 20-12 AWG / 4.4 lb.in.
-
6 kV (*) / 3
11
0.5 / 1
76 / 57 / 6
83 / 57 / 6
-

FPL.10/C48	Cat. No. FP948
with 48 V non-polarized LED circuit	
FPL.10/C230	Cat. No. SF923
with 230 V non-polarized LED circuit	

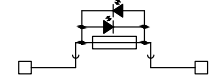

For Ø 6.3 x 32 mm fuse and LED circuit
10

1.5 – 16
1.5 – 16
10 - WP100/21
800 V (*) / 10 A / B6
300 V / 15 A / 20-6 AWG / 7 lb.in.
-
6 kV (*) / 3
17
1.2 / 1.9
71 / 63 / 12
79 / 63 / 12
75 / 63 / 12

APPROVALS



ACCESSORIES	
End sections	grey beige
"Easy Bridge" permanent cross connection 2 poles (intrinsically IPXXB protected once mounted)	3 poles
Available also in coloured version Ref. Page 130	5 poles 10 poles 42 poles
Rated current carrying capacity of jumper	(A)
Cross-connection identification strip(100mm)	green
Coloured partition	red
Miniature fuse	Ø 5 x 20 mm
Conducting element	
Marking tag	printed or blank
End bracket	

Type	Cat. No.
SFR/PT/GR	SF701GR
SFR/PT	SF701
-	-
-	-
-	-
-	-
-	-
-	-
-	-
DFU/3	DU03R
F5	FN...
CO/5	VL103
CNU/8/51	NU0851
BTU for PR/DIN and PR/3	BT005
BT/DIN/PO for PR/DIN only	BT001
BT/3-BTO for PR/3 only	BT003-BT007

Type	Cat. No.
CB/PT/GR	CB401GR
-	-
PTC/4/02	PTC0402
PTC/4/03	PTC0403
PTC/4/05	PTC0405
PTC/4/10	PTC0410
PTC/4/00	PTC0400
32	
PTC/SP	PTC0990
-	-
F5	FN...
CO/5	VL103
CNU/8/51	NU0851
BTU for PR/DIN and PR/3	BT005
BT/3-BTO for PR/3 only	BT003-BT007

Type	Cat. No.
-	-
-	-
-	-
-	-
-	-
-	-
-	-
DFU/6	DU06R
MSM	FC103
-	-
-	-
BTU for PR/DIN and PR/3	BT005
BT/DIN/PO for PR/DIN only	BT001
BT/3-BTO for PR/3 only	BT003-BT007

Disconnects

- disconnects with lever
- possible to create parallel connections
- "Easy Bridge" system: multi-polar cross connection without the need for additional protections
- available in the colours: grey, beige, or in a version appropriate for use with "intrinsically safe" (Ex)i circuits (blue)
- maximum continual operating temperature 100°C



grey version

beige version

(Ex)i version

TECHNICAL CHARACTERISTICS

function/type	
rated cross-section	(mm ²)
connecting capacity	
flexible	(mm ²)
rigid	(mm ²)
max. flexible with ferrule (mm) - ferrule type	
rated voltage / rated current / gauge	conf. to IEC 60947-7-1
rated voltage / rated current / AWG / tightening torque value	UL
(Ex e) rated voltage	(V)
rated impulse withstand voltage / pollution degree	
insulation stripping length	(mm)
tightening torque value (test / max)	(Nm)
height / width / thickness	TH/35 7.5 mm
height / width / thickness	TH/35 15 mm

CBS.2/GR

Cat. No. **CBS02GR**

CBS.2

Cat. No. **CBS02**

CBS.2 (Ex)i

Cat. No. **CBS02I**

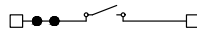

disconnect lever	2
0.2 - 4	
0.2 - 4	
2 - WP25/14	
630V / 22A / A3	
600 V / 20 A / 20-12 AWG / 3.5 lb.in.	
-	
6 KV (*) / 3	
9	
0.4 / 0.6	
52 / 57 / 5	
60 / 57 / 5	

CBS.4/GR

Cat. No. **CBS04GR**

CBS.4

Cat. No. **CBS04**

CBS.4 (Ex)i

Cat. No. **CBS04I**

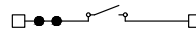

disconnect lever	4
0.2 - 6	
0.2 - 6	
4 - WP40/16	
630V / 24A / A4	
600 V / 24 A / 20-10 AWG / 4.4 lb.in.	
-	
6 KV / 3	
10	
0.5 / 0.8	
52 / 57 / 6	
60 / 57 / 6	

APPROVALS



ACCESSORIES

End sections	grey
	beige
	blue
"Easy Bridge" (PTC) cross connection (intrinsically IPXXB protected once mounted)	2 poles
Available also in coloured version (PTP)	3 poles
Ref. p. 131	5 poles
	10 poles
Coloured partition	red, green, white
Cross connection barrier	red
Marking tag	printed or blank
End bracket	

Type	Cat. No.
CB/PT/GR	CB401GR
CB/PT	CB401
CB/PT (Ex)i	CB402
PTC/2/02	PTC0202
PTC/2/03	PTC0203
PTC/2/05	PTC0205
PTC/2/10	PTC0210
PTC/2/00 (50 poles)	PTC0200
DFU/3	DU03
DFM/800	DF800 - DF 900
DFM/900	DF800 - DF 900
CNU/8/51	NU0851
BTU for PR/DIN and PR/3	BT005
BT/DIN/PO for PR/DIN only	BT001
BT/3-BTO for PR/3 only	BT003-BT007

Type	Cat. No.
CB/PT/GR	CB401GR
CB/PT	CB401
CB/PT (Ex)i	CB402
PTC/4/02	PTC0402
PTC/4/03	PTC0403
PTC/4/05	PTC0405
PTC/4/10	PTC0410
PTC/4/00 (42 poles)	PTC0400
DFU/3	DU03
DFM/800	DF800 - DF 900
DFM/900	DF800 - DF 900
CNU/8/61	NU0861
BTU for PR/DIN and PR/3	BT005
BT/DIN/PO for PR/DIN only	BT001
BT/3-BTO for PR/3 only	BT003-BT007

Disconnects

- disconnects with special connections
- possibility to perform parallel connections
- available in multiple colours: grey and beige, or in a version appropriate for use with “intrinsically safe” circuits (blue)
- universal mounting for both PR/DIN and PR/3 rails which meet IEC 60715 norms, “G32” and TH/35 types
- “Easy Bridge” system: multi-polar cross connection without the need for additional protections
- maximum operating temperature 100°C



For the isolation figures with cross connections refer to the table on page 131

The /GR tag indicates the grey version.

grey version	
beige version	
(Ex)i version	
TECHNICAL CHARACTERISTICS	
function/type	
rated cross-section	(mm ²)
connecting capacity	
flexible	(mm ²)
rigid	(mm ²)
max. flexible with ferrule (mm ²) - ferrule type	
rated voltage / rated current / gauge	conf. to IEC 60947-7-1
rated voltage / rated current / AWG / tightening torque value	UL
(Ex e) rated voltage	(V)
rated impulse withstand voltage / pollution degree	
insulation stripping length	(mm)
tightening torque value (test / max)	(Nm)
height / width / thickness	TH/35 7,5 mm
height / width / thickness	TH/35 15 mm
height / width / thickness	G32

APPROVALS

ACCESSORIES	
End sections	grey beige blue
Permanent cross connection (pre-assembled) (intrinsically IPXXB protected once mounted)	
Rated current carrying capacity of jumper	(A)
Cross-connection identification strip (100 mm)	green
Multiple common bar	250 mm
Shunting screw and sleeve	
Coloured partition	red, green, white
Cross connection barrier	red
Test plug socket	
Test plug	
Numbering strip	
Cover for cross-connections	red, blue or white
Marking tag	printed or blank
End bracket	

MPS.4/GR	
Cat. No.	MP950GR
MPS.4	
Cat. No.	MP950
MPS.4/SW (Ex)i	
Cat. No.	MP960

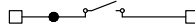

disconnect lever	
4	
0.2-6	
0.2-6	
4-WP40/16	
400 V / 24 A / A4	
600 V / 24 A / 26-10 AWG / 4.4 lb.in	
-	
6 KV / 3	
9	
0.5 / 1.2	
47 / 47 / 6	
55 / 47 / 6	
51 / 47 / 6	



DSS.4/GR	
Cat. No.	DS400GR
DSS.4	
Cat. No.	DS400

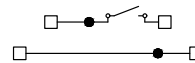

on two levels, with switchable upper circuit	
4	
0.2-6	
0.2-6	
4-WP40/16	
400 V / 24-32 A (*) / A4	
300 V / 24-32 A / 26-10 AWG / 4.4 lb.in	
-	
4 KV / 3	
9	
0.5 / 1.2	
68 / 78 / 6	
75 / 78 / 6	
72 / 78 / 6	



Type	Cat. No.
MPS.4/PT/GR	MP901GR
MPS.4/PT	MP901
MPS.4/PT (Ex)i	MP902
PTC/4/02 poles	PTC0402
PTC/4/03 poles	PTC0403
PTC/4/05 poles	PTC0405
PTC/4/10 poles	PTC0410
PTC/4/00 (42 poles)	PTC0400
32	
PTC/SP	PTC0990
-	
DFU/3	DU03..
DFM/500	DF500
-	
-	
CNU/8/61	NU0861
-	
CNU/8/51	NU0851
BTU for PR/DIN and PR/3	BT005
BT/DIN/PO for PR/DIN only	BT001
BT/3-BTO for PR/3 only	BT003-BT007

Type	Cat. No.
DSS/PT/GR	DS301GR
DSS/PT	DS301
PTC/4/02 poles	PTC0402
PTC/4/03 poles	PTC0403
PTC/4/05 poles	PTC0405
PTC/4/10 poles	PTC0410
PTC/4/00 (42 poles)	PTC0400
32	
PTC/SP	PTC0990
-	
-	
DFU/7	DU07..
DFM/500	DF500
-	
-	
CNU/8/61	NU0861
-	
CNU/8/51	NU0851
BTU for PR/DIN and PR/3	BT005
BT/DIN/PO for PR/DIN only	BT001
BT/3-BTO for PR/3 only	BT003-BT007

(*) values referred to the upper and lower conducting body, respectively

Disconnects

- disconnects by means of conducting element to be inserted in the lever
- disconnects with special connections
- universal mounting for both PR/DIN and PR/3 rails which meet IEC 60715 norms, "G32" and TH/35 types
- available in grey and beige
- maximum operating temperature 100°C



The terminal blocks are equipped with a hole suited for the sealing of the lever or for the insertion of a rod for the simultaneous opening of the lever of adjoining terminal blocks

To determine the insulation voltage related to the different connection diagrams with PTC cross connections, consult the table on page 131.

1 screw and 1 4 x 0.8 mm solder connection



Ø 5 x 20 mm CO/5 conducting element - in tin plated brass to be inserted in the lever

The /GR tag indicates the grey version.

grey version	
beige version	
(Ex)i version	
TECHNICAL CHARACTERISTICS	
function/type	
rated cross-section	(mm ²)
connecting capacity	
flexible	(mm ²)
rigid	(mm ²)
max. flexible with ferrule (mm ²) - ferrule type	
rated voltage / rated current / gauge	conf. to IEC 60947-7-1
rated voltage / rated current / AWG / tightening torque value	UL
(Ex e) rated voltage	(V)
rated impulse withstand voltage / pollution degree	
insulation stripping length	(mm)
tightening torque value (test / max)	(Nm)
height / width / thickness	TH/35 7,5 mm
height / width / thickness	TH/35 15 mm
height / width / thickness	G32

SFR.4/GR	Cat. No. SF900GR
SFR.4	Cat. No. SF900
SFR.4 (Ex)i	Cat. No. SF850



disconnect	4
0.2-6	
0.2-6	
4-WP40/16	
800 V / 20 A (with CO/5) / A4	
600 V / 6.3 A / 20-12 AWG / 4.4 lb.in	
-	
6 kV / 3	
11	
0.5 / 1.2	
52 / 52 / 8	
60 / 52 / 8	
56 / 52 / 8	



SFR.4/VS/GR	Cat. No. SF910GR
SFR.4/VS	Cat. No. SF910

FOR 5 x 20 FUSE WITH SOLDER LUG

disconnect, with solder lug	4
0.2-6	
0.2-6	
4-WP40/16	
400 V / 15 A (with CO/5) / A4	
-	
4 kV / 3	
11	
0.5 / 1.2	
52 / 65 / 8	
60 / 65 / 8	
56 / 65 / 8	



SFR.6/M/GR	Cat. No. SR500GR
SFR.6/M	Cat. No. SR500
SFR.6/M (Ex)i	Cat. No. SR600

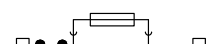

disconnect	6
0.2-10	
0.2-10	
4-WP60/20	
630 V / 19 A (with CO/5) / A5	
600 V / 6.3 A / 20-8 AWG / 13 lb.in.	
-	
6 kV / 3	
11	
0.8 / 1.4	
59 / 79 / 10	
67 / 79 / 10	
63 / 79 / 10	



APPROVALS

ACCESSORIES	
End sections	grey beige blue
Permanent cross connection (pre-assembled)	
Switchable cross connection	
Multiple common bar	250 mm
Shunting screw and sleeve	
Coloured partition	red, green, white
Cross connection barrier	red
Test plug socket	
Test plug	
Numbering strip	
MSM handle	
Brass conducting element	
Marking tag	printed or blank
End bracket	

Type	Cat. No.
SFR.4/PT/GR	SF701GR
SFR.4/PT	SF701
SFR.4/PT (Ex)i	SF801
-	
-	
DFU/3	DU03..
-	
-	
CO/5	VL103
CNU/8/51	NU0851
BTU for PR/DIN and PR/3	BT005
BT/DIN/PO for PR/DIN only	BT001
BT/3-BTO for PR/3 only	BT003-BT007

Type	Cat. No.
SFR.4/PT/GR	SF701GR
SFR.4/PT	SF701
-	
-	
DFU/3	DU03..
-	
-	
CO/5	VL103
CNU/8/51	NU0851
BTU for PR/DIN and PR/3	BT005
BT/DIN/PO for PR/DIN only	BT001
BT/3-BTO for PR/3 only	BT003-BT007

Type	Cat. No.
SFR.6/PT/GR	SR301GR
SFR.6/PT	SR301
SFR.6/PT (Ex)i	SR401
PTC/20/02 poles (*)	PTC2002
PTC/20/03 poles (*)	PTC2003
PTC/20/05 poles (*)	PTC2005
PTC/20/10 poles (*)	PTC2010
PTC/20/00 (25 poles) (*)	PTC2000
25	
-	
-	
DFU/7	DU07..
DFM/300	DF300
-	
SDD/1	DD001
-	
CO/5	VL103
CNU/8/51	NU0851
BTU for PR/DIN and PR/3	BT005
BT/DIN/PO for PR/DIN only	BT001
BT/3-BTO for PR/3 only	BT003-BT007

Disconnects

- disconnects by means of conducting element to be inserted in the lever
- slide link disconnect
- possibility to perform parallel connections
- universal mounting for both PR/DIN and PR/3 rails which meet IEC 60715 norms, "G32" and TH/35 types
- available in grey and beige
- maximum operating temperature 100°C



Please refer to the table on page 131 in order to determine the insulation voltage of the different PTC connection diagrams



Ø 6.3 x 32 mm CO/5 conducting element - in tin plated brass to be inserted in the lever

SCB.4 terminal blocks with shortcircuit plates and test plugs



The /GR tag indicates the grey version.

grey version
beige version
(Ex)i version

TECHNICAL CHARACTERISTICS

function/type	
rated cross-section	(mm ²)
connecting capacity	
flexible	(mm ²)
rigid	(mm ²)
max. flexible with ferrule (mm ²) - ferrule type	
rated voltage / rated current / gauge	conf. to IEC 60947-7-1
rated voltage / rated current / AWG / tightening torque value	UL
(Ex e) rated voltage	(V)
rated impulse withstand voltage / pollution degree	
insulation stripping length	(mm)
tightening torque value (test / max)	(Nm)
height / width / thickness	TH/35 7.5 mm
height / width / thickness	TH/35 15 mm
height / width / thickness	G32

SFR.6/GR	Cat. No. SR300GR
SFR.6	Cat. No. SR300
SFR.6 (Ex)i	Cat. No. SR400

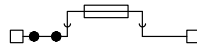

disconnect	6
flexible	0.2-10
rigid	0.2-10
max. flexible with ferrule	6-WP60/20
rated voltage / rated current / gauge	630 V / 33 A (with cylinder) / A5
rated voltage / rated current / AWG / tightening torque value	600 V / 10 A / 20-8 AWG / 13 lb.in
(Ex e) rated voltage	-
rated impulse withstand voltage / pollution degree	6 kV / 3
insulation stripping length	11
tightening torque value (test / max)	0.8 / 1.4
height / width / thickness	59 / 79 / 10
height / width / thickness	67 / 79 / 10
height / width / thickness	63 / 79 / 10



FPC.10	Cat. No. FP100
---------------	-----------------------

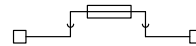

disconnect	10
flexible	1.5-16
rigid	1.5-16
max. flexible with ferrule	10-WP100/21
rated voltage / rated current / gauge	800 V / 20 A (with SFC/CO) / B6
rated voltage / rated current / AWG / tightening torque value	600 V / 15 A / 20-6 AWG / 7 lb.in
(Ex e) rated voltage	-
rated impulse withstand voltage / pollution degree	6 kV / 3
insulation stripping length	17
tightening torque value (test / max)	1.2 / 1.9
height / width / thickness	70 / 63 / 12
height / width / thickness	74 / 63 / 12
height / width / thickness	78 / 63 / 12



SCB.4/GR	Cat. No. SB300GR
SCB.4	Cat. No. SB300

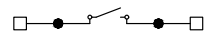

disconnect by slide link	4
flexible	0.2-6
rigid	0.2-6
max. flexible with ferrule	4-WP40/16
rated voltage / rated current / gauge	800 V / 32 A / A4
rated voltage / rated current / AWG / tightening torque value	600 V / 20 A / 20-12 AWG / 4.4 lb.in
(Ex e) rated voltage	-
rated impulse withstand voltage / pollution degree	8 kV / 3
insulation stripping length	9
tightening torque value (test / max)	0.5 / 1.2
height / width / thickness	44 / 58 / 6.5
height / width / thickness	52 / 58 / 6.5
height / width / thickness	48 / 58 / 6.5



APPROVALS

ACCESSORIES	
End sections	grey beige blue
Permanent cross connection (pre-assembled)	
(*) intrinsically IPXXB protected once mounted	
Rated current carrying capacity of jumper	(A)
Switchable cross connection	
Cross-connection identification strip (100 mm)	green
Multiple common bar	250 mm
Shunting screw and sleeve	
Coloured partition	red, green, white
Cross connection barrier	red
Test plug socket	
Test plug	
Short-circuit plate	between 2 adjoining terminal blocks between 4 adjoining terminal blocks
Numbering strip	
Brass conducting element	
Screw and sleeve for short-circuit plates	
MSM handle	
Marking tag	printed or blank
End bracket	

Type	Cat. No.
SFR.6/PT/GR	SR301GR
SFR.6/PT	SR301
SFR.6/PT (Ex)i	SR401
PTC/20/02 poles (*)	PTC2002
PTC/20/03 poles (*)	PTC2003
PTC/20/05 poles (*)	PTC2005
PTC/20/10 poles (*)	PTC2010
PTC/20/00 (25 poles) (*)	PTC2000
25	
PTC/SP	PTC0990
DFU/7	DU07..
DFM/300	DF300
SDD/1	DD001
CO/6	CO06
CNU/8/51	NU0851
BTU for PR/DIN and PR/3	BT005
BT/DIN/PO for PR/DIN only	BT001
BT/3-BTO for PR/3 only	BT003-BT007

Type	Cat. No.
-	
-	
-	
-	
-	
DFU/6	DU06..
-	
SDD/2	DD002
-	
SFC/CO	FC102
MSM (6 elements)	FC103
CNU/8/51	NU0851
BTU for PR/DIN and PR/3	BT005
BT/DIN/PO for PR/DIN only	BT001
BT/3-BTO for PR/3 only	BT003-BT007

Type	Cat. No.
SCB/4/PT/GR	SB301GR
SCB/4/PT	SB301
PM/40/2 poles	PM402
PM/40/3 poles	PM403
PM/40/5 poles	PM405
PM/40/10 poles	PM410
32	
POS/12	POS12
PMP/42	PMP42
CPM/12	CPM12
DFU/3	DU03..
PSD/A	PD001
SDD/6-SDD/1	DD006-DD001
SCB/4/PO/2	SB303
SCB/4/PO/4	SB304
SCB/4/CPM	SB305
CNU/8/51	NU0851
BTU for PR/DIN and PR/3	BT005
BT/DIN/PO for PR/DIN only	BT001
BT/3-BTO for PR/3 only	BT003-BT007

Disconnect terminal blocks for test and measurement circuits

with UL94V-0 polyamide insulating body

- universal mounting for both PR/DIN and PR/3 rails which meet IEC 60715 norms, "G32" and TH/35 types

In SCB.6 type terminal block, the use of special cross-connections, formed by

SCB/6/PO/2 (between 2 adjoining terminal blocks)



or **SCB/6/PO/4** (between 4 adjoining terminal blocks)



and by the relevant **SCB/6/CPM** shunting screws



allow the simultaneous earth connection of the current transformers connected to the terminal blocks themselves, guaranteeing the correct operational sequence. In fact such cross connections, in opened position, avoid the translation on the slide links, already connected in an accident prevention position from the outside; they do not require the insertion of further partitions to separate them from other adjoining cross-connections or terminal blocks, due to the special shape of the insulating body of the terminal block itself.

SCB.6 type terminal blocks have also the possibility to house, upstream and downstream the disconnection, sockets for test plugs, suitable for the withdraw of signals.

In particular the shunts can take place:

- on **SCB/CPM** shunting screws of the short-circuit plates
- on **PSD/P** socket to be screwed directly into the conducting body of the terminal block, in order to perform the shunting function.

The slide-link is formed by two guides, held together by a screw inserted in a glass-shape collar, which allows the elastic blocking and the anti-loosening of the slide-link and is provided with a red protective colouring for the easy positioning of the screwdriver during the disconnection and the easy spotting of the slide-link itself.

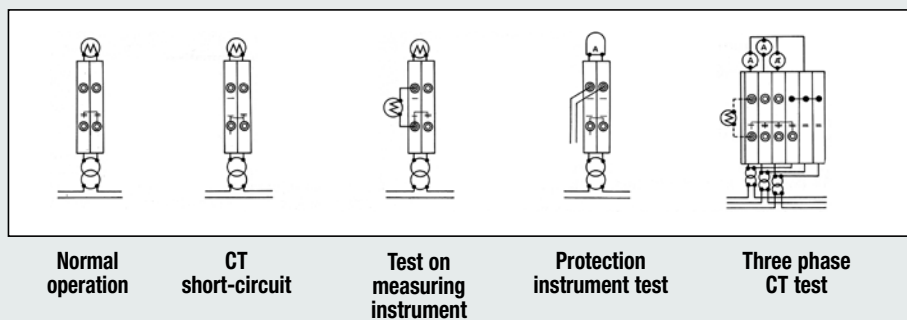
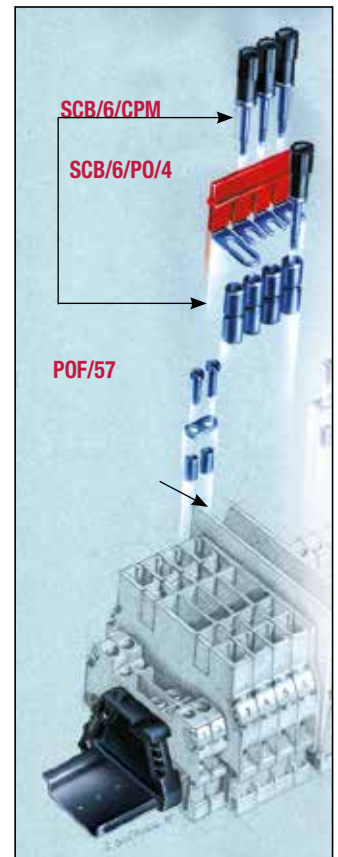

Disconnect terminal blocks for test and measurement circuits

- universal mounting for both PR/DIN and PR/3 rails which meet IEC 60715 norms, "G32" and TH/35 types
- available in grey and beige
- maximum operating temperature 100°C

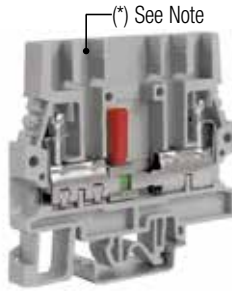

(*) For the simple connection in parallel of two or more adjoining terminal blocks use the parallel skid, with the screws and sleeves, after removing the insulating wall with a simple cutter

Longitudinal and transversal test switching terminal block. Configuration complete with **test plug socket** downstream and upstream the slide link, compliant with the ENEL LV 27/3 specifications

Longitudinal and transversal test switching terminal block. Configuration complete with **a test plug socket** upstream and **a short circuit sleeve** SCB/6/PO/2 or SCB/PO/4 type, supplied separately, downstream of the slide link, compliant with the ENEL LV 27/2 specifications

The /GR tag indicates the grey version.

grey version
beige version
(Ex)i version

TECHNICAL CHARACTERISTICS

function/type	
rated cross-section	(mm ²)
connecting capacity	
flexible	(mm ²)
rigid	(mm ²)
max. flexible with ferrule (mm ²) - ferrule type	
rated voltage / rated current / gauge	conf. to IEC 60947-7-1
rated voltage / rated current / AWG / tightening torque value	UL
(Ex e) rated voltage	(V)
rated impulse withstand voltage / pollution degree	
insulation stripping length	(mm)
tightening torque value (test / max)	(Nm)
height / width / thickness	TH/35 7.5 mm
height / width / thickness	TH/35 15 mm
height / width / thickness	G32

SCB.6/GR	Cat. No. SB200GR
SCB.6	Cat. No. SB200

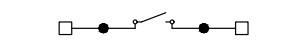

disconnect by slide link	
6	
0.5–10	
0.5–10	
6–WP60/20	
800 V / 41 A / A5	
600 V / 47 A / 20-8 AWG / 13.3 lb.in.	
-	
8 KV / 3	
12	
0.8 / 1.4	
65 / 69 / 8	
73 / 69 / 8	
68 / 69 / 8	



SCB.6/DD/GR	Cat. No. SB210GR
SCB.6/DD	Cat. No. SB210

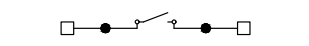

disconnect by slide link in special configuration for voltmetric circuits	
6	
0.5–10	
0.5–10	
6–WP60/20	
800 V / 41 A / A5	
-	
8 KV / 3	
12	
0.8 / 1.4	
76 / 69 / 8	
84 / 69 / 8	
79 / 69 / 8	



SCB.6/CD/GR	Cat. No. SB220GR
SCB.6/CD	Cat. No. SB220

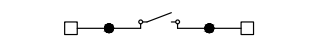

disconnect by slide link in special configuration for amperometric circuits	
6	
0.5–10	
0.5–10	
6–WP60/20	
800 V / 41 A / A5	
-	
8 KV / 3	
12	
0.8 / 1.4	
77 / 69 / 8	
85 / 69 / 8	
80 / 69 / 8	



APPROVALS

ACCESSORIES

End sections	grey beige blue
Permanent cross connection (pre-assembled) (* intrinsically IPXXB protected once mounted)	
Switchable cross connection	
Multiple common bar	250 mm
Shunting screw and sleeve	
Coloured partition	red, green, white
Cross connection barrier	red
Test plug socket	
Test plug	
Numbering strip	
Cover for cross-connection	
Short-circuit plate	between 2 adjoining terminal blocks between 4 adjoining terminal blocks
Screw and sleeve for short-circuit plates	black
Screw and sleeve for short-circuit plates	red
Marking tag	printed or blank
End bracket	

Type	Cat. No.
SCB/6/PT/GR	SB201GR
SCB/6/PT	SB201
-	
POF/57	POF57
-	
PMP/13	PMP13
CPM/57	CPM57
DFU/6	DU06..
-	
PSD/P	PD015
SDD/2	DD002
-	
SCB/6/PO/2	SB203
SCB/6/PO/4	SB204
SCB/6/CPM	SB205
SCB/6/CPM/R	SB205R
CNU/8/51	NU0851
BTU for PR/DIN and PR/3	BT005
BT/DIN/PO for PR/DIN only	BT001
BT/3-BTO for PR/3 only	BT003-BT007

Type	Cat. No.
SCB/6/PT/GR	SB201GR
SCB/6/PT	SB201
-	
POF/57	POF57
-	
PMP/13	PMP13
CPM/57	CPM57
DFU/6	DU06..
-	
2 pcs. included	
SDD/2	DD002
-	
SCB/6/PO/2	SB203
SCB/6/PO/4	SB204
Not available for this model	
CNU/8/51	NU0851
BTU for PR/DIN and PR/3	BT005
BT/DIN/PO for PR/DIN only	BT001
BT/3-BTO for PR/3 only	BT003-BT007

Type	Cat. No.
SCB/6/PT/GR	SB201GR
SCB/6/PT	SB201
-	
POF/57	POF57
-	
PMP/13	PMP13
CPM/57	CPM57
DFU/6	DU06..
-	
1 pc. included	
SDD/2	DD002
-	
SCB/6/PO/2	SB203
SCB/6/PO/4	SB204
1 pc. included	
CNU/8/51	NU0851
BTU for PR/DIN and PR/3	BT005
BT/DIN/PO for PR/DIN only	BT001
BT/3-BTO for PR/3 only	BT003-BT007

Disconnect terminal blocks for test and measurement circuits

- universal mounting for both PR/DIN and PR/3 rails which meet IEC 60715 norms, "G32" and TH/35 types
- configurations prepared /DD (with derivation sockets upstream and downstream of the slide link) - for voltammetric circuits
- configurations prepared /CD (with derivation sockets upstream and downstream of the slide link and sleeve for short circuit upstream of the slide link) - for amperometric circuits
- available in beige and grey
- maximum operating temperature 100°C

The /GR tag indicates the grey version.



grey version
beige version
(Ex)i version

TECHNICAL CHARACTERISTICS

function/type	
rated cross-section	(mm ²)
connecting capacity	
flexible	(mm ²)
rigid	(mm ²)
max. flexible with ferrule (mm ²) - ferrule type	
rated voltage / rated current / gauge	conf. to IEC 60947-7-1
rated voltage / rated current / AWG / tightening torque value	UL
(Ex e) rated voltage	(V)
rated impulse withstand voltage / pollution degree	
insulation stripping length	(mm)
tightening torque value (test / max)	(Nm)
height / width / thickness	TH/35 7.5 mm
height / width / thickness	TH/35 15 mm
height / width / thickness	G32

SCB.10/GR	Cat. No. SB400GR
SCB.10	Cat. No. SB400

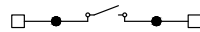

disconnect by slide link	
10	
0.5-16	
0.5-16	
10-WP100/21	
1000 V / 57 A / A4	
-	
-	
8 kV / 3	
14	
0.5 / 1.2	
59.5 / 75 / 10.5	
67.5 / 75 / 10.5	
63.5 / 75 / 10.5	

SCB.10/DD/GR	Cat. No. SB410GR
SCB.10/DD	Cat. No. SB410

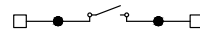

disconnect by slide link in special configuration for voltmetric circuits	
10	
0.5-16	
0.5-16	
10-WP100/21	
1000 V / 57 A / A4	
-	
-	
8 kV / 3	
14	
0.5 / 1.2	
59.5 / 75 / 10.5	
67.5 / 75 / 10.5	
63.5 / 75 / 10.5	

SCB.10/CD/GR	Cat. No. SB420GR
SCB.10/CD	Cat. No. SB420

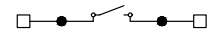

disconnect by slide link in special configuration for amperometric circuits	
10	
0.5-16	
0.5-16	
10-WP100/21	
1000 V / 57 A / A4	
-	
-	
8 kV / 3	
14	
0.5 / 1.2	
59.5 / 75 / 10.5	
67.5 / 75 / 10.5	
63.5 / 75 / 10.5	

APPROVALS



ACCESSORIES

End sections	grey beige
Permanent cross connection	
Multiple common bar	250 mm
Shunting screw and sleeve	
Coloured partition	red, green, white
Cross connection barrier	red
Test plug socket	
Test plug	
Numbering strip	
Screw and sleeve for short-circuit plates	black
Short-circuit plate	between 2 adjoining terminal blocks between 4 adjoining terminal blocks
Marking tag	printed or blank
End bracket	

Type	Cat. No.
SCB/10/PT/GR	SB401GR
SCB/10/PT	SB401
-	-
POF/56	POF56
PMP/56	PMP56
CPM/56	CPM56
DFU/7	DU07..
-	-
PSD/L	PD009
SDD/2	DD002
-	-
SCX/CPM	SC105
SCX/PO/2	SC103
SCX/PO/4	SC104
CNU/8/51	NU0851
-	-
BTU for PR/DIN and PR/3	BT005
BT/DIN/PO for PR/DIN only	BT001
BT/3-BT0 for PR/3 only	BT003-BT007

Type	Cat. No.
SCB/10/PT/GR	SB401GR
SCB/10/PT	SB401
-	-
POF/56	POF56
PMP/56	PMP56
CPM/56	CPM56
DFU/7	DU07..
-	-
2 pcs. included	
SDD/2	DD002
-	-
Not available	
SCX/PO/2	SC103
SCX/PO/4	SC104
CNU/8/51	NU0851
-	-
BTU for PR/DIN and PR/3	BT005
BT/DIN/PO for PR/DIN only	BT001
BT/3-BT0 for PR/3 only	BT003-BT007

Type	Cat. No.
SCB/10/PT/GR	SB401GR
SCB/10/PT	SB401
-	-
POF/56	POF56
PMP/56	PMP56
CPM/56	CPM56
DFU/7	DU07..
-	-
1 pcs. included	
SDD/2	DD002
-	-
1 pc. included	
SCX/PO/2	SC103
SCX/PO/4	SC104
CNU/8/51	NU0851
-	-
BTU for PR/DIN and PR/3	BT005
BT/DIN/PO for PR/DIN only	BT001
BT/3-BT0 for PR/3 only	BT003-BT007

Diode-holders

- for 1 A diodes (types 1N4001 – 1N4007)
- for 3 A diodes (type BY 255)
- universal mounting for both PR/DIN and PR/3 rails which meet IEC 60715 norms, "G32" and TH/35 types
- available in grey and beige
- maximum operating temperature 100°C

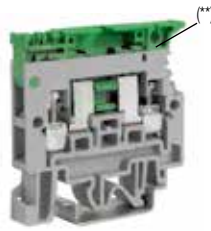

The terminal block is fitted with a disconnection lever with hole (**) provided for possible sealing of the knife or for inserting a pawl for moving simultaneously several contiguous knives



The terminal block is fitted with a disconnection lever with hole (**) provided for possible sealing of the knife or for inserting a pawl for moving simultaneously several contiguous knives

The SFR/1A or SFR/3A insert is provided as an accessory and must be mounted in the lever of the SFR.4 basic terminal block, to transform it into a diode holder

(*) value referred to the insulation characteristics of the terminal block

The /GR tag indicates the grey version.

grey version
beige version

SFR.4/GR	Cat. No. SF900GR
SFR.4	Cat. No. SF900

SFR.4/D1/GR	Cat. No. SF901GR
complete with diode 1N4001	
SFR.4/D3/GR	Cat. No. SF903GR
complete with diode 1N4007	
SFR.4/D1	Cat. No. SFR901
complete with diode 1N4001	
SFR.4/D3	Cat. No. SFR903
complete with diode 1N4007	

TECHNICAL CHARACTERISTICS	
function/type	
rated cross-section	(mm ²)
connecting capacity	
flexible	(mm ²)
rigid	(mm ²)
max. flexible with ferrule (mm ²) - ferrule type	
rated voltage / rated current / gauge	conf. to IEC 60947-7-1
rated voltage / rated current / AWG / tightening torque value	UL
(Ex e) rated voltage	(V)
rated impulse withstand voltage / pollution degree	
insulation stripping length	(mm)
tightening torque value (test / max)	(Nm)
height / width / thickness	TH/35 7.5 mm
height / width / thickness	TH/35 15 mm
height / width / thickness	G32

	for 1 A or 3 A diodes
	4
	0.2-6
	0.2-6
	4-WP40/16
	800 V (*) / 1 (3) A / A4
	-
	6 KV (*) / 3
	11
	0.5 / 1.2
	52 / 52 / 8
	60 / 52 / 8
	56 / 52 / 8

	with 1 A or 3 A diode
	4
	0.2-6
	0.2-6
	4-WP40/16
	800 V (*) / 1 (3) A / A4
	-
	6 KV (*) / 3
	11
	0.5 / 1.2
	52 / 52 / 8
	60 / 52 / 8
	56 / 52 / 8

APPROVALS



ACCESSORIES	
End sections	grey beige blue
Permanent cross connection	
Switchable cross connection	
Multiple common bar	250 mm
Shunting screw and sleeve	
Coloured partition	red, green, white
Cross connection barrier	red
Test plug socket	
Test plug	
Numbering strip	
Miniature fuse	
Conducting element	
Cartridge / insert with 1 A diode	
Cartridge / insert with 3 A diode	
Marking tag	printed or blank
End bracket	

Type	Cat. No.
SFR/PT/GR	SF701GR
SFR/PT	SF701
SFR/PT (Ex)i	SF801
-	-
-	-
-	-
DFU/3	DU03..
-	-
-	-
-	-
-	-
SFR/11A (with 1 A diode)	SF992
SFR/13A (with 3 A diode)	SF993
CNU/8/51	NU0851
BTU for PR/DIN and PR/3	BT005
BT/DIN/PO for PR/DIN only	BT001
BT/3-BTO for PR/3 only	BT003-BT007

Type	Cat. No.
SFR/PT/GR	SF701GR
SFR/PT	SF701
SFR/PT (Ex)i	SF801
-	-
-	-
-	-
DFU/3	DU03..
-	-
-	-
-	-
F5	FN...
-	-
SFR/11A (with 1 A diode)	SF992
SFR/13A (with 3 A diode)	SF993
CNU/8/51	NU0851
BTU for PR/DIN and PR/3	BT005
BT/DIN/PO for PR/DIN only	BT001
BT/3-BTO for PR/3 only	BT003-BT007

With electronic components

- with cross-connection possibility
- universal mounting onto both PR/DIN and PR/3 type rails - according to IEC 60715 standard
- two and three level circuits with bidirectional suppressor diode
- protection against overvoltage, transistor, pulse jamming
- class D protection according to standard DIN VDE 0675. 1989
- overvoltage category <1.5 kV, I (DIN VDE 0110.1)
- available in grey and beige

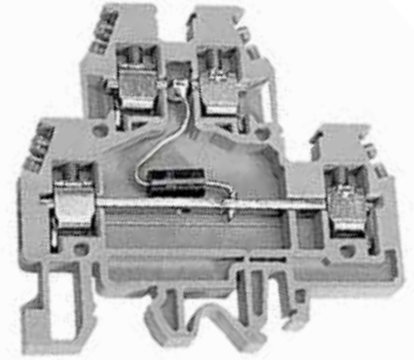

The **DAS.4...D** terminal blocks with suppressor diodes inserted as in **diagram 3**, limit voltage peaks due to surges, electrostatic discharges and switching of inductive loads, and enable the equipment to pass the tests on immunity to electromagnetic interferences defined by the EN 61000-4-2 (Electrostatic discharge), EN 61000-4-4 (Fast Transient/Burst) and EN 61000-4-5 (Surge Test) Standards. The suppressor diodes have an intervention time (<1 ns) much faster than the intervention time of varistors (approximately 25 ns) and a lower and more precise intervention voltage, but compared to these withstand lower discharge currents.

The great precision of the intervention voltage and the great speed, makes them suitable for protecting industrial PLC, DCS, PC I/O signal ports, against voltage interferences and discharge currents lower than 500A impulse 8/20µs. This type of interference is usually caused by the normal operation of the plants themselves, owing to the switching of strong inductive loads, dispersed currents, faults, etc...

The range of models available makes it possible to choose between nominal voltages suitable for protecting signals with standard voltages of 5Vdc, 12Vdc, 24Vdc and 60Vdc. The **DAS.4...D** connected as in **diagram 4** is an effective protection against differential mode interferences for industrial PLC, DCS, PC inputs and outputs, signal conditioners and sensors, and also for stabilised direct current power supplies of electronic equipment in general.

The **DAS.4...D** does not have a signal wiring direction to be observed, as also the connection of the positive and negative polarities can be made either on the lower or the upper level.

Differential mode interference (diagram 5): these generate a great difference of potential between the two conductors of a signal (positive and negative of the twisted pair) or of a power supply, and as they are applied directly to the input/output circuits of the device, they always cause a fault in the same.

Common mode interference (diagram 6): these generate a great difference of potential between the two signal or power supply conductors and the reference earth. They are less destructive than differential mode interferences.

Caution: inserting surge protection devices with varistors, diodes and other components between the signal and/or power supply conductors and the protection earth reduces the insulation voltage approximately to the V breakdown value of the discharger used; to perform insulation tests on the equipment, disconnect the dischargers (IEC EN 60950 Standard).

grey version	
beige version	
ACCESSORIES	
End sections	grey beige blue
Permanent cross connection (pre-assembled)	
Switchable cross connection	
Multiple common bar	250 mm
Shunting screw and sleeve	
Coloured partition	red, green, white
Cross connection barrier	red
Test plug socket	
Test plug	
Modular test plug	
End section for modular test plug	
Numbering strip	
Warning plate	on adjacent terminal blocks
Cover for cross-connections	red, blue or white
Marking tag	printed or blank
End bracket	

DAS.4/6/D.../GR	
DAS.4/6/D...	
Type	Cat. No.
DAS/PT/GR	DS101GR
DAS/PT	DS101
-	-
PM/41/2 poles	PM412
PM/51/3 poles	PM513
PM/51/5 poles	PM515
PM/51/10 poles	PM510
POS/43	POS43
PMP/58	PMP58
CPM/01	CPM01
DFU/7	DU07..
-	-
PSD/A	PD001
SDD/1	DD001
-	-
-	-
CNU/8/61	NU0861
-	-
PRP/5	PRP05
CNU/8/51	NU0851
BTU for PR/DIN and PR/3	BT005
BT/DIN/PO for PR/DIN only	BT001
BT/3-BTO for PR/3 only	BT003-BT007

Note for wiring: wiring of the power surge protection devices greatly influences their actual efficacy and we recommend following the instructions below:

- the protection device must be placed as close as possible to the equipment to be protected;
- the connection wires must be as short and straight as possible, interwoven with each other and with the largest possible cross section;
- the earth conductors between common mode dischargers and the equipotential busbar must be as short as possible and with the largest possible cross section and their path must not be parallel to other conductors. The earth of the protected equipment must be connected to the same earth of its discharger and from there to the general protection earthing.

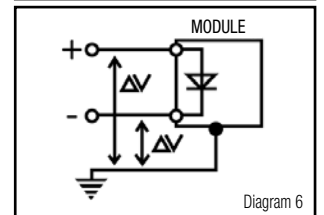
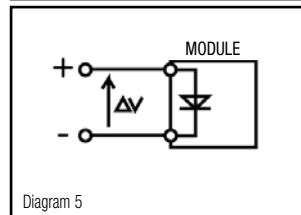
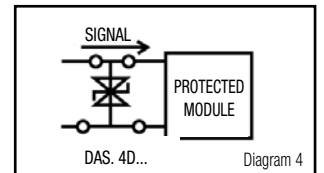
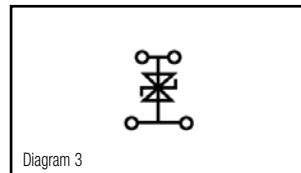

Differential mode interference. The potential difference is applied between positive and negative poles of the power supply signal.

Common mode interference. The potential difference is applied between the poles of the signal/power supply unit and the earth.

With electronic components

- with cross-connection possibility on lower level
- universal mounting for both PR/DIN and PR/3 rails which meet IEC 60715 norms, "G32" and TH/35 types
- two and three level circuits with bidirectional suppressor diode
- protection against overvoltage, transistor, pulse jamming
- class D protection according to standard DIN VDE 0675
- overvoltage category <1.5 kV, I (DIN VDE 0110.1)
- available in grey and beige



(*) values referred to the characteristics of the connection
The /GR tag indicates the grey version.

grey version	DAS.4/D.../GR
beige version	DAS.4/D...
TECHNICAL CHARACTERISTICS	
function/type	diagram
rated cross-section (mm ²)	4
connecting capacity	
flexible (mm ²)	0.2-6
rigid (mm ²)	0.2-6
max. flexible with ferrule (mm ²) - ferrule type	4-WP40/16
rated voltage / rated current / gauge conf. to IEC 60947-7-1	630 V / 32 A / A4 (*)
rated voltage / rated current / AWG / tightening torque value UL	-
rated impulse withstand voltage / pollution degree	8 KV / 3
insulation stripping length (mm)	9
tightening torque value (test / max) (Nm)	0.5 / 1.2
height / width / thickness TH/35 7.5 mm	62 / 64 / 6
height / width / thickness TH/35 15 mm	70 / 64 / 6
height / width / thickness G32	66 / 64 / 6

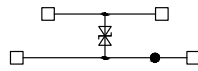

APPROVALS



TECHNICAL DATA	DAS.4/D5/GR Cat. No. DSD005GR	DAS.4/D12/GR Cat. No. DSD012GR	DAS.4/D24/GR Cat. No. DSD024GR	DAS.4/D60/GR Cat. No. DSD060GR
	DAS.4/D5 Cat. No. DSD005	DAS.4/D12 Cat. No. DSD012	DAS.4/D24 Cat. No. DSD024	DAS.4/D60 Cat. No. DSD060
Rated voltage	5	12	24	60
Vdc max. (Vcc)	6.45	15.2	28.5	77.9
Vac max.	-	-	-	-
Breakdown voltage(1 mA)	6.8 V ± 5%	16 V ± 5%	30 V ± 5%	82 V ± 5%
Max clamping voltage (V)	11	23	41	113
Response time	< 1 ns	< 1 ns	< 1 ns	< 1 ns
ISC pulse /20 μs (A)	750	350	160	70
C (1 kHz)	5 nF	3 nF	1.5 nF	0.6 nF

With electronic components

- two and three level circuits with varistor
- with cross-connection possibility on lower level
- protection against overvoltage, transistor, pulse jamming
- class D protection according to DIN VDE 0675
- overvoltage category <2.5 kV, I (acc. to DIN VDE 0110.1)
- available in grey and beige



The **DAS.4V...** terminal blocks with varistor inserted as in **diagram 1**, limit voltage peaks due to surges, indirect atmospheric discharges and switching of inductive loads, and enable the equipment to pass the tests on immunity to electromagnetic interferences defined by the EN 61000-4-2 (Electrostatic discharge), EN 61000-4-4 (Fast Transient/Burst) and EN 61000-4-5 (Surge Test) Standards.

Varistors have an intervention time (20-25 ns) much longer than the intervention time of suppressor diodes (<1 ns) and a higher intervention voltage, but compared to these withstand higher discharge currents. The high discharge current makes them suitable for use in the presence of strong transients, with currents of up to 4500 A impulse 8/20 s.

The range of models available makes it possible to choose between nominal voltages suitable for protecting both signals and power supplies with standard voltages of 24 V DC, 48 V DC, or for power supply voltages of 120 V AC and 230 V AC.

The **DAS.4V...** connected as in **diagram 2** is an effective protection against differential mode interferences for industrial PLC, DCS, PC inputs and outputs, signal conditioners and sensors, and also for power supplies of electronic equipment in general.

The **DAS.4V...** does not have a signal wiring direction to be observed, as also the connection of the positive and negative polarities can be made either on the lower or the upper level.

The **/GR** tag indicates the grey version.

grey version	DAS.4/V.../GR
beige version	DAS.4/V...
TECHNICAL CHARACTERISTICS	
function/type	diagram 4
rated cross-section (mm ²)	4
connecting capacity	
flexible (mm ²)	0.2-6
rigid (mm ²)	0.2-6
max. flexible with ferrule (mm ²) - ferrule type	4-WP40/16
rated voltage / rated current / gauge conf. to IEC 60947-7-1	630 V / 32 A / A4 (*)
rated voltage / rated current / AWG / tightening torque value UL	-
rated impulse withstand voltage / pollution degree	8 KV / 3
insulation stripping length (mm)	9
tightening torque value (test / max) (Nm)	0.5 / 1.2
height / width / thickness TH/35 7.5 mm	62 / 64 / 6
height / width / thickness TH/35 15 mm	70 / 64 / 6
height / width / thickness G32	66 / 64 / 6

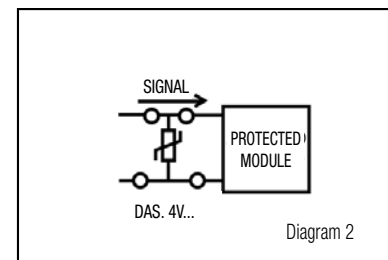
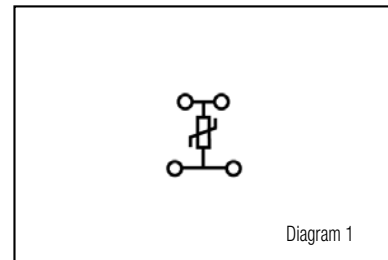

APPROVALS



TECHNICAL DATA	DAS.4/V24/GR	DAS.4/V48/GR	DAS.4/V120/GR	DAS.4/V230/GR
	Cat. No. DSV024GR	Cat. No. DSV048GR	Cat. No. DSV120GR	Cat. No. DSV230GR
	DAS.4/V24	DAS.4/V48	DAS.4/V120	DAS.4/V230
	Cat. No. DSV024	Cat. No. DSV048	Cat. No. DSV120	Cat. No. DSV230
Rated voltage	24	48	120	230
Vdc max. (Vcc)	31	85	180	350
Vac max.	25 V AC	60 V AC	140 V AC	275 V AC
Breakdown voltage(1 mA)	39 V ± 10%	100 V ± 10%	220 V ± 10%	430 V ± 10%
Max clamping voltage (V)	77 V	165 V	360 V	710 V
Response time	< 25 ns	< 25 ns	< 25 ns	< 25 ns
ISC pulse /20 µs (A)	500	2500	2500	2500
C (1 kHz)	4600 pF	1650 pF	610 pF	320 pF

With electronic components

- two and three level circuits
- possibility to perform cross-connections on both lower and upper levels (DAS.4/A and DAS.4/B; other versions only lower level)
- available in grey and beige



DAS.4/C terminal block

The /GR tag indicates the grey version.

grey version	
beige version	
TECHNICAL CHARACTERISTICS	
function/type	
rated cross-section	(mm ²)
connecting capacity	
flexible	(mm ²)
rigid	(mm ²)
max. flexible with ferrule (mm ²) - ferrule type	
rated voltage / rated current / gauge	conf. to IEC 60947-7-1
rated voltage / rated current / AWG / tightening torque value	UL
(Ex e) rated voltage	(V)
rated impulse withstand voltage / pollution degree	
insulation stripping length	(mm)
tightening torque value (test / max)	(Nm)
height / width / thickness	TH/35 7.5 mm
height / width / thickness	TH/35 15 mm
height / width / thickness	G32

APPROVALS



ACCESSORIES	
End sections	grey beige blue
Permanent cross connection (pre-assembled)	
Switchable cross connection	
Multiple common bar	250 mm
Shunting screw and sleeve	
Coloured partition	red, green, white
Cross connection barrier	red
Test plug socket	
Test plug	
Modular test plug	
End section for modular test plug	
Numbering strip	
Warning plate	on adjacent terminal blocks
Cover for cross-connections	red, blue or white
Marking tag	printed or blank
End bracket	

DAS.4/.../GR	Cat. No.	DS...GR
DAS.4/...	Cat. No.	DS...
2 levels with varistor		
4		
0.2-6		
0.2-6		
4-WP40/16		
630 V (*) / - / A4		
-		
8 KV / 3		
9		
0.5 / 1.2		
62 / 64 / 6		
70 / 64 / 6		
66 / 64 / 6		

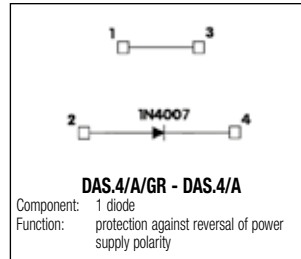

Code DS111GR - DS111

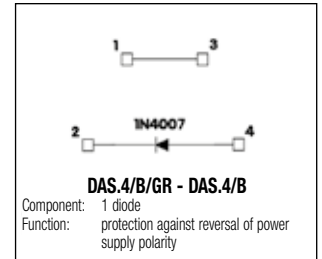

Code DS112GR - DS112

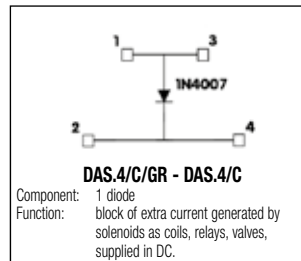

Code DS113GR - DS113

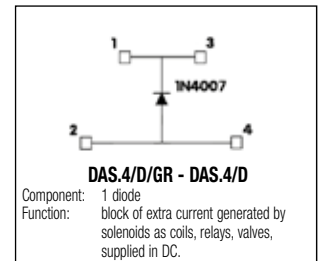

Code DS114GR - DS114



Code DS115GR - DS115

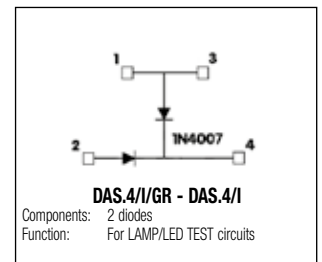

Code DS119GR - DS119

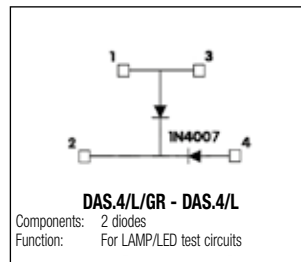

Code DS130GR - DS130

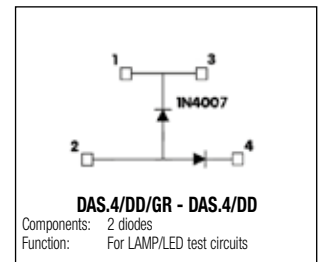

Code DS120GR - DS120

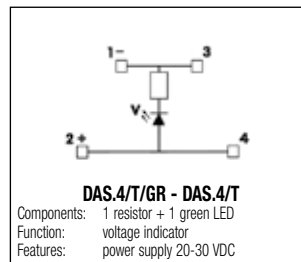

Code DS128GR - DS128

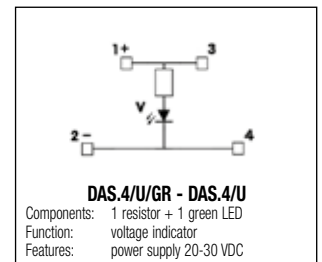

Code DS129GR - DS129

(*) The voltage and current ratings given for the various versions are based on the various type of components and to their connections.

With special connections

- with flat push-on tab connections
- universal mounting for both PR/DIN and PR/3 rails which meet IEC 60715 norms, "G32" and TH/35 types
- available in beige
- maximum operating temperature 100°C



6.3 x 0.8 mm flat push-on tab connections compliant with the IEC 60760 Standard



6.3 x 0.8 mm flat push-on tab connections compliant with the IEC 60760 Standard



with 1.6 x 0.8 mm lug for wrapped wire connections

AF0.2/2+2/TPM Code AF420
with 2.4 x 0.8 mm lug for connections to clamp or to twisted wire

beige version	AF0.2/1+1 Cat. No. AF500	AF0.2/2+2 Cat. No. AF400	AF0.2/2+2/TPM Cat. No. AF410
TECHNICAL CHARACTERISTICS			
function/type	feed-through with push-on tab connections - separate levels	feed-through with push-on tab connections	feed-through with push-on tab connections and lug
rated cross-section (mm ²)	2.5	2.5	2.5
connecting capacity			
flexible (mm ²)	up to 2.5	up to 2.5	up to 2.5
rigid (mm ²)	-	-	-
rated voltage / rated current / gauge conf. to IEC 60947-7-1	400 V / 20 A / -	630 V / 20 A / -	320 V / 10 A / -
rated voltage / rated current / AWG / tightening torque value UL (Ex e) rated voltage (V)	300 V / 15 A / -	600 V / 15 A / -	-
rated impulse withstand voltage / pollution degree	4 kV / 3	6 kV / 3	4 kV / 3
insulation stripping length (mm)	-	-	-
tightening torque value (test / max) (Nm)	-	-	-
height / width / thickness TH/35 7.5 mm	49 / 44 / 6.5	49 / 44 / 6.5	49 / 59 / 6.5
height / width / thickness TH/35 15 mm	57 / 44 / 6.5	57 / 44 / 6.5	57 / 59 / 6.5
height / width / thickness G32	52 / 44 / 6.5	52 / 44 / 6.5	52 / 59 / 6.5
APPROVALS			
ACCESSORIES			
End sections	grey beige blue		
Permanent cross connection	-	-	-
Switchable cross connection	-	-	-
Multiple common bar	250 mm	-	-
Shunting screw and sleeve	-	-	-
Coloured partition	red, green, white		
Cross connection barrier	red		
Test plug socket	-	-	-
Test plug	-	-	-
Numbering strip	-	-	-
Cover for cross-connection	-	-	-
Warning plate	-	-	-
Marking tag	printed or blank		
End bracket			
	Type Cat. No.	Type Cat. No.	Type Cat. No.
	AFO/PT AF201	AFO/PT AF201	AFO/PT AF201
	-	-	-
	DFU/1 DU01..	DFU/1 DU01..	DFU/1 DU01..
	-	-	-
	CNU/8/51 NU0851	CNU/8/51 NU0851	CNU/8/51 NU0851
	BTU for PR/DIN and PR/3 BT005	BTU for PR/DIN and PR/3 BT005	BTU for PR/DIN and PR/3 BT005
	BT/DIN/PO for PR/DIN only BT001	BT/DIN/PO for PR/DIN only BT001	BT/DIN/PO for PR/DIN only BT001
	BT/3-BTO for PR/3 only BT003-BT007	BT/3-BTO for PR/3 only BT003-BT007	BT/3-BTO for PR/3 only BT003-BT007

With special connections

- with flat push-on tab connections
- universal mounting for both PR/DIN and PR/3 rails which meet IEC 60715 norms, "G32" and TH/35 types
- available in beige and grey, where indicated
- maximum operating temperature 100°C



6.3 x 0.8 mm, or 2.8 x 0.8 mm, flat push-on tab connections compliant with the IEC 60760 Standard

Cross-connection possibility

6.3 x 0.8 mm, or 2.8 x 0.8 mm, flat push-on tab connections, compliant with the IEC 60760 Standard

The **/GR** tag indicates the grey version.

grey version
beige version
(Ex)i version

TECHNICAL CHARACTERISTICS

function/type	
rated cross-section	(mm ²)
connecting capacity	
flexible	(mm ²)
rigid	(mm ²)
max. flexible with ferrule (mm ²) - ferrule type	
rated voltage / rated current / gauge	conf. to IEC 60947-7-1
rated voltage / rated current / AWG / tightening torque value	UL
(Ex e) rated voltage	(V)
rated impulse withstand voltage / pollution degree	
insulation stripping length	(mm)
tightening torque value (test / max)	(Nm)
height / width / thickness	TH/35 7.5 mm
height / width / thickness	TH/35 15 mm
height / width / thickness	G32

PDF.2/GR	Cat. No. PF100GR
PDF.2	Cat. No. PF100



feed-through for push-on tab connections	2.5
up to 2.5	-
630 V / 20 A / -	600 V / 16 A / 20-10 AWG
6 kV / 3	-
insulation stripping length	-
tightening torque value (test / max)	-
height / width / thickness	50 / 57 / 6.5
height / width / thickness	58 / 57 / 6.5
height / width / thickness	54 / 57 / 6.5

FDP.2/GR	Cat. No. FD100GR
FDP.2	Cat. No. FD100



feed-through for push-on tab connections	2.5
up to 2.5	-
800 V / 20 A / -	600 V / 16 A / 20-10 AWG
8 kV / 3	-
insulation stripping length	-
tightening torque value (test / max)	-
height / width / thickness	49 / 65.5 / 6.5
height / width / thickness	57 / 65.5 / 6.5
height / width / thickness	53 / 65.5 / 6.5

CVF.4/GR	Cat. No. CV100 GR
CVF.4	Cat. No. CV100
CVF.4 (Ex)i	Cat. No. CV200



feed-through 1 screw and 3-push-on connections	4
up to 2.5	-
800 V / 20 A / A4	600 V / 20 A / 20-12 AWG / 4.4 lb.in
8 kV / 3	-
insulation stripping length	11
tightening torque value (test / max)	-
height / width / thickness	52 / 48.5 / 6
height / width / thickness	60 / 48.5 / 6
height / width / thickness	56 / 48.5 / 6

APPROVALS



ACCESSORIES

End section	grey beige blue
Permanent cross connection (pre-assembled)	-
Switchable cross connection	-
Multiple common bar	250 mm
Shunting screw and sleeve	-
Coloured partition	red, green, white
Cross connection barrier	red
Test plug socket	-
Test plug	-
Numbering strip	-
Cover for connections	-
Warning plate	-
Marking tag	numbered or neutral
End bracket	-

Type	Cat. No.
PDF/PT/GR	PF101GR
PDF/PT	PF101
-	-
DFU/5	DU05..
-	-
CNU/8/51	NU0851
BTU for PR/DIN and PR/3	BT005
BT/DIN/PO only for PR/DIN	BT001
BT/3-BTO only for PR/3	BT003-BT007

Type	Cat. No.
FDP/PT/GR	FD101GR
FDP/PT	FD101
PH/2.5-4	PH100
-	-
DFU/5	DU05..
-	-
SDD/1	DD001
-	-
CNU/8/51	NU0851
BTU for PR/DIN and PR/3	BT005
BT/DIN/PO only for PR/DIN	BT001
BT/3-BTO only for PR/3	BT003-BT007

Type	Cat. No.
CVF/PT/GR	CV101GR
CVF/PT	CV101
CVF/PT (Ex)i	CV201
PM/40/2 poles	PM402
PM/584/42 poles	PM584
-	-
PMP/58	PMP58
CPM/12	CPM12
DFU/3	DU03..
-	-
PSD/A	PD001
SDD/1	DD001
CNU/8/61	NU0861
-	-
CNU/8/51	NU0851
BTU for PR/DIN and PR/3	BT005
BT/DIN/PO only for PR/DIN	BT001
BT/3-BTO only for PR/3	BT003-BT007

For thermocouples

- for thermocouple circuits
- universal mounting for both PR/DIN and PR/3 rails which meet IEC 60715 norms, "G32" and TH/35 types
- Certificate **CESI 02 ATEX 134 U** EX e I M2 / II 2 G D operating temperature range: -40 – +80 °C
- maximum operating temperature 100°C



standard version		TC/PO Cat. No. TC500
grey version		TC/PO/GR Cat. No. TC500GR
(Ex)i version		TC/PO (Ex)i Cat. No. TC510
TECHNICAL CHARACTERISTICS		
function/type		for thermocouple circuits
rated cross-section	(mm ²)	-
connecting capacity		
flexible	(mm ²)	-
rigid	(mm ²)	Ø 0.8–1.3 mm thermocouples
rated voltage / rated current / gauge	conf. to IEC 60947-7-1	800 V / - / -
rated voltage / rated current / AWG / tightening torque value	UL	600 V / 15 A / 20-14 AWG / 5.5 lb.in.
(Ex e) rated voltage	(V)	400 V / 630 V / <1A
rated impulse withstand voltage / pollution degree		8 KV / 3
insulation stripping length	(mm)	20
tightening torque value (test / max)	(Nm)	0.4 / 0.8
height / width / thickness	TH/35 7.5 mm	47 / 40.5 / 5.5
height / width / thickness	TH/35 15 mm	55 / 40.5 / 5.5
height / width / thickness	G32	51 / 40.5 / 5.5
APPROVALS		
ACCESSORIES		Type Cat. No.
End sections	beige grey blue	CB2/PT CB111 CB2/PT/GR CB111GR CB2/PT (Ex)i CBX13
Permanent cross connection		-
Switchable cross connection		-
Multiple common bar	250 mm	-
Shunting screw and sleeve		-
Coloured partition	red, green, white	DFU/1 DU01..
Cross connection barrier	red	-
Test plug socket		-
Test plug		-
Numbering strip		-
Cover for cross-connection		-
Warning plate		-
Marking tag	printed or blank	CNU/8/51 NU0851
End bracket		BTU for PR/DIN and PR/3 BT005 BT/DIN/PO for PR/DIN only BT001 BT/3-BTO for PR/3 only BT003-BT007



terminal block suitable for connecting any type of conductor for thermocouple circuits. In fact it is possible, thanks to the excellent electrical contact that results from it, **to clamp thermocouples of any type without interposing any compensation material.** Besides the management of a single article, this solution permits the reduction of the contact points in the overall circuit.

The range of diameters of the conductors connectable, to make the connection in question fully effective and permanent, must be between 0.8 and 1.3 mm.

The thermocouple circuits, also of a different diameter, stripped of the insulating sleeve for a length of 20 mm, must be placed one on top of another in the terminal block so as to enable the direct passage of thermoelectric E.M.F. without going through a metal body, as happens in normal circuits.

With the double clamping, ensured by two screws and by the interposition of the pressure plate, the possibility of EMFs determined by the non-uniformity of the contacts is reduced almost to zero.

With special connections

- for female connectors pitch 5.08 mm
- double possible insertion of the “Easy Bridge” multi-polar connection - PTC cross connection
- universal mounting for both PR/DIN and PR/3 rails which meet IEC 60715 norms, “G32” and TH/35 types
- available in grey
- maximum operating temperature 100°C



For the isolation figures with cross connections refer to the table on page 131

Detail with PTC jumpers and barriers



Detail with 5.08 mm female connectors and lug protection covers in up position



(*) current on the shank

The /GR tag indicates the grey version.

grey version	
(Ex)i version	
TECHNICAL CHARACTERISTICS	
function/type	
rated cross-section	(mm ²)
connecting capacity	
flexible	(mm ²)
rigid	(mm ²)
max. flexible with ferrule (mm ²) - ferrule type	
rated voltage / rated current / gauge	conf. to IEC 60947-7-1
rated voltage / rated current / AWG / tightening torque value	UL
(Ex e) rated voltage	(V)
rated impulse withstand voltage / pollution degree	
insulation stripping length	(mm)
tightening torque value (test / max)	(Nm)
height / width / thickness	TH/35 7.5 mm
height / width / thickness	TH/35 15 mm
height / width / thickness	G32

VPC.2/GR	Cat. No. VP300GR
VPC.2 (Ex)i	Cat. No. VP310

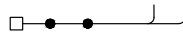

1 screw connection and 2 pins or female connectors	2.5
flexible	0.2-4
rigid	0.2-4
max. flexible with ferrule (mm ²) - ferrule type	2.5-WP25/14
rated voltage / rated current / gauge	320 V / 24-12 (*) A / A3
rated voltage / rated current / AWG / tightening torque value	600 V / 20-14 AWG / 15 A / 5.5 lb.in.
(Ex e) rated voltage	-
rated impulse withstand voltage / pollution degree	4 kV / 3
insulation stripping length	9 (screw connection)
tightening torque value (test / max)	0.4 / 0.8 (screw connection)
height / width / thickness	51 / 44 / 5.08
height / width / thickness	59 / 44 / 5.08
height / width / thickness	55 / 44 / 5.08

5.08 mm pitch female connectors are available – 90°, with number of poles from 2 up to 16. The connector is easily inserted pressing it up to the stop position, guaranteeing optimal connection on the male contact. In this position the connector is hooked onto the insulating body with the holding tooth with which it is fitted.

VPC/F02 - 2 poles	Code VP902
VPC/F03 - 3 poles	Code VP903
VPC/F04 - 4 poles	Code VP904
VPC/F05 - 5 poles	Code VP905
VPC/F06 - 6 poles	Code VP906
VPC/F07 - 7 poles	Code VP907
VPC/F08 - 8 poles	Code VP908
VPC/F09 - 9 poles	Code VP909
VPC/F10 - 10 poles	Code VP910
VPC/F11 - 11 poles	Code VP911
VPC/F12 - 12 poles	Code VP912
VPC/F13 - 13 poles	Code VP913
VPC/F14 - 14 poles	Code VP914
VPC/F15 - 15 poles	Code VP915
VPC/F16 - 16 poles	Code VP916

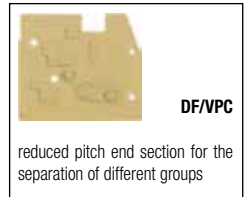
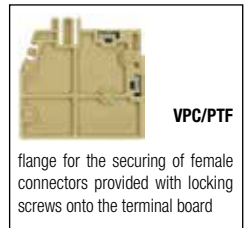

APPROVALS



ACCESSORIES

End sections	grey blue
Permanent cross connection (intrinsically IPXXB protected once mounted)	
Cross-connection identification strip (100 mm)	green
Switchable cross connection	
Jumper barrier	
Shunting screw and sleeve	
Coloured partition	red, green, white
Perforated barrier	grey beige
Test plug socket	
Test plug	
Numbering strip	
Cover for cable lugs	
Flange	
Marking tag	printed or blank
End bracket	

Type	Cat. No.
VPC/PT/GR	VP101GR
VPC/PT	VP101
VPC/PT (Ex)i	VP201
PTC/2/02 poles	PTC0202
PTC/2/03 poles	PTC0203
PTC/2/05 poles	PTC0205
PTC/2/10 poles	PTC0210
PTC/2/00 (50 poles)	PTC0200
PTC/SP	PTC0990
-	
DFM/300	DF300
-	
DFU/5	DU05
DF/VPC/GR	DU02SGR
DF/VPC	DU02S
-	
VPC/VT	VP102
VPC/PTF	VP303
CNU/8/51	NU0851
BTU for PR/DIN and PR/3	BT005
BT/DIN/PO for PR/DIN only	BT001
BT/3-BTO for PR/3 only	BT003-BT007

For even more secure fixing of the connector it is possible to use connectors specifically fitted with locking screws on the side. In this case it is necessary to place a **VPC/PTF** (code VP303) flange alongside, to the right and left of the block of VPC.2 terminal blocks. If the set thus made up proposes a flange with external connection stalks it is necessary to add a **VPC/PT** terminal plate, or to eliminate the stalks themselves using a cutter. For reasons of safety the connectors must be handled only in the absence of load.

Use of the barrier **DF/VPC** (code DU02S), for physical and/or visual separation of blocks of terminal blocks, does not affect the possibility of creating parallel cross connections.

The terminal block can be supplied also in the version with a warning light (VPC/L024). In this case a collector bar (dimensions 7 x 1 x 250 mm), for the common return of a LED (red – 24V), must be inserted in the specific seat on the side of the insulating body of the group of terminal blocks side-by-side and connected via a power supply terminal block **VPC.2 (Ex)i/D** (code VP400). The power supply terminal block VPC.2 (Ex)i/D is a variant of the VPC.2(Ex)i terminal block equipped with a diode 1N4007.

A transparent cover to protect the male shanks from accidental contacts is supplied as an accessory (**VPC/VT** code VP102) in a 10-pole stick, easily dividable to obtain the number of poles necessary. It snaps into the special seat provided on the insulating bar; the insertion point works as a fulcrum for the rotation of the protection from the closed position (position which is guaranteed by a stopper) to open (for inserting the connector). It is made of transparent material to ensure a view of both the connection type (closed pos.) and the LED, in open position and with the connector inserted.

With special connections

- for female connectors pitch 5.08 mm – on 2 levels
- universal mounting onto PR/3 profiles conforming to IEC 60715 standards, TH/35 type
- double possible insertion of the “Easy Bridge” multipolar connection system - PTC cross connection, on each of the two levels
- available in grey
- maximum operating temperature 100°C



For the isolation figures with cross connections refer to the table on page 131

Detail with 5.08 mm female connectors inserted on the two levels, the lug protection covers raised and the PTCs inserted on the two levels.

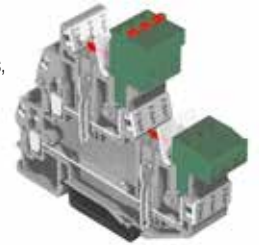

(*) current on the shank

The /GR tag indicates the grey version.

grey version	
(Ex)i version	
TECHNICAL CHARACTERISTICS	
function/type	
rated cross-section	(mm ²)
connecting capacity	
flexible	(mm ²)
rigid	(mm ²)
max. flexible with ferrule (mm ²) - ferrule type	
rated voltage / rated current / gauge	conf. to IEC 60947-7-1
rated voltage / rated current / AWG / tightening torque value	UL
(Ex e) rated voltage	(V)
rated impulse withstand voltage / pollution degree	
insulation stripping length	(mm)
tightening torque value (test / max)	(Nm)
height / width / thickness	TH/35 7.5 mm
height / width / thickness	TH/35 15 mm
height / width / thickness	G32

VPD.2/GR	
Cat. No.	VP500GR
VPD.2 (Ex)i	
Cat. No.	VP560

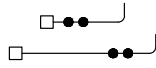

2 level feed-through with 2 screw connections and 2 pins for connectors	2.5
	0.2-4
	0.2-4
	-
	320 V / 24-12 (*) A / A3
	300 V / 15 A / 26-12 AWG / 3.5 lb.in.
	-
	4 kV / 3
	9
	0.4 / 0.8 (screw connection)
	64 / 74 / 5.08
	72 / 74 / 5.08
	- / - / -

5.08 mm pitch - 90° female connectors are available, with from 2 up to 16 poles. The connector is easily inserted pressing it up to the stop position, guaranteeing optimal connection on the male contact. In this position the connector is hooked onto the insulating body with the holding tooth, with which it is fitted.

VPC/F02 - 2 poles	Code	VP902
VPC/F03 - 3 poles	Code	VP903
VPC/F04 - 4 poles	Code	VP904
VPC/F05 - 5 poles	Code	VP905
VPC/F06 - 6 poles	Code	VP906
VPC/F07 - 7 poles	Code	VP907
VPC/F08 - 8 poles	Code	VP908
VPC/F09 - 9 poles	Code	VP909
VPC/F10 - 10 poles	Code	VP910
VPC/F11 - 11 poles	Code	VP911
VPC/F12 - 12 poles	Code	VP912
VPC/F13 - 13 poles	Code	VP913
VPC/F14 - 14 poles	Code	VP914
VPC/F15 - 15 poles	Code	VP915
VPC/F16 - 16 poles	Code	VP916

APPROVALS



ACCESSORIES

End sections	grey beige blue
Permanent cross connection (intrinsically IPXXB protected once mounted)	
Cross-connection identification strip (100 mm)	green
Switchable cross connection	
Multiple common bar	250 mm
Shunting screw and sleeve	
Coloured partition	red, green, white
Jumper barrier	
Test plug socket	
Test plug	
Numbering strip	
Cover for cable lugs	
Flange	
Marking tag	printed or blank
End bracket	

Type	Cat. No.
VPD/PT/GR	VP501GR
VPD/PT	VP501
VPD/PT (Ex)i	VP561
PTC/2/02 poles	PTC0202
PTC/2/03 poles	PTC0203
PTC/2/05 poles	PTC0205
PTC/2/10 poles	PTC0210
PTC/2/00 (50 poles)	PTC0200
PTC/SP	PTC0990
-	
DFU/7	DU07
DFM/300	DF300
-	
VPD/VT	VP502
-	
GNU/8/51	NU0851
BTU for PR/DIN and PR/3	BT005
BT/DIN/PO for PR/DIN only	BT001
BT/3-BTO for PR/3 only	BT003-BT007

MAC Series

- for CAM type modular connectors
- mounting on PR/DIN and PR/3 rails which meet the IEC 60715 standard, "G32" and TH/35 types
- available in: beige
- available on request
- maximum operating temperature 100°C



Version available with 2.8 x 0.8 mm solder lug:
MAC.6/VS Cat. No. MA500



Our F5 type Ø 5 x 20 mm - 250 V fuse (supplied separately) **without** pilot LED



Version without disconnect lever suitable for the permanent use with CAM connector

(*) Values referred to the characteristics of the insulating body

beige version	MAC.6 Cat. No. MA100	MAC.6/FS Cat. No. MA410	MAC.6/N Cat. No. MA200
TECHNICAL CHARACTERISTICS			
function/type	disconnect lever	for Ø 5 x 20 mm fuse	without disconnect lever for use with CAM connector
rated cross-section (mm²)	6	6	6
connecting capacity			
flexible (mm²)	0.2-10	0.2-10	0.2-10
rigid (mm²)	0.2-10	0.2-10	0.2-10
max. flexible with ferrule (mm²) - ferrule type	6-WP60/20	6-WP60/20	6-WP60/20
rated voltage / rated current / gauge conf. to IEC 60947-7-1	800 V (*) / 16 A / A5	800 V (*) / 6.3 A / A5	800 V (*) / 16 A / A5
rated voltage / rated current / AWG / tightening torque value UL (Ex e) rated voltage (V)	600 V (*) / 16 A / 20-10 AWG / 13.3 lb.in	600 V / 8 A / 20-10 AWG / 13.3 lb.in	600 V (*) / 16 A / 20-10 AWG / 13.3 lb.in
rated impulse withstand voltage / pollution degree	8 KV / 3	8 KV / 3	8 KV / 3
insulation stripping length (mm)	14	14	14
tightening torque value (test / max) (Nm)	1.2 / 1.9	1.2 / 1.9	1.2 / 1.9
height / width / thickness TH/35 7.5 mm	65 / 83 / 8	72 / 83 / 8	63 / 77 / 8
height / width / thickness TH/35 15 mm	73 / 83 / 8	80 / 83 / 8	71 / 77 / 8
height / width / thickness G32	69 / 83 / 8	76 / 83 / 8	67 / 77 / 8
APPROVALS			
ACCESSORIES			
End sections	grey beige blue	-	-
Permanent cross connection (pre-assembled)	PIL/2 poles PIL02 PIL/3 poles PIL03 PIL/4 poles PIL04 PIL/8 poles PIL08	PIL/2 poles PIL02 PIL/3 poles PIL03 PIL/4 poles PIL04 PIL/8 poles PIL08	PIL/2 poles PIL02 PIL/3 poles PIL03 PIL/4 poles PIL04 PIL/8 poles PIL08
Switchable cross connection	-	-	-
Multiple common bar	250 mm	-	-
Shunting screw and sleeve	-	-	-
Coloured partition	red, green, white	-	-
Test plug socket	-	-	-
Test plug	SDD/1 DD001	-	SDD/1 DD001
Pitching strip	MAC/SPS MA020	MAC/SPS MA020	MAC/SPS MA020
Ø 5 x 20 mm fuse	-	F5 FN...	-
Marking tag	printed or blank	CNU/8/51 NU0851	CNU/8/51 NU0851
End bracket	BTU for PR/DIN and PR/3 BT005 BT/3-BT0 for PR/3 only BT003-BT007 BT/DIN/PO for PR/DIN only BT001	BTU for PR/DIN and PR/3 BT005 BT/3-BT0 for PR/3 only BT003-BT007 BT/DIN/PO for PR/DIN only BT001	BTU for PR/DIN and PR/3 BT005 BT/3-BT0 for PR/3 only BT003-BT007 BT/DIN/PO for PR/DIN only BT001

Mini terminal blocks

- mounted onto PR/2 rails, TH/15 type
- available in the standard version (grey) or in a version appropriate for use with "intrinsically safe" (Ex)i circuits (blue).
- **RP.4 and RN.2 terminal block:** certificate **CESI 03 ATEX 073 U Ex e** I M2 / II 2 G D temperature range of use: -40 – +80 °C
- **Coc IEC Ex CES 11.0009U Ex e II**
- maximum operating temperature 100°C



The **/GR** tag indicates the grey version.

standard version	RN.1/GR Cat. No. RN300GR	RN.2/GR Cat. No. RN500GR	RP.4/GR Cat. No. RP300GR			
(Ex)i version	RN.1 (Ex)i Cat. No. RN400	RN.2 (Ex)i Cat. No. RN510	RP.4 (Ex)i Cat. No. RP400			
TECHNICAL CHARACTERISTICS						
function/type	feed-through	feed-through	feed-through			
rated cross-section (mm ²)	1.5	2.5	4			
connecting capacity						
flexible (mm ²)	0.2–2.5	0.2–4	0.2–6			
rigid (mm ²)	0.2–2.5	0.2–4	0.2–6			
max. flexible with ferrule (mm ²) - ferrule type	1.5–WP15/14	2.5–WP25/14	4–WP40/16			
rated voltage / rated current / gauge conf. to IEC 60947-7-1	500 V / 17.5 A / A1	400 V / 24 A / A3	630 V / 32 A / A4			
rated voltage / rated current / AWG / tightening torque value UL (Ex e) rated voltage / (V)	600 V / 15 A / 26-14 AWG / 4.5 lb.in	300 V / 20 A / 20–12 AWG / 3.5 lb.in	600 V / 30 A / 20-10 AWG / 4.4 lb.in			
rated impulse withstand voltage / pollution degree	-	320 V / 24 A	320 V / 32 A			
insulation stripping length (mm)	6 kV / 3	6 kV / 3	6 kV / 3			
tightening torque value (test / max) (Nm)	8	8	9			
Height / width / thickness	0.4 / 0.8	0.4 / 0.8	0.5 / 1.2			
	32 / 27 / 4.2	32 / 27 / 5	35 / 31 / 6			
APPROVALS						
ACCESSORIES	Type	Cat. No.	Type	Cat. No.	Type	Cat. No.
End sections	RFN/PT/GR	RF101GR	RFN/PT/GR	RF101GR	RP4/PT/GR	RP301GR
Permanent cross connection	RFN/PT (Ex)i	RF201	RFN/PT (Ex)i	RF201	RP4/PT (Ex)i	RP401
	PM/11/2 poles	PM112	PM/12/2 poles	PM122	PM/41/2 poles	PM412
	PM/11/3 poles	PM113	PM/12/3 poles	PM123	PM/51/3 poles	PM513
	PM/11/5 poles	PM115	PM/12/5 poles	PM125	PM/51/5 poles	PM515
	PM/11/10 poles	PM110	PM/12/10 poles	PM120	PM/51/10 poles	PM510
Switchable cross connection	-	-	-	-	-	-
Multiple common bar	PMP/16	PMP16	PMP/25	PMP25	PMP/58	PMP58
Shunting screw and sleeve (same, Ex e version)	CPM/16	CPM16	CPM/16 (CPX/16)	CPM16 (CPX16)	CPM/01 (CPX/01)	CPM01 (CPX01)
Coloured partition	DFF/2	DFF2..	DFF/2	DFF2..	DFF/2	DFF2..
Test plug socket	PSD/K	PD011	PSD/A	PD001	PSD/A	PD001
Test plug	SDD/1	DD001	SDD/1	DD001	SDD/1	DD001
Numbering strip	SNZ/4	SNO08	CNU/8/51	NU0851	CNU/8/61	NU0861
Warning plate	TQM/02	TQM02	-	-	-	-
Cover for cross-connection	PRP/5	PRP05	PRP/5	PRP05	PRP/5	PRP05
Marking tag	-	-	CNU/8/51	NU0851	CNU/8/51	NU0851
End bracket	BT/2	BT006	BT/2	BT006	BT/2	BT006
	-	-	-	-	-	-
	-	-	-	-	-	-

Mini terminal blocks

- mounted onto PR/2 rails, TH/15 type
- **TR.2 and TR.4 terminal block:**
certificate **CESI 03 ATEX 022 U Ex e**
I M2 / II 2 G D temperature range of use:
-40 – +80 °C
- available in grey
- **Coc IEC Ex CES 11.0004U Ex e II**
- maximum operating temperature 100°C



Two 6.3 x 0.8 mm or four 2.8 x 0.8 mm
flat push-on tab connections
compliant with IEC 60760

The **/GR** tag indicates the grey version.

standard version	RFI.2/GR Cat. No. RF110GR	TR.2 Cat. No. TR110	TR.4 Cat. No. TR200
TECHNICAL CHARACTERISTICS			
function/type	feed-through for push-on tab connections	earth	earth
rated cross-section (mm ²)	2.5	2.5	4
connecting capacity			
flexible (mm ²)	up to 2.5	0.2–4	0.2–6
rigid (mm ²)	-	0.2–4	0.2–6
max. flexible with ferrule (mm ²) - ferrule type	-	2.5–WP25/14	4–WP40/16
rated voltage / rated current / gauge conf. to IEC 60947-7-1	400 V / 20 A / -	- / - / A3	- / - / A4
rated voltage / rated current / AWG / tightening torque value UL (Ex e) rated voltage / (V)	600 V / 20 A / 12 AWG max	- / - / 20-12 AWG / 3.5 lb.in	- / - / 20-10 AWG / 5.5 lb.in
rated impulse withstand voltage / pollution degree	6 kV / 3	6 kV / 3	6 kV / 3
insulation stripping length (mm)	-	8	9
tightening torque value (test / max) (Nm)	- / -	0.4 / 0.8	0.5 / 1.2
Height / width / thickness	32 / 28 / 6	32 / 27 / 5	35 / 35 / 7.3
APPROVALS		 	
ACCESSORIES	Type Cat. No.	Type Cat. No.	Type Cat. No.
End sections grey/blue	RFN/PT/GR RF101GR	TR.2/PT TR111	-
Permanent cross connection	POF/17 POF17	-	-
Switchable cross connection	-	-	-
Multiple common bar 250 mm	PMP/17 PMP17	-	-
Shunting screw and sleeve	CPM/17 CPM17	-	-
Coloured partition red, green, white	DFP/2 DFP2..	DFP/2 DFP2..	DFP/2 DFP2..
Test plug socket	PSD/K PD011	-	-
Test plug	SDD/1 DD001	-	-
Numbering strip	CNU/8/51 NU0851	CNU/8/51 NU0851	-
Warning plate on adjacent terminal blocks	-	-	-
Marking tag printed or blank	CNU/8/61 NU0861	CNU/8/51 NU0851	CNU/8/51 NU0851
End bracket	BT/2 BT006	BT/2 BT006	BT/2 BT006

Modular multi-pole terminal blocks

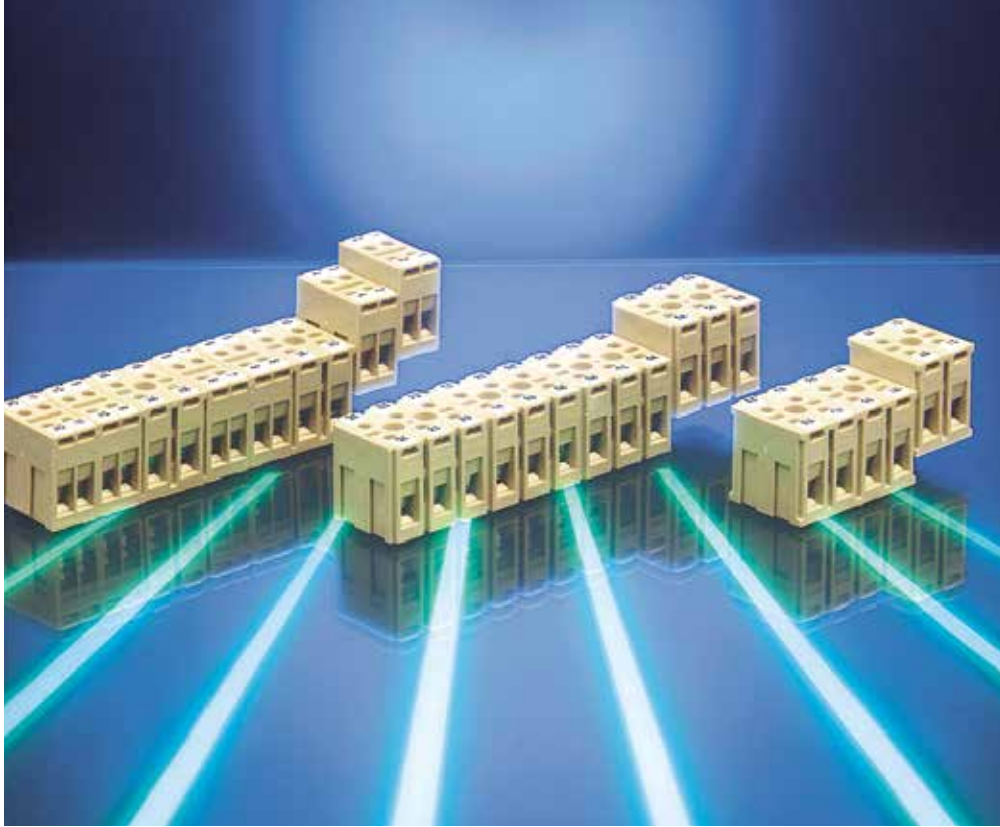

Modular multi-pole terminal blocks

- UL94V-0
- Certificate **CESI 03 ATEX 164 U Ex e** I M2 / II 2 G D temperature range of use: -40 – +80 °C
- to be fixed directly on panel, by means of screws
- **Coc IEC Ex CES 11.0008U Ex e II**
- maximum operating temperature 100°C



The bipolar BPL.4, BPL/R and tripolar TPL.4 terminal boards can be fixed separately or used to lock together terminal boards with an unlimited number of poles without using supporting rails. The special “dovetail” channels, ensuring the maximum compactness of assembly, make sufficient the use of only two screws for fixing, at the end of the terminal board. The BPL.4, BPL/R and TPL.4 terminal boards are made ready for marking with NU0550-type name tags.

standard version	BPL.4 Cat. No. BP100	TPL.4 Cat. No. TP100	BPL/R Cat. No. BP200
TECHNICAL CHARACTERISTICS			
function/type	two-pole	three-pole	two-pole reduced pitch
rated cross-section (mm ²)	4	4	4
connecting capacity			
flexible (mm ²)	0.5–6	0.5–6	0.5–6
rigid (mm ²)	0.5–6	0.5–6	0.5–6
max. flexible with ferrule (mm) - ferrule type	4-WP40/16	4-WP40/16	4-WP40/16
rated voltage / rated current / gauge conf. to IEC 60947-7-1	500 V / 32 A / A4	500 V / 32 A / A4	500 V / 32 A / A4
rated voltage / rated current / AWG / tightening torque value UL	300 V / 20 A / 12–18 AWG / 4.4 lb.in.	300 V / 20 A / 12–18 AWG / 4.4 lb.in.	300 V / 20 A / 12–18 AWG / 4.4 lb.in.
(Ex e) rated voltage / (V)	320 V	320 V	320 V
rated impulse withstand voltage / pollution degree	6 KV / 3	6 KV / 3	6 KV / 3
insulation stripping length (mm)	12	12	12
tightening torque value (test / max) (Nm)	0.5 / 0.7	0.5 / 0.7	0.5 / 0.7
fixing screws (*) (Ø)	M3 (Ø head 5.6 mm max)	M3 (Ø head 5.6 mm max)	-
height/ width/ thickness	26 / 24 / 20	26 / 30 / 20	26 / 24 / 13
APPROVALS	(*)	(*)	(*)

Normal compositions		
Number of poles	BPL.4 and TPL.4 configurations	Total length mm
2	B	20
3	T	30
4	B+B	40
5	B+T	50
6	T+T	60
7	B+T+B	70
8	T+B+T	80
9	T+T+T	90
10	T+B+B+T	100
12	T+T+T+T	120
14	T+T+B+T+T	140
15	T+T+T+T+T	150
16	T+T+B+B+T+T	160
18	T+T+T+T+T+T	180
20	T+T+T+B+T+T+T	200

(*) NOTE: when using BPL.4 and TPL.4 terminal blocks in Ex e classified installations, the use of the insulated fixing screw is required.

Modular multi-pole terminal blocks

- UL94V-0
- to be fixed directly on panel, by means of screws
- /PS versions, with poles holding a screw connection and a flat-plug feed-through shank (2.3 x 0.8 mm) usable also for welding
- maximum operating temperature 100°C



(*): with bearing plate thickness = 1 mm

standard version	BPL.4/PS Cat. No. BP300	TPL.4/PS Cat. No. TP200
TECHNICAL CHARACTERISTICS		
function/type	version with special connections	version with special connections
rated cross-section (mm ²)	4	4
connecting capacity		
flexible (mm ²)	0.5-6	0.5-6
rigid (mm ²)	0.5-6	0.5-6
max. flexible with ferrule (mm) - ferrule type	4-WP40/16	4-WP40/16
rated voltage / rated current / gauge conf. to IEC 60947-7-1	500 V (*) / 32 A / A4	500 V (*) / 32 A / A4
rated voltage / rated current / AWG / tightening torque value UL	300 V / 20 A / 12-18 AWG / 4.4 lb.in.	300 V / 20 A / 12-18 AWG / 4.4 lb.in.
(Ex e) rated voltage (V)	-	-
rated impulse withstand voltage / pollution degree	6 KV / 3	6 KV / 3
insulation stripping length (mm)	12	12
tightening torque value (test / max) (Nm)	0.5 / 0.7	0.5 / 0.7
fixing screws (*) (Ø)	M3 (Ø head 5.6 mm max)	M3 (Ø head 5.6 mm max)
Height / width / thickness TH/15	36 / 24 / 20	36 / 24 / 20
APPROVALS		

Normal compositions		
Number of poles	BPL.4 and TPL.4 configurations	Total length mm
6	B+R+B	53
8	B+R+R+B	66
10	B+R+R+R+B	79
12	B+R+R+R+R+B	92
14	B+R+R+R+R+R+B	105
16	B+R+R+R+R+R+R+B	118
18	B+R+R+R+R+R+R+R+B	131
20	B+R+R+R+R+R+R+R+R+B	144

PS versions, equipped with solder connections are also available in the following configurations:

BPL.4/PS (Cat. No. BP300) - TPL.4/PS (Cat. No. TP200)
equipped with screw connections on the opposite side from the solder connections

BPL.4/PS/A (Cat. No. BP310) - TPL.4/PS/A (Cat. No. TP210)
equipped with screw connections on the same side as the solder connections

CF.12/1+1 multi-pole terminal board

with 6.3 x 0.8 mm flat push-on tab connections (2 for each pole)

- insulating body made of UL94V-0 beige or blue polyamide
- maximum operating temperature 100°C

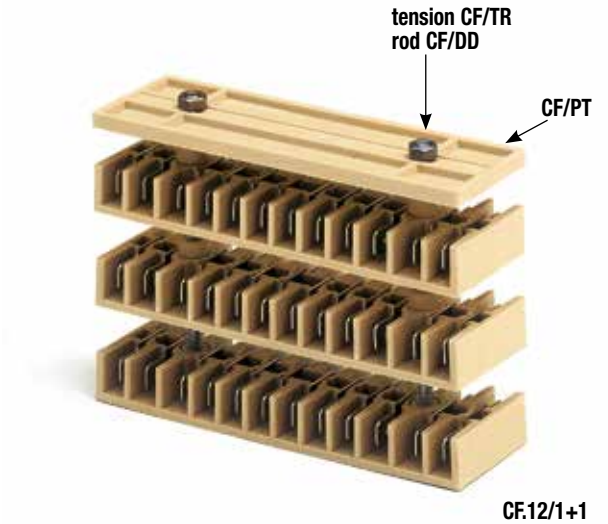

CF.12/1+1 (without end section)	Cat. No.	CF100
CF.12/1+1 (Ex)i	Cat. No.	CFX10
CF.12/CPT (with end section)	Cat. No.	CF900
CF.12/CPT (Ex)i	Cat. No.	CFX90

TECHNICAL CHARACTERISTICS

rated cross-section	2.5 mm ²
rated current (according to IEC 60947-7-1)	20 A
rated voltage (according to IEC 60947-7-1)	500 V
rated impulse withstand voltage / pollution degree	6 KV / 3

ACCESSORIES

Upper end section	of beige polyamide	CF/PT
Upper end section	of blue polyamide	CF/PT (Ex)i
Upper special end section	of polyamide	CF/PTM
Insulating bushing	of beige polyamide	CF/BI
M4 threaded tension rods	of zinc-plated steel	CF/TR
Nut (bolt)	of polyamide	CF/DD

The **CF.12/1+1** terminal boards can be mounted singularly or one on top of another. In both cases the single terminal board or the terminal board located at the top of the group must be closed with the CF/PT end platelet (thickness 4 mm). Fixing to the panel beneath can be done using:

- screws of an adequate length (**spacing between holes 69.5 mm**)
- M4 **threaded tension rods**

To ensure the maximum insulation from earth and correct mounting of the stacked terminal boards it is necessary to insert the special **bushings CF/BI** in the holes on the body of the bases. Bushings between the terminal board and the end platelet are not required because the latter is already opportunely shaped.

The above end platelet bears in relief the numbering from 1 to 12 for easy identification of the poles.

The connection plugs, completely protected from the outside and with opportune barriers between them, are made of a copper-zinc alloy, with a high percentage of copper, galvanic anti-rust and anti-corrosive protection in nickel or, on request, in silver (**CF.12/1+1/AG** Code CFA10).

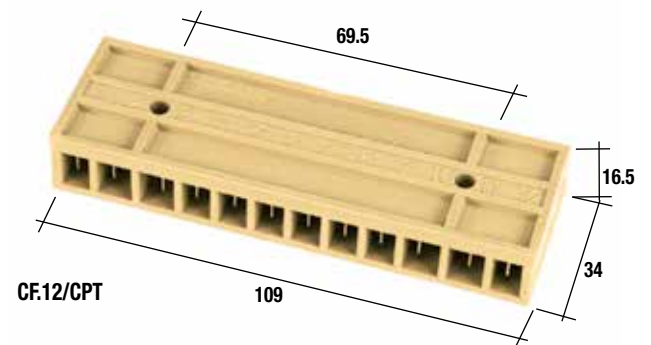

CF/PTM (Code CF301)
Special end section to be mounted in grooving



CF.12/FW/CPT (Code CFW90)
Version equipped with flat push on tab connections on one side and wrapped wire on the other side

CF.12/FW/CPT (Ex)i (Code CFW99)

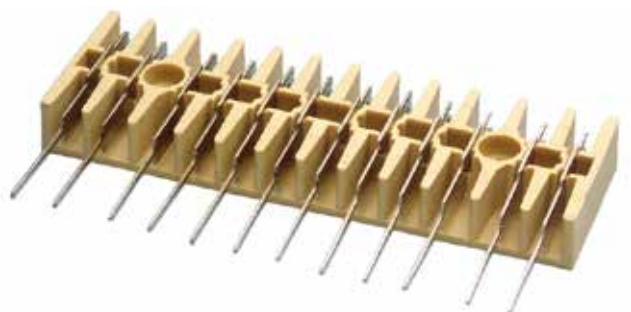

CF.12/2+2 multi-pole terminal board

with 6.3 x 0.8 mm flat push-on tab connections (2 for each pole)

- insulating body made of UL94V-0 beige or blue polyamide
- maximum operating temperature 100°C

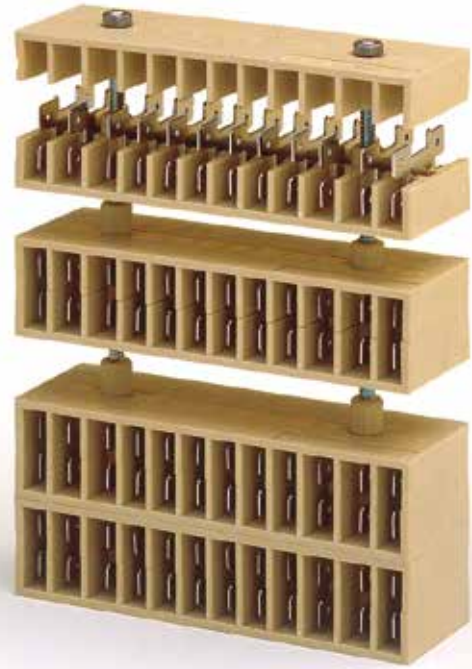

CF.12/2+2

Cat. No.

CF200

TECHNICAL CHARACTERISTICS

rated cross-section	2.5 mm ²
rated current (according to IEC 60947-7-1)	20 A
rated voltage (according to IEC 60947-7-1)	500 V
rated impulse withstand voltage / pollution degree	6 kV / 3

ACCESSORIES

Insulation bushing	made of polyamide CF/BI
Reduced bushing	made of polyamide CF/BR
M4 threaded tension rods	of zinc-plated steel CF/TR
Nut (bolt)	of polyamide CF/DD

The **CF.12/2+2** terminal boards can be mounted singularly or one on top of another. Fixing to the panel beneath can be done using:

- screws of an adequate length (**spacing between holes 69.5 mm**)
- M4 **threaded stay bolts**

To ensure the maximum insulation from earth and correct mounting of the stacked terminal boards it is necessary to insert the special **bushings CF/BI** in the holes on the body of the bases. To enable better clamping of the **CF/DD nuts**, in the case of use of threaded stay bolts, it is opportune to insert in the holes of the upper terminal board the **reduced bushings CF.BR**.

The **CF.12/2+2** terminal boards bear, on both bases, in relief, the numbering from 1 to 12 for easy identification of the poles.

The connection plugs, completely protected from the outside and with opportune barriers between them, are made of a copper-zinc alloy, with a high percentage of copper, galvanic anti-rust and anti-corrosive protection in nickel or, on request, in silver (CF.12/2+2/AG Code CFA20).

Note: a version provided with eight 6.3 x 0.8 mm flat push-on tab connectors is available. **CF.08/2+2** Cat. No. **CF400**

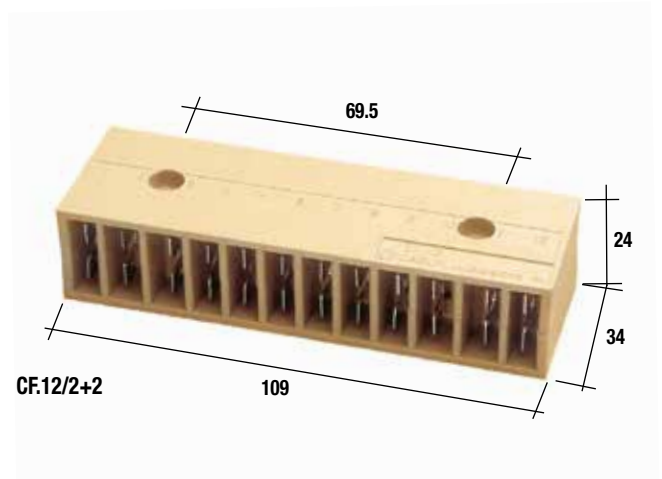

CNT Series

Neutral disconnect terminal blocks

- UL94V-0
- mounting on PR/DIN and PR/3 rails which meet the IEC 60715 standard, "G32" and TH/35 types
- in blue
- maximum operating temperature 100°C



(Ex)i version	CNT.6 Cat. No. CNT06	CNT.16 Cat. No. CNT16	CNT.35 Cat. No. CNT35
TECHNICAL CHARACTERISTICS			
function/type	neutral disconnect terminal block	neutral disconnect terminal block	neutral disconnect terminal block
rated cross-section (mm ²)	6	16	35
connecting capacity			
flexible (mm ²)	0.5–6	0.5–16	0.5–35
rigid (mm ²)	0.5–10	0.5–25	0.5–50
max. flexible with ferrule (mm ²) - ferrule type	6-WP60/20	16-WP160/22	35-WP350/30
rated voltage / rated current / gauge conf. to IEC 60947-7-1	400 V / 41 A / A5	400 V / 76 A / B7	400 V / 125 A / A9
rated voltage / rated current / AWG / tightening torque value UL	-	-	-
(Ex e) rated voltage (V)	-	-	-
rated impulse withstand voltage / pollution degree	6 KV / 3	6 KV / 3	6 KV / 3
insulation stripping length (mm)	10.5	12	14.5
tightening torque value (test / max) (Nm)	1.2 / 1.9	2 / 3	2.5 / 5
height / width / thickness	52 / 51 / 8	56 / 53 / 12	62 / 56 / 16
height / width / thickness	60 / 51 / 8	64 / 53 / 12	70 / 56 / 16
height / width / thickness	56 / 51 / 8	61 / 53 / 12	66 / 56 / 16

APPROVALS

ACCESSORIES		Type	Cat. No.	Type	Cat. No.	Type	Cat. No.
End sections	blue	CNT6/PT	CNT601	CNT16/PT	CNT161	CNT35/PT	CNT351
Collecting busbar support		CNT/SU	CNTSU	CNT/SU	CNTSU	CNT/SU	CNTSU
Coloured partition	red, green, white	DFU/4	DU04..	DFU/4	DU04..	DFU/4	DU04..
Numbering strip		-	-	-	-	-	-
Marking tag	printed or blank	CNU/8/51	NU0851	CNU/8/51	NU0851	CNU/8/51	NU0851
End bracket		BTU for PR/DIN and PR/3	BT005	BTU for PR/DIN and PR/3	BT005	BTU for PR/DIN and PR/3	BT005
		BT/DIN/PO for PR/DIN only	BT001	BT/DIN/PO for PR/DIN only	BT001	BT/DIN/PO for PR/DIN only	BT001
		BT/3 for PR/3 only	BT003	BT/3 for PR/3 only	BT003	BT/3 for PR/3 only	BT003
		BTO	BT007	BTO	BT007	BTO	BT007

Spring clamp and insulation displacement terminal blocks - Polyamide insulated

Feed-through terminal blocks

HMM.1 Series.	page 70
HMM.2 Series.	page 71
HMM.2/1+2/S	page 71
HMM.2/2+2/A	page 72
HMM.2/2+2/S	page 72
HMM.4.	page 73
HMM.6 - HMM.10 - HMM.16	page 74
HMR.16 voltage distribution terminal block.	page 75

Earth Terminal blocks

HTE.1 Series.	page 76
HTE.2 Series.	page 77
HTE.3 Series.	page 78
HTE.6 - HTE.10 - HTE.16	page 79

Two and three level terminal blocks

HMD.1 - HMD.1/CI	page 80
HMD.2N - HMD.2N/CI	page 80
HMD.2	page 80
HMD.1/X (with electronic components).	page 81
HMD.2N/X (with electronic components).	page 81
HMD.2N/DD - HMD.2N/3DC (with diodes)	page 81
HMD.2N/X1	page 82
HLD.2	page 83
HDE.2	page 83
HTTE.2.	page 83

Disconnect terminal blocks

HMS.2	page 84
HSCB.4 (slide link)	page 84
HSCB.6 (slide link for measuring circuits)	page 84

Fuse-holder terminal blocks

HMFA.2 (for blade type fuses)	page 85
HFR.4/M - HFR.4	page 86

Terminal blocks for connectors

HCD.1	page 87
HVPC.2 - CHP.2 - CHP.2D	page 88
HVTE.2 - CHTE.2 - CHTE.2D	page 89

Mini terminal blocks

HPP.2.	page 90
HP.2.	page 90
HPC.2	page 91

Insulation displacement terminal blocks

NCS - NCV	page 93
---------------------	---------

Spring clamp terminal blocks

- exclusively in the new grey colour



For the creation of high harness volumes, for conductors from 0.2 to 25 mm² and reduced current intensity values, CABUR proposes its range of spring-clamp terminal blocks, in constant evolution.

To protect the clamping system, the insulating body includes a stopper which prevents the spring from going beyond the threshold of its elastic field, if is activated by inexperienced hands.

Adequate sizing of the wire introduction chamber, responding to the requirements of the IEC 60947-1 Standard, guarantees insertion of any type of conductor of the nominal size, also butted with a terminal.

The connection that results from this, in relation to the technology adopted, has the maximum reliability and safety thanks to the quality of the materials used and to the particular conformation of the components needed for the purpose, avoiding damage to the strands of the conductors in the presence of unprepared flexible wires.

The wire entry is perpendicular to the installation surface determining a further reduction of times and costs of the wiring operations above all where the spaces are particularly limited.

To connect together several contiguous elements, a practical and safe bridging system is available.

Terminal blocks with rated cross-sections of between 1.5 and 16 mm² have the possibility of being connected together in the most disparate ways thanks to our exclusive "Easy Bridge" rapid connection system (PTC), which combines efficiency, rapidity and flexibility providing at the same time a exceptional economic result; these characteristics together with the resulting **IPXXB intrinsic installation without the aid of further insulation protections** (of wires, terminal blocks and parallel connections), guarantees better connectivity than that offered by the competitors.



CNU/8



SHZ

Marking systems

In our marking system the same multiple numbering strip (**SHZ**) can be inserted on the sides of the terminal block or in the specific seats present in the upper part of the terminal block itself. This means easy identification of each terminal block from every viewing angle within the electrical panel.

The numbering can be done also with the single standard-type **CNU/8** tags.



HMM Series

- UL94V-0
- mounting onto PR/3 type rails according to IEC 60715 standard, TH/35 type
- available in the standard version (grey) or in a version appropriate for use with "intrinsically safe" (Ex)i circuits (blue5).
- maximum operating temperature 100°C
- INERIS 16 ATEX 9002U Ex e and I M2 Ex e I Mb II 2G Ex e IIC Gb certificate of operating temperature: -40 – +80 °C
- CoC IECEx INE 16.0032U



For the isolation figures with cross connections refer to the table on page 131

The /GR tag indicates the grey version.

grey version	
(Ex)i version	
TECHNICAL CHARACTERISTICS	
function/type	
rated cross-section	(mm ²)
connecting capacity	
flexible	(mm ²)
rigid	(mm ²)
max. flexible with ferrule (mm ²) - ferrule type	
rated voltage / rated current / gauge	conf. to IEC 60947-7-1
rated voltage / rated current / AWG	UL
rated impulse withstand voltage / pollution degree	
insulation stripping length	(mm)
height / width / thickness	TH/35 7.5 mm
height / width / thickness	TH/35 15 mm
height / width / thickness	G32

HMM.1/GR	Cat. No. HM400GR
HMM.1 (Ex)i	Cat. No. HI400
feed-through	
rated cross-section	1.5
connecting capacity	
flexible	0.2–2.5
rigid	0.2–2.5
max. flexible with ferrule (mm ²) - ferrule type	1.5–WP15/14
rated voltage / rated current / gauge	500 V / 17.5 A / B2
rated voltage / rated current / AWG	600 V / 15 A / 26-14 AWG
rated impulse withstand voltage / pollution degree	8 KV / 3
insulation stripping length	10
height / width / thickness	43 / 45 / 4.2
height / width / thickness	51 / 45 / 4.2
height / width / thickness	-

HMM.1/1+2/GR	Cat. No. HM410GR
HMM.1/1+2 (Ex)i	Cat. No. HI410
feed-through, 1 input and 2 outputs	
rated cross-section	1.5
connecting capacity	
flexible	0.2–2.5
rigid	0.2–2.5
max. flexible with ferrule (mm ²) - ferrule type	1.5–WP15/14
rated voltage / rated current / gauge	500 V / 17.5 A / B2
rated voltage / rated current / AWG	600 V / 15 A / 26-14 AWG
rated impulse withstand voltage / pollution degree	8 KV / 3
insulation stripping length	10
height / width / thickness	43 / 56 / 4.2
height / width / thickness	51 / 56 / 4.2
height / width / thickness	-

HMM.1/2+2/GR	Cat. No. HM420GR
HMM.1/2+2 (Ex)i	Cat. No. HI420
feed-through, 2 inputs and 2 outputs	
rated cross-section	1.5
connecting capacity	
flexible	0.2–2.5
rigid	0.2–2.5
max. flexible with ferrule (mm ²) - ferrule type	1.5–WP15/14
rated voltage / rated current / gauge	500 V / 17.5 A / B2
rated voltage / rated current / AWG	600 V / 15 A / 26-14 AWG
rated impulse withstand voltage / pollution degree	8 KV / 3
insulation stripping length	10
height / width / thickness	43 / 65 / 4.2
height / width / thickness	51 / 65 / 4.2
height / width / thickness	-

APPROVALS



ACCESSORIES	
End sections	grey blue
Permanent cross connection (intrinsically IPXXB protected once mounted)	
Rated current carrying capacity of jumper	(A)
Cross-connection identification strip (100 mm)	green
Multiple common bar	250 mm
Shunting screw and sleeve	
Coloured partition	red, green, white
Cross connection barrier	red
Test plug socket	
Test plug	
Modular test plug	
End section for modular test plug	
Numbering strip	
Screwdriver for activation of the spring	
Warning plate	on adjacent terminal blocks
Marking tag	printed or blank
End bracket	

Type	Cat. No.
HMT.1/PT/GR	HM401GR
HMT.1/PT (Ex)i	HI401
PTC/1/02 poles	PTC0410
PTC/1/03 poles	PTC0410
PTC/1/05 poles	PTC0410
PTC/1/10 poles	PTC0410
PTC/1/00 (50 poles)	PTC0400
17.5	
PTC/SP	PTC0990
-	
-	
DFH/1	DH01..
DFM/500	DF500
-	
-	
SDH/4-SDH/4P	DH004-DH04P
SH4/PT	DH401
SHZ/1	SH004
CCH/2.5-4	CCH02
-	
SHZ/1	SH004
BTU for PR/DIN and PR/3	BT005
BTO	BT007
BT/3 for PR/3 only	BT003

Type	Cat. No.
HMT.1/1+2/PT/GR	HM411GR
HMT.1/1+2/PT (Ex)i	HI411
PTC/1/02 poles	PTC0410
PTC/1/03 poles	PTC0410
PTC/1/05 poles	PTC0410
PTC/1/10 poles	PTC0410
PTC/1/00 (50 poles)	PTC0400
17.5	
PTC/SP	PTC0990
-	
-	
DFH/2	DH02..
DFM/500	DF500
-	
-	
SDH/4-SDH/4P	DH004-DH04P
SH4/PT	DH401
SHZ/1	SH004
CCH/2.5-4	CCH02
-	
SHZ/1	SH004
BTU for PR/DIN and PR/3	BT005
BTO	BT007
BT/3 for PR/3 only	BT003

Type	Cat. No.
HMT.1/2+2/PT/GR	HM421GR
HMT.1/2+2/PT (Ex)i	HI421
PTC/1/02 poles	PTC0410
PTC/1/03 poles	PTC0410
PTC/1/05 poles	PTC0410
PTC/1/10 poles	PTC0410
PTC/1/00 (50 poles)	PTC0400
17.5	
PTC/SP	PTC0990
-	
-	
DFH/3	DH03..
DFM/500	DF500
-	
-	
SDH/4-SDH/4P	DH004-DH04P
SH4/PT	DH401
SHZ/1	SH004
CCH/2.5-4	CCH02
-	
SHZ/1	SH004
BTU for PR/DIN and PR/3	BT005
BTO	BT007
BT/3 for PR/3 only	BT003

HMM Series

- UL94V-0
- mounting onto PR/3 type rails according to IEC 60715 standard, TH/35 type
- available in the standard version (grey) or in a version appropriate for use with “intrinsically safe” (Ex)i circuits (blue)
- maximum operating temperature 100°C
- INERIS 16 ATEX 9002U Ex e Ex and I M2 Ex e I Mb II 2G Ex e IIC Gb certificate of operating temperature: -40 – +80 °C
- CoC IECEx INE 16.0032U



For the isolation figures with cross connections refer to the table on page 131

The /GR tag indicates the grey version.

grey version	
(Ex)i version	
TECHNICAL CHARACTERISTICS	
function/type	
rated cross-section	(mm ²)
connecting capacity	
flexible	(mm ²)
rigid	(mm ²)
max. flexible with ferrule (mm ²) - ferrule type	
rated voltage / rated current / gauge	conf. to IEC 60947-7-1
rated voltage / rated current / AWG	UL
rated impulse withstand voltage / pollution degree	
insulation stripping length	(mm)
height / width / thickness	TH/35 7.5 mm
height / width / thickness	TH/35 15 mm
height / width / thickness	G32

APPROVALS

ACCESSORIES	
End sections	grey blue
“Easy Bridge” (PTC) cross connection (intrinsically IPXXB protected once mounted)	
Available also in coloured version (PTP)	
Ref. p. 130	
Rated current carrying capacity of jumper	(A)
Cross-connection identification strip (100 mm)	green
Multiple common bar	250 mm
Shunting screw and sleeve	
Coloured partition	red, green, white
Cross connection barrier	red
Test plug socket	
Test plug	
Modular test plug	
End section for modular test plug	
Numbering strip	
Screwdriver for activation of the spring	
Warning plate	on adjacent terminal blocks
Marking tag	printed or blank
End bracket	

HMM.2/GR	
Cat. No. HM500GR	
HMM.2 (Ex)i	
Cat. No. HI500	
feed-through	
rated cross-section	2.5
connecting capacity	
flexible	0.2–4
rigid	0.2–4
max. flexible with ferrule (mm ²) - ferrule type	2.5–WP25/14
rated voltage / rated current / gauge	800 V / 24 A / A3
rated voltage / rated current / AWG	600 V / 20 A / 24-12 AWG
rated impulse withstand voltage / pollution degree	8 KV / 3
insulation stripping length	10
height / width / thickness	41 / 50 / 5.2
height / width / thickness	49 / 50 / 5.2
height / width / thickness	-



HMM.2/1+2/GR	
Cat. No. HM510GR	
HMM.2/1+2 (Ex)i	
Cat. No. HI510	
feed-through, 1 input and 2 outputs	
rated cross-section	2.5
connecting capacity	
flexible	0.2–4
rigid	0.2–4
max. flexible with ferrule (mm ²) - ferrule type	2.5–WP25/14
rated voltage / rated current / gauge	800 V / 24 A / A3
rated voltage / rated current / AWG	600 V / 20 A / 24-12 AWG
rated impulse withstand voltage / pollution degree	8 KV / 3
insulation stripping length	10
height / width / thickness	41 / 66 / 5.2
height / width / thickness	49 / 66 / 5.2
height / width / thickness	-



HMM.2/2+2/GR	
Cat. No. HM520GR	
HMM.2/2+2 (Ex)i	
Cat. No. HI520	
feed-through, 2 inputs and 2 outputs	
rated cross-section	2.5
connecting capacity	
flexible	0.2–4
rigid	0.2–4
max. flexible with ferrule (mm ²) - ferrule type	2.5–WP25/14
rated voltage / rated current / gauge	800 V / 24 A / A3
rated voltage / rated current / AWG	600 V / 20 A / 24-12 AWG
rated impulse withstand voltage / pollution degree	8 KV / 3
insulation stripping length	10
height / width / thickness	41 / 82 / 5.2
height / width / thickness	49 / 82 / 5.2
height / width / thickness	-



Type	Cat. No.
HMT.2/PT/GR	HM501GR
HMT.2/PT (Ex)i	HI501
PTC/03/02 poles	PTC0302
PTC/03/03 poles	PTC0303
PTC/03/05 poles	PTC0305
PTC/03/10 poles	PTC0310
PTC/03/00 (47 poles)	PTC0300
24	
PTC/SP	PTC0990
-	
DFH/1	DH01..
-	
SDD/1	DD001
SDH/5	DH005
SH5/PT	DH501
CNU/8/51	NU0851
CCH/2.5-4	CCH02
-	
CNU/8/51	NU0851
BTU for PR/DIN and PR/3	BT005
BTO	BT007
BT/3 for PR/3 only	BT003

Type	Cat. No.
HMT.2/1+2/PT/GR	HM511GR
HMT.2/1+2/PT (Ex)i	HI511
PTC/03/02 poles	PTC0302
PTC/03/03 poles	PTC0303
PTC/03/05 poles	PTC0305
PTC/03/10 poles	PTC0310
PTC/03/00 (47 poles)	PTC0300
24	
PTC/SP	PTC0990
-	
DFH/2	DH02..
-	
SDD/1	DD001
SDH/5	DH005
SH5/PT	DH501
CNU/8/51	NU0851
CCH/2.5-4	CCH02
-	
CNU/8/51	NU0851
BTU for PR/DIN and PR/3	BT005
BTO	BT007
BT/3 for PR/3 only	BT003

Type	Cat. No.
HMT.2/2+2/PT/GR	HM521GR
HMT.2/2+2/PT (Ex)i	HI521
PTC/03/02 poles	PTC0302
PTC/03/03 poles	PTC0303
PTC/03/05 poles	PTC0305
PTC/03/10 poles	PTC0310
PTC/03/00 (47 poles)	PTC0300
24	
PTC/SP	PTC0990
-	
DFH/3	DH03..
-	
SDD/1	DD001
SDH/5	DH005
SH5/PT	DH501
CNU/8/51	NU0851
CCH/2.5-4	CCH02
-	
CNU/8/51	NU0851
BTU for PR/DIN and PR/3	BT005
BTO	BT007
BT/3 for PR/3 only	BT003

HMM Series

- UL94V-0
- disconnects with lever
- mounting onto PR/3 type rails according to IEC 60715 standard, TH/35 type
- available in the standard version (grey) or in a version appropriate for use with "intrinsically safe" (Ex)i circuits (blue), where indicated
- maximum operating temperature 100°C



The /GR tag indicates the grey version.

grey version	HMM.2/1+2/S/GR Cat. No. HMS20GR	HMM.2/2+2/A/GR Cat. No. HM170GR	HMM.2/2+2/S/GR Cat. No. HMS10GR			
TECHNICAL CHARACTERISTICS						
function/type	disconnect, 1 input and 2 outputs	disconnect (open), 2 inputs and 2 outputs	disconnect, 2 inputs and 2 outputs			
rated cross-section (mm ²)	2.5	2.5	2.5			
connecting capacity						
flexible (mm ²)	0.2-4	0.2-4	0.2-4			
rigid (mm ²)	0.2-4	0.2-4	0.2-4			
max. flexible with ferrule (mm ²) - ferrule type	2.5-WP25/14	2.5-WP25/14	2.5-WP25/14			
rated voltage / rated current / gauge conf. to IEC 60947-7-1	400 V / 16 A / A3	400 V / 16 A / A3	400 V / 16 A / A3			
rated voltage / rated current / AWG	600 V / 20 A / 24-12 AWG	600 V / 20 A / 24-12 AWG	600 V / 20 A / 24-12 AWG			
rated impulse withstand voltage / pollution degree	6 KV / 3	6 KV / 3	6 KV / 3			
insulation stripping length (mm)	10	10	10			
height / width / thickness	48 / 66 / 5.2	37 / 82 / 5.2	48 / 82 / 5.2			
height / width / thickness	56 / 66 / 5.2	45 / 82 / 5.2	56 / 82 / 5.2			
height / width / thickness	-	-	-			
APPROVALS						
ACCESSORIES	Type	Cat. No.	Type	Cat. No.	Type	Cat. No.
End sections	grey beige blue	HMT.2/1+2/PT/GR - -	HMT.2/2+2/PT/GR - -	HMT.2/2+2/PT/GR - -	HMT.2/2+2/PT/GR - -	HMT.2/2+2/PT/GR - -
Permanent cross connection	-	-	-	-	-	-
Rated current carrying capacity of jumper (A)	-	-	-	-	-	-
Multiple common bar	250 mm	-	-	-	-	-
Shunting screw and sleeve	-	-	-	-	-	-
Coloured partition	red, green, white	DFH/2	DFH/3	DFH/3	DFH/3	DFH/3
Cross connection barrier	red	-	-	-	-	-
Test plug socket	-	-	-	-	-	-
Test plug	-	SDD/1	SDD/1	SDD/1	SDD/1	SDD/1
Modular test plug	-	SDH/5	SDH/5	SDH/5	SDH/5	SDH/5
End section for modular test plug	-	SH5/PT	SH5/PT	SH5/PT	SH5/PT	SH5/PT
Numbering strip	-	CNU/8/51	CNU/8/51	CNU/8/51	CNU/8/51	CNU/8/51
Screwdriver for activation of the spring	-	CCH/2.5-4	CCH/2.5-4	CCH/2.5-4	CCH/2.5-4	CCH/2.5-4
Warning plate	on adjacent terminal blocks	-	-	-	-	-
Marking tag	printed or blank	CNU/8/51	CNU/8/51	CNU/8/51	CNU/8/51	CNU/8/51
End bracket	-	BTU for PR/DIN and PR/3 BT0 BT/3 for PR/3 only	BTU for PR/DIN and PR/3 BT0 BT/3 for PR/3 only	BTU for PR/DIN and PR/3 BT0 BT/3 for PR/3 only	BTU for PR/DIN and PR/3 BT0 BT/3 for PR/3 only	BTU for PR/DIN and PR/3 BT0 BT/3 for PR/3 only

HMM Series

- UL94V-0
- mounting onto PR/3 type rails according to IEC 60715 standard, TH/35 type
- available in the standard version (grey) or in a version appropriate for use with "intrinsically safe" (Ex)i circuits (blue)
- maximum operating temperature 100°C
- INERIS 16 ATEX 9002U Ex e and I M2 Ex e I Mb II 2G Ex e IIC Gb certificate of operating temperature: -40 – +80 °C
- CoC IECEx INE 16.0032U



For the isolation figures with cross connections refer to the table on page 131

The /GR tag indicates the grey version.

grey version	
(Ex)i version	
TECHNICAL CHARACTERISTICS	
function/type	
rated cross-section	(mm ²)
connecting capacity	
flexible	(mm ²)
rigid	(mm ²)
max. flexible with ferrule (mm ²) - ferrule type	
rated voltage / rated current / gauge	conf. to IEC 60947-7-1
rated voltage / rated current / AWG	UL
rated impulse withstand voltage / pollution degree	
insulation stripping length	(mm)
height / width / thickness	TH/35 7.5 mm
height / width / thickness	TH/35 15 mm
height / width / thickness	G32

APPROVALS

ACCESSORIES	
End sections	grey blue
"Easy Bridge" (PTC) cross connection (intrinsically IPXXB protected once mounted)	
Available also in coloured version (PTP)	
Ref. p. 130	
Rated current carrying capacity of jumper	(A)
Cross-connection identification strip (100 mm)	green
Multiple common bar	250 mm
Shunting screw and sleeve	
Coloured partition	red, green, white
Cross connection barrier	red
Test plug socket	
Test plug	
Modular test plug	
End section for modular test plug	
Numbering strip	
Screwdriver for activation of the spring	
Warning plate	on adjacent terminal blocks
Marking tag	printed or blank
End bracket	

HMM.4/GR	
Cat. No. HM250GR	
HMM.4 (Ex)i	
Cat. No. HI250	
feed-through	
	4
	0.2-6
	0.2-6
	4-WP40/16
	800 V / 32 A / A4
	600 V / 30 A / 24-10 AWG
	8 KV / 3
	12
	45 / 58 / 6.2
	52 / 58 / 6.2
	-



HMM.4/1+2/GR	
Cat. No. HM210GR	
HMM.4/1+2 (Ex)i	
Cat. No. HI210	
feed-through, 1 input and 2 outputs	
	4
	0.2-6
	0.2-6
	4-WP40/16
	800 V / 32 A / A4
	-
	8 KV / 3
	12
	45 / 78 / 6.2
	52 / 78 / 6.2
	-



HMM.4/2+2/GR	
Cat. No. HM220GR	
HMM.4/2+2 (Ex)i	
Cat. No. HI220	
feed-through, 2 inputs and 2 outputs	
	4
	0.2-6
	0.2-6
	4-WP40/16
	800 V / 32 A / A4
	-
	8 KV / 3
	12
	45 / 98 / 6.2
	52 / 98 / 6.2
	-



Type	Cat. No.
HMT.4/PT/GR	HM251GR
HMT.4/PT (Ex)i	HI251
PTC/5/02 poles	PTC0502
PTC/5/03 poles	PTC0503
PTC/5/05 poles	PTC0505
PTC/5/10 poles	PTC0510
PTC/5/00 (40 poles)	PTC0500
32	
PTC/SP	PTC0990
-	
DFH/1	DH01..
-	
SDD/1	DD001
SDH/6	DH006
SH6/PT	DH601
CNU/8/61	NU0861
CCH/2.5-4	CCH02
-	
CNU/8/61	NU0861
BTU for PR/DIN and PR/3	BT005
BTO	BT007
BT/3 for PR/3 only	BT003

Type	Cat. No.
HMT.4/1+2/PT/GR	HM211GR
HMT.4/1+2/PT (Ex)i	HI211
PTC/5/02 poles	PTC0502
PTC/5/03 poles	PTC0503
PTC/5/05 poles	PTC0505
PTC/5/10 poles	PTC0510
PTC/5/00 (40 poles)	PTC0500
32	
PTC/SP	PTC0990
-	
DFH/4	DH04..
-	
SDD/1	DD001
SDH/6	DH006
SH6/PT	DH601
CNU/8/61	NU0861
CCH/2.5-4	CCH02
-	
CNU/8/51	NU0851
BTU for PR/DIN and PR/3	BT005
BTO	BT007
BT/3 for PR/3 only	BT003

Type	Cat. No.
HMT.4/2+2/PT/GR	HM221GR
HMT.4/2+2/PT (Ex)i	HI221
PTC/5/02 poles	PTC0502
PTC/5/03 poles	PTC0503
PTC/5/05 poles	PTC0505
PTC/5/10 poles	PTC0510
PTC/5/00 (40 poles)	PTC0500
32	
PTC/SP	PTC0990
-	
DFH/4	DH04..
-	
SDD/1	DD001
SDH/6	DH006
SH6/PT	DH601
CNU/8/61	NU0861
CCH/2.5-4	CCH02
-	
CNU/8/51	NU0851
BTU for PR/DIN and PR/3	BT005
BTO	BT007
BT/3 for PR/3 only	BT003

HMM Series

- UL94V-0
- mounting onto PR/3 type rails according to IEC 60715 standard, TH/35 type
- available in the standard version (grey) or in a version appropriate for use with "intrinsically safe" (Ex)i circuits (blue)
- maximum operating temperature 100°C
- INERIS 16 ATEX 9002U Ex e and I M2 Ex e I Mb II 2G Ex e IIC Gb certificate of operating temperature: -40 – +80 °C
- CoC IECEx INE 16.0032U



For the isolation figures with cross connections refer to the table on page 131

The /GR tag indicates the grey version.

grey version	
(Ex)i version	
TECHNICAL CHARACTERISTICS	
function/type	
rated cross-section	(mm ²)
connecting capacity	
flexible	(mm ²)
rigid	(mm ²)
max. flexible with ferrule (mm ²) - ferrule type	
rated voltage / rated current / gauge	conf. to IEC 60947-7-1
rated voltage / rated current / AWG	UL
rated impulse withstand voltage / pollution degree	
insulation stripping length	(mm)
height / width / thickness	TH/35 7.5 mm
height / width / thickness	TH/35 15 mm
height / width / thickness	G32

HMM.6/GR	Cat. No. HM320GR
HMM.4 (Ex)i	Cat. No. HI320
feed-through	
6	
0.2–10	
0.2–10	
6–WP60/20	
800 V / 41 A / A5	
600 V / 41 A / 24-8 AWG	
8 KV / 3	
13	
44 / 62 / 8.2	
52 / 62 / 8.2	
-	

HMM.10/GR	Cat. No. HM330GR
HMM.10 (Ex)i	Cat. No. HI330
feed-through	
10	
1.5–16	
1.5–16	
10–WP100/21	
1000 V / 57 A / A6	
-	
12 KV / 3	
18	
53 / 71 / 10	
61 / 71 / 10	
-	

HMM.16/GR	Cat. No. HM340GR
HMM.16 (Ex)i	Cat. No. HI340
feed-through	
16	
1.5–25	
1.5–25	
16–WP160/22	
1000 V / 76 A / A7	
-	
12 KV / 3	
18	
56 / 80 / 12	
64 / 80 / 12	
-	

APPROVALS



ACCESSORIES	
End sections	grey blue
Permanent cross connection (intrinsically IPXXB protected once mounted)	
Rated current carrying capacity of jumper	(A)
Cross-connection identification strip (100 mm)	green
Multiple common bar	250 mm
Shunting screw and sleeve	
Coloured partition	red, green, white
Cross connection barrier	red
Test plug socket	
Test plug	
Modular test plug	
End section for modular test plug	
Numbering strip	
Screwdriver for activation of the spring	
Warning plate	on adjacent terminal blocks
Marking tag	printed or blank
End bracket	

Type	Cat. No.
HMT.6/PT/GR	HM321GR
HMT.6/PT (Ex)i	HI321
PTC/8/02 poles	PTC0802
PTC/8/03 poles	PTC0803
PTC/8/05 poles	PTC0805
PTC/8/10 poles	PTC0810
PTC/8/00 (30 poles)	PTC0800
41	
PTC/SP	PTC0990
-	
DFH/1	DH01..
-	
SDD/1	DD001
-	
CCH/6	CCH06
-	
CNU/8/51	NU0851
BTU for PR/DIN and PR/3	BT005
BTO	BT007
BT/3 for PR/3 only	BT003

Type	Cat. No.
HMT.10/PT/GR	HM331GR
HMT.10/PT (Ex)i	HI331
PTC/11/02 poles	PTC1102
PTC/11/03 poles	PTC1103
PTC/11/05 poles	PTC1105
PTC/11/10 poles	PTC1110
PTC/11/00 (25 poles)	PTC1100
57	
-	
DFH/4	DH04..
-	
SDD/1	DD001
-	
CCH/6	CCH06
-	
CNU/8/51	NU0851
BTU for PR/DIN and PR/3	BT005
BTO	BT007
BT/3 for PR/3 only	BT003

Type	Cat. No.
HMT.16/PT/GR	HM341GR
HMT.16/PT (Ex)i	HI341
PTC/16/02 poles	PTC1602
PTC/16/03 poles	PTC1603
PTC/16/05 poles	PTC1605
PTC/16/10 poles	PTC1610
PTC/16/00 (20 poles)	PTC1600
76	
-	
DFH/4	DH04..
-	
SDD/1	DD001
-	
CCH/6	CCH06
-	
CNU/8/51	NU0851
BTU for PR/DIN and PR/3	BT005
BTO	BT007
BT/3 for PR/3 only	BT003

H Series

potential distributor terminal blocks

- UL94V-0
- 16 mm²
- mounting onto PR/3 type rails according to IEC 60715 standard, TH/35 type
- available in the standard version (grey)
- connectable with the terminal blocks: HMM.2/GR, HMM.2/1+2/GR, HMM.2/2+2/GR, HMS.2/GR, HMFA.2/GR, HMM.4/GR, HMM.4/1+2/GR, HMM.4/2+2/GR, HMM.6/GR
- maximum operating temperature 100°C

(*) value referred to the terminal and not to the potential distributor

The /GR tag indicates the grey version.

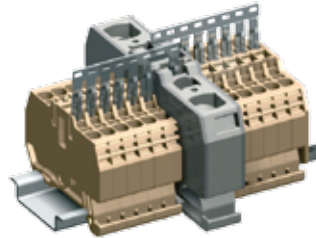

Terminal assembly with double feeding distribution

Connection diagram distributor terminal blocks HMR.16/GR a HMR.16/D/GR

Connection on 2 sides

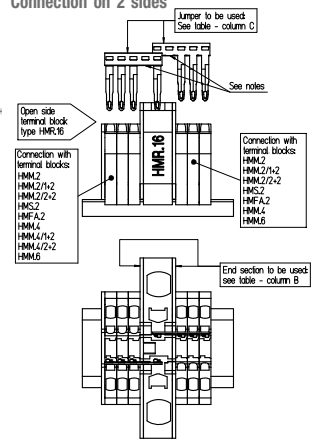

Connection on open sides

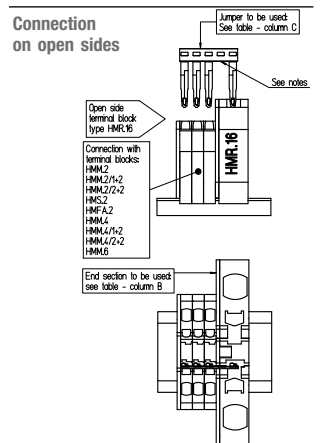

Connection on closed side of distributor

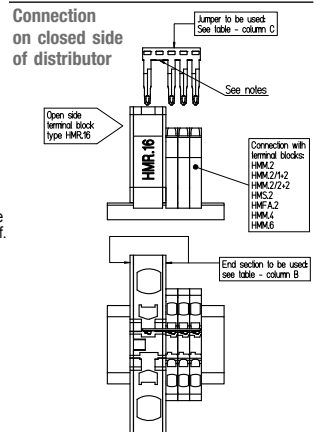

single power supply version	
double supply version	
TECHNICAL CHARACTERISTICS	
function/type	
rated cross-section	(mm ²)
connecting capacity	
flexible	(mm ²)
rigid	(mm ²)
max. flexible with ferrule (mm ²) - ferrule type	
rated voltage / rated current / gauge	conf. to IEC 60947-7-1
rated voltage / rated current / AWG	UL
rated impulse withstand voltage / pollution degree	
insulation stripping length	(mm)
height / width / thickness	TH/35 7.5 mm
height / width / thickness	TH/35 15 mm
height / width / thickness	G32

HMR.16/GR
Cat. No. **HM350GR**
HMR.16/D/GR
Cat. No. **HM360GR**

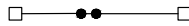

potential distributor
16

1.5-25
1.5-25
16-WP160/22
800 V / 76 A (*) / A7
600 V / 18-4 AWG/ (***)
12 KV / 3
18
50 / 80 / 12.8
57 / 80 / 12.8
-

Cross-connection currents according to UL approval

Column A	Column B	Column C	
Connection to distribution T.B.	End section to be used	Jumpers that can be used	
Type	Type	Cat. No.	Type
HMM.2 HMM.2/1+2 HMM.2/2+2 HMS.2 HMFA.2	HMR.16-2/PT/GR	HM350GR	PTC0303 poles PTC0305 poles PTC0310 poles PTC0300 (47 poles)
			15 A

Column A	Column B	Column C	
Connection to distribution T.B.	End section to be used	Jumpers that can be used	
Type	Type	Cat. No.	Type
HMM.4 HMM.4/1+2 HMM.4/2+2	HMR.16-4/PT/GR	HM354GR	PTC0503 poles PTC0505 poles PTC0510 poles PTC0500 (40 poles)
			20 A

Column A	Column B	Column C	
Connection to distribution T.B.	End section to be used	Jumpers that can be used	
Type	Type	Cat. No.	Type
HMM.6	HMR.16-6/PT/GR	HM356GR	PTC0803 poles PTC0805 poles PTC0810 poles PTC0800 (30 poles)
			30 A

NOTES

The number of poles to be used shall be equal to the number of terminal blocks to be connected, including the distribution terminal block +1 to allow the connection to the distribution terminal block the second pin of the PTC jumper shall be trimmed off.
*Connectable only on the open side of the distribution terminal block

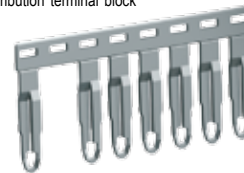

terminal block connected to the distributor	End section		Permanent cross connection (**)		
	ID number	Code	ID number	Code	Total current carrying capacity
HMM.2/GR HMM.2/1+2/GR HMM.2/2+2/GR HMS.2/GR HMFA.2/GR	HMR.16-2/ PT/GR	HM352GR	PTC/03/03 poles PTC/03/05 poles PTC/03/10 poles PTC/03/00 (47 poles)	PTC0303 PTC0305 PTC0310 PTC0300	24 A
HMM.4/GR HMM.4/1+2/GR HMM.4/2+2/GR	HMR.16-4/ PT/GR	HM354GR	PTC/05/03 poles PTC/05/05 poles PTC/05/10 poles PTC/05/00 (40 poles)	PTC0503 PTC0505 PTC0510 PTC0500	32 A
HMM.6/GR	HMR.16-6/ PT/GR	HM356GR	PTC/08/03 poles PTC/08/05 poles PTC/08/10 poles PTC/08/00 (30 poles)	PTC0803 PTC0805 PTC0810 PTC0800	41 A

APPROVALS



ACCESSORIES

End sections	grey
Permanent cross connection	
Rated current carrying capacity of jumper	(A)
Cross-connection identification strip (100 mm)	green
Multiple common bar	250 mm
Shunting screw and sleeve	
Coloured partition	red, green, white
Cross connection barrier	red
Test plug socket	
Test plug	
Numbering strip	
Screwdriver for activation of the spring	
Warning plate	on adjacent terminal blocks

Type	Cat. No.
see table	
see table	
see table	
-	
-	
-	
DFH/4	DH04..
-	
SDD/1	DD001
-	
CCH/6	CCH06
-	
CNU/8/51	NU0851
-	
BTU for PR/DIN and PR/3	BT005
BTO	BT007
BT/3 for PR/3 only	BT003

Marking tag	printed or blank
End bracket	

* "Easy Bridge" (PTC) coupling cross connection system (intrinsically IPXXB when mounted)
Available also in coloured version (PTP)
Ref. p. 131

(**) In order to enable the connection to the supply terminal the second pin must be always removed from the strip of the PTC jumper.

The number of poles of the PTC jumper must be equal to the number of terminal blocks to be cross-connected plus 1

HTE Series

- UL94V-0
- mounting onto PR/3 type rails according to IEC 60715 standard, TH/35 type
- earth, with yellow/green shell
- maximum operating temperature 100°C
- INERIS 16 ATEX 9002U Ex e Ex and I M2 Ex e I Mb II 2G Ex e IIC Gb certificate of operating temperature: -40 – +80 °C
- CoC IECEx INE 16.0032U



yellow/green version

TECHNICAL CHARACTERISTICS

function/type	
rated cross-section	(mm ²)
connecting capacity	
flexible	(mm ²)
rigid	(mm ²)
max. flexible with ferrule (mm ²) - ferrule type	
rated voltage / rated current / gauge	conf. to IEC 60947-7-1
rated voltage / rated current / AWG	UL
rated impulse withstand voltage / pollution degree	
insulation stripping length	(mm)
height / width / thickness	TH/35 7.5 mm
height / width / thickness	TH/35 15 mm
height / width / thickness	G32

APPROVALS

ACCESSORIES

End sections	grey blue
Permanent cross connection	
Rated current carrying capacity of jumper	(A)
Cross-connection identification strip (100 mm)	green
Multiple common bar	250 mm
Shunting screw and sleeve	
Coloured partition	red, green, white
Cross connection barrier	red
Test plug socket	
Test plug	
Modular test plug	
End section for modular test plug	
Numbering strip	
Screwdriver for activation of the spring	
Warning plate	on adjacent terminal blocks
Marking tag	printed or blank
End bracket	

HTE.1 Cat. No. HT400

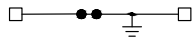

earth	1.5
0.2–2.5	
0.2–2.5	
1.5–WP15/14	
- / - / B2	
- / - / 26-14 AWG	
8 KV / 3	
10	
43 / 50 / 4.2	
51 / 50 / 4.2	
-	



Type Cat. No.

HMT.1/PT/GR	HM401GR
-	
PTC/1/02 poles	PTC0410
PTC/1/03 poles	PTC0410
PTC/1/05 poles	PTC0410
PTC/1/10 poles	PTC0410
PTC/1/00 (50 poles)	PTC0400
17.5	
PTC/SP	PTC0990
-	
DFH/1	DH01..
DFM/500	DF500
-	
SHZ/1	SH004
CCH/2.5-4	CCH02
-	
SHZ/1	SH004
BTU for PR/DIN and PR/3	BT005
BTO	BT007
BT/3 for PR/3 only	BT003

HTE.1/1+2 Cat. No. HT410

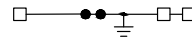

earth, 1 input and 2 outputs	1.5
0.2–2.5	
0.2–2.5	
1.5–WP15/14	
- / - / B2	
- / - / 26-14 AWG	
8 KV / 3	
10	
43 / 61 / 4.2	
51 / 61 / 4.2	
-	



Type Cat. No.

HMT.1/1+2/PT/GR	HM411GR
-	
PTC/1/02 poles	PTC0410
PTC/1/03 poles	PTC0410
PTC/1/05 poles	PTC0410
PTC/1/10 poles	PTC0410
PTC/1/00 (50 poles)	PTC0400
17.5	
PTC/SP	PTC0990
-	
DFH/2	DH02..
DFM/500	DF500
-	
SHZ/1	SH004
CCH/2.5-4	CCH02
-	
SHZ/1	SH004
BTU for PR/DIN and PR/3	BT005
BTO	BT007
BT/3 for PR/3 only	BT003

HTE.1/2+2 Cat. No. HT420

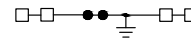

earth, 2 inputs and 2 outputs	1.5
0.2–2.5	
0.2–2.5	
1.5–WP15/14	
- / - / B2	
- / - / 26-14 AWG	
8 KV / 3	
10	
43 / 65 / 4.2	
51 / 65 / 4.2	
-	



Type Cat. No.

HMT.1/2+2/PT/GR	HM421GR
-	
PTC/1/02 poles	PTC0410
PTC/1/03 poles	PTC0410
PTC/1/05 poles	PTC0410
PTC/1/10 poles	PTC0410
PTC/1/00 (50 poles)	PTC0400
17.5	
PTC/SP	PTC0990
-	
DFH/3	DH03..
DFM/500	DF500
-	
SHZ/1	SH004
CCH/2.5-4	CCH02
-	
SHZ/1	SH004
BTU for PR/DIN and PR/3	BT005
BTO	BT007
BT/3 for PR/3 only	BT003

HTE Series

- UL94V-0
- mounting onto PR/3 type rails according to IEC 60715 standard, TH/35 type
- earth, with yellow/green shell
- maximum operating temperature 100°C
- INERIS 16 ATEX 9002U Ex e Ex and I M2 Ex e I Mb II 2G Ex e IIC Gb certificate of operating temperature: -40 – +80 °C
- CoC IECEx INE 16.0032U



standard version

TECHNICAL CHARACTERISTICS

function/type	
rated cross-section	(mm ²)
connecting capacity	
flexible	(mm ²)
rigid	(mm ²)
max. flexible with ferrule (mm ²) - ferrule type	
rated voltage / rated current / gauge	conf. to IEC 60947-7-1
rated voltage / rated current / AWG	UL
rated impulse withstand voltage / pollution degree	
insulation stripping length	(mm)
height / width / thickness	TH/35 7.5 mm
height / width / thickness	TH/35 15 mm
height / width / thickness	G32

APPROVALS

ACCESSORIES

End sections	grey blue
"Easy Bridge" (PTC) cross connection (intrinsically IPXXB protected once mounted)	
Available also in coloured version (PTP)	
Ref. p. 130	
Rated current carrying capacity of jumper	(A)
Cross-connection identification strip (100 mm)	green
Multiple common bar	250 mm
Shunting screw and sleeve	
Coloured partition	red, green, white
Cross connection barrier	red
Test plug socket	
Test plug	
Modular test plug	
End section for modular test plug	
Numbering strip	
Screwdriver for activation of the spring	
Warning plate	on adjacent terminal blocks
Marking tag	printed or blank
End bracket	

HTE.2

Cat. No. **HT500**

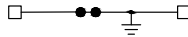

earth	2.5
0.2-4	
0.2-4	
2.5-WP25/14	
- / - / A3	
- / - / 24-12 AWG	
8 KV / 3	
10	
41 / 54 / 5.2	
49 / 54 / 5.2	
-	



Type	Cat. No.
HMT.2/PT/GR	HM501GR
-	
PTC/03/02 poles	PTC0302
PTC/03/03 poles	PTC0303
PTC/03/05 poles	PTC0305
PTC/03/10 poles	PTC0310
PTC/03/00 (47 poles)	PTC0300
24	
PTC/SP	PTC0990
-	
DFH/1	DH01..
-	
SDD/1	DD001
-	
-	
CNU/8/51	NU0851
CCH/2.5-4	CCH02
-	
CNU/8/51	NU0851
BTU for PR/DIN and PR/3	BT005
BTO	BT007
BT/3 for PR/3 only	BT003

HTE.2/1+2

Cat. No. **HT510**

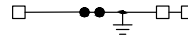

earth, 1 input and 2 outputs	2.5
0.2-4	
0.2-4	
2.5-WP25/14	
- / - / A3	
- / - / 24-12 AWG	
8 KV / 3	
10	
41 / 70 / 5.2	
49 / 70 / 5.2	
-	



Type	Cat. No.
HMT.2/1+2/PT/GR	HM511GR
-	
PTC/03/02 poles	PTC0302
PTC/03/03 poles	PTC0303
PTC/03/05 poles	PTC0305
PTC/03/10 poles	PTC0310
PTC/03/00 (47 poles)	PTC0300
24	
PTC/SP	PTC0990
-	
DFH/2	DH02..
-	
SDD/1	DD001
-	
-	
CNU/8/51	NU0851
CCH/2.5-4	CCH02
-	
CNU/8/51	NU0851
BTU for PR/DIN and PR/3	BT005
BTO	BT007
BT/3 for PR/3 only	BT003

HTE.2/2+2

Cat. No. **HT520**

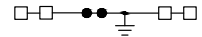

earth, 2 inputs and 2 outputs	2.5
0.2-4	
0.2-4	
2.5-WP25/14	
- / - / A3	
- / - / 24-12 AWG	
8 KV / 3	
10	
41 / 82 / 5.2	
49 / 82 / 5.2	
-	



Type	Cat. No.
HMT.2/2+2/PT/GR	HM521GR
-	
PTC/03/02 poles	PTC0302
PTC/03/03 poles	PTC0303
PTC/03/05 poles	PTC0305
PTC/03/10 poles	PTC0310
PTC/03/00 (47 poles)	PTC0300
24	
PTC/SP	PTC0990
-	
DFH/3	DH03..
-	
SDD/1	DD001
-	
-	
CNU/8/51	NU0851
CCH/2.5-4	CCH02
-	
CNU/8/51	NU0851
BTU for PR/DIN and PR/3	BT005
BTO	BT007
BT/3 for PR/3 only	BT003

HTE Series

- UL94V-0
- mounting onto PR/3 type rails according to IEC 60715 standard, TH/35 type
- earth, with yellow/green shell
- maximum operating temperature 100°C
- INERIS 16 ATEX 9002U Ex e and I M2 Ex e I Mb II 2G Ex e IIC Gb certificate of operating temperature: -40 – +80 °C
- CoC IECEx INE 16.0032U



standard version

TECHNICAL CHARACTERISTICS

function/type	
rated cross-section	(mm ²)
connecting capacity	
flexible	(mm ²)
rigid	(mm ²)
max. flexible with ferrule (mm ²) - ferrule type	
rated voltage / rated current / gauge	conf. to IEC 60947-7-1
rated voltage / rated current / AWG	UL
rated impulse withstand voltage / pollution degree	
insulation stripping length	(mm)
height / width / thickness	TH/35 7.5 mm
height / width / thickness	TH/35 15 mm
height / width / thickness	G32

APPROVALS

ACCESSORIES

End sections	grey blue
"Easy Bridge" (PTC) cross connection (intrinsically IPXXB protected once mounted)	
Available also in coloured version (PTP)	
Ref. p. 130	
Rated current carrying capacity of jumper	(A)
Cross-connection identification strip (100 mm)	green
Multiple common bar	250 mm
Shunting screw and sleeve	
Coloured partition	red, green, white
Cross connection barrier	red
Test plug socket	
Test plug	
Modular test plug	
End section for modular test plug	
Numbering strip	
Screwdriver for activation of the spring	
Warning plate	on adjacent terminal blocks
Marking tag	printed or blank
End bracket	

HTE.4

Cat. No. **HT250**

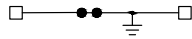

earth	4
0.2-6	
0.2-6	
4-WP40/16	
- / - / A4	
- / - / 24-10 AWG	
8 KV / 3	
12	
45 / 58 / 6.2	
52 / 58 / 6.2	
-	



Type	Cat. No.
HMT.4/PT/GR	HM251GR
-	
PTC/5/02 poles	PTC0502
PTC/5/03 poles	PTC0503
PTC/5/05 poles	PTC0505
PTC/5/10 poles	PTC0510
PTC/5/00 (40 poles)	PTC0500
32	
PTC/SP	PTC0990
-	
DFH/1	DH01..
-	
SDD/1	DD001
-	
-	
CNU/8/61	NU0861
CCH/2.5-4	CCH02
-	
CNU/8/61	NU0861
BTU for PR/DIN and PR/3	BT005
BTO	BT007
BT/3 for PR/3 only	BT003

HTE.4/1+2

Cat. No. **HT260**

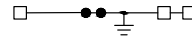

earth, 1 input and 2 outputs	4
0.2-6	
0.2-6	
4-WP40/16	
- / - / A4	
-	
8 KV / 3	
12	
45 / 78 / 6.2	
52 / 78 / 6.2	
-	



Type	Cat. No.
HMT.4/1+2/PT/GR	HM211GR
-	
PTC/5/02 poles	PTC0502
PTC/5/03 poles	PTC0503
PTC/5/05 poles	PTC0505
PTC/5/10 poles	PTC0510
PTC/5/00 (40 poles)	PTC0500
32	
PTC/SP	PTC0990
-	
DFH/1	DH01..
-	
SDD/1	DD001
-	
-	
CNU/8/61	NU0861
CCH/2.5-4	CCH02
-	
CNU/8/61	NU0861
BTU for PR/DIN and PR/3	BT005
BTO	BT007
BT/3 for PR/3 only	BT003

HTE.4/2+2

Cat. No. **HT270**

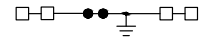

earth, 2 inputs and 2 outputs	4
0.2-6	
0.2-6	
4-WP40/16	
- / - / A4	
-	
8 KV / 3	
12	
45 / 98 / 6.2	
52 / 98 / 6.2	
-	



Type	Cat. No.
HMT.4/2+2/PT/GR	HM221GR
-	
PTC/5/02 poles	PTC0502
PTC/5/03 poles	PTC0503
PTC/5/05 poles	PTC0505
PTC/5/10 poles	PTC0510
PTC/5/00 (40 poles)	PTC0500
32	
PTC/SP	PTC0990
-	
DFH/1	DH01..
-	
SDD/1	DD001
-	
-	
CNU/8/61	NU0861
CCH/2.5-4	CCH02
-	
CNU/8/61	NU0861
BTU for PR/DIN and PR/3	BT005
BTO	BT007
BT/3 for PR/3 only	BT003

HTE Series

- UL94V-0
- mountingd onto PR/3 type rails according to IEC 60711 standard, TH/35 type
- earth, with yellow/green shell
- maximum operating temperature 100°C
- INERIS 16 ATEX 9002U Ex e Ex and I M2 Ex e I Mb II 2G Ex e IIC Gb certificate of operating temperature: -40 – +80 °C
- CoC IECEx INE 16.0032U



standard version

TECHNICAL CHARACTERISTICS

function/type	
rated cross-section	(mm ²)
connecting capacity	
flexible	(mm ²)
rigid	(mm ²)
max. flexible with ferrule (mm ²) - ferrule type	
rated voltage / rated current / gauge	conf. to IEC 60947-7-1
rated voltage / rated current / AWG	UL
rated impulse withstand voltage / pollution degree	
insulation stripping length	(mm)
height / width / thickness	TH/35 7,5 mm
height / width / thickness	TH/35 15 mm
height / width / thickness	G32

APPROVALS

ACCESSORIES

End sections	grey blue
“Easy Bridge” (PTC) cross connection (intrinsically IPXXB protected once mounted)	
Available also in coloured version (PTP)	
Ref. p. 130	
Rated current carrying capacity of jumper	(A)
Cross-connection identification strip (100 mm)	green
Multiple common bar	250 mm
Shunting screw and sleeve	
Coloured partition	red, green, white
Cross connection barrier	red
Test plug socket	
Test plug	
Modular test plug	
End section for modular test plug	
Numbering strip	
Screwdriver for activation of the spring	
Warning plate	on adjacent terminal blocks
Marking tag	printed or blank
End bracket	

HTE.6

Cat. No. **HT320**

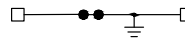

earth	6
0.2–10	0.2–10
6–WP60/20	6–WP60/20
- / - / A5	- / - / A5
- / - / 24-8 AWG	- / - / 24-8 AWG
8 KV / 3	8 KV / 3
13	13
44 / 62 / 8.2	44 / 62 / 8.2
52 / 62 / 8.2	52 / 62 / 8.2
-	-



Type	Cat. No.
HMT.6/PT/GR	HM321GR
-	-
PTC.8/02 poles	PTC0802
PTC.8/03 poles	PTC0803
PTC.8/05 poles	PTC0805
PTC.8/10 poles	PTC0810
PTC.8/00 (30 poles)	PTC0800
41	
PTC/SP	PTC0990
-	-
-	-
DFH/1	DH01..
-	-
-	-
SDD/1	DD001
-	-
-	-
-	-
CCH/6	CCH06
-	-
CNU.8/51	NU0851
-	-
BTU for PR/DIN and PR/3	BT005
BTO	BT007
BT/3 for PR/3 only	BT003

HTE.10

Cat. No. **HT330**

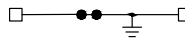

earth	10
1.5–16	1.5–16
10–WP100/21	10–WP100/21
- / - / A6	- / - / A6
-	-
12 KV / 3	12 KV / 3
18	18
53 / 71 / 10	53 / 71 / 10
61 / 70 / 10	61 / 70 / 10
-	-



Type	Cat. No.
HMT.10/PT	HM331GR
-	-
PTC.11/02 poles	PTC1102
PTC.11/03 poles	PTC1103
PTC.11/05 poles	PTC1105
PTC.11/10 poles	PTC1110
PTC.11/00 (25 poles)	PTC1100
57	
-	-
-	-
DFH/4	DH04..
-	-
-	-
SDD/1	DD001
-	-
-	-
-	-
CCH/6	CCH06
-	-
CNU.8/51	NU0851
-	-
BTU for PR/DIN and PR/3	BT005
BTO	BT007
BT/3 for PR/3 only	BT003

HTE.16

Cat. No. **HT340**

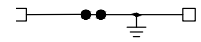

earth	16
1.5–25	1.5–25
16–WP160/22	16–WP160/22
- / - / A7	- / - / A7
-	-
12 KV / 3	12 KV / 3
18	18
56 / 80 / 12	56 / 80 / 12
64 / 80 / 12	64 / 80 / 12
-	-



Type	Cat. No.
HMT.16/PT	HM341GR
-	-
PTC.16/02 poles	PTC1602
PTC.16/03 poles	PTC1603
PTC.16/05 poles	PTC1605
PTC.16/10 poles	PTC1610
PTC.16/00 (20 poles)	PTC1600
76	
-	-
-	-
DFH/4	DH04..
-	-
-	-
SDD/1	DD001
-	-
-	-
-	-
CCH/6	CCH06
-	-
CNU.8/51	NU0851
-	-
BTU for PR/DIN and PR/3	BT005
BTO	BT007
BT/3 for PR/3 only	BT003

H Series

- UL94V-0
- mounting onto PR/3 type rails according to IEC 60715 standard, TH/35 type
- double possible insertion of the "Easy Bridge" multi-polar connection system - PTC cross connection, on each of the two levels
- available in the standard version (grey) or in a version appropriate for use with "intrinsically safe" (Ex)i circuits (blue), where indicated
- maximum operating temperature 100°C
- INERIS 16 ATEX 9002U Ex e and I M2 Ex e I Mb II 2G Ex e IIC Gb certificate of operating temperature: -40 – +80 °C
- CoC IECEx INE 16.0032U

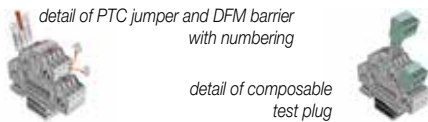

The /GR tag indicates the grey version.

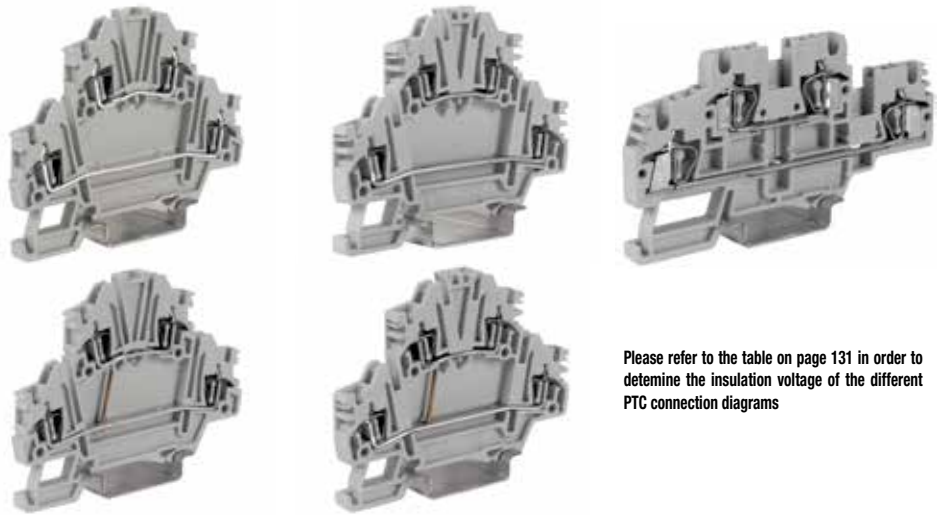

Please refer to the table on page 131 in order to determine the insulation voltage of the different PTC connection diagrams

grey version	
(Ex)i version	
version with permanent internal connection	
TECHNICAL CHARACTERISTICS	
function/type	
rated cross-section	(mm ²)
connecting capacity	
flexible	(mm ²)
rigid	(mm ²)
max. flexible with ferrule (mm ²) - ferrule type	
rated voltage / rated current / gauge	conf. to IEC 60947-7-1
rated voltage / rated current / AWG	UL
rated impulse withstand voltage / pollution degree	
insulation stripping length	(mm)
height / width / thickness	TH/35 7.5 mm
height / width / thickness	TH/35 15 mm
height / width / thickness	G32

APPROVALS



ACCESSORIES	
End sections	grey blue
"Easy Bridge" (PTC) cross connection (intrinsically IPXXB protected once mounted)	
Available also in coloured version (PTP)	
Ref. p. 130	
Rated current carrying capacity of jumper	(A)
Cross-connection identification strip (100 mm)	green
Internal cross connection (removable)	
Shunting screw and sleeve	
Coloured partition	red, green, white
Cross connection barrier	red
Test plug socket	
Test plug	
Modular test plug	
End section for modular test plug	
Numbering strip	
Screwdriver for activation of the spring	
Warning plate	on adjacent terminal blocks
Marking tag	printed or blank
End bracket	

HMD.1/GR	Cat. No. HD200GR
HMD.1 (Ex)i	Cat. No. HD300
HMD.1/CI/GR	Cat. No. HD120GR

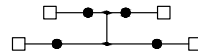

two-level feed-through	1.5
flexible	0.2–2.5
rigid	0.2–2.5
max. flexible with ferrule (mm ²) - ferrule type	1.5–WP15/14
rated voltage / rated current / gauge	500 V / 17.5 A / B2
rated voltage / rated current / AWG	600 V / 15 A / 26-14 AWG
rated impulse withstand voltage / pollution degree	6 KV / 3
insulation stripping length	10
height / width / thickness	59 / 73 / 4.2
height / width / thickness	67 / 73 / 4.2
height / width / thickness	-

HMD.2N/GR	Cat. No. HD400GR
HMD.2N (Ex)i	Cat. No. HD410
HMD.2N/CI/GR	Cat. No. HD450GR

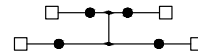

two-level feed-through	2.5
flexible	0.2–2.5
rigid	0.2–2.5
max. flexible with ferrule (mm ²) - ferrule type	1.5–WP15/14
rated voltage / rated current / gauge	630 V / 24 A / B2
rated voltage / rated current / AWG	600 V / 15 A / 26-14 AWG
rated impulse withstand voltage / pollution degree	8 KV / 3
insulation stripping length	10
height / width / thickness	59 / 73 / 5.2
height / width / thickness	67 / 73 / 5.2
height / width / thickness	-

HMD.2/GR	Cat. No. HD100GR
-----------------	-------------------------

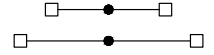

two-level feed-through	2.5
flexible	0.2–4
rigid	0.2–4
max. flexible with ferrule (mm ²) - ferrule type	1.5–WP15/14
rated voltage / rated current / gauge	600 V / 24 A / A3
rated voltage / rated current / AWG	600 V / 20 A / 24-12 AWG
rated impulse withstand voltage / pollution degree	8 KV / 3
insulation stripping length	10
height / width / thickness	49 / 91 / 5.2
height / width / thickness	56 / 91 / 5.2
height / width / thickness	-

Type	Cat. No.
HMD.1/PT/GR	HD201GR
HMD.1/PT (Ex)i	HD301
PTC/1/02 poles	PTC0410
PTC/1/03 poles	PTC0410
PTC/1/05 poles	PTC0410
PTC/1/10 poles	PTC0410
PTC/1/00 (50 poles)	PTC0400
17.5	
PTC/SP	PTC0990
-	
DFU/07	DU07..
DFM/500	DF500
-	
SDH/4-SDH/4P	DH004-DH04P
SH4/PT	DH401
SHZ/1	SH004
CCH/2.5-4	CCH02
-	
SHZ/1	SH004
BTU for PR/DIN and PR/3	BT005
BTO	BT007
BT/3 for PR/3 only	BT003

Type	Cat. No.
HMD.1/PT/GR	HD201GR
HMD.1/PT (Ex)i	HD301
PTC/03/02 poles	PTC0302
PTC/03/03 poles	PTC0303
PTC/03/05 poles	PTC0305
PTC/03/10 poles	PTC0310
PTC/03/00 (50 poles)	PTC0300
24	
PTC/SP	PTC0990
-	
DFU/07	DU07..
DFM/500	DF500
-	
SDH/7	DH007
SH7/PT	DH701
CNU/8/51	NU0851
CCH/2.5-4	CCH02
-	
CNU/8/51	NU0851
BTU for PR/DIN and PR/3	BT005
BTO	BT007
BT/3 for PR/3 only	BT003

Type	Cat. No.
HMD/PT/GR	HD101GR
-	
PH/2.5-4	PH100
PHD/2	PHD02
-	
24	
-	
PHD/2	PHD02
-	
DFH/4	DH04..
-	
-	
SDD/1	DD001
-	
-	
CNU/8/51	NU0851
CCH/2.5-4	CCH02
-	
CNU/8/51	NU0851
(only on lower level)	
BTU for PR/DIN and PR/3	BT005
BTO	BT007
BT/3 for PR/3 only	BT003

H Series

- UL94V-0
- versions made ready for housing electronic components
- mounting onto PR/3 type rails according to IEC 60715 standard, TH/35 type
- available in the standard version (grey) or in a version appropriate for use with "intrinsically safe" (Ex)i circuits (blue), where indicated
- maximum operating temperature 100°C

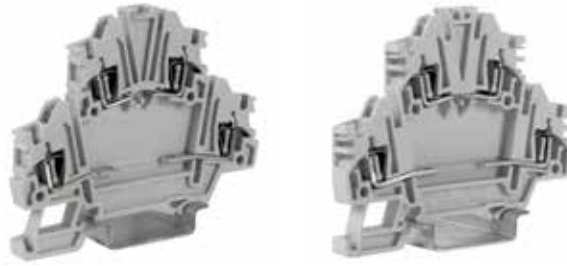

(* values referred to the insulation characteristics of the terminal block and to the connection unit

The /GR tag indicates the grey version.

max. thickness of the mounted components: 3.4 mm

max. thickness of the mounted components: 3.9 mm

grey version	
TECHNICAL CHARACTERISTICS	
function/type	
rated cross-section	(mm ²)
connecting capacity	
flexible	(mm ²)
rigid	(mm ²)
max. flexible with ferrule (mm ²) - ferrule type	
rated voltage / rated current / gauge	conf. to IEC 60947-7-1
rated voltage / rated current / AWG	UL
rated impulse withstand voltage / pollution degree	
insulation stripping length	(mm)
height / width / thickness	TH/35 7.5 mm
height / width / thickness	TH/35 15 mm
height / width / thickness	G32

HMD.1/X/GR	
Cat. No. HD130GR	
two level, arranged to contain electronic components	
1.5	
0.2-2.5	
0.2-2.5	
1.5-WP15/14	
500 V (*) / 17.5 A (*) / B2	
6 kV / 3 (*)	
10	
59 / 73 / 4.2	
67 / 73 / 4.2	
-	

HMD.2N/X/GR	
Cat. No. HD440GR	
two level, arranged to contain electronic components	
2.5	
0.2-2.5	
0.2-2.5	
1.5-WP15/14	
630 V (*) / 24 A (*) / B2	
-	
6 kV / 3 (*)	
10	
59 / 73 / 5.2	
67 / 73 / 5.2	
-	

HMD.2N/DD/GR	
Cat. No. HD420GR	
version equipped with two 1N4007 diodes in feed-through configuration for each level	

APPROVALS



ACCESSORIES	
End sections	grey beige
Permanent cross connection (intrinsically IPXXB protected once mounted)	
Rated current carrying capacity of jumper	(A)
Multiple common bar	250 mm
Shunting screw and sleeve	
Coloured partition	red, green, white
Cross connection barrier	red
Test plug socket	
Test plug	
Modular test plug	
End section for modular test plug	
Numbering strip	
Screwdriver for activation of the spring	
Warning plate	on adjacent terminal blocks
Marking tag	printed or blank
End bracket	

Type	Cat. No.
HMD.1/PT/GR	HD201GR
-	-
PTC/1/02 poles	PTC0410
PTC/1/03 poles	PTC0410
PTC/1/05 poles	PTC0410
PTC/1/10 poles	PTC0410
PTC/1/00 (50 poles)	PTC0400
17.5	
-	-
-	-
DFU/7	DU07..
DFM/500	DF500
-	-
-	-
SDH/4-SDH/4P	DH004-DH04P
SH4/PT	DH401
SHZ/1	SH004
CCH/2.5-4	CCH02
-	-
SHZ/1	SH004
BTU for PR/DIN and PR/3	BT005
BT0	BT007
BT/3 for PR/3 only	BT003

Type	Cat. No.
HMD.1/PT/GR	HD201GR
-	-
PTC/03/02 poles	PTC0302
PTC/03/03 poles	PTC0303
PTC/03/05 poles	PTC0305
PTC/03/10 poles	PTC0310
PTC/03/00 (50 poles)	PTC0300
24	
-	-
-	-
DFU/7	DU07..
DFM/500	DF500
-	-
-	-
SDH/7	DH007
SH7/PT	DH701
CNU/8/51	NU0851
CCH/2.5-4	CCH02
-	-
CNU/8/51	NU0851
BTU for PR/DIN and PR/3	BT005
BT0	BT007
BT/3 for PR/3 only	BT003

HMD.2/3DC/GR	
code HD430GR	
version equipped with three 1N4007 diodes and shared cathode	

H Series

- UL94V-0
- version made ready to host the modular test plug/connector and electronic components
- mounting onto PR/3 type rails according to IEC 60715 standard, TH/35 type
- available in the standard version (grey) or in a version appropriate for use with "intrinsically safe" (Ex)i circuits (blue), where indicated
- maximum operating temperature 100°C

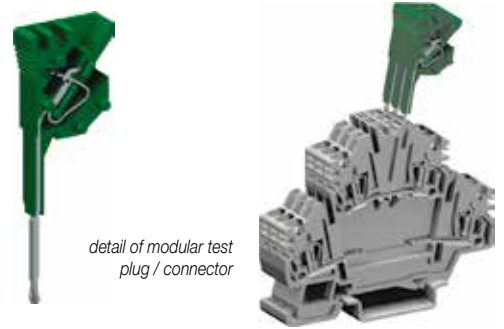

detail of modular test plug / connector

The /GR tag indicates the grey version.

max. thickness of the mounted components:
3.9 mm

grey version	
TECHNICAL CHARACTERISTICS	
function/type	
rated cross-section	(mm ²)
connecting capacity	
flexible	(mm ²)
rigid	(mm ²)
max. flexible with ferrule (mm ²) - ferrule type	
rated voltage / rated current / gauge	conf. to IEC 60947-7-1
rated voltage / rated current / AWG	UL
rated impulse withstand voltage / pollution degree	
insulation stripping length	(mm)
height / width / thickness	TH/35 7.5 mm
height / width / thickness	TH/35 15 mm
height / width / thickness	G32

HMD.2N/X1/GR
Cat. No. **HD441GR**

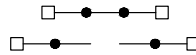

two-level, upper feed-through and lower disconnect
2.5

0.2–2.5
0.2–2.5
1.5–WP15/14
630 V / 24 A / B2
-
8 KV / 3
10
59 / 73 / 5.2
67 / 73 / 5.2
-

APPROVALS



ACCESSORIES	
End sections	grey beige
Permanent cross connection (intrinsically IPXXB protected once mounted)	
Rated current carrying capacity of jumper	(A)
Jumper marking strip	100 mm
Multiple common bar	250 mm
Shunting screw and sleeve	
Coloured partition	red, green, white
Cross connection barrier	red
Test plug socket	
Test plug	
Modular test plug	
End section for modular test plug	
Numbering strip	
Screwdriver for activation of the spring	
Warning plate	on adjacent terminal blocks
Marking tag	printed or blank
End bracket	

Type	Cat. No.
HMD.1/PT/GR	HD201GR
-	
PTC/03/02 poles	PTC0302
PTC/03/03 poles	PTC0303
PTC/03/05 poles	PTC0305
PTC/03/10 poles	PTC0310
PTC/03/00 (47 poles)	PTC0300
24	
PTC/SP	PTC0990
-	
-	
DFU/7	DU07..
DFM/500	DF500
-	
-	
SDH/7	DH007
SH7/PT	DH701
CNU/8/51	NU0851
CCH/2.5-4	CCH02
-	
CNU/8/51	NU0851
BTU for PR/DIN and PR/3	BT005
BTO	BT007
BT/3 for PR/3 only	BT003

H Series

- mounted onto PR/3 profiles conforming to IEC 60715 standards, TH/35 type
- with three stacked / two feed-through circuits + earth
- available in grey or earth with yellow/green shell
- patented "Easy Bridge" system: possibility of inserting modular multi-pole cross connections (PTCs), with no need for additional protections
- **HLD.2** and **HDE.2**: possibility of housing electronic components among the three levels - max. thickness of insertable components: 3.9 mm
- can be coupled together
- maximum operating temperature 100°C
- INERIS 16 ATEX 9002U Ex e and I M2 Ex e I Mb II 2G Ex e IIC Gb certificate operating temperature: -40 – +80 °C
- CoC IECEx INE 16.0032U



For the isolation figures with cross connections refer to the table on page 131

The **/GR** tag indicates the grey version.

grey version (/earth)	
version with internal connection	
(Ex)i version	
TECHNICAL CHARACTERISTICS	
function/type	
rated cross-section	(mm ²)
connecting capacity	
flexible	(mm ²)
rigid	(mm ²)
max. flexible with ferrule (mm ²) - ferrule type	
rated voltage / rated current / gauge	conf. to IEC 60947-7-1
rated voltage / rated current / AWG	UL
rated impulse withstand voltage / pollution degree	
insulation stripping length	(mm)
tightening torque value (test / max)	(Nm)
height / width / thickness	TH/35 7.5 mm
height / width / thickness	TH/35 15 mm
height / width / thickness	G32

HLD.2/GR	Cat. No. HL200GR
HLD.2/CI/GR	Cat. No. HL210GR
HLD.2 (Ex)i	Cat. No. HD510

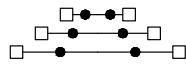

Three feed-through levels	2.5
0.2–2.5	
0.2–2.5	
1.5–WP15/14	
500 V / 24 A / B2	
-	
8 KV / 3	
10	
-	
75 / 95 / 5.2	
83 / 95 / 5.2	
-	

HDE.2/GR	Cat. No. HL500GR
-----------------	-------------------------

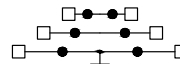

Two feed-through levels + earth	2.5
0.2–2.5	
0.2–2.5	
1.5–WP15/14	
500 V / 24 A / B2	
-	
8 KV / 3	
10	
-	
75 / 95 / 5.2	
83 / 95 / 5.2	
-	

HTTE.2	Cat. No. HLT500
---------------	------------------------

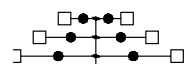

Three cross-connected earth levels	2.5
0.2–2.5	
0.2–2.5	
1.5–WP15/14	
- / - / B2	
-	
8 KV / 3	
10	
-	
75 / 95 / 5.2	
83 / 95 / 5.2	
-	

APPROVALS

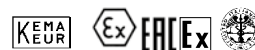

ACCESSORIES	
End sections	grey blue
"Easy Bridge" (PTC) cross connection (intrinsically IPXXB protected once mounted) Available also in coloured version (PTP) Ref. p. 130	
Rated current carrying capacity of jumper	(A)
Cross-connection identification strip (100 mm)	green
Jumper barrier	
Coloured partition	red, green, white
Test plug socket	
Numbering strip	
Screwdriver for activation of the spring	
Screw and sleeve for short-circuit plates (with socket)	
Marking tag	printed or blank
End bracket	

Type	Cat. No.
HLD.2/PT/GR	HL201GR
-	
PTC/03/02 poles	PTC0302
PTC/03/03 poles	PTC0303
PTC/03/05 poles	PTC0305
PTC/03/10 poles	PTC0310
PTC/03/00 (47 poles)	PTC0300
24	
-	
DFM/500	DF500
-	
CNU/8/51	NU0851
CCH/2.5-4	CCH02
-	
CNU/8/51	NU0851
-	
BTU for PR/DIN and PR/3	BT005
BTO	BT007
BT/3 for PR/3 only	BT003

Type	Cat. No.
HLD.2/PT/GR	HL201GR
-	
PTC/03/02 poles	PTC0302
PTC/03/03 poles	PTC0303
PTC/03/05 poles	PTC0305
PTC/03/10 poles	PTC0310
PTC/03/00 (47 poles)	PTC0300
24	
-	
DFM/500	DF500
-	
CNU/8/51	NU0851
CCH/2.5-4	CCH02
-	
CNU/8/51	NU0851
-	
BTU for PR/DIN and PR/3	BT005
BTO	BT007
BT/3 for PR/3 only	BT003

Type	Cat. No.
HLD.2/PT/GR	HL201GR
-	
PTC/03/02 poles	PTC0302
PTC/03/03 poles	PTC0303
PTC/03/05 poles	PTC0305
PTC/03/10 poles	PTC0310
PTC/03/00 (47 poles)	PTC0300
24	
-	
DFM/500	DF500
-	
CNU/8/51	NU0851
CCH/2.5-4	CCH02
-	
CNU/8/51	NU0851
-	
BTU for PR/DIN and PR/3	BT005
BTO	BT007
BT/3 for PR/3 only	BT003

H Series

- UL94V-0
- disconnect by lever and by slide link
- for test and measurement circuits
- mounting onto PR/3 type rails according to IEC 60715 standard, TH/35 type
- available in the standard version (grey) or in a version appropriate for use with "intrinsically safe" (Ex)i circuits (blue), where indicated
- maximum operating temperature 100°C

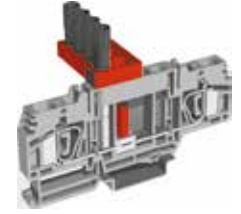

For the isolation figures with cross connections refer to the table on page 131

The /GR tag indicates the grey version.

grey version	
TECHNICAL CHARACTERISTICS	
function/type	
rated cross-section	(mm ²)
connecting capacity	
flexible	(mm ²)
rigid	(mm ²)
max. flexible with ferrule (mm) - ferrule type	
rated voltage / rated current / gauge	conf. to IEC 60947-7-1
rated voltage / rated current / AWG	UL
rated impulse withstand voltage / pollution degree	
insulation stripping length	(mm)
tightening torque value (test / max)	(Nm)
height / width / thickness	TH/35 7.5 mm
height / width / thickness	TH/35 15 mm
height / width / thickness	G32

APPROVALS

ACCESSORIES	
End sections	grey beige blue
"Easy Bridge" (PTC) cross connection (intrinsically IPXXB protected once mounted) Available also in coloured version (PTP) Ref. p. 130	
Rated current carrying capacity of jumper	(A)
Cross-connection identification strip (100 mm)	green
Jumper barrier	
Internal connection	
Coloured partition	red, green, white
Test plug socket	
Test plug	
Modular test plug	
Numbering strip	
Conducting element	
Closing element for modular test plug	
Warning element	
Screwdriver for activation of the spring	
Screw and sleeve for short-circuit plates (with socket)	
Short-circuit plate	between 2 adjoining terminal blocks between 4 adjoining terminal blocks
Marking tag	printed or blank
End bracket	

HMS.2/GR

Cat. No. **HS200GR**

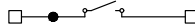

disconnect by lever	2.5
connecting capacity	
flexible	0.2-4
rigid	0.2-4
max. flexible with ferrule (mm) - ferrule type	2.5-WP25/14
rated voltage / rated current / gauge	400 V / 16 A / A3
rated voltage / rated current / AWG	600 V / 24 A / 24-12 AWG
rated impulse withstand voltage / pollution degree	6 KV / 3
insulation stripping length	10
tightening torque value (test / max)	-
height / width / thickness	37 / 66 / 5.2
height / width / thickness	45 / 66 / 5.2
height / width / thickness	-



HSCB.4/GR

Cat. No. **HB100GR**

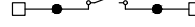

disconnect by slide link	4
connecting capacity	
flexible	0.2-6
rigid	0.2-6
max. flexible with ferrule (mm) - ferrule type	4-WP40/16
rated voltage / rated current / gauge	800 V / 32 A / A4
rated voltage / rated current / AWG	600 V / 30 A / 28-10 AWG
rated impulse withstand voltage / pollution degree	6 KV / 3
insulation stripping length	12
tightening torque value (test / max)	6.2
height / width / thickness	45 / 86 / 6.2
height / width / thickness	53 / 86 / 6.2
height / width / thickness	-



HSCB.6/GR

Cat. No. **HB200GR**



disconnect by slide link	6
connecting capacity	
flexible	0.2-10
rigid	0.2-10
max. flexible with ferrule (mm) - ferrule type	6-WP60/20
rated voltage / rated current / gauge	800 V / 41 A / A5
rated voltage / rated current / AWG	-
rated impulse withstand voltage / pollution degree	6 KV / 3
insulation stripping length	13
tightening torque value (test / max)	8.2
height / width / thickness	48 / 97 / 8.2
height / width / thickness	56 / 97 / 8.2
height / width / thickness	-



Type	Cat. No.
HMT.2/1+2/PT/GR	HM511GR
-	-
PTC/03/02 poles	PTC0302
PTC/03/03 poles	PTC0303
PTC/03/05 poles	PTC0305
PTC/03/10 poles	PTC0310
PTC/03/00 (47 poles)	PTC0300
24	
-	-
DFH/2	DH02..
-	-
SDD/1	DD001
SDH/5	DH005
CNU/8/51	NU0851
-	-
SH5/PT	DH501
-	-
CCH/2.5-4	CCH02
-	-
CNU/8/51	NU0851
BTU for PR/DIN and PR/3	BT005
BTO	BT007
BT/3 for PR/3 only	BT003

Type	Cat. No.
HSCB.4/PT/GR	HB101GR
-	-
PTC/5/02 poles	PTC0502
PTC/5/03 poles	PTC0503
PTC/5/05 poles	PTC0505
PTC/5/10 poles	PTC0510
PTC/5/00 (40 poles)	PTC0500
32	
PTC/SP	PTC0990
-	-
DFH/4	DH04..
-	-
SDH/6	DH006
-	-
SH6/PT	DH601
-	-
CCH/2.5-4	CCH02
HSCB/4/CPM	HB405
HSCB/4/PO/2	HB403
HSCB/4/PO/4	HB404
CNU/8/51	NU0851
BTU for PR/DIN and PR/3	BT005
BTO	BT007
BT/3 for PR/3 only	BT003

Type	Cat. No.
HSCB.6/PT/GR	HB201GR
-	-
PTC/8/02 poles	PTC0802
PTC/8/03 poles	PTC0803
PTC/8/05 poles	PTC0805
PTC/8/10 poles	PTC0810
PTC/8/00 (30 poles)	PTC0800
41	
PTC/SP	PTC0990
DFM/500	DF500
-	-
PSD/0	PD017
SDD/1	DD001
-	-
-	-
-	-
CCH/6	CCH06
HSCB/6/CPM	HB205
HSCB/6/PO/2	HB203
HSCB/6/PO/4	HB204
CNU/8/51	NU0851
BTU for PR/DIN and PR/3	BT005
BTO	BT007
BT/3 for PR/3 only	BT003

H Series

- for “blade” fuse according to DIN 72581/3F – ISO 8820 and for Ø 5 x 20 mm fuses (all supplied separately)
- possibility of parallel connection
- mounting onto PR/3 rails conforming to IEC 60715 standard, TH/35 type
- available in the standard version (grey) or in a version appropriate for use with “intrinsically safe” (Exi) circuits (blue), where indicated
- maximum operating temperature 100°C



Please refer to the table on page 131 in order to determine the insulation voltage of the different PTC connection diagrams

(*) value referred to the isolation characteristics of the terminal block



The /GR tag indicates the grey version.

Max. dissipated power - In conf. with IEC 60947-7-3						
Terminal block	Voltage [V]	Current [A]	Protection against overload and short circuit		Only protection against short circuit	
			Single configuration (PV) - [W]	Composite configuration (PV) - [W]	Single configuration (PVK) - [W]	Composite configuration (PVK) - [W]
MPFA.4 + CPF/5	250	6.3	1.6	1.6	4	1.6
DSFA.4 + CPF/5	250	6.3	1.6	1.6	4	1.6
HMFA.2 + CPF/5	250	6.3	1.6	1.6	4	1.6

grey version	
TECHNICAL CHARACTERISTICS	
function/type	
rated cross-section	(mm ²)
connecting capacity	
flexible	(mm ²)
rigid	(mm ²)
max. flexible with ferrule (mm ²) - ferrule type	
rated voltage / rated current / gauge	conf. to IEC 60947-7-1
rated voltage / rated current / AWG	UL
(Ex e) rated voltage	(V)
rated impulse withstand voltage / pollution degree	
insulation stripping length	(mm)
tightening torque value (test / max)	(Nm)
height / width / thickness	TH/35 7.5 mm
height / width / thickness	TH/35 15 mm
height / width / thickness	G32

HMFA.2/GR
Cat. No. **HF300GR**



for blade fuse and component-holder cartridge

2.5
0.2-4
0.2-4
2.5-WP25/14
400 V (*) / 6.3 A / A3
-
4 kV (*) / 3
10
-
41 / 66 / 5.2
49 / 66 / 5.2
- / - / -



CPF/5
Cat. No. **CPF05**

component-holder cartridge

-
-
-
320 V (a) / 6.3 A (a) / A5
-
4 kV / 3
-
(b) / 33 / 6
(b) / 33 / 6
(b) / 33 / 6



The cartridge can contain a spare fuse, instead of the LED signalling circuit.

APPROVALS

ACCESSORIES	
End sections	grey beige blue
Permanent cross connection (intrinsically IPXXB protected once mounted)	
Rated current carrying capacity of jumper	(A)
Jumper with increased pitch	
Multiple common bar	250 mm
Shunting screw and sleeve	
Coloured partition	red, green, white
Cross connection barrier	red
Test plug socket	
Test plug	
Modular test plug	
End section for modular test plug	
Blade-type fuses	In = 2 A
according to DIN 72581/3F ISO 8820	In = 5 A
- max voltage 32 V	In = 7.5 A In = 15 A
Warning element	
Numbering strip	
Screwdriver for activation of the spring	
Marking tag	printed or blank
End bracket	

Type	Cat. No.
HMT.2/1+2/PT/GR	HM511GR
-	
PTC/03/02 poles	PTC0302
PTC/03/03 poles	PTC0303
PTC/03/05 poles	PTC0305
PTC/03/10 poles	PTC0310
PTC/03/00 (47 poles)	PTC0300
24	
-	
DFH/2	DH02..
-	
SDD/1	DD001
SDH/5	DH005
SH5/PT	DH501
F32/2	FN03202
F32/5	FN03205
F32/7	FN03207
F32/15	FN03215
-	
CNU/8/51	NU0851
CCH/2.5-4	CCH02
CNU/8/51	NU0851
BTU for PR/DIN and PR/3	BT005
BTO	BT007
BT/3 for PR/3 only	BT003

ACCESSORIES		Type	Cat. No.
Marking tag	printed or blank	CNU/8/51	NU0851
Conducting element in tin plated brass	Ø 5 x 20 mm	CO/5	VL103
Cartridge / insert with 1 A diode		SFR/11A (with 1 A diode)	SF992
Cartridge / insert with 3 A diode		SFR/13A (with 3 A diode)	SF993

VERSIONS PROVIDED		Type	Cat. No.
With non-polarized LED microcircuit	12 Vdc / Vac	CPF/5L12	CPF512
With non-polarized LED microcircuit	24 Vdc / Vac	CPF/5L24	CPF524
With non-polarized LED microcircuit	48 Vdc / Vac	CPF/5L48	CPF548
With non-polarized LED microcircuit	115 Vdc / Vac	CPF/5L115	CPF511
With non-polarized LED microcircuit	230 Vdc / Vac	CPF/5L230	CPF523
With 1 A diode (1N4001-1N4007 types)		CPF/5D1A	CPF501
With 3 A diode (BY255 type)		CPF/5D3A	CPF503
With resistor 1200 Ω (1 W ± 5%)		CPF/5R	CPR05

When the cartridge is mounted on HMFA 2 terminals, adjoining one another, a terminal strip must be envisaged between one terminal and the next, because of the pitch differential between terminal and cartridge.

Note:

- (a) with fuse ø 5 x 20 mm, 250 V, I_{max} = 6,3 A – with brass pin I_{max} = 10 A
- (b) total value, when the cartridge is mounted on terminals, including the mounting rail

H Series

- mounted onto PR/3 profiles conforming to IEC 60715 standards, TH/35 type
- for \varnothing 5 x 20 mm or \varnothing 6.3 x 32 mm fuses (supplied separately), with possible warning of any broken fuse through LED microcircuit (CIL/...) or [only HFR.4/GR] neon light (LSN)
- available in grey (RAL 7042)
- patented "Easy Bridge" system: double possibility of inserting modular multi-pole cross connections (PTCs), with no need for additional protections
- can be coupled with all HMM.4/... terminal blocks
- maximum operating temperature 100°C

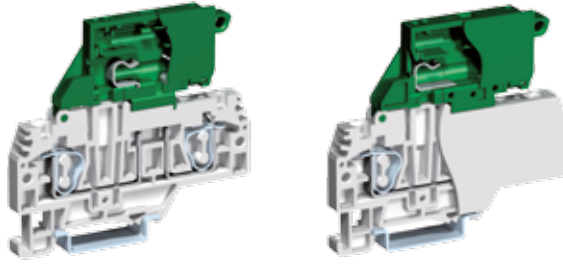

For the isolation figures with cross connections refer to the table on page 131

The /GR tag indicates the grey version.

grey version	
TECHNICAL CHARACTERISTICS	
function/type	
rated cross-section	(mm ²)
connecting capacity	
flexible	(mm ²)
rigid	(mm ²)
max. flexible with ferrule (mm) - ferrule type	
rated voltage / rated current / gauge	conf. to IEC 60947-7-3
rated voltage / rated current / AWG	UL
(Ex e) rated voltage	(V)
rated impulse withstand voltage / pollution degree	
insulation stripping length	(mm)
tightening torque value (test / max)	(Nm)
height / width / thickness	TH/35 7.5 mm
height / width / thickness	TH/35 15 mm
height / width / thickness	G32

APPROVALS

ACCESSORIES	
End sections	grey beige
"Easy Bridge" (PTC) cross connection (intrinsically IPXXB protected once mounted) Available also in coloured version (PTP) Ref. p. 130	
Rated current carrying capacity of jumper	(A)
Cross connection identification strip (100 mm)	
Multiple common bar	250 mm
Shunting screw and sleeve	
Coloured partition	red, green, white
Test plug	
Conductor element	\varnothing 5 x 20 mm
Neon lamp	\varnothing 6 x 26 mm
Warning circuit made up of:	
- 2 contacts	
- 1 microcircuit	
- 1 transparent cover - to be inserted in such a sequence	
Terminal block with 12-48 V non-polarized LED circuit	
Terminal block with 115-230 V non-polarized LED circuit	
Numbering strip	
Screwdriver for activation of the spring	
Marking tag	printed or blank
End bracket	

HFR.4/M/GR	
Cat. No. HF310GR	
<ul style="list-style-type: none"> • for \varnothing 5 x 20 mm fuse 	
4	
0.2-6	
0.2-6	
4-WP40/16	
500 V / 6.3 A (10 A with C0/5) / A4	
-	
-	
4 KV / 3	
12	
-	
70 / 78 / 6.2	
78 / 78 / 6.2	
- / - / -	



HFR.4/GR	
Cat. No. HF210GR	
<ul style="list-style-type: none"> • for \varnothing 6.3 x 32 mm fuse 	
4	
0.2-6	
0.2-6	
4-WP40/16	
500 V / 10 A / A4	
-	
-	
4 KV / 3	
12	
-	
70 / 78 / 8.2	
78 / 78 / 8.2	
- / - / -	



(*): Only for the connection of max. two adjacent terminal blocks

Type	Cat. No.
HFR.4/PT/GR	HF211GR
-	
PTC/5/02 poles	PTC0502
PTC/5/03 poles	PTC0503
PTC/5/05 poles	PTC0505
PTC/5/10 poles	PTC0510
PTC/5/00 (40 poles)	PTC0500
32	
PTC/SP	PTC0990
-	
DFH/4	DH04..
SDD/1	DD001
F5/...	FN...
C0/5	VL103
-	
CIL/HFR/M/12-48	HF518M
CIL/HFR/M/115-230	HF510M
-	
HFR.4/M/GR/C12-48	HF918MGR
HFR.4/M/GR/C115-230	HF910MGR
CNU/8/61	NU0861
CCH/2.5-4	CCH02
CNU/8/51	NU0851
-	
BTU for PR/DIN and PR/3	BT005
BTO	BT007
BT/3 for PR/3 only	BT003

Type	Cat. No.
HFR.4/PT/GR	HF211GR
-	
PTC/51/02 poles	PTC5102
PTC/51/03 poles	PTC5103
PTC/51/05 poles	PTC5105
PTC/51/10 poles	PTC5110
PTC/51/00 (30 poles)	PTC5100
32	
PTC/SP	PTC0990
-	
-	
SDD/1	DD001
-	
-	
LSN	FL202
CIL/HFR/M/12-48	HF518
CIL/HFR/M/115-230	HF510
-	
HFR.4/GR/C12-48	HF918GR
HFR.4/GR/C115-230	HF910GR
-	
CCH/2.5-4	CCH02
-	
-	
BTU for PR/DIN and PR/3	BT005
BTO	BT007
BT/3 for PR/3 only	BT003

H Series

- for female connectors pitch 5.08 mm – on two levels
- mounting onto PR/3-type rails conforming to IEC 60715 standard, TH/35 type
- double possible insertion of the patented “Easy Bridge” multi-polar connection system - PTC cross connection, on each of the two levels
- available in the standard version (grey) or in a version appropriate for use with “intrinsically safe” (Ex)i circuits (blue), where indicated
- maximum operating temperature 100°C



For the isolation figures with cross connections refer to the table on page 131

The /GR tag indicates the grey version.

grey version	
(Ex)i version	
TECHNICAL CHARACTERISTICS	
function/type	
rated cross-section	(mm ²)
connecting capacity	
flexible	(mm ²)
rigid	(mm ²)
max. flexible with ferrule (mm ²) - ferrule type	
rated voltage / rated current / gauge	conf. to IEC 60947-7-1
rated voltage / rated current / AWG	UL
(Ex e) rated voltage	(V)
rated impulse withstand voltage / pollution degree	
insulation stripping length	(mm)
tightening torque value (test / max)	(Nm)
height / width / thickness	TH/35 7.5 mm
height / width / thickness	TH/35 15 mm
height / width / thickness	G32

APPROVALS

HCD.1/GR	Cat. No. HC200GR
HCD.1 (Ex)i	Cat. No. HC210

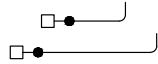

2 level feed-through with 2 screw connections and 2 pins for connectors	1.5
	0.2–2.5
	0.2–2.5
	1.5–WP15/14
	320 V / 12 A / B2
	300 V / 12 A / 26-14 AWG
	-
	6 kV / 3
	10
	-
	59 / 72 / 5.08
	67 / 72 / 5.08
	- / - / -



ACCESSORIES	
End sections	grey beige blue
Permanent cross connection (intrinsically IPXXB protected once mounted)	
Rated current carrying capacity of jumper	(A)
Multiple common bar	250 mm
Shunting screw and sleeve	
Coloured partition	red, green, white
Cross connection barrier	red
Test plug socket	
Test plug	
Modular test plug	
End section for modular test plug	
Protection cover for	10-pole shanks
Numbering strip	
Screwdriver for activation of the spring	
Marking tag	printed or blank
End bracket	

Type	Cat. No.
HCD.1/PT/GR	HC201GR
-	
HCD.1/PT(Ex)i	HC211
PTC/2/02 poles	PTC0202
PTC/2/03 poles	PTC0203
PTC/2/05 poles	PTC0205
PTC/2/10 poles	PTC0210
PTC/2/00 (50 poles)	PTC0200
24	
-	
DFU/7	DU07..
DFM/500	DF500
-	
-	
-	
-	
VPC/VT	VP102
CNU/8/51	NU0851
CCH/2.5-4	CCH02
CNU/8/51	NU0851
BTO	BT007
-	
BT/3 for PR/3 only	BT003

detail of PTC jumper with DFM/500 barriers, CNU/8/51 numbering strips and VPC/VT lug protection covers



detail with 5.08 mm female connectors inserted on the two levels and the lug protection covers raised



Female connectors, 90°–5.08 mm pitch and with a number of poles from 2 to 16, are available. The connector can be easily inserted until it reaches its blocking position, guaranteeing optimum connection onto the male contact. In this position the connector is hooked onto the insulating body with the holding tooth with which it is fitted.

VPC/F02 - 2 poles	Cat. No. VP902
VPC/F03 - 3 poles	Cat. No. VP903
VPC/F04 - 4 poles	Cat. No. VP904
VPC/F05 - 5 poles	Cat. No. VP905
VPC/F06 - 6 poles	Cat. No. VP906
VPC/F07 - 7 poles	Cat. No. VP907
VPC/F08 - 8 poles	Cat. No. VP908
VPC/F09 - 9 poles	Cat. No. VP909
VPC/F10 - 10 poles	Cat. No. VP910
VPC/F11 - 11 poles	Cat. No. VP911
VPC/F12 - 12 poles	Cat. No. VP912
VPC/F13 - 13 poles	Cat. No. VP913
VPC/F14 - 14 poles	Cat. No. VP914
VPC/F15 - 15 poles	Cat. No. VP915
VPC/F16 - 16 poles	Cat. No. VP916

H Series

- spring system with connector plug (patented)
- Easy Bridge cross connection system (patented)
- available in grey
- maximum operating temperature 100°C

For the isolation figures with cross connections refer to the table on page 131

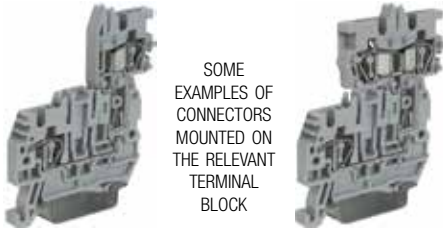

The /GR tag indicates the grey version.

(*) with end plate interposed also on the connector
(**) dimensions with inserted connector

The CHP2/GR and CHP2D/GR connectors are equipped with two integrated polarisers for each pole. The polarisers can be cut with the aid of a simple cutter to enable insertion of the connectors in the specific seats of the HVPC.2/GR terminal blocks

grey version	
(Ex)i version	
TECHNICAL CHARACTERISTICS	
function/type	
rated cross-section	(mm ²)
connecting capacity	
flexible	(mm ²)
rigid	(mm ²)
max. flexible with ferrule (mm ²) - ferrule type	
rated voltage / rated current / gauge	conf. to IEC 60947-7-1
rated voltage / rated current / AWG	UL
(Ex e) rated voltage	(V)
rated impulse withstand voltage / pollution degree	
insulation stripping length	(mm)
tightening torque value (test / max)	(Nm)
height / width / thickness	TH/35 7.5 mm
height / width / thickness	TH/35 15 mm
height / width / thickness	G32

HVPC.2/GR	Cat. No. HVP300GR
HVPC.2 (Ex)i	Cat. No. HVP305

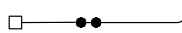

spring type for connectors	2.5
flexible	0.2-4
rigid	0.2-4
max. flexible with ferrule (mm ²) - ferrule type	2.5-WP25/14
rated voltage / rated current / gauge	800 V / 24 A / A3
rated voltage / rated current / AWG	-
(Ex e) rated voltage	-
rated impulse withstand voltage / pollution degree	8 KV / 3
insulation stripping length	10
tightening torque value (test / max)	-
height / width / thickness	41 / 50 / 5.2
height / width / thickness	49 / 50 / 5.2
height / width / thickness	- / - / -



CHP2/GR	Cat. No. HVP900GR
CHP2 (Ex)i	Cat. No. HVP905

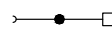

female connector for one conductor	2.5
flexible	0.2-4
rigid	0.2-4
max. flexible with ferrule (mm ²) - ferrule type	2.5-WP25/14
rated voltage / rated current / gauge	500 V / 24 A / A3
rated voltage / rated current / AWG	-
(Ex e) rated voltage	-
rated impulse withstand voltage / pollution degree	8 KV / 3
insulation stripping length	10
tightening torque value (test / max)	-
height / width / thickness	67 (**)/ 58 (**)/ 5.2
height / width / thickness	75 (**)/ 58 (**)/ 5.2
height / width / thickness	-



CHP2D/GR	Cat. No. HVP910GR
CHP2D (Ex)i	Cat. No. HVP915



female connector for two conductors	2.5
flexible	0.2-4
rigid	0.2-4
max. flexible with ferrule (mm ²) - ferrule type	2.5-WP25/14
rated voltage / rated current / gauge	500 V / 24 A / A3
rated voltage / rated current / AWG	-
(Ex e) rated voltage	-
rated impulse withstand voltage / pollution degree	8 KV / 3
insulation stripping length	10
tightening torque value (test / max)	-
height / width / thickness	67 (**)/ 58 (**)/ 5.2
height / width / thickness	75 (**)/ 58 (**)/ 5.2
height / width / thickness	-



APPROVALS

ACCESSORIES

End sections	grey blue
"Easy Bridge" (PTC) cross connection (intrinsically IPXXB protected once mounted) Available also in coloured version (PTP) Ref. p. 130	
Rated current carrying capacity of jumper	(A)
Cross connection identification strip (100 mm)	green
Multiple common bar	250 mm
Shunting screw and sleeve	
Coloured partition	red, green, white
Cross connection barrier	red
Test plug socket	
Test plug	
Modular test plug	
End section for modular test plug	
Protection cover for	10-pole shanks
Numbering strip	
Screwdriver for activation of the spring	
Marking tag	printed or blank
End bracket	

Type	Cat. No.
HVPC.2/PT/GR	HVP301GR
PTC/03/02 poles	PTC0302
PTC/03/03 poles	PTC0303
PTC/03/05 poles	PTC0305
PTC/03/10 poles	PTC0310
PTC/03/00 (47 poles)	PTC0300
24	
PTC/SP	PTC0990
-	
DFH/1	DH01..
-	
SDD/1	DD001
SDH/5	DH005
SH5/PT	DH501
-	
CNU/8/51	NU0851
CCH/2.5-4	CCH02
CNU/8/51	NU0851
BTU for PR/DIN and PR/3	BT005
BTO	BT007
BT/3 for PR/3 only	BT003

Type	Cat. No.
CHP2/PT/GR	HVP901GR
PTC/03/02 poles	PTC0302
PTC/03/03 poles	PTC0303
PTC/03/05 poles	PTC0305
PTC/03/10 poles	PTC0310
PTC/03/00 (47 poles)	PTC0300
24	
PTC/SP	PTC0990
-	
DFH/1	DH01..
-	
SDD/1	DD001
SDH/5	DH005
SH5/PT	DH501
-	
CNU/8/51	NU0851
CCH/2.5-4	CCH02
CNU/8/51	NU0851
-	

Type	Cat. No.
CHP2D/PT/GR	HVP911GR
PTC/03/02 poles	PTC0302
PTC/03/03 poles	PTC0303
PTC/03/05 poles	PTC0305
PTC/03/10 poles	PTC0310
PTC/03/00 (47 poles)	PTC0300
24	
PTC/SP	PTC0990
-	
DFH/1	DH01..
-	
SDD/1	DD001
SDH/5	DH005
SH5/PT	DH501
-	
CNU/8/51	NU0851
CCH/2.5-4	CCH02
CNU/8/51	NU0851
-	

H Series

- spring system with connector plug for earth connections (patented)
- Easy Bridge cross connection system (patented)
- maximum operating temperature 100°C

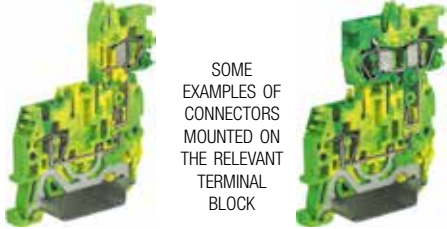

(**) dimensions with inserted connector

yellow/green version

TECHNICAL CHARACTERISTICS

function/type	
rated cross-section	(mm ²)
connecting capacity	
flexible	(mm ²)
rigid	(mm ²)
max. flexible with ferrule (mm ²) - ferrule type	
rated voltage / rated current / gauge	conf. to IEC 60947-7-1
rated voltage / rated current / AWG	UL
(Ex e) rated voltage	(V)
rated impulse withstand voltage / pollution degree	
insulation stripping length	(mm)
tightening torque value (test / max)	(Nm)
height / width / thickness	TH/35 7.5 mm
height / width / thickness	TH/35 15 mm
height / width / thickness	G32

APPROVALS

ACCESSORIES

End sections	green/yellow
Permanent cross connection (intrinsically IPXXB protected once mounted)	
Rated current carrying capacity of jumper	(A)
Multiple common bar	250 mm
Shunting screw and sleeve	
Coloured partition	red, green, white
Cross connection barrier	red
Test plug socket	
Test plug	
Modular test plug	
End section for modular test plug	
Protection cover for	10-pole shanks
Numbering strip	
Screwdriver for activation of the spring	
Marking tag	printed or blank
End bracket	

HVTE.2

Cat. No. HVT500

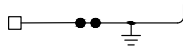

earth spring type for connectors	2.5
0.2-4	
0.2-4	
2.5-WP25/14	
- / - / A3	
- - / - - / 28-12 AWG	
-	
8 KV / 3	
10	
-	
41 / 50 / 5.2	
49 / 50 / 5.2	
- / - / -	



Type	Cat. No.
HVPC.2/PT/GR	HVP301GR
-	
24	
PTC/SP	PTC0990
-	
DFH/1	DH01..
-	
SDD/1	DD001
-	
-	
-	
CNU/8/51	NU0851
CCH/2.5-4	CCH02
CNU/8/51	NU0851
-	
BTU for PR/DIN and PR/3	BT005
BTO	BT007
BT/3 for PR/3 only	BT003

CHTE.2

Cat. No. HVT900

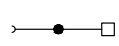

female connector for one conductor	2.5
0.2-4	
0.2-4	
2.5-WP25/14	
- / - / A3	
- - / - - / 28-12 AWG	
-	
8 KV / 3	
10	
-	
67 (**)/ 58 (**)/ 5.2	
75 (**)/ 58 (**)/ 5.2	
-	



Type	Cat. No.
CHP2/PT/GR	HVP301GR
PTC/03/02 poles	PTC0302
PTC/03/03 poles	PTC0303
PTC/03/05 poles	PTC0305
PTC/03/10 poles	PTC0310
PTC/03/00 (47 poles)	PTC0300
24	
PTC/SP	PTC0990
-	
DFH/1	DH01..
-	
SDD/1	DD001
SDH/5	DH005
SH5/PT	DH501
-	
CNU/8/51	NU0851
CCH/2.5-4	CCH02
CNU/8/51	NU0851
-	

CHTE.2D

Cat. No. HVT910

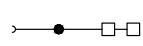

female connector for two conductors	2.5
0.2-4	
0.2-4	
2.5-WP25/14	
- / - / A3	
- - / - - / 28-12 AWG	
-	
8 KV / 3	
10	
-	
67 (**)/ 58 (**)/ 5.2	
75 (**)/ 58 (**)/ 5.2	
-	



Type	Cat. No.
CHP2D/PT/GR	HVP911GR
PTC/03/02 poles	PTC0302
PTC/03/03 poles	PTC0303
PTC/03/05 poles	PTC0305
PTC/03/10 poles	PTC0310
PTC/03/00 (47 poles)	PTC0300
24	
PTC/SP	PTC0990
-	
DFH/1	DH01..
-	
SDD/1	DD001
SDH/5	DH005
SH5/PT	DH501
-	
CNU/8/51	NU0851
CCH/2.5-4	CCH02
CNU/8/51	NU0851
-	

HPP Series

mini spring-clamp terminal blocks

- colour: grey RAL 7035
- UL94V-0
- mounting onto PR/2 rails, TH/15 type
- available in the standard version (grey RAL 7042) or in a version appropriate for use with "intrinsically safe" (Ex i) circuits (blue)
- maximum operating temperature 100°C
- INERIS 16 ATEX 9002U Ex e and I M2 Ex e I Mb II 2G Ex e IIC Gb certificate of operating temperature: -40 – +80 °C
- CoC IECEx INE 16.0032U

Dimensions: HMM, 2/GR

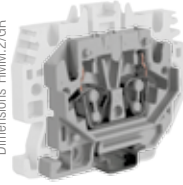

Modular test plug



For the isolation figures with cross connections refer to the table on page 131

The /GR tag indicates the grey version.

standard version	
(Ex) version	
TECHNICAL CHARACTERISTICS	
function/type	
rated cross-section	(mm²)
connecting capacity	
flexible	(mm²)
rigid	(mm²)
max. flexible with ferrule (mm²) - ferrule type	
rated voltage / rated current / gauge	conf. to IEC 60947-7-1
rated voltage / rated current / AWG	UL
(Ex e) rated voltage /	(V)
rated impulse withstand voltage / pollution degree	
insulation stripping length	(mm)
tightening torque value (test / max)	(Nm)
height / width / thickness	TH/15 5,5 mm

APPROVALS

ACCESSORIES	
End sections	grey blue
Permanent cross connection (intrinsically IPXXB protected once mounted)	
Rated current carrying capacity of jumper	(A)
Cross connection identification strip (100 mm)	green
Coloured partition	red, green, white
Numbering strip	
Screwdriver for activation of the spring	
Modular test plug	
End section for modular test plug	
Test plug	
End bracket	

HPP.2/GR	Cat. No.	HP170GR
HPP.2 (Ex)i	Cat. No.	HI132



feed-through	2.5
flexible	0.2-4
rigid	0.2-4
max. flexible with ferrule (mm²) - ferrule type	2.5-WP25/14
rated voltage / rated current / gauge	800 V / 24 A / A3
rated voltage / rated current / AWG	-
(*) rated voltage	
rated impulse withstand voltage / pollution degree	8 KV / 3
insulation stripping length	10
tightening torque value (test / max)	-
height / width / thickness	35 / 36 / 5.2

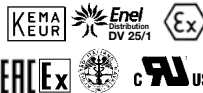

HP.2/GR	Cat. No.	HP150GR
HP.2 (Ex)i	Cat. No.	HI130



feed-through	2.5
flexible	0.2-4
rigid	0.2-4
max. flexible with ferrule (mm²) - ferrule type	2.5-WP25/14
rated voltage / rated current / gauge	800 V / 24 A / A3
rated voltage / rated current / AWG	-
(*) rated voltage	
rated impulse withstand voltage / pollution degree	8 KV / 3
insulation stripping length	10
tightening torque value (test / max)	-
height / width / thickness	30 / 36 / 5.2



Type	Cat. No.
HP/PT/GR	HP101GR
PTC/03/02 poles	PTC0302
PTC/03/03 poles	PTC0303
PTC/03/05 poles	PTC0305
PTC/03/10 poles	PTC0310
PTC/03/00 (47 poles)	PTC0300
24	
PTC/SP	PTC0990
DFP/2	DFP2..
SHZ/2	SH001
CCH/2.5-4	CCH02
SDH/5	DH005
SH5/PT	DH501
SDD/1	DD001
BT/2 for PR/2 only	BT006
-	-
-	-

Type	Cat. No.
HPV/PT/GR	HV111GR
-	-
PTC/03/02 poles	PTC0302
PTC/03/03 poles	PTC0303
PTC/03/05 poles	PTC0305
PTC/03/10 poles	PTC0310
PTC/03/00 (47 poles)	PTC0300
24	
PTC/SP	PTC0990
DFP/2	DFP2..
SHZ/2	SH001
CCH/2.5-4	CCH02
SDH/5	DH005
SH5/PT	DH501
SDD/1	DD001
BT/2 for PR/2 only	BT006
-	-
-	-

In electrical panels where the spaces are particularly limited and in any case when a high wiring density is required, Cabur proposes, also for the connection with spring technology, a series of mini terminal blocks, for conductors up to 4 mm². The range comprises three versions, for panel mounting (fixing with screw or clip) and for mounting on 15 mm PR/2 guide, according to IEC 60715. The particular conformation of the insulating body of the three types of terminal blocks enables snap-in coupling of each of them, including between terminal blocks of different types, in order to ensure the maximum flexibility of use.

SUGGESTED COMPOSITION: for mounting terminal boards made up of **HPP.2/GR** terminal blocks a conformation of the terminal board of four **HP.2/GRs** for every **HPP.2/GR** is recommended. If instead it is necessary to remove the terminal board thus made up from the guide, it is recommended to separate units made up of a **HPP.2/GR** and remove one at a time, with the aid of an opportune screwdriver (CCH/2,5-4), acting in the specific slots.

HPC Series

- UL94V-0
- panel mount by means of clips
- panel thickness 0.6 – 1.2 mm
- fixing hole Ø 3.5 mm
- available in the standard version (grey) or in a version appropriate for use with “intrinsically safe” (Ex)i circuits (blue)
- maximum operating temperature 100°C
- INERIS 16 ATEX 9002U Ex e and I M2 Ex e I Mb II 2G Ex e IIC Gb
certificate of operating temperature: -40 – +80 °C
- CoC IECEx INE 16.0032U



Modular test plug



For the isolation figures with cross connections refer to the table on page 131

The /GR tag indicates the grey version.

standard version	
(Ex) version	
TECHNICAL CHARACTERISTICS	
function/type	
rated cross-section	(mm ²)
connecting capacity	
flexible	(mm ²)
rigid	(mm ²)
max. flexible with ferrule (mm ²) - ferrule type	
rated voltage / rated current / gauge	conf. to IEC 60947-7-1
rated voltage / rated current / AWG	UL
(Ex e) rated voltage /	(V)
rated impulse withstand voltage / pollution degree	
insulation stripping length	(mm)
tightening torque value (test / max)	(Nm)
height / width / thickness	TH/15 5.5 mm

HPC.2/GR	
Cat. No.	HP160GR
HPC.2 (Ex)i	
Cat. No.	HI131

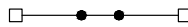

feed-through	
2.5	
0.2-4	
0.2-4	
2.5-WP25/14	
800 V / 24 A / A3	
-	
(*)	
8 KV / 3	
10	
-	
30 / 36 / 5.2	



APPROVALS

ACCESSORIES	
End sections	grey blue
Permanent cross connection (intrinsically IPXXB protected once mounted)	
Rated current carrying capacity of jumper	(A)
Cross connection identification strip (100 mm)	green
Coloured partition	red, green, white
Numbering strip	
Screwdriver for activation of the spring	
Modular test plug	
End section for modular test plug	
Test plug	
End bracket	

Type	Cat. No.
HPV/PT/GR	HV111GR
-	
PTC/03/02 poles	PTC0302
PTC/03/03 poles	PTC0303
PTC/03/05 poles	PTC0305
PTC/03/10 poles	PTC0310
PTC/03/00 (47 poles)	PTC0300
24	
PTC/SP	PTC0990
DFP/2	DH02..
SHZ/2	SH001
CCH/2.5-4	CCH02
SDH/5	DH005
SH5/PT	DH501
SDD/1	DD001
BT/2 for PR/2 only	BT006
-	
-	

In electrical panels where the spaces are particularly limited and in any case when a high wiring density is required, Cabur proposes, also for the connection with spring technology, a w of mini terminal blocks, for conductors up to 4 mm². The range comprises three versions, for panel mounting (fixing with screw or clip) and for mounting on 15 mm PR/2 guide. The particular conformation of the insulating body of the three types of terminal blocks enables snap-in coupling of each of them, including between terminal blocks of different types, in order to ensure the maximum flexibility of use.

Insulation displacement terminal blocks

The **NCS** terminal block represents an optimal solution for the rapid and secure connection of conductors with a small section.

The connection system minimises the wiring times as no preparation of the conductor or action to tighten the screws is necessary.

It is sufficient to cut the conductor and, unlike what happens with the other connection types that need removal of an adequate length of insulation, introduce it into the upper part of the terminal block chamber. At this point the simple action, to be carried out directly with the fingers or with a very normal screwdriver, on the pressure element, determines the passage of the conductor itself through a fork of the conductor body, with consequent displacement of the insulation and creation of the contact. In the operating position the conductor is placed in the lower part of the introduction chamber.

It must be stressed in particular that the connection can be created with no tools or using a very simple tool, a screwdriver, which is normally in the operator's kit.

The metal body, which performs the dual function of connection and current conduction, is made of a special copper alloy and ensures the best resistance to all aggressive agents and, with its elasticity, a high number of manoeuvres (more than 50), guaranteeing always a reliable electrical contact. The particular shape and angle of the fork, used for the displacement of the insulation and the contact, also stops the conductor from accidentally coming out of its seat.

In a way that is just as easy it is possible to remove the conductor from the terminal block: again using a screwdriver (see figure) it is in fact possible to raise the pressure element which, in its lower part, is configured so as to drag the conductor out of the contact fork zone making it free for extraction.

In the case of a new use of the extracted conductor it is sufficient to give the same a new heading and repeat the action described above.

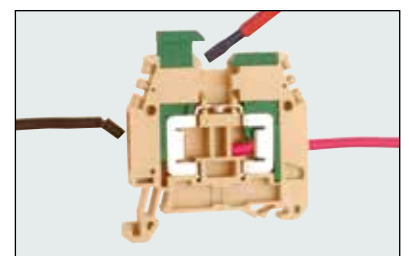
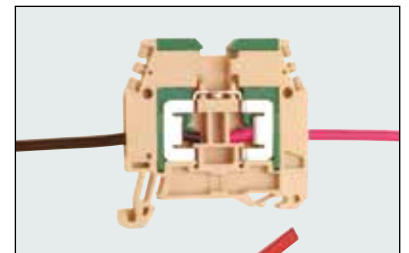
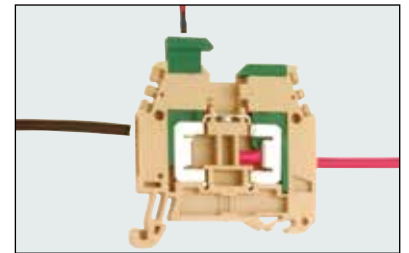

Note:

the terminal block NCS terminal block is joined by the NCV version which provides on one side Insulation Displacement Connection (IDC) and on the other the traditional screw-clamp connection.

This solution can be useful if the needs "in the field" are for a conductor with a larger section (up to 6 mm²) or if it is decided in any case to guarantee to the end user a screw-clamp connection.

NCS/V Series

- UL94V-0
- mounting onto PR/3 rail conforming to IEC 60715 standard, TH/35 type
- maximum operating temperature 100°C



beige version	
(Ex)i version	
TECHNICAL CHARACTERISTICS	
function/type	
rated cross-section	(mm ²)
connecting capacity	
flexible	(mm ²)
rigid	(mm ²)
max. flexible with ferrule (mm ²) - ferrule type	
rated voltage / rated current / gauge	conf. to IEC 60947-7-1
rated voltage / rated current / AWG / tightening torque value	UL
rated impulse withstand voltage / pollution degree	
insulation stripping length	(mm)
height / width / thickness	TH/35 7.5 mm
height / width / thickness	TH/35 15 mm
height / width / thickness	G32

NCS	Cat. No.	NC100
feed-through		
1.5		
0.5-1.5		
0.5-1		
-		
800 V / 15 A / -		
600 V / 15 A / 20-16 AWG		
8 KV / 3		
-		
47 (53 with raised presser) / 48 / 6.2		
55 (61 with raised presser) / 48 / 6.2		
-		

NCV	Cat. No.	NC200
version with 1 screw connection		
4 / 1.5		
0.2-6 / 0.5-1.5		
0.2-6 / 0.5-1		
4-WP40/16 (screw connection side)		
800 V / 15 A / A4		
600 V / 15 A / 20-16 AWG / 8.9 lb.in.		
8 KV / 3		
-		
47 (53 with raised presser) / 48 / 6.2		
55 (61 with raised presser) / 48 / 6.2		
-		

APPROVALS



ACCESSORIES	
End sections	grey beige blue
Permanent cross connection (intrinsically IPXXB protected once mounted)	
Rated current carrying capacity of jumper	(A)
Multiple common bar	250 mm
Shunting screw and sleeve	
Coloured partition	red, green, white
Cross connection barrier	red
Test plug socket	
Test plug	
Numbering strip	
Screwdriver for activation of the spring	
Warning plate	on adjacent terminal blocks
Marking tag	printed or blank
End bracket	

Type	Cat. No.
-	
NCS/PT	NC101
-	
POF/99	POF99
-	
24	
PMP/02	PMP02
CPM/99	CPM99
DFU/02	DU02..
-	
-	
-	
-	
-	
-	
CNU/8/51	NU0851
-	
BTU for PR/DIN and PR/3	BT005
BTO	BT007
BT/3 for PR/3 only	BT003

Type	Cat. No.
-	
NCS/PT	NC101
-	
POF/99	POF99
-	
24	
PMP/02	PMP02
CPM/99	CPM99
DFU/02	DU02..
-	
-	
-	
-	
-	
-	
CNU/8/51	NU0851
-	
BTU for PR/DIN and PR/3	BT005
BTO	BT007
BT/3 for PR/3 only	BT003

Terminal boards for metering panels



Cabur control terminal boards have been developed in order to enable electric power suppliers and users to easily check measuring instruments, without interrupting the current carrying circuits during the verification itself or during the replacement of the instruments.

Each terminal board is composed by an insulating body, carrying the copper zinc alloy terminals to which the ammeter, voltmeter circuits and the devices for disconnect and short circuit operations are connected. Each terminal board is supplied with a transparent cover (of cellulose acetate), provided with appropriate captive screws for the sealing of the assembly.

In two-phase and three-phase terminal boards, the insulating base is built from Kelon (an abbreviation of Ceramic + Nylon): this is a nylon 6 based, self-extinguishing UL94V-0 polymer with the addition of special ceramic spheres and subsequent thermal stability. The inclusion of the microspheres and the thermal procedure make the item extremely hardwearing (rigid, but also able to withstand impacts and wear and tear)

The current phases are marked in different colours, to be defined when ordering.

TECHNICAL CHARACTERISTICS

rated cross-section	6 mm ²
connecting capacity	
flexible conductors	0.5 – 6 mm ²
rigid conductors	0.5–6 mm ²
conductors insertion hole	Ø 4,1 (mm)
tightening torque	1.2 (Nm)
rated current (conf. to IEC 60947-7-1)	57 A
rated voltage (conf. to IEC 60947-7-1)	500 V
rated impulse withstand voltage / pollution degree	6 KV / 3

MCM Series

The use of **MCM** Series control terminal boards allows:

- 1) disconnection, upstream and downstream the measuring instruments
- 2) the insertion of a test instrument, downstream or upstream the measuring instruments
- 3) shunting, by means of common plugs, from the four connection terminals
- 4) voltage transmission from the beginning of the ammeter circuit to the disconnect slide-link by means of a simple cross connections.

In normal service, voltmeter leads are connected to the R-S-T terminals, whilst the ammeter leads, are to be inserted in the terminals identified R1-R2, S1-S2, T1-T2. The instruments are connected to terminals 1 and 2.

The vertical slide-link cross connections are closed, the horizontal slide-link cross connections are open.

When inserting control instruments, the following instructions are to be followed:

- by means of normal plugs, the voltmeter leads must be shunted from the test instrument on to the voltage sockets of the disconnect slide-link or to the insertion blocks of the fuse-holders;
- the ammeter leads of the test instruments must be inserted in sockets 1 ad R1 or 2 ad R2; same procedure is to be followed for the other phases;
- therefore, the corresponding vertical slide-link must be disconnected.

If there is a need to replace a measuring instrument, it is necessary to previously close the horizontal slide-links, disconnect the vertical slide-links and open the slide-link.

Feeding conductors (incoming and outgoing) are inserted from the rear of the terminal board, with conductors passing through slots on the insulating base of the terminal board.

MCM.1 Series

- for meters with single phase insertion
- rear cable input



Overall dimension (with cover)
MCM.1: 95 x 85 x 48 mm

ENEL has adopted a special colour system to identify phases according to the sections where the terminal blocks are installed.
 From the left, phases are identified as follows:

Type	Cat. No.
MCM.1/B (white)	MC201B (adopted in Campania and Lombardy)
MCM.1/G (yellow)	MC201G (adopted in Veneto and Trentino Alto Adige)
MCM.1/R (red)	MC201R (adopted in the rest of Italy)

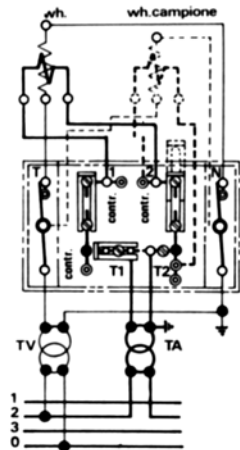

Application scheme

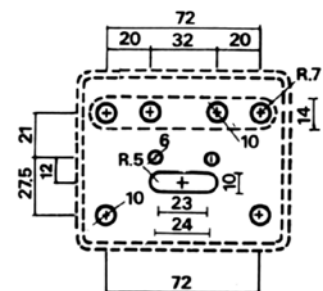

Fixing template

MCM.2 Series

- for meters with ARON insertion
- rear cable input

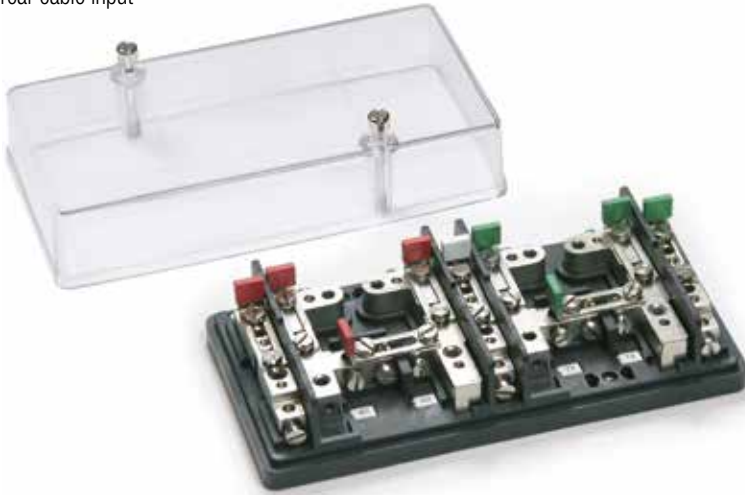

Overall dimension (with cover)
MCM.2: 170 x 85 x 48 mm

ENEL has adopted a special colour system to identify phases according to the sections where the terminal blocks are installed.

From the left, phases are identified as follows:

Type	Cat. No.
MCM.2/B (white)	MC202B (adopted in Campania and Lombardy)
MCM.2/G (yellow)	MC202G (adopted in Veneto and Trentino Alto Adige)
MCM.2/R (red)	MC202R (adopted in the rest of Italy)

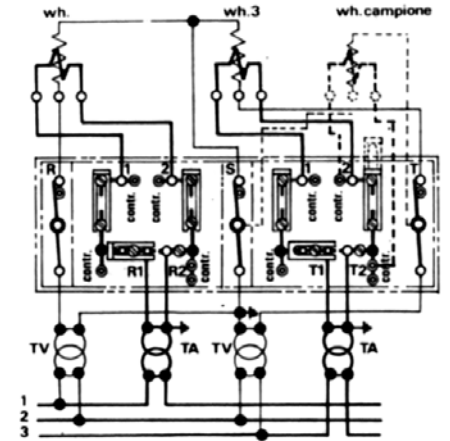

Application scheme

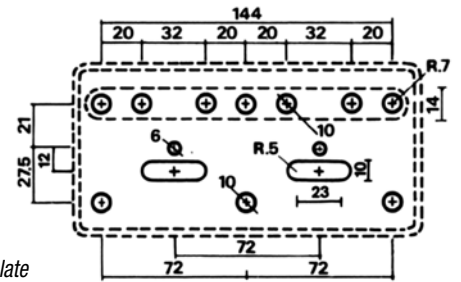

Fixing template

MCM.3 Series

- for meters with three-phase and neutral insertion
- rear cable input



Overall dimension (with cover)
MCM.3: 245 x 85 x 48 mm

ENEL has adopted a special colour system to identify phases according to the sections where the terminal blocks are installed.

From the left, phases are identified as follows:

Type	Cat. No.
MCM.3/B (white)	MC203B (adopted in Campania and Lombardy)
MCM.3/G (yellow)	MC203G (adopted in Veneto and Trentino Alto Adige)
MCM.3/R (red)	MC203R (adopted in the rest of Italy)

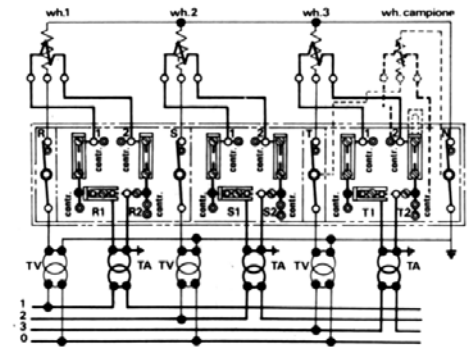

Application scheme

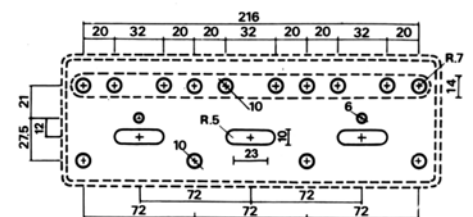

Fixing template

MCM.3/VE Series

- for meters with three-phase and neutral insertion
- rear cable input

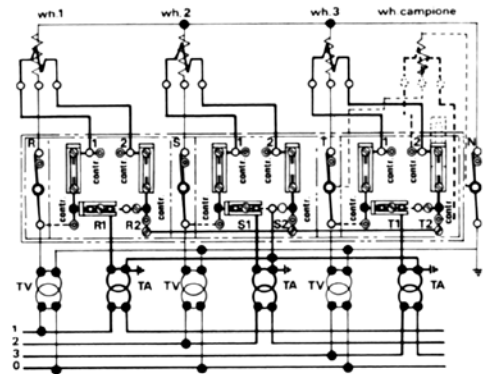

Application scheme

Overall dimension (with cover)
MCM.3/VE: 245 x 85 x 48 mm

ENEL has adopted a special colour system to identify phases according to the sections where the terminal blocks are installed.
 From the left, phases are identified as follows:

Type	Cat. No.
MCM.3/VE/B (white)	MC233B (adopted in Campania and Lombardy)
MCM.3/VE/G (yellow)	MC233G (adopted in Veneto and Trentino Alto Adige)
MCM.3/VE/R (red)	MC233R (adopted in the rest of Italy)

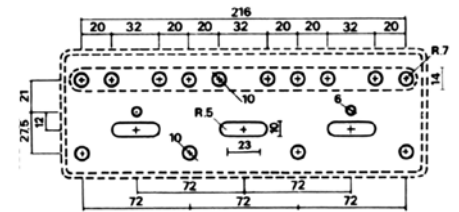

Fixing template

MCT/SA Series

The MCT/SA Series differs from the MCM Series in the following ways:

- 1) both entry and exit of power supplies takes place at the front of the terminal block, with conductors that pass through open slots created on the upper and lower walls of the cover
- 2) there is a door cover with safety blocks which prevent it from closing when the cursors are not in the proper position. Use of the MCT/SA terminal blocks is the same as that of the MCM Series.

MCT/SA Series

- for meters with single phase insertion
- side cable input



Overall dimension (with cover)
MCT.1/SA: 95 x 85 x 48 mm

ENEL has adopted a special colour system to identify phases according to the sections where the terminal blocks are installed.
 From the left, phases are identified as follows:

Type	Cat. No.
MCT.1/SA/B (white)	MC401B (adopted in Campania and Lombardy)
MCT.1/SA/G (yellow)	MC401G (adopted in Veneto and Trentino Alto Adige)
MCT.1/SA/R (red)	MC401R (adopted in the rest of Italy)

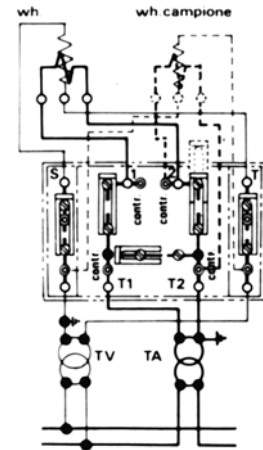

Application scheme

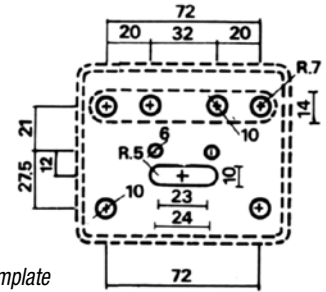

Fixing template

MCT.2/SA Series

- for meters with ARON insertion
- side cable input



Overall dimension (with cover)
MCT.2/SA: 170 x 85 x 48 mm

ENEL has adopted a special colour system to identify phases according to the sections where the terminal blocks are installed.
 From the left, phases are identified as follows:

Type	Cat. No.
MCT.2/SA/B (white)	MC402B (adopted in Campania and Lombardy)
MCT.2/SA/G (yellow)	MC402G (adopted in Veneto and Trentino Alto Adige)
MCT.2/SA/R (red)	MC402R (adopted in the rest of Italy)

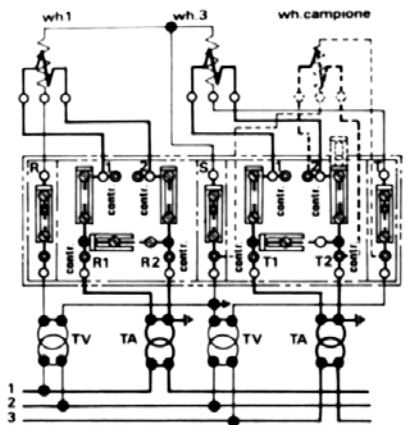

Application scheme

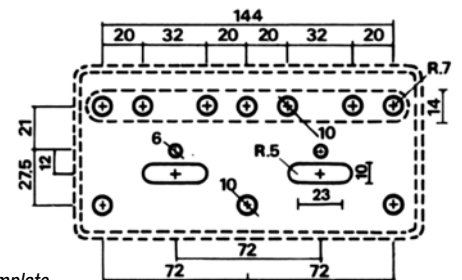

Fixing template

MCT.3/SA Series

- for meters with three-phase and neutral insertion
- side cable input

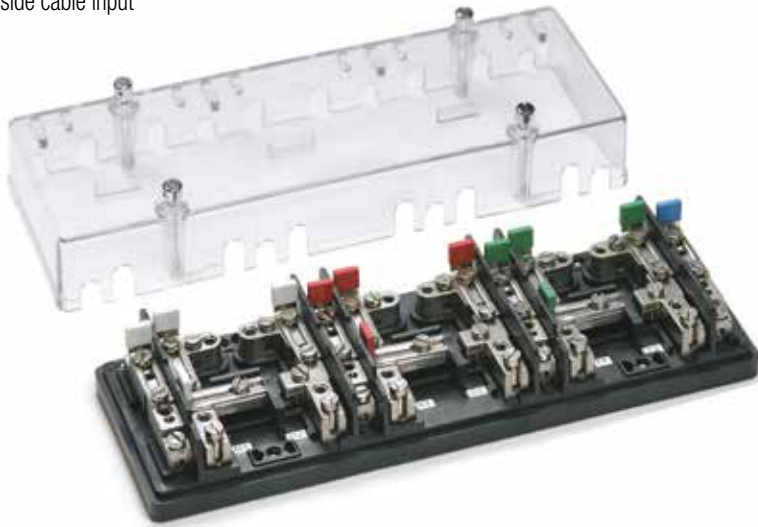

Overall dimension (with cover)
MCT.3/SA: 245 x 85 x 48 mm

ENEL has adopted a special colour system to identify phases according to the sections where the terminal blocks are installed.
 From the left, phases are identified as follows:

Type	Cat. No.
MCT.3/SA/B (white)	MC403B (adopted in Campania and Lombardy)
MCT.3/SA/G (yellow)	MC403G (adopted in Veneto and Trentino Alto Adige)
MCT.3/SA/R (red)	MC403R (adopted in the rest of Italy)

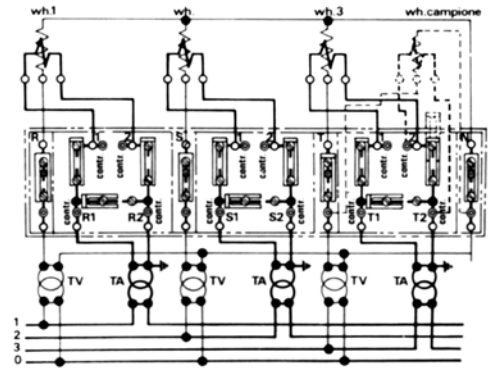

Application scheme

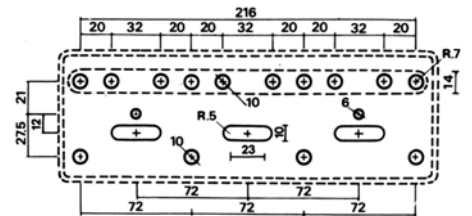

Fixing template

MS.8x10 disconnect terminal board

**8-poles, 4 ammetric
and 4 voltmetric**

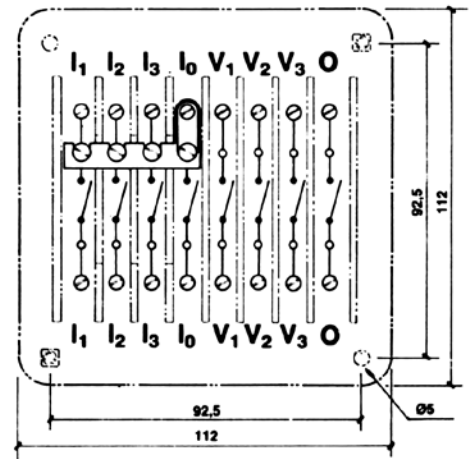

MS/8x10/N

Cat. No.

MZ300N

TECHNICAL CHARACTERISTICS

rated cross-section	10 mm ²
connecting capacity	
flexible conductors	0.5–16 mm ²
conductors insertion hole	5 x 10 (mm)
test tightening torque	120 (Ncm)
rated current (conf. to IEC 60947-7-1)	57 A
rated voltage (conf. to IEC 60947-7-1)	500 V
rated impulse withstand voltage / pollution degree	6 KV / 3
thickness (with cover, including screws)	52 / 65 mm

Insulating body: of green polycarbonate, filled with fibreglass.

Conductor body: components of copper-zinc alloy with high percentage of copper and provided with nickel plating.

Cover: black polyamide

On request, the terminal board can be supplied according to different electrical schemes.

Also available **on request** is a product version, fitted with a transparent cover made of cellulose acetate (for conditions and delivery times, contact the sales office).

Type

Cat. No.

MS/8x10/T

MZ300T



Cat. No. **MZ300N**
(black cover)



Cat. No. **MZ300T**
(transparent cover)

QBLOK Series

Applications

Partition terminal boards are used as supplementary terminal blocks for phase expansion or neutral expansion inside electrical panels.

They are also known as equipotential terminal boards because they are used as equipotential nodes in distribution control units to collect the Earthing system.

General characteristics

- Available in 7 and 12 hole versions
- Mounting onto PR/3 profiles conforming to IEC 60715 standards, TH/35 type
- Inherent protection against accidental contact IPXXB level according to IEC 60529
- Marking possible with a CNU/8 or CNU/10 tag
- Available in green and blue
- Insulating in polyamide 6.6 UL94V-0

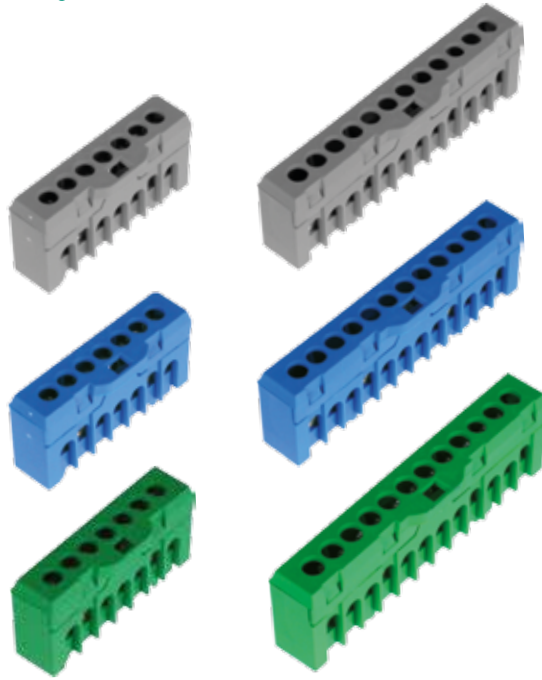

Grey version	QBLOK.7/GR Cat. No. QBLOK7003	QBLOK.12/GR Cat. No. QBLOK1203
Blue version	QBLOK.7/BLU Cat. No. QBLOK7001	QBLOK.12/BLU Cat. No. QBLOK1201
Green version	QBLOK.7/TE Cat. No. QBLOK7002	QBLOK.12/TE Cat. No. QBLOK1202
height / width / thickness TH/35 7.5 mm	33 / 53 / 16	33 / 85 / 16
height / width / thickness TH/35 15 mm	41 / 53 / 16	41 / 85 / 16
TECHNICAL CHARACTERISTICS		
function/type	Distribution terminal boards	Distribution terminal boards
number and diameter of holes	7 holes Ø 5.3 mm	12 holes Ø 5.3 mm
rated cross-section (mm ²)	10	10
connecting capacity		
flexible (mm ²)	1.5–10	1.5–10
rigid (mm ²)	1.5–16	1.5–16
max. flexible with ferrule (mm ²)-ferrule type	10–WP100/21	10–WP100/21
rated voltage / rated current / gauge conf. to IEC 60947-7-	500 V / 63 A / B5	500 V / 63 A / B5
rated impulse withstand voltage / pollution degree	-	-
insulation stripping length (mm)	6	6
tightening torque value (test / max) (Nm)	2 / 2.5 Nm	2 / 2.5 Nm

APPROVALS

ACCESSORIES	Type	Cat. No.	Type	Cat. No.
End section	CNU/8/51	NU0851	CNU/8/51	NU0851
End bracket	BTU for PR/DIN and PR/3 BT/3-BTO for PR/3 only	BT005 BT003-BT007	BTU for PR/DIN and PR/3 BT/3-BTO for PR/3 only	BT005 BT003-BT007
Mounting rail according to IEC 60715 Std.	PR/3/AC of steel PR/3/AS same with slots	PR003 PR005	PR/3/AC of steel PR/3/AS same with slots	PR003 PR005

QBLOK Series

SINGLE POLE DISTRIBUTION TERMINAL BOARDS

Applications

- Easy installation, with dovetail side supports for better compression
- Visible conductor input thanks to an innovative design with a graduated brass body
- Universal power supply: conductor or bar
- High number of connection points
- IPXXB according to IEC60529
- Captive tightening screw
- HF self-extinguishing plastic sleeve
- Mounting onto PR/3 rails conforming to IEC 60715 standards TH/35 type or onto the panel



rated cross-section



mounting



couplings



Cat. No.	QBLOK1P160	QBLOK1P250	QBLOK1P400
Type	QBLOK1P160A6	QBLOK1P250A10	QBLOK1P400A10
Height / width / thickness	TH/35 7.5 mm	68 / 90 / 51	68 / 90 / 51
Height / width / thickness	TH/35 15 mm	75 / 90 / 51	75 / 90 / 51
Number and diameter of holes	1 70mm hole 2 25mm holes 3 16mm holes	1 120mm hole 2 35mm holes 3 25mm holes 4 16mm ² holes	1 185mm ² hole 2 35mm ² holes 3 25mm ² holes 4 16mm ² holes
rated cross-section (mm ²)	70	120	185
Connection capacity of power supply hole 185-120-70 mm² / bar	flexible conductors (mm ²) 10 – 70 rigid conductors (mm ²) 10 – 70 max. flexible conductor with end - end marking (mm) dim power supply bar - l x S (mm) 50 – WP 350/40 15 x 5	35 – 120 35 – 120 - 24 x 10	70 – 185 70 – 185 - 24 x 10
Connection capacity of power supply hole 35 mm²	flexible conductors (mm ²) - rigid conductors (mm ²) - max. flexible conductor with end - end marking (mm) -	4 – 35 4 – 35 25 – WP 250/29	4 – 35 4 – 35 50 – WP 250/29
Connection capacity of power supply hole 25 mm²	flexible conductors (mm ²) 2.5 – 25 rigid conductors (mm ²) 2.5 – 25 max. flexible conductor with end - end marking (mm) 16 – WP 160/22	2.5 – 25 2.5 – 25 16 – WP 160/22	2.5 – 25 2.5 – 25 16 – WP 160/22
Connection capacity of power supply hole 16 mm²	flexible conductors (mm ²) 2.5 – 16 rigid conductors (mm ²) 2.5 – 16 max. flexible conductor with end - end marking (mm) 16 – WP 100/21	1.5 – 16 1.5 – 16 16 – WP 100/21	1.5 – 16 1.5 – 16 16 – WP 100/21
Nominal voltage / nominal current / gauge	690V / 160A / --	690V / 250A / --	690V / 400A / --
Short term current allowed (I _{cw}) (value effective for 1s)	KA -	-	-
Peak current (I _{CC})	KA 8.4	14.4	22.4
Rated impulse withstand voltage / degree of pollution	8kV / 3	8kV / 3	8kV / 3
Insulation stripping length	mm 17 / 12 / 12 10 (70mm ²)	27 / 18 / 12 19 (120mm ²)	27 / 18 / 12 19 (185mm ²)
Tightening torque	Nm 3 (25 and 16 mm ²)	6 (35mm ²) 3 (25 and 16 mm ²)	6 (35mm ²) 3 (25 and 16 mm ²)
Quantity per pack	1	1	1

QBLOK Series

BIPOLAR DISTRIBUTION TERMINAL BOARD

- Easy installation
- Insulating screen for each conducting busbar
- Power supply holes intentionally offset to simplify wiring
- Conforming to EN 60947-1
- Zinc-plated steel screws with combined single-slot
- Transparent polycarbonate, self-extinguishing
- Mounting onto PR/3 rails conforming to IEC 60715 standards TH/35 type or onto the panel



Cat. No.		QBLOK2100	QBLOK2125	QBLOK2126
Type		QBLOK2P100A7	QBLOK2P125A11	QBLOK2P125A15
Height / width / thickness	TH/35 7.5 mm	52 / 49 / 72	52 / 49 / 109	52 / 49 / 137
Height / width / thickness	TH/35 15 mm	59 / 49 / 72	59 / 49 / 109	59 / 49 / 137
number and diameter of holes		2 7.5 mm holes 5 5.4 mm holes	2 9 mm holes 2 7.5 mm holes 7 5.4 mm holes	2 9 mm holes 2 7.5 mm holes 11 5.4 mm holes
rated cross-section	(mm ²)	25	35	35
Connecting capacity of power supply hole 9 mm	flexible (mm ²)	-	10-35	10-35
	rigid (mm ²)	-	10-35	10-35
	max. flexible with ferrule - ferrule type (mm)	-	25-WP 250/29	25-WP 250/29
Connecting capacity of power supply hole 7.5 mm	flexible (mm ²)	10-25	10-25	10-25
	rigid (mm ²)	10-25	10-25	10-25
	max. flexible with ferrule - ferrule type (mm)	16-WP 160/22	16-WP 160/22	16-WP 160/22
Connecting capacity of power supply hole 5.4 mm	flexible (mm ²)	2.5 - 6	2.5 - 6	2.5 - 6
	rigid (mm ²)	2.5 - 6	2.5 - 6	2.5 - 6
	max. flexible with ferrule - ferrule type (mm)	4-WP 40/16	4-WP 40/16	4-WP 40/16
Rated voltage / rated current / gauge		1,000V / 100A /- conf. to EN 60947-1	1,000V / 125A /- conf. to EN 60947-1	1,000V / 125A /- conf. to EN 60947-1
Short-time withstand current (I _{cw}) (r.m.s value x 1s)	KA	3 kA- according to EN 60947-1	3 kA- according to EN 60947-1	3 kA- according to EN 60947-1
Peak current (I _{CC})	KA	x kA according to EN 60947-1	x kA according to EN 60947-1	x kA according to EN 60947-1
rated impulse withstand voltage / pollution degree		8kV / 3	8kV / 3	8kV / 3
Insulation stripping length	mm	13	13	13
Tightening torque	Nm	2 / 2.5	2 / 2.5	2 / 2.5
Quantity per package		4	2	2
Marking tag		NU0851	NU0851	NU0851
End bracket		BT007-BT003-BT005	BT007-BT003-BT005	BT007-BT003-BT005

QBLOK Series

FOUR-POLE DISTRIBUTION TERMINAL BOARDS

- Easy installation
- Insulating screen for each conducting busbar
- Power supply holes intentionally offset to simplify wiring
- Conforming to EN 60947-7-1
- Zinc-plated steel screws with combined single-slot
- Transparent polycarbonate, self-extinguishing
- Mounting onto PR/3 rails conforming to IEC 60715 standards TH/35 type or onto the panel



Cat. No.		QBLOK4100	QBLOK4125	QBLOK4126
Type		QBLOK4P100A7	QBLOK4P125A11	QBLOK4P125A15
Height / width / thickness	TH/35 7.5 mm	52 / 97 / 72	52 / 97 / 108	52 / 97 / 137
Height / width / thickness	TH/35 15 mm	59 / 97 / 72	59 / 97 / 108	59 / 97 / 137
number and diameter of holes		2 7.5 mm holes 5 5.4 mm holes	2 9 mm holes 2 7.5 mm holes 7 5.4 mm holes	2 9 mm holes 2 7.5 mm holes 11 5.4 mm holes
rated cross-section	(mm ²)	25	35	35
Connecting capacity of power supply hole 9 mm	flexible (mm ²)	-	10-35	10-35
	rigid (mm ²)	-	10-35	10-35
	max. flexible with ferrule - ferrule type (mm)	-	25-WP 250/29	25-WP 250/29
Connecting capacity of power supply hole 7.5 mm	flexible (mm ²)	10-25	10-25	10-25
	rigid (mm ²)	10-25	10-25	10-25
	max. flexible with ferrule - ferrule type (mm)	16-WP 160/22	16-WP 160/22	16-WP 160/22
Connecting capacity of power supply hole 5.4 mm	flexible (mm ²)	2.5 - 6	2.5 - 6	2.5 - 6
	rigid (mm ²)	2.5 - 6	2.5 - 6	2.5 - 6
	max. flexible with ferrule - ferrule type (mm)	4-WP 40/16	4-WP 40/16	4-WP 40/16
Rated voltage / rated current / gauge		500V / 100A / -	500V / 125A / -	500V / 125A / -
Short-time withstand current (I _{cw}) (r.m.s value x 1s)	KA	3 according to EN 60947-1	3 according to EN 60947-1	3 according to EN 60947-1
Peak current (I _{CC})	KA	x according to EN 60947-1	x according to EN 60947-1	x according to EN 60947-1
rated impulse withstand voltage / pollution degree		8kV / 3	8kV / 3	8kV / 3
Insulation stripping length	mm	13	13	13
Tightening torque	Nm	2 / 2.5	2 / 2.5	2 / 2.5
Quantity per package		2	1	1
Marking tag		NU0851	NU0851	NU0851
End bracket		BT007-BT003-BT005	BT007-BT003-BT005	BT007-BT003-BT005

QBLOK Series

FOUR-POLE DISTRIBUTION TERMINAL BOARDS

- Easy installation
- Insulating screen for each conducting busbar
- Power supply holes intentionally offset to simplify wiring
- Conforming to EN 60947-7-1
- Zinc-plated steel screws with combined single-slot
- Transparent polycarbonate, self-extinguishing
- Mounting onto PR/3 rails conforming to IEC 60715 standards TH/35 type or onto the panel



Cat. No.		QBLOK4160S	QBLOK4161N
Type		QBLOK4P160A9	QBLOK4P160A14
Height / width / thickness	TH/35 7.5 mm	54 / 99 / 131	54 / 99 / 181
Height / width / thickness	TH/35 15 mm	61 / 99 / 131	61 / 99 / 181
number and diameter of holes		1 11 mm hole 2 8.5 mm holes 6 6.5 mm holes	1 11 mm hole 4 8.5 mm holes 9 6.5 mm holes
rated cross-section	(mm ²)	50	50
Connecting capacity of power supply hole 9 mm	flexible (mm ²) rigid (mm ²) max. flexible with ferrule - ferrule type (mm)	10 - 50 10 - 50 -	10 - 50 10 - 50 35-WP 350/30
Connecting capacity of power supply hole 7.5 mm	flexible (mm ²) rigid (mm ²) max. flexible with ferrule - ferrule type (mm)	10-35 10-35 25-WP 250/29	10-35 10-35 25-WP 250/29
Connecting capacity of power supply hole 5.4 mm	flexible (mm ²) rigid (mm ²) max. flexible with ferrule - ferrule type (mm)	2.5-16 2.5-16 16-WP 160/22	2.5-16 2.5-16 16-WP 160/22
Rated voltage / rated current / gauge		500V / 160A / -	500V / 160A / -
Short-time withstand current (I _{cw}) (r.m.s value x 1s)	KA	6 according to EN 60947-1	6 according to EN 60947-1
Peak current (I _{CC})	KA	x according to EN 60947-1	x according to EN 60947-1
rated impulse withstand voltage / pollution degree		8kV / 3	8kV / 3
Insulation stripping length	mm	13	13
Tightening torque	Nm	2 / 2.5	2 / 2.5
Quantity per package		1	1
Marking tag		NU0851	NU0851
End bracket		BT007-BT003-BT005	BT007-BT003-BT005

POLM Series

Applications

Partition terminal boards are used as supplementary terminal blocks for phase expansion or neutral expansion inside electrical panels.

They are also known as equipotential terminal boards because they are used as equipotential nodes in distribution control units to collect the Earthing system.

General characteristics

- Protected terminal blocks, 7, 11, or 15 holes
- Mounting on mounting rails PR/3 according to IEC 60715, TH/35 type or with screws on walls
- Insulation voltage 500 V (according to IEC 60947-1)
- Conformity with EU Low Voltage Directive 2006/95/EC

Materials

- CW 614N Brass, polyamide (coloured products), polycarbonate (transparent products)
- Zinc-plated steel screws with combined single-slot

Cat. No.	Type	Colour	rated cross-section (mm ²)	Rated current	Number of holes
QPOL1203	POLM.1215	Grey	12 x 1.5 2 x 2.5 1 x 16	80 A	The hole with diameter 16 mm ² has screw clamp
QPOL1205	POLM.1215/BLU	Blue	12 x 1.5 2 x 2.5 1 x 16	80 A	The hole with diameter 16 mm ² has screw clamp
QPOL1204	POLM.1215/TE	Green	12 x 1.5 2 x 2.5 1 x 16	80 A	The hole with diameter 16 mm ² has screw clamp



CONTC Series



Applications

CONTC Series terminal blocks are mainly used inside of junction boxes and, from a physical point of view, can be seen as simple Kirchhoff's nodes.

General characteristics

- Maximum withstand temperature 130 °C
- IP 20 protection degree
- High dielectric strength
- Resistance to tracking currents
- Screw-clamp

Materials

- Products comply with the essential requirements of the BT Directive
- CW 614N Brass
- Zinc-plated screws and dowels
- Transparent polycarbonate

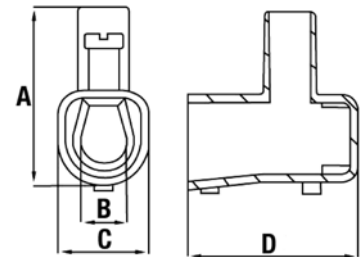

CAT. NO.	TYPE	QUANTITY PER PACKAGE	RATED CROSS-SECTION (mm ²)	RATED CURRENT	RIGID OR FLEXIBLE CONDUCTORS		RATED VOLTAGE	SCREW CLAMP	DIMENSIONS (mm)			
					CONDUCTOR CROSS-SECTION (mm ²)	CONDUCTORS NO.			NUMBER OF POLES	A	B	C
CONTC01	CONT/1.5	10	1.5	17.5A	1.5	2	450V	10	16.0	3.3	10.0	15.0
					1.0	2-3						
					0.75	2-4						
CONTC02	CONT/2.5	10	2.5	24A	2.5	2	450V	10	17.6	3.7	8.4	17.6
					1.5	2-3						
					1.0	2-4						
CONTC04	CONT/4	10	4.0	32A	4.0	2	450V	10	21.0	4.5	10.5	21.0
					2.5	2-3						
					1.5	2-4						
CONTC06	CONT/6	10	6.0	41A	6.0	2	750V	10	23.0	5.6	11.5	22.5
					4.0	2-3						
					2.5	2-4						
CONTC10	CONT/10	5	10.0	57A	10.0	2	750V	10	28.0	6.9	14.6	26.0
					6.0	2-3						
					4.0	2-4						
CONTC16	CONT/16	5	16.0	76A	16.0	2	750V	10	33.0	9.0	19.7	31.0
					10.0	2-3						
					6.0	2-4						
CONTC25	CONT/25	5	25.0	101A	25.0	2	750V	1	39.0	12.0	22.0	38.0
					16.0	2-3						
					10.0	2-4						
CONTC35	CONT/35	5	35.0	125A	35.0	2	750V	1	46.0	14.0	25.0	44.0
					25.0	2-3						
					16.0	2-4						

CONT Series

Double and multiple terminal blocks for derivation boxes from 1.5 to 35mm²

Applications

CONTC Series terminal blocks are mainly used inside of junction boxes and, from a physical point of view, can be seen as simple Kirchhoff's nodes.

Characteristics of the materials

Insulating material:

- Transparent polycarbonate, self-extinguishing UL94-V0
- High mechanical and shock resistance also at low temperatures (-25 °C)
- Maximum withstand temperature 130 °C
- Resistance to flames and to ignition according to IEC 695-2-1
- 850 °C in the incandescent wire test
- High dimensional stability
- Excellent resistance to creeping currents
- High dielectric strength
- Excellent resistance to chemical and atmospheric agents.

Contact material:

- CW 614N Brass
- Galvanised steel screws or grub screws

CONFORMING TO STANDARDS

EN 60998-1, EN 60998-2-1

APPROVALS



DOUBLE MOBILE TERMINAL BLOCKS

The range expands with the new 1.5 mm² terminal block

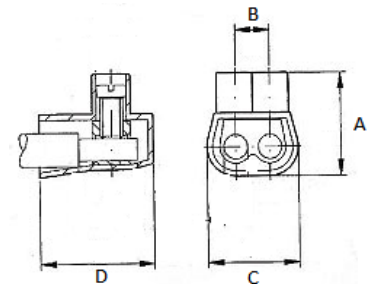

CAT. NO.	RATED SIZE	RATED CURRENT [A]	CABLE USE TABLE STANDARDS IEC 23-20 IEC 23-21			VOLTAGE [V]	STANDARD PACK QUANTITY	SIZE [MM]			
			SECTION CONDUCTORS [MM ²]	N° OF CONDUCTORS CONNECTABLE				A	B	C	D
				RIGID WIRES	FLEXIBLE WIRES						
CONT201	2x1.5mm ²	17.5	1.5	1	1	450	200 20	13	4.5	12	15
			1	1-2	1-2						
			0.75	1-3	1-3						
CONT206	2x6mm ²	41	6	1	-	450	200 20	17	6	15	18
			4	1-2	1						
			2.5	1-3	1-2						
			1.5	-	1-3						
CONT216	2x16mm ²	76	16	1	-	500	100 10	26	8	20	22.5
			10	1-2	1						
			6	1-3	1-2						
			4	-	1-3						
CONT225	2x25mm ²	101	25	1	-	500	100 10	24.5	10	25	26
			16	1-2	1						
			10	1-3	1-2						
			6	-	1-3						
CONT235	2x35mm ²	125	35	1	-	500	50 5	33	13	31.5	31
			25	1-2	1						
			16	1-3	1-2						
			10	-	1-3						

TRIPLE MOBILE TERMINAL BLOCKS

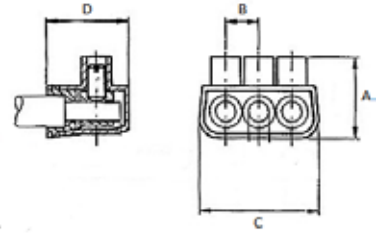

CAT. NO.	RATED SIZE	RATED CURRENT [A]	CABLE USE TABLE STANDARDS IEC 23-20 IEC 23-21			VOLTAGE [V]	STANDARD PACK QUANTITY	SIZE [MM]			
			SECTION CONDUCTORS [MM ²]	N° OF CONDUCTORS CONNECTABLE				A	B	C	D
				RIGID WIRES	FLEXIBLE WIRES						
CONT306	3x6mm ²	41	6	1	-	450	150 15	15.25	5	19.5	14
			4	1	1						
			2.5	1	1						
			1.5	-	1						
CONT316	3x16mm ²	76	16	1	-	450	100 10	22	9	32.5	22.25
			10	1	1						
			6	1	1						
			4	-	1						

MULTIPLE 4-POLE MOBILE TERMINAL BLOCKS

The range is completed with the new 4-pole terminal blocks

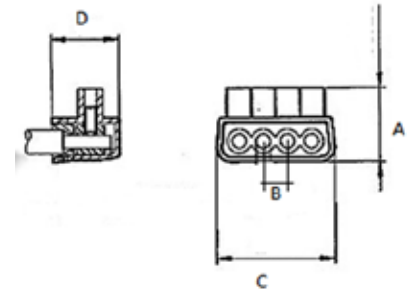

CAT. NO.	RATED SIZE	RATED CURRENT [A]	CABLE USE TABLE STANDARDS CEI 23-20 CEI 23-21			VOLTAGE [V]	STANDARD PACK QUANTITY	SIZE [MM]			
			SECTION CONDUCTORS [MM ²]	N° OF CONDUCTORS CONNECTABLE				A	B	C	D
				RIGID WIRES	FLEXIBLE WIRES						
CONT406	4x6mm ²	41	6	1	-	450	150 15	15.25	5	24.5	14
			4	1	1						
			2.5	1	1						
			1.5	-	1						
CONT416	4x16mm ²	76	16	1	-	450	100 10	22	9	41.5	22.25
			10	1	1						
			6	1	1						
			4	-	1						

MULTIPLE 6-POLE MOBILE TERMINAL BLOCKS

The new CONT606s and CONT616s make it possible to have an additional connection compared to the CONT506s and CONT516s

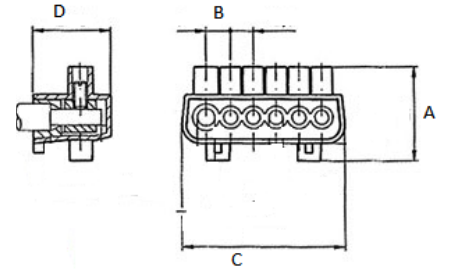
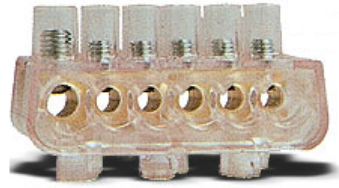

CAT. NO.	RATED SIZE	RATED CURRENT [A]	CABLE USE TABLE STANDARDS IEC 23-20 IEC 23-21			VOLTAGE [V]	STANDARD PACK QUANTITY	SIZE [MM]			
			SECTION CONDUCTORS [MM ²]	N° OF CONDUCTORS CONNECTABLE				A	B	C	D
				RIGID WIRES	FLEXIBLE WIRES						
CONT606	5x6mm ²	41	6	1	-	450	50 5	27	7-6.5	46.5	22.5
			4	1	1						
	2.5		1-2	1							
	10		1	-							
	1x10mm ²		6	1-2	1						
4		1-4	1-3								
CONT616	5x16mm ²	76	16	1	-	500	50 5	30	10-9	62	25.25
			10	1	1						
	6		1	1							
	25		1	-							
	1x25mm ²		16	1	1						
			10	1	1						

CAMUT Series

12-pole terminal strips

General features

- Maximum withstand temperature: 105 °C
- Neutral colour

Materials used

- Brass
- Polyamide PA6
- Passivated steel screws

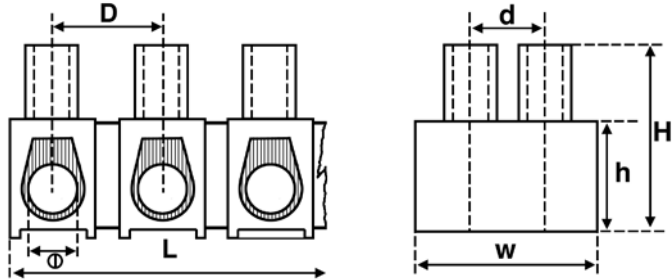

CAT. NO.	TYPE	NOMINAL CURRENT	SECTION (mm ²)	GAUGE	DIMENSIONS (mm)						
					L	W	Ø	D	d	H	h
Cat. No. CAMUT02	CAMUT.12/02	3A	2.5	A3	93.0	17.0	2.8	8.0	6.0	13.7	8.0
Cat. No. CAMUT04	CAMUT.12/04	5A	4.0	A3	117.0	19.0	3.3	9.8	6.5	15.9	9.0
Cat. No. CAMUT06	CAMUT.12/06	10A	6.0	A4	132.0	21.0	4.2	11.0	7.8	16.8	10.0
Cat. No. CAMUT10	CAMUT.12/10	15A	10.0	A5	141.0	23.0	4.5	11.7	8.5	19.0	10.8
Cat. No. CAMUT16	CAMUT.12/16	30A	16.0	B6	168.0	26.0	5.5	14.5	9.5	20.4	12.0
Cat. No. CAMUT25*	CAMUT.12/25	60A	25.0	B6	191.0	29.7	6.6	16.5	11.0	25.9	15.5

Screwdrivers and pliers

Screwdrivers for the activation of the spring on **H** Series terminal blocks



CCH/2,5-4

Cat. No. **CCH02**

blade 0.5 x 3 x 80 mm
length 160 mm

CCH/6

Cat. No. **CCH06**

blade 1 x 5.5 x 125 mm
length 220 mm

Screwdrivers insulated for voltages up to 1000 V



CCV/2.5

Cat. No. **CCV03**

blade 0.4 x 2.5 x 75 mm
length 160 mm

CCV/4

Cat. No. **CCV04**

blade 0.8 x 4 x 100 mm
length 195 mm

CCV/5

Cat. No. **CCV05**

blade 1 x 5.5 x 125 mm
length 220 mm

The ergonomic shape of the handle guarantees comfort during all types of use. Furthermore, each handle has slip-proof rubber inserts to ensure a good grip on the tool.



Crimper



This tool has been designed for plant engineering. The parallel movement of the matrices generates a 10000 N force. The entire tool is coated with plastic, which makes it ergonomic and comfortable to use.

Type	Cat. No.	Description
UMCT	UMCT3149	Crimper
UMPU02510	UMCT3127	Matrix for ferrules from 0.25 to 10 mm ²
UMPU1625	UMCT3153	Matrix for ferrules from 16 to 25 mm ²
UMPU3550	UMCT3154	Matrix for ferrules from 35 to 50 mm ²
UMPI1525	UMCT3129	Matrix for eyelets and spade lugs from 1.5 to 2.5 mm ²
UMPI4060	UMCT3128	Matrix for eyelets and spade lugs from 4 to 6 mm ²

Ferrules



WP ferrules with insulated collar - WP Series

For cable termination, a complete range of single entry bootlace ferrules is available. In electrolytic tinned copper, with polypropylene insulation.

TYPE	CAT. NO.	COLOUR	CROSS-SECTION (mm ²)	D1 (mm)	D2 (mm)	L1 (mm)	L2 (mm)	S1 (mm)	S2 (mm)	PCS per pack
WP5-14	WP30002	White	0.5	1.0	2.6	14.0	8.0	0.15	0.25	500
WP75-14	WP30005	Grey	0.75	1.2	2.8	14.0	8.0	0.15	0.25	500
WP1-14	WP30009	Red	1.0	1.4	3.0	14.0	8.0	0.15	0.25	500
WP15-14	WP30013	Black	1.5	1.7	3.5	14.0	8.0	0.15	0.25	500
WP25-14	WP30016	Blue	2.5	2.2	4.2	14.0	8.0	0.15	0.25	500
WP40-16	WP30019	Grey	4.0	2.8	4.8	17.0	10.0	0.2	0.3	500
WP60-20	WP30022	Yellow	6.0	3.5	6.3	20.0	12.0	0.2	0.3	100
WP100-21	WP30024	Red	10.0	4.5	7.6	22.0	12.0	0.2	0.4	100
WP160-22	WP30026	Blue	16.0	5.8	8.8	24.0	12.0	0.2	0.4	100
WP250-29	WP30028	Yellow	25.0	7.3	11.2	30.0	16.0	0.2	0.4	50
WP350-30	WP30030	Red	35.0	8.3	12.7	30.0	16.0	0.2	0.4	50
WP500-40	WP30032	Blue	50.0	10.3	15.0	36.0	20.0	0.3	0.5	50

Reference drawing

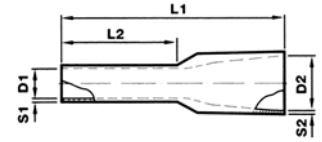

WPD ferrules with insulated collar – double entry

Double entry ferrules are made of electrolytic tinned copper and insulation in special polyamide for high temperatures (+ 110 °C).

These ferrules are designed to be used in connections requiring safe and rapid shunting; indeed, current tendencies towards the miniaturisation of electrical circuits provide a valid and economic use for these terminals.

The unique and large entry space comfortably takes the width of two wires.

Reference drawing

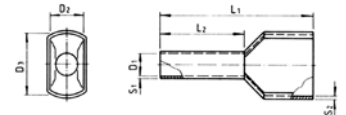

TYPE	CAT. NO.	COLOUR	CROSS-SECTION (mm ²)	DIMENSIONS (mm)						PCS per pack	
				D1	D2	D3	L1	L2	S1		S2
WPD05/15	WP90001	White	2.0 x 0.5	1.5	2.5	4.7	15.7	8.7	0.15	0.3	500
WPD75/15	WP90002	Grey	2.0 x 0.75	1.8	2.8	5.0	15.5	8.9	0.15	0.3	500
WPD01/15	WP90003	Red	2.0 x 1.0	2.3	3.2	5.5	15.8	8.0	0.15	0.3	500
WPD15/16	WP90004	Black	2.0 x 1.5	2.3	3.5	6.5	16.0	8.0	0.15	0.3	500
WPD25/18	WP90005	Blue	2.0 x 2.5	2.9	4.3	7.5	18.3	10.0	0.20	0.4	500
WPD04/23	WP90006	Grey	2.0 x 4.0	3.8	4.9	8.8	23.3	12.5	0.20	0.4	100



TSA cable bindings

For the rapid wiring of conductors; in self-extinguishing polyamide, available in the following sizes:

TSA/3	int. Ø = 1.5 mm - ext. Ø = 3.5 mm	Cat. No. TSA03
TSA/6	int. Ø = 4 mm - ext. Ø = 6 mm	Cat. No. TSA06
TSA/10	int. Ø = 8 mm - ext. Ø = 10 mm	Cat. No. TSA10
TSA/12	int. Ø = 9.5 mm - ext. Ø = 12 mm	Cat. No. TSA12

Accessories

Descriptive illustrations	pages 116-117
End sections	page 118
End brackets	page 119
Tag holder supports	page 120
Mounting rails	pages 121-122
Inclined brackets	pages 123-124
Flat brackets	page 125
Copper busbar blocking terminals and accessories	page 126
Pre-assembled cross connections	page 127
Cross connections - "Easy Bridge" system - PTC Series	pages 128-129
Easy Bridge Plus cross connection	page 130
Easy Bridge & Easy Bridge Plus	page 131
Cross connections - HMD - FDP Series	page 132
Permanent cross connections - POF Series	page 133
Commoning bars, shunting screws and sleeves	page 134
Switchable cross connections	page 135
Modular test plugs	page 136
Test plugs and sockets	page 137
Fuses and signal accessories	page 138
DFU-DFH-DFP partitions	page 139
DFM cross-connection partitions and protection covers	page 140
PZM covers, PZD supports and PRP protection covers	page 141
Warning plates and MSM handle	page 142
Tag holder	page 143
<i>Speed Rail</i>	pages 144-145
Marking systems – Marking Pro	pages 146-147
Marking systems – Numbering strips	pages 148-150
Specific accessories	page 151

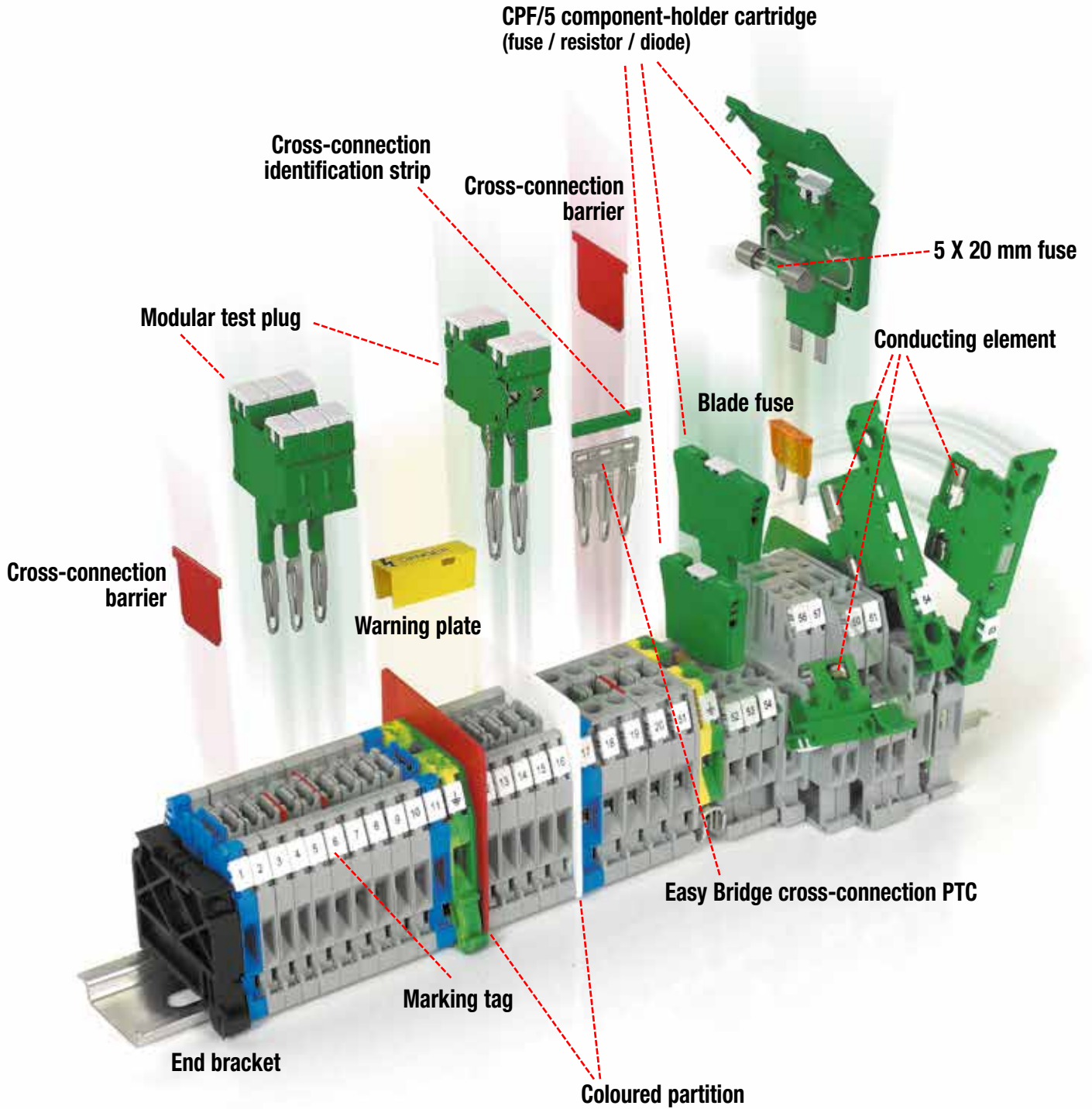

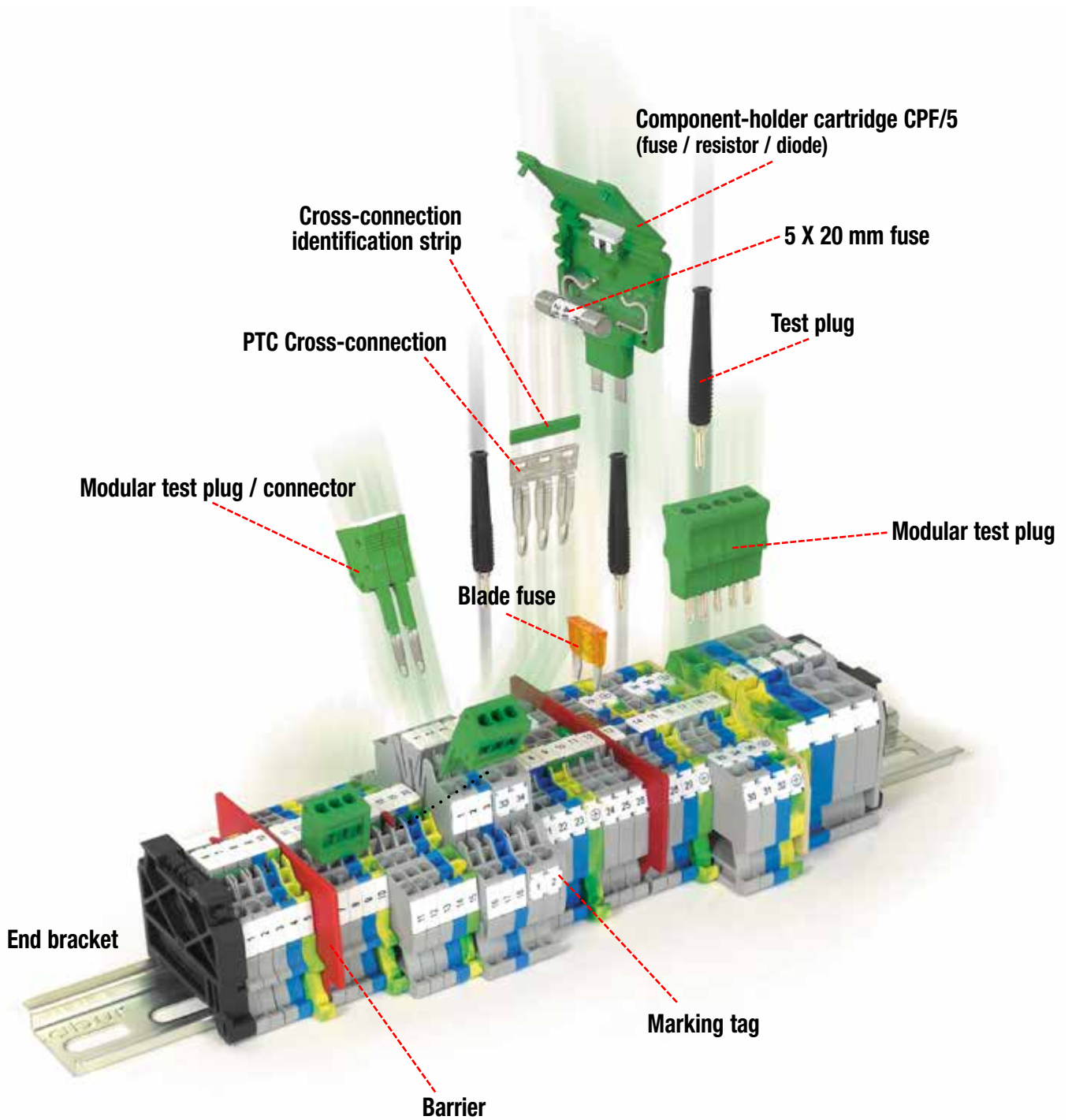

PT end sections

For each model and section of terminal block a particular platelet for insulating and closing the open element of each terminal board is provided. This platelet can be used also to separate different phases of terminal blocks connected in parallel or to increase the insulation distances, when required by particular situations. The end platelets have the **size of the related terminal block** and thickness of 1.5 mm.



Terminal block	End section	
	Type	Cat. No.
Polyamide		
AFO.2/1+1	AFO/PT	AF201
AFO.2/2+2	AFO/PT	AF201
AFO2/2+2/TP	AFO/PT	AF201
CBC.2/GR	CBC.2-10/PT/GR	CB061GR
CBC.4/GR	CBC.2-10/PT/GR	CB061GR
CBC.6/GR	CBC.2-10/PT/GR	CB061GR
CBC.10/GR	CBC.2-10/PT/GR	CB061GR
CBC.16/GR	CBC.16/PT/GR	CB161GR
CBC.35/GR	CBC.35/PT/GR	CB351GR
CBD.2	CB2/PT	CB111
CBD.4	CB4/6/PT	CB241
CBD.6	CB4/6/PT	CB241
CBD.10	CB10/PT	CB431
CBD.16	CB16/PT	CB511
CBD.35	CB35/PT	CB611
CBD.50	CB50/PT	CB711
CBD.70	CB70/PT	CB811
CBE.2	CBR/PT	CR111
CBR.2	CBR/PT	CR111
CVF.4	CVF/PT	CV101
CVF.4/TP	CVF/PT	CV101
CVF.4/TPM	CVF/PT	CV101
CVF.4/VS	CVF/PT	CV101
CVF.4/VS2	CVF/PT	CV101
CVF.4/WW	CVF/PT	CV101
CVF.4/GR	CVF/PT/GR	CV101GR
CVF.4/TP/GR	CVF/PT/GR	CV101GR
DBC.2	DBC/PT	DB101
DAS.4	DAS/PT	DS101
DAS.4/CI	DAS/PT	DS101
DAS.4/SS	DAS/PT	DS101
DSF.4/GR	DFS.4/PT/GR	DS401GR
DSFA.4	DSS/PT	DS301
DSFA.4/GR	DSS/PT/GR	DS301GR
DSS.4	DSS/PT	DS301
DSS.4/GR	DSS/PT/GR	DS301GR
FDP.2	FDP/PT	FD101
FDP.2/GR	FDP/PT/GR	FD101GR
FFS.4	FFS/PT	FF101
FFS.4/GR	FFS/PT/GR	FF101GR
FVS.4	FVS/PT	FV101
FVS.4/GR	FVS/PT/GR	FV101GR
HCD.1/GR	HCD.1/PT/GR	HC201GR
HDE.2/GR	HLD.2/PT/GR	HL201GR
HFR.4/GR	HFR.4/PT/GR	HF211GR
HFR.4/M/GR	HFR.4/PT/GR	HF211GR
HLD.2/GR	HLD.2/PT/GR	HL201GR
HMD.2/GR	HMD/PT/GR	HD101GR
HMF.4/GR	HMF/PT/GR	HF111GR
HSCB.4/GR	HSCB.4/PT/GR	HB101GR
HSCB.6/GR	HSCB.6/PT/GR	HB201GR
HMM.2/GR	HMT.2/PT/GR	HM501GR
HMM.2/1+2/GR	HMT.2/1+2/PT/GR	HM511GR
HMM.2/2+2/GR	HMT.2/2+2/PT/GR	HM521GR
HMM.2/2+2/S/GR	HMT.2/2+2/PT/GR	HM521GR
HMM.4/GR	HMT.4/PT/GR	HM251GR
HMM.1/GR	HMT.1/PT/GR	HM401GR
HMM.1/1+2/GR	HMT.1/1+2/PT	HM411GR
HMM.1/2+2/GR	HMT.1/2+2/PT	HM421GR
HMD.1/GR	HMD.1/PT/GR	HD201GR
HMD.2N/GR	HMD.1/PT/GR	HD201GR
HMM.6/GR	HMT.6/PT/GR	HM321GR
HMS.2/GR	HMT.2/2+2/PT/GR	HM521GR
HMFA.2/GR	HMT.2/1+2/PT/GR	HM511GR

Terminal block	End section	
	Type	Cat. No.
HP.2/GR	HPV/PT/GR	HV111GR
HPC.2/GR	HPV/PT/GR	HV111GR
HPP.2/GR	HP/PT/GR	HP101GR
HTE.2	HMT.2/PT	HM501GR
HTE.2/1+2	HMT.2/1+2/PT	HM511GR
HTE.2/2+2	HMT.2/2+2/PT	HM521GR
HTE.4	HMT.4/PT	HM251GR
HTE.6	HMT.6/PT	HM321GR
HTE.1	HMT.1/PT	HM401GR
HTE.1/1+2	HMT.1/1+2/PT	HM411GR
HTE.1/2+2	HMT.1/2+2/PT	HM421GR
HTTE.2	HLD.2/PT/GR	HL201GR
MPS.2/SV	MPS.2/PT	MP121
MPS.2/SV/GR	MPS.2/PT/GR	MP121GR
MPS.2/SW	MPS.2/PT	MP121
MPS.2/SW/GR	MPS.2/PT/GR	MP121GR
MPS.2/SWP	MPS.2/PT	MP121
MPS.2/SWP/GR	MPS.2/PT/GR	MP121GR
MPS.4	MPS.4/PT	MP901
MPS.4/GR	MPS.4/PT/GR	MP901GR
MPFA.4/GR	MPS.4/PT/GR	MP901GR
MPS.4/SV	MPS.4/PT	MP901
MPS.4/SV/GR	MPS.4/PT/GR	MP901GR
NCS	NCS/PT	NC101
NCV	NCS/PT	NC101
PDF.2	PDF/PT	PF101
RFI.2/GR	RFN/PT/GR	RF101GR
RN.1/GR	RFN/PT/GR	RF101GR
RN.2/GR	RFN/PT/GR	RF101GR
RP.4/GR	RP.4/PT/GR	RP301GR
SCB.4	SCB.4/PT	SB301
SCB.4/GR	SCB.4/PT/GR	SB301GR
SCB.6	SCB.6/PT	SB201
SCB.6/GR	SCB.6/PT/GR	SB201GR
SCB.6/DD	SCB.6/PT	SB201
SCB.6/DD/GR	SCB.6/PT/GR	SB201GR
SCB.10	SCB.10/PT	SB401
SCB.10/GR	SCB.10/PT/GR	SB401GR
SCB.10/CD	SCB.10/PT	SB401
SCB.10/CD/GR	SCB.10/PT/GR	SB401GR
SCB.10/DD	SCB.10/PT	SB401
SCB.10/DD/GR	SCB.10/P/GR	SB401GR
SCB.6/CD	SCB.6/PT	SB201
SCB.6/CD/GR	SCB.6/PT/GR	SB201GR
SFO.4	SFO/PT	SF401
SFO.4/GR	SFO/PT/GR	SF401GR
SFO.4/C....	SFO/PT	SF401
SFR.4	SFR/PT	SF701
SFR.4/C....	SFR/PT	SF701
SFR.4/D1A	SFR/PT	SF701
SFR.4/D3A	SFR/PT	SF701
SFR.4/VS	SFR/PT	SF701
SFR.6	SFR.6/PT	SR301
TC/PO	CB2/PT	CB111
TEO.2	TEO.2/PT	T0901
TEO.4	TEO.4/PT	T0431
TED.4	TEO.4/PT	T0431
TDE.2	TLS/PT	TL101
TDE.2/GR	TLS/PT/GR	TL201GR
TLD.2	TLD/PT	TL201
TLD.2/GR	TLD/PT/GR	TL201GR
TLS.2	TLS/PT	TL101
TLS.2/GR	TLS/PT/GR	TL201GR

Terminal block	End section	
	Type	Cat. No.
TLE.2/GR	TLS/PT/GR	TL201GR
VPC.2	VPC/PT	VP101
VPC.2/GR	VPC/PT/GR	VP101GR
VPD.2/GR	VPD/PT/GR	VP501GR
TR.2	TR.2/PT	TR111
Polyamide (Ex)i		
CBC.2(Ex)i	CBC.2-10/PT(Ex)i	CB1061
CBC.4(Ex)i	CBC.2-10/PT(Ex)i	CB1061
CBC.6(Ex)i	CBC.2-10/PT(Ex)i	CB1061
CBC.10(Ex)i	CBC.2-10/PT(Ex)i	CB1061
CBC.16(Ex)i	CBC.16/PT(Ex)i	CB161
CBC.35(Ex)i	CBC.35/PT(Ex)i	CB1351
CBD.2 (Ex)i	CB2/PT(Ex)i	CBX13
CBD.4(Ex)i	CB4/6/PT (Ex)i	CBX25
CBD.6(Ex)i	CB4/6/PT (Ex)i	CBX25
CBD.10(Ex)i	CB10/PT (Ex)i	CBX44
CBD.16(Ex)i	CB16/PT (Ex)i	CBX53
CBD.35(Ex)i	CB35/PT (Ex)i	CBX63
CBD.50(Ex)i	CB50/PT (Ex)i	CBX73
CBD.70(Ex)i	CB70/PT (Ex)i	CBX83
CVF.4(Ex)i	CVF/PT (Ex)i	CV201
DBC.2(Ex)i	DBC/PT(Ex)i	DB201
DAS.4(Ex)i	DAS/PT (Ex)i	DS201
DAS.4/CI(Ex)i	DAS/PT (Ex)i	DS201
HMD.1(Ex)i	HMD.1/PT(Ex)i	HD301
HMD.2N(Ex)i	HMD.1/PT(Ex)i	HD301
HMM.1(Ex)i	HMT.1/PT (Ex)i	HI401
HMM.1/1+2(Ex)i	HMT.1/1+2/PT(Ex)i	HI411
HMM.1/2+2(Ex)i	HMT.1/2+2/PT(Ex)i	HI421
HMM.2(Ex)i	HMT.2/PT (Ex)i	HI501
HMM.2/1+2(Ex)i	HMT.2/1+2/PT(Ex)i	HI511
HMM.2/2+2(Ex)i	HMT.2/2+2/PT(Ex)i	HI521
HMM.4 (Ex)i	HMT.4/PT (Ex)i	HI251
HMM.4 (Ex)i	HMT.6/PT (Ex)i	HI321
HP.2(Ex)i	HP/PT (Ex)i	HP201
HP.2/P(Ex)i	HP/PT (Ex)i	HP201
HPC.2(Ex)i	HP/PT (Ex)i	HP201
HPC.2/P(Ex)i	HP/PT (Ex)i	HP201
HPP.2(Ex)i	HP/PT (Ex)i	HP201
HPP.2/P(Ex)i	HP/PT (Ex)i	HP201
MPS.2/SW(Ex)i	MPS.2/PT(Ex)i	MP131
MPS.4(Ex)i	MPS.4/PT(Ex)i	MP902
RN.1 (Ex)i	RFN/PT(Ex)i	RF201
RN2 (Ex)i	RFN/PT(Ex)i	RF201
RP.4(Ex)i/PT	RP.4/PT(Ex)i	RP401
SFO.4(Ex)i	SFO.4/PT (Ex)i	SF601
SFR.4(Ex)i	SFR/PT (Ex)i	SF801
SFR.6(Ex)i	SFR.6/PT(Ex)i	SR401
TC/PO(Ex)i	CB2/PT (Ex)i	CBX13
TLD.2(Ex)i	TLD/PT (Ex)i	TL301
VPC.2(Ex)i	VPC.2/PT (Ex)i	VP201
VPD.2(Ex)i	VPD/PT(Ex)i	VP561

End brackets

BTU

Cat. No. **BT005**

Universal end bracket, suitable for rails conforming to both IEC 60715, "G32" type and IEC 60715/TH35 (our types PR/DIN and PR/3); it is mounted directly in the desired position and does not require screw fixing.

- in black polyamide
- thickness: 8 mm



BT0

Cat. No. **BT007**

End bracket suitable for IEC 60715/TH35 rails (our types PR/3); it is mounted directly in the desired position and does not require screw fixing. Particularly suitable if there are rail fixing screws with high heads.

- in black polyamide
- thickness: 8 mm



BT/3

Cat. No. **BT003**

To be mounted on rails in accordance with the IEC 60715/TH35 standard (our type PR/3).

- in black polyamide
- thickness: 8 mm



BT/2

Cat. No. **BT006**

To be mounted on rails in accordance with the IEC 60715/TH15 standard (our type PR/2).



- in black polyamide
- thickness: 8 mm



PTM Series

Tag holder supports



- Universal mounting for both PR/DIN and PR/3 rails which meet IEC 60715 norms, "G32" and TH/35 types
- Made of 6.6 UL94V-0 polyamide - available in grey (RAL 7042)

Support for tags 40 x 16.5 x 0.5 mm		PTM
		Cat. No. PTM
height / width / thickness	 TH/35 7.5 mm	52 / 43 / 19.5
height / width / thickness	 TH/35 15 mm	60 / 43 / 19.5
height / width / thickness	 G32	56 / 47 / 19.5

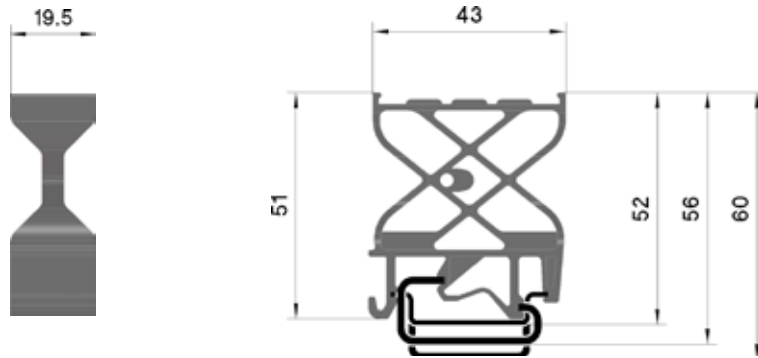

Thanks to the special stop wings, the support can be used both with the adhesive tags provided (together with the product) and with non-adhesive tags of the same size.



Support for tags 40 x 7 x 0.5 mm		PTMS
		Cat. No. PTMS
height / width / thickness	 TH/35 7.5 mm	52 / 43 / 19.5
height / width / thickness	 TH/35 15 mm	60 / 43 / 19.5
height / width / thickness	 G32	56 / 47 / 19.5



Thanks to the special stop wings, the support can be used both with the adhesive tags provided (together with the product) and with non-adhesive tags of the same size.

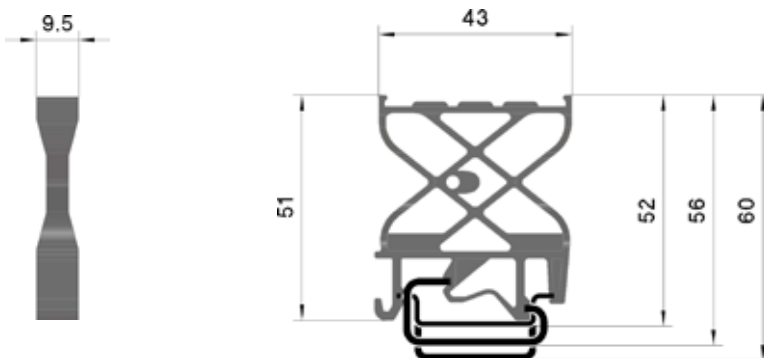

ACCESSORIES			
Adhesive pre-sheared tag	(40 x 16.5 x 0.5 mm)	TA1640AW	TA1640AW
Adhesive pre-sheared tag	(40 x 7 x 0.5 mm)	TA407AW	TA407AW
End bracket		BTU for PR/DIN and PR/3	BT005
		BT/DIN/PO for PR/DIN only	BT001
		BT/3-BTO only for PR/3	BT003-BT007



The height of the tag supports corresponds to that of the CBC.2-10 terminal blocks

Mounting rails

- conforming to IEC 60715/TH35 - 7.5
- conforming to IEC 60715/TH35 - 15
- supports for TH/35 rail
- rail supplied with 2 m bars



DESCRIPTION	TYPE / CAT.NO.	DIAGRAMS
Rail conforming to IEC 60715/TH35 - 7.5 in passivated steel	PR/3/AC Cat. No. PR003	
Rail conforming to IEC 60715/TH35 - 7.5 in white galvanised steel "SENDZMIR" system	PR/3/AC/ZB Cat. No. PR903	
Rail conforming to IEC 60715/TH35 - 7.5 in passivated steel with slots	PR/3/AS Cat. No. PR005	
Rail conforming to IEC 60715/TH35 - 7.5 in white galvanised steel "SENDZMIR" system with slots	PR/3/AS/ZB Cat. No. PR905	
Rail conforming to IEC 60715/TH35 - 15 in passivated steel	PR/3/PP Cat. No. PR007	
Rail conforming to IEC 60715/TH35 - 15 in white galvanised steel "SENDZMIR" system	PR/3/PP/ZB Cat. No. PR907	
Rail conforming to IEC 60715/TH35 - 15 in passivated steel with slots	PR/3/PA Cat. No. PR006	
Rail conforming to IEC 60715/TH35 - 15 in white galvanised steel "SENDZMIR" system with slots	PR/3/PA/ZB Cat. No. PR906	
Support for IEC 60715/TH35 rails in nickel-plated steel with rapid-mounting system 4 MA	ACI121017 Cat. No. Z121017	
Support for IEC 60715/TH35 rails in nickel-plated steel with rapid-mounting system 5 MA	ACI121019 Cat. No. Z121019	

Mounting rails

- conforming to IEC 60715, "G32" type
- conforming to IEC 60715/TH15 - 5.5



DESCRIPTION	TYPE / CAT.NO.	DIAGRAMS
Rail conforming to IEC 60715, "G32" type in passivated steel	PR/DIN/AC Cat. No. PR001	
Rail conforming to IEC 60715, "G32" type in white galvanised steel "SENDZMIR" system	PR/DIN/AC/ZB Cat. No. PR901	
Rail conforming to IEC 60715, "G32" type in passivated steel with slots	PR/DIN/AS Cat. No. PR004	
Rail conforming to IEC 60715, "G32" type in white galvanised steel "SENDZMIR" system with slots	PR/DIN/AS/ZB Cat. No. PR904	
Rail conforming to IEC 60715, "G32" type in aluminium	PR/DIN/AL Cat. No. PR002	
Rail conforming to IEC 60715/TH15 - 5.5 in passivated steel	PR/2/AC Cat. No. PR009	
Rail conforming to IEC 60715/TH15 - 5.5 in white galvanised steel "SENDZMIR" system	PR/2/AC/ZB Cat. No. PR909	
Rail conforming to IEC 60715/TH15 - 5.5 in passivated steel with slots	PR/2/AS Cat. No. PR010	
Rail conforming to IEC 60715/TH15 - 5.5 in white galvanised steel "SENDZMIR" system with slots	PR/2/AS/ZB Cat. No. PR910	

Accessories for mounting rails

- inclined bracket
- conforming to the RoHS Directive



DESCRIPTION	TYPE / CAT.NO.	DIAGRAMS
<p>Zinc-plated inclined bracket Copper 6 x 6 mm busbar holder for mounting of terminal block holder rails, with the possibility of mounting a (collecting) busbar along the entire length of the terminal block.</p>	<p>ACI121116 Cat. No. Z121116</p>	
<p>Zinc-plated inclined bracket Copper 6 x 6 mm busbar holder for mounting of terminal block holder rails, with the possibility of mounting a (collecting) busbar along the entire length of the terminal block.</p>	<p>ACI121301 Cat. No. Z121301</p>	
<p>Zinc-plated inclined bracket Standard type 2 M5 busbar holder with 2 screw fixing.</p>	<p>ACI121311 Cat. No. Z121311</p>	
<p>Zinc-plated inclined bracket Copper type 2 M6 busbar holder with 2 screw fixing.</p>	<p>ACI121314 Cat. No. Z121314</p>	
<p>Inclined bracket at 30° Standard type 6 M6 busbar holder with 1 screw fixing.</p>	<p>ACI121415 Cat. No. Z121415</p>	
<p>Inclined bracket at 45° Standard type 1 M6 busbar holder with 1 screw fixing.</p>	<p>ACI121228 Cat. No. Z121228</p>	

Accessories for mounting rails

- galvanised busbar holder inclined brackets suitable for fixing terminal block holder rails - M6 thread
- conforming to the RoHS Directive



DESCRIPTION	TYPE / CAT.NO.	DIAGRAMS
<p>Inclined rail holder, standard H = 58 mm</p>	<p>ACI121316</p> <p>Cat. No. Z121316</p>	
<p>Inclined rail holder, standard H = 68 mm</p>	<p>ACI121317</p> <p>Cat. No. Z121317</p>	
<p>Inclined rail holder, standard H = 78 mm</p>	<p>ACI121318</p> <p>Cat. No. Z121318</p>	
<p>Inclined rail holder, standard H = 88 mm</p>	<p>ACI121319</p> <p>Cat. No. Z121319</p>	
<p>Inclined rail holder, standard H = 98 mm</p>	<p>ACI121410</p> <p>Cat. No. Z121410</p>	

Accessories for mounting rails

- galvanised standard busbar holder flat brackets suitable for fixing terminal block holder rails, M6 thread
- conforming to the RoHS Directive

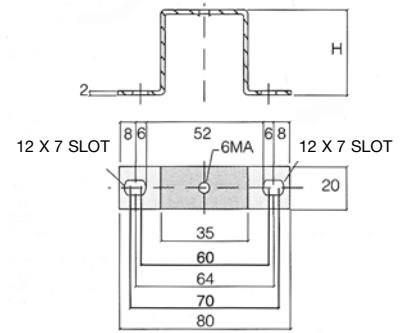

Fixing distance between centers, with 6MA screw, from 60 to 70 mm

DESCRIPTION	TYPE / CAT.NO.	DIAGRAMS
Flat rail support, standard H = 20 mm	ACI121213 Cat. No. Z121213	
Flat rail support, standard H = 25 mm	ACI121214 Cat. No. Z121214	
Flat rail support, standard H = 30 mm	ACI121215 Cat. No. Z121215	
Flat rail support, standard H = 40 mm	ACI121216 Cat. No. Z121216	
Flat rail support, standard H = 50 mm	ACI121217 Cat. No. Z121217	
Flat rail support, standard H = 70 mm	ACI121218 Cat. No. Z121218	
Flat rail support, standard H = 90 mm	ACI121219 Cat. No. Z121219	

Accessories for mounting rails



DESCRIPTION	TYPE / CAT. NO.	DIAGRAMS
6 x 6 mm copper busbar L = 2,000 appropriate for assembly with terminal blocks electrical wire grounding	ACI121123 Cat. No. Z121123	
6 x 6 mm copper busbar blocking terminal with 6 MA x 12 mm screws	ACI121118 Cat. No. Z121118	
Terminal with saddle for 6 x 6 mm copper busbar wire section 0.5-16 mm ²	ACI121119 Cat. No. Z121119	
Terminal with saddle for 6 x 6 mm copper busbar wire section 4-35 mm ²	ACI121121 Cat. No. Z121121	
Special hexagon slot 6 MA x 12 mm screw	ACI121026 Cat. No. Z121026	
Special hexagon slot 5 MA x 10 mm screw	ACI121421 Cat. No. Z121421	
4 MA nut for rapid mounting for 32 x 9 x 15 mm steel bar	ACI121211 Cat. No. Z121211	
5 MA nut for rapid mounting for 32 x 9 x 15 mm steel bar	ACI121212 Cat. No. Z121212	
6 x 6 mm copper busbar blocking terminal with 6 MA x 25 mm screws	ACI121221 Cat. No. Z121221	
Inclined copper busbar support with 6 MA x 10 mm screws and 6 MA nut	ACI121307 Cat. No. Z121307	

Pre-assembled cross connections

- These are supplied pre-assembled for 2-3-5-10 poles.
- They enable cross connection of two or more contiguous terminal blocks and are placed in an **accident prevention position** with respect to the outside.
- All the components are made of brass with nickel-plating surface treatment.



Screw-clamp terminal blocks

Terminal block	2-pole jumper		3-pole jumper		5-pole jumper		10-pole jumper	
	Type	Cat. No.	Type	Cat. No.	Type	Cat. No.	Type	Cat. No.
CBD.2	PM/20/2	PM202	PM/20/3	PM203	PM/20/5	PM205	PM/20/10	PM210
CBD.4	PM/40/2	PM402	PM/40/3	PM403	PM/40/5	PM405	PM/40/10	PM400
CBD.6	PM/60/2	PM602	PM/60/3	PM603	PM/60/5	PM605	PM/60/10	PM610
CBD.10	PM/10/2	PM102	PM/10/3	PM103	PM/10/5	PM105	PM/10/10	PM100
CBR.2	PM/25/2	PM252	PM/25/3	PM253	PM/25/5	PM255	PM/25/10	PM250
CVF.4	PM/40/2	PM402	PM/51/3	PM513	PM/51/5	PM515	PM/51/10	PM510
DAS.4	PM/41/2	PM412	PM/51/3	PM513	PM/51/5	PM515	PM/51/10	PM510
RN.1	PM/11/2	PM112	PM/11/3	PM113	PM/11/5	PM115	PM/11/10	PM110
RP.4	PM/41/2	PM412	PM/51/3	PM513	PM/51/5	PM515	PM/51/10	PM510
SCB.4	PM/41/2	PM412	PM/41/3	PM413	PM/41/5	PM415	PM/41/10	PM410
TDE.2	PM/20/2	PM202	PM/30/3	PM303	PM/30/5	PM305	PM/30/10	PM310
TLD.2	PM/20/2	PM202	PM/30/3	PM303	PM/30/5	PM305	PM/30/10	PM310
TLE.2	PM/20/2	PM202	PM/30/3	PM303	PM/30/5	PM305	PM/30/10	PM310
TLS.2	PM/20/2	PM202	PM/30/3	PM303	PM/30/5	PM305	PM/30/10	PM310
RN.2	PM/12/2	PM122	PM/12/3	PM123	PM/12/5	PM125	PM/12/10	PM120
Insulated jumper								
MAC.6	PIL/2 (2 poles)	PIL02	PIL/3 (3 poles)	PIL03	PIL/4 (4 poles)	PIL04	PIL/8 (8 poles)	PIL08

Cross connections

Easy Bridge System

- snap coupling, with no screws
- possibility of cross and offset-pole connection
- when inserted, **intrinsically IPXXB protected installation**, without the aid of further insulating protections
- system covered by patent

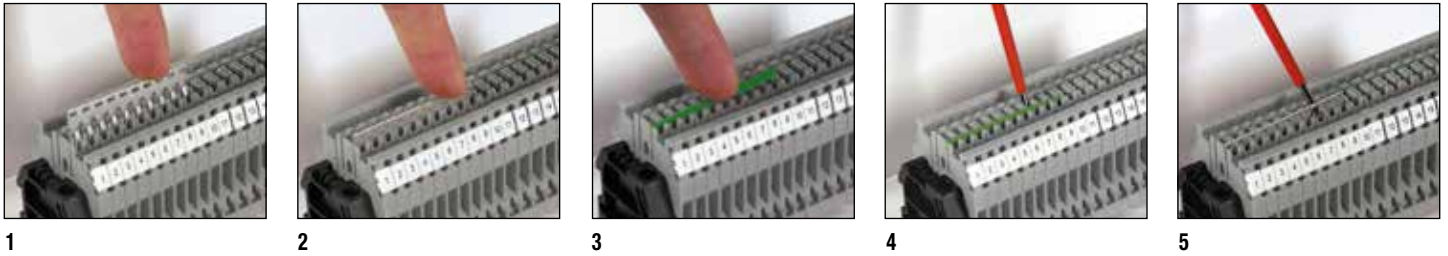
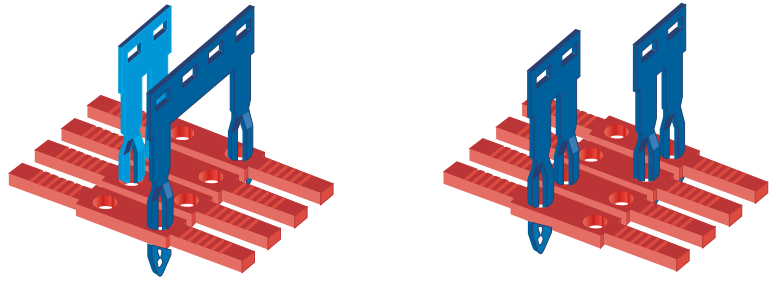

- 1-2** After cutting the bar for the number of poles necessary, insert the cross connection in the special cavity of the terminal block. At this point working with the tip of a screwdriver, push the cross connection up to the locking point. The cross connection will be completely isolated and intrinsically IPXXB protected.
- 3-4** After inserting the cross connection, the poles connected can be highlighted with the aid of the green insert, PTC/SP. This accessory is supplied in the standard length of 100 mm and can easily be sliced with the aid of a simple cutter.
- 5** To remove the cross connection it is sufficient to remove the PTC/SP insert, insert the tip of the screwdriver in the slot of the cross connection itself, lever it and pull it out.

Terminal block	2-pole jumper		3-pole jumper		5-pole jumper		10-pole jumper		Jumper l = 250 mm		
	Type	Cat. No.	Type	Cat. No.	Type	Cat. No.	Type	Cat. No.	Type	Cat. No.	Poles
CBC.2 (*)	PTC/2/02	PTC0202	PTC/2/03	PTC0203	PTC/2/05	PTC0205	PTC/2/10	PTC0210	PTC/2/00	PTC0200	50
CBC.4 (*)	PTC/4/02	PTC0402	PTC/4/03	PTC0403	PTC/4/05	PTC0405	PTC/4/10	PTC0410	PTC/4/00	PTC0400	42
CBC.6 (*)	PTC/6/02	PTC0602	PTC/6/03	PTC0603	PTC/6/05	PTC0605	PTC/6/10	PTC0610	PTC/6/00	PTC0600	31
CBC.10 (*)	PTC/10/02	PTC1002	PTC/10/03	PTC1003	PTC/10/05	PTC1005	PTC/10/10	PTC1010	PTC/10/00	PTC1000	25
DBC.2 (*)	PTC/2/02	PTC0202	PTC/2/03	PTC0203	PTC/2/05	PTC0205	PTC/2/10	PTC0210	PTC/2/00	PTC0200	50
DSFA.4 (*)	PTC/4/02	PTC0402	PTC/4/03	PTC0403	PTC/4/05	PTC0405	PTC/4/10	PTC0410	PTC/4/00	PTC0400	42
DSS.4 (*)	PTC/4/02	PTC0402	PTC/4/03	PTC0403	PTC/4/05	PTC0405	PTC/4/10	PTC0410	PTC/4/00	PTC0400	42
HMM.1/GR (**)	PTC/1/02	PTC0102	PTC/1/03	PTC0103	PTC/1/05	PTC0105	PTC/1/10	PTC0110	PTC/1/00	PTC0100	50
HMD.1/GR	PTC/1/02	PTC0102	PTC/1/03	PTC0103	PTC/1/05	PTC0105	PTC/1/10	PTC0110	PTC/1/00	PTC0100	50
HCD.1/GR	PTC/2/02	PTC0202	PTC/2/03	PTC0203	PTC/2/05	PTC0205	PTC/2/10	PTC0210	PTC/2/00	PTC0200	50
HDE.2/GR (**)	PTC/3/02	PTC0302	PTC/3/03	PTC0303	PTC/3/05	PTC0305	PTC/3/10	PTC0310	PTC/3/00	PTC0300	47
HLD.2/GR (**)	PTC/3/02	PTC0302	PTC/3/03	PTC0303	PTC/3/05	PTC0305	PTC/3/10	PTC0310	PTC/3/00	PTC0300	47
HFR.4/GR	PTC/5/02	PTC0502	-	-	-	-	-	-	-	-	-
HFR.4/M/GR	PTC/5/02	PTC0502	PTC/5/03	PTC0503	PTC/5/05	PTC0505	PTC/5/10	PTC0510	PTC/5/00	PTC0500	40
HMM.2/GR (**)	PTC/3/02	PTC0302	PTC/3/03	PTC0303	PTC/3/05	PTC0305	PTC/3/10	PTC0310	PTC/3/00	PTC0300	47
HMS.2/GR	PTC/3/02	PTC0302	PTC/3/03	PTC0303	PTC/3/05	PTC0305	PTC/3/10	PTC0310	PTC/3/00	PTC0300	47
HMFA.2/GR	PTC/3/02	PTC0302	PTC/3/03	PTC0303	PTC/3/05	PTC0305	PTC/3/10	PTC0310	PTC/3/00	PTC0300	47
HMM.4/GR (**)	PTC/5/02	PTC0502	PTC/5/03	PTC0503	PTC/5/05	PTC0505	PTC/5/10	PTC0510	PTC/5/00	PTC0500	40
HMFA.2/GR	PTC/3/02	PTC0302	PTC/3/03	PTC0303	PTC/3/05	PTC0305	PTC/3/10	PTC0310	PTC/3/00	PTC0300	47
HSCB.4/GR	PTC/5/02	PTC0502	PTC/5/03	PTC0503	PTC/5/05	PTC0505	PTC/5/10	PTC0510	PTC/5/00	PTC0500	40
HSCB.6/GR	PTC/8/02	PTC0802	PTC/8/03	PTC0803	PTC/8/05	PTC0805	PTC/8/10	PTC0810	PTC/8/00	PTC0800	30
HMM.6/GR	PTC/8/02	PTC0802	PTC/8/03	PTC0803	PTC/8/05	PTC0805	PTC/8/10	PTC0810	PTC/8/00	PTC0800	30
HMM.10/GR	PTC/11/02	PTC1102	PTC/11/03	PTC1103	PTC/11/05	PTC1105	PTC/11/10	PTC1110	PTC/11/00	PTC1100	25
HMM.16/GR	PTC/16/02	PTC1602	PTC/16/03	PTC1603	PTC/16/05	PTC1605	PTC/16/10	PTC1610	PTC/16/00	PTC1600	20
HVPC.2/GR	PTC/3/02	PTC0302	PTC/3/03	PTC0303	PTC/3/05	PTC0305	PTC/3/10	PTC0310	PTC/3/00	PTC0300	47
CHP.2/GR	PTC/3/02	PTC0302	PTC/3/03	PTC0303	PTC/3/05	PTC0305	PTC/3/10	PTC0310	PTC/3/00	PTC0300	47
CHP.2D/GR	PTC/3/02	PTC0302	PTC/3/03	PTC0303	PTC/3/05	PTC0305	PTC/3/10	PTC0310	PTC/3/00	PTC0300	47
HPP.2/GR	PTC/3/02	PTC0302	PTC/3/03	PTC0303	PTC/3/05	PTC0305	PTC/3/10	PTC0310	PTC/3/00	PTC0300	47
HP.2/GR	PTC/3/02	PTC0302	PTC/3/03	PTC0303	PTC/3/05	PTC0305	PTC/3/10	PTC0310	PTC/3/00	PTC0300	47
HPC.2/GR	PTC/3/02	PTC0302	PTC/3/03	PTC0303	PTC/3/05	PTC0305	PTC/3/10	PTC0310	PTC/3/00	PTC0300	47
MPS.4 (*)	PTC/4/02	PTC0402	PTC/4/03	PTC0403	PTC/4/05	PTC0405	PTC/4/10	PTC0410	PTC/4/00	PTC0400	42
MPFA.4 (*)	PTC/4/02	PTC0402	PTC/4/03	PTC0403	PTC/4/05	PTC0405	PTC/4/10	PTC0410	PTC/4/00	PTC0400	42
SFR.6 (*)	PTC/20/02	PTC2002	PTC/20/03	PTC2003	PTC/20/05	PTC2005	PTC/20/10	PTC2010	PTC/20/00	PTC2000	25
VPC.2 (*)	PTC/2/02	PTC0202	PTC/2/03	PTC0203	PTC/2/05	PTC0205	PTC/2/10	PTC0210	PTC/2/00	PTC0200	50
VPD.2 (*)	PTC/2/02	PTC0202	PTC/2/03	PTC0203	PTC/2/05	PTC0205	PTC/2/10	PTC0210	PTC/2/00	PTC0200	50

(*) Article available also in grey.

(**) Including the versions /1+2, /2+2 and/or the corresponding earth terminal blocks, if available.

Cross connections

Easy Bridge System

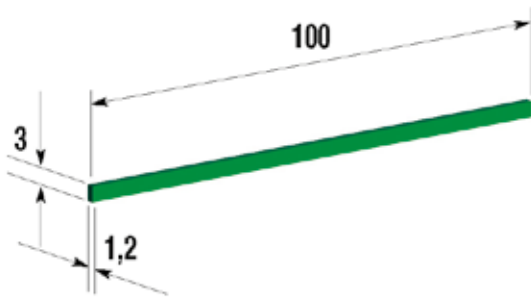

In addition to the traditional Easy Bridge system, the new Easy Bridge Plus cross connection, with high visibility, is now available.

In panels with little light, seeing clearly where the cross connections are inserted is not always immediate and easy if particular attention is not paid; this can cause connection errors.

It is precisely to solve this problem that Cabur has created a marker to be used on its terminal blocks that adopt PTC cross connections, in order to make locating them easier, after insertion.

A **single model was created (PTC/SP - Cat. No. PTC0990)** common to all terminal blocks, irrespective of the pitch or the model of the PTC cross connection used. The marker must be housed in the cross-connection seat; stability on the terminal block is guaranteed by the friction on the walls of the cross-connection insertion grooves.

Examples of application on the HMM.2 terminal block

The dimensions of the marker have been studied so as not to protrude from the profile of any of the terminal blocks on which it can be applied, so as not to interfere with numbering, cables or other accessories.

The marker can be applied also in the case of double cross connections. It is to be noted that the marker can be applied in the presence of other accessories, without having to be extracted in advance.

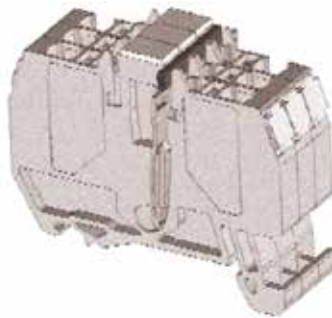

Examples of application on the VPD.2 terminal block

The marker is produced in sticks of a length of 100 mm each and is supplied in green. Users can autonomously reduce its length according to their needs.

The cutting operation is possible with no difficulty using a common pair of pliers, because the thickness of the sticks, made of polyamide, is only 1.20 mm.

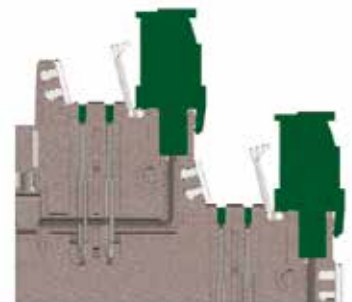
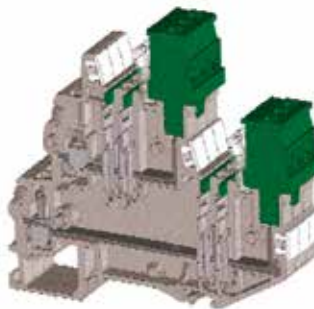

NOTE. Application of the PTC/SP marker is possible on all terminal blocks that adopt PTC cross connections (as in the list) with the exception of the HCD.1 and HMD.2N terminal blocks: in these two terminal blocks the shape of the cross-connection seat makes it impossible to obtain the friction necessary to guarantee stably the positioning and permanence. In the same way the cross connections of these two terminal blocks have a less deep introduction compared to all the others and therefore the presence of the cross connection can be seen without the need for the marker.

Cross connections

Easy Bridge Plus System

- Snap coupling, with no screws
- Possibility of cross and offset-pole connections
- After insertion, the cross connection is intrinsically IPXXB protected
- Colours **red** or **blue** for immediate visibility of the cross connection and identification of polarity or phase
- Upper surface markable with indelible marker pen

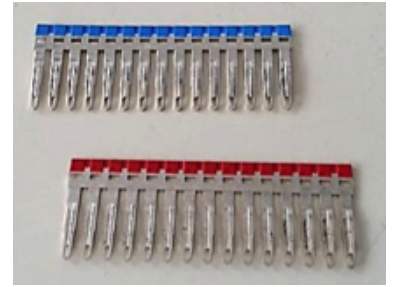

1



2

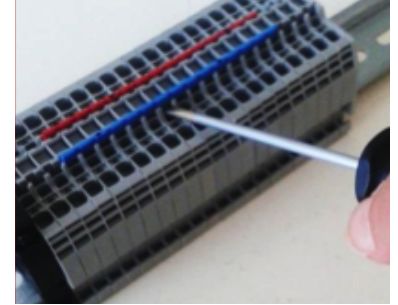

3

1. After cutting the bar for the number of poles necessary, insert the cross connection in the special seat in the terminal block. With the tip of the screwdriver push the cross-connection until it comes to a stop. The cross connection will be completely insulated, intrinsically IPXXB protected and visible.
2. The upper surface can be marked with an indelible marker pen to indicate the presence of the pole and of the electrical connection with the underlying terminal block in cross connections with alternating poles
3. To remove the cross connection it is sufficient to insert the tip of the screwdriver in the slot of the cross connection itself and lever it to pull it out; with cross connections of more than 5 poles lever gradually at the centre and at the two ends until it is completely extracted

Terminal block	Jumper colour	2-pole jumper		3-pole jumper		5-pole jumper		10-pole jumper		30-pole jumper	
		Type	Cat. No.	Type	Cat. No.	Type	Cat. No.	Type	Cat. No.	Type	Cat. No.
CBC.2/GR	RED	PTP/2/02/R	PTP0202R	PTP/2/03/R	PTP0203R	PTP/2/05/R	PTP0205R	PTP/2/10/R	PTP0210R	PTP/2/30/R	PTP0230R
	BLUE	PTP/2/02/B	PTP0202B	PTP/2/03/B	PTP0203B	PTP/2/05/B	PTP0205B	PTP/2/10/B	PTP0210B	PTP/2/30/B	PTP0230B
CBC.4/GR	RED	PTP/4/02/R	PTP0402R	PTP/4/03/R	PTP0403R	PTP/4/05/R	PTP0405R	PTP/4/10/R	PTP0410R	PTP/4/30/R	PTP0430R
	BLUE	PTP/4/02/B	PTP0402B	PTP/4/03/B	PTP0403B	PTP/4/05/B	PTP0405B	PTP/4/10/B	PTP0410B	PTP/4/30/B	PTP0430B
CBS.2 and CBS.2/GR	RED	PTP/2/02/R	PTP0202R	PTP/2/03/R	PTP0203R	PTP/2/05/R	PTP0205R	PTP/2/10/R	PTP0210R	PTP/2/30/R	PTP0230R
	BLUE	PTP/2/02/B	PTP0202B	PTP/2/03/B	PTP0203B	PTP/2/05/B	PTP0205B	PTP/2/10/B	PTP0210B	PTP/2/30/B	PTP0230B
CBS.4 and CBS.4/GR	RED	PTP/4/02/R	PTP0402R	PTP/4/03/R	PTP0403R	PTP/4/05/R	PTP0405R	PTP/4/10/R	PTP0410R	PTP/4/30/R	PTP0430R
	BLUE	PTP/4/02/B	PTP0402B	PTP/4/03/B	PTP0403B	PTP/4/05/B	PTP0405B	PTP/4/10/B	PTP0410B	PTP/4/30/B	PTP0430B
CBF.4/GR	RED	PTP/4/02/R	PTP0402R	PTP/4/03/R	PTP0403R	PTP/4/05/R	PTP0405R	PTP/4/10/R	PTP0410R	PTP/4/30/R	PTP0430R
	BLUE	PTP/4/02/B	PTP0402B	PTP/4/03/B	PTP0403B	PTP/4/05/B	PTP0405B	PTP/4/10/B	PTP0410B	PTP/4/30/B	PTP0430B
HMM.2/GR (*)	RED	PTP/3/02/R	PTP0302R	PTP/3/03/R	PTP0303R	PTP/3/05/R	PTP0305R	PTP/3/10/R	PTP0310R	PTP/3/30/R	PTP0330R
	BLUE	PTP/3/02/B	PTP0302B	PTP/3/03/B	PTP0303B	PTP/3/05/B	PTP0305B	PTP/3/10/B	PTP0310B	PTP/3/30/B	PTP0330B
HMM.4/GR (*)	RED	PTP/5/02/R	PTP0502R	PTP/5/03/R	PTP0503R	PTP/5/05/R	PTP0505R	PTP/5/10/R	PTP0510R	PTP/5/30/R	PTP0530R
	BLUE	PTP/5/02/B	PTP0502B	PTP/5/03/B	PTP0503B	PTP/5/05/B	PTP0505B	PTP/5/10/B	PTP0510B	PTP/5/30/B	PTP0530B
HMD.2N/GR	RED	PTP/3/02/R	PTP0302R	PTP/3/03/R	PTP0303R	PTP/3/05/R	PTP0305R	PTP/3/10/R	PTP0310R	PTP/3/30/R	PTP0330R
	BLUE	PTP/3/02/B	PTP0302B	PTP/3/03/B	PTP0303B	PTP/3/05/B	PTP0305B	PTP/3/10/B	PTP0310B	PTP/3/30/B	PTP0330B
HLD.2/GR (*)	RED	PTP/3/02/R	PTP0302R	PTP/3/03/R	PTP0303R	PTP/3/05/R	PTP0305R	PTP/3/10/R	PTP0310R	PTP/3/30/R	PTP0330R
	BLUE	PTP/3/02/B	PTP0302B	PTP/3/03/B	PTP0303B	PTP/3/05/B	PTP0305B	PTP/3/10/B	PTP0310B	PTP/3/30/B	PTP0330B
HDE.2/GR (*)	RED	PTP/3/02/R	PTP0302R	PTP/3/03/R	PTP0303R	PTP/3/05/R	PTP0305R	PTP/3/10/R	PTP0310R	PTP/3/30/R	PTP0330R
	BLUE	PTP/3/02/B	PTP0302B	PTP/3/03/B	PTP0303B	PTP/3/05/B	PTP0305B	PTP/3/10/B	PTP0310B	PTP/3/30/B	PTP0330B
CHP.2/GR (*)	RED	PTP/3/02/R	PTP0302R	PTP/3/03/R	PTP0303R	PTP/3/05/R	PTP0305R	PTP/3/10/R	PTP0310R	PTP/3/30/R	PTP0330R
	BLUE	PTP/3/02/B	PTP0302B	PTP/3/03/B	PTP0303B	PTP/3/05/B	PTP0305B	PTP/3/10/B	PTP0310B	PTP/3/30/B	PTP0330B
CHP.2D/GR (*)	RED	PTP/3/02/R	PTP0302R	PTP/3/03/R	PTP0303R	PTP/3/05/R	PTP0305R	PTP/3/10/R	PTP0310R	PTP/3/30/R	PTP0330R
	BLUE	PTP/3/02/B	PTP0302B	PTP/3/03/B	PTP0303B	PTP/3/05/B	PTP0305B	PTP/3/10/B	PTP0310B	PTP/3/30/B	PTP0330B
HVPC.2/GR(*)	RED	PTP/3/02/R	PTP0302R	PTP/3/03/R	PTP0303R	PTP/3/05/R	PTP0305R	PTP/3/10/R	PTP0310R	PTP/3/30/R	PTP0330R
	BLUE	PTP/3/02/B	PTP0302B	PTP/3/03/B	PTP0303B	PTP/3/05/B	PTP0305B	PTP/3/10/B	PTP0310B	PTP/3/30/B	PTP0330B
HMS.2/GR	RED	PTP/3/02/R	PTP0302R	PTP/3/03/R	PTP0303R	PTP/3/05/R	PTP0305R	PTP/3/10/R	PTP0310R	PTP/3/30/R	PTP0330R
	BLUE	PTP/3/02/B	PTP0302B	PTP/3/03/B	PTP0303B	PTP/3/05/B	PTP0305B	PTP/3/10/B	PTP0310B	PTP/3/30/B	PTP0330B
HMFA.2/GR	RED	PTP/3/02/R	PTP0302R	PTP/3/03/R	PTP0303R	PTP/3/05/R	PTP0305R	PTP/3/10/R	PTP0310R	PTP/3/30/R	PTP0330R
	BLUE	PTP/3/02/B	PTP0302B	PTP/3/03/B	PTP0303B	PTP/3/05/B	PTP0305B	PTP/3/10/B	PTP0310B	PTP/3/30/B	PTP0330B
HSCB.4/GR	RED	PTP/3/02/R	PTP0302R	PTP/3/03/R	PTP0303R	PTP/3/05/R	PTP0305R	PTP/3/10/R	PTP0310R	PTP/3/30/R	PTP0330R
	BLUE	PTP/3/02/B	PTP0302B	PTP/3/03/B	PTP0303B	PTP/3/05/B	PTP0305B	PTP/3/10/B	PTP0310B	PTP/3/30/B	PTP0330B
HFR.4/M/GR	RED	PTP/3/02/R	PTP0302R	PTP/3/03/R	PTP0303R	PTP/3/05/R	PTP0305R	PTP/3/10/R	PTP0310R	PTP/3/30/R	PTP0330R
	BLUE	PTP/3/02/B	PTP0302B	PTP/3/03/B	PTP0303B	PTP/3/05/B	PTP0305B	PTP/3/10/B	PTP0310B	PTP/3/30/B	PTP0330B

(*) Including the versions /1+2, /2+2 and the corresponding earth terminal blocks, if available.

Cross connections

Easy Bridge and Easy Bridge Plus Systems

To guarantee the correct safety conditions, after insertion and depending on the multiple connection schemes obtainable using the PTC/PTP cross connections, the table below is provided:

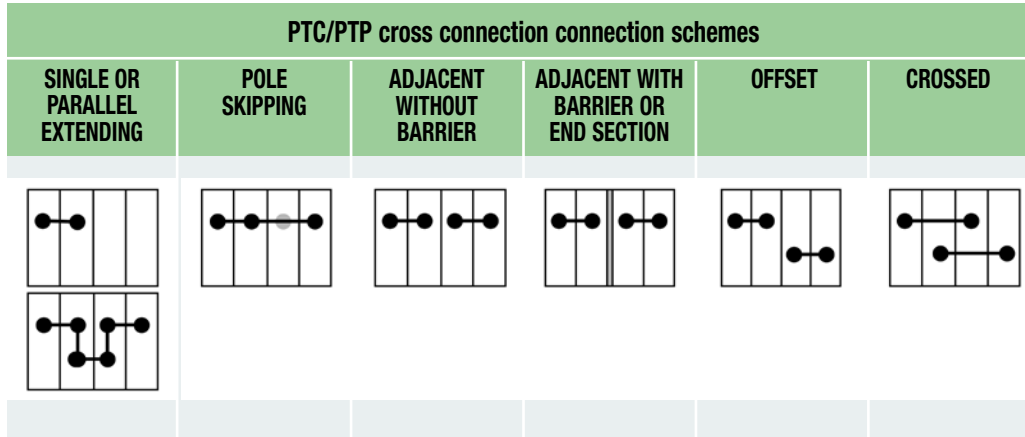

Terminal block	Jumper type	Isolation voltage in the above configurations (V)					
		1	2	3	4	5	6
CBC.2	PTC/2 PTP/2	630	630	-	500	500	500
CBC.4	PTC/4 PTP/4	630	500	-	500	500	500
CBC.6	PTC/6	630	630	-	630	630	500
CBC.10	PTC/10	800	630	-	630	800	500
VPC.2	PTC/2	320	320	-	320	320	320
HMFA.2 - HMS.2	PTC/3	630	500	-	500 (*)	-	-
HMM.1 Series	PTC/1	630	630	-	320	630	630
HMM.2 Series	PTC/3 PTP/3	630	500	-	500 (*)	630	630
HMM.4 Series	PTC/5 PTP/5	500	500	-	500 (*)	500	500
HMM.10	PTC/11	1000	1000	-	800	1000	1000
HMM.16	PTC/16	1000	1000	-	800	1000	800
DBC.2	PTC/2	630	500	-	250 (**)	500	500
HCD.1	PTC/2	320	320	-	630 (***)	500	500
HVPC.2/GR	PTC/3	500	500	-	320	320	320
CHP.2/GR - CHP.2D/GR	PTC/11	500 (630)	500	-	500 (*)	500	500
HPP.2/GR - HP.2/GR	PTC/3	400	400	-	400 (*)	-	-
HPC.2/GR	PTC/3	400	400	-	800 (PT)	500	400
SFR.6	PTC/20	630	630	400	800 (PT)	400	400
MPS.4-MPFA.4	PTC/4	400	400	-	630	630	500
DSS.4-DSFA.4	PTC/4	400	400	-	400	-	-
HMD.1	PTC/1	500	500	-	400	-	-
VPD.2	PTC/1	500	500	-	320	500	500
VPD.2	PTC/2	320	320	-	320	320	320
HSCB.4	PTC/5	500	500	-	500 (*)	500	500
HSCB.6	PTC/8	500	500	-	400	500	500

Notes: (*) with interposition of end platelet
 (**) between lower adjacent cross connections (with barrier)
 (***) between upper adjacent cross connections (with barrier)



Cross connections

For HMD.2 and FDP.2 terminal blocks



PH jumper

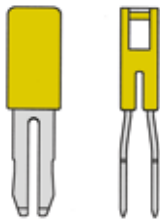

PHD/2 jumper



HMD.2/GR cat. no. HD100GR

Terminal block	Jumper type	Cat. No.
HMD.2	PH/2.5-4	PH100
FDP.2	PH/2.5-4	PH100

NOTE:
To complete the insertion of the jumpers,
the use of screwdriver is necessary.

For Mini spring-clamp terminal blocks

Terminal block	2-pole jumper		3-pole jumper		5-pole jumper	
	Type	Cat. No.	Type	Cat. No.	Type	Cat. No.
HP.2/P	PTC/2/02	PTC0202	PTC/2/03	PTC0203	PTC/2/05	PTC0205
HPC.2/P	PTC/2/02	PTC0202	PTC/2/03	PTC0203	PTC/2/05	PTC0205
HPP.2/P	PTC/2/02	PTC0202	PTC/2/03	PTC0203	PTC/2/05	PTC0205



POF permanent cross connections

They enable cross connection of two adjacent terminal blocks and are placed in an accident prevention position with respect to the outside.



The **POF** is made up of:

- 2 screws
- 2 sleeves
- 1 plate with 2 holes

All the components are in brass, with nickel plating.

NOTE:

For terminal blocks that normally require POF connections, where they are to be inserted in "increased safety" installations (Ex e), the use of **PFX** cross connections is required; they include an anti-loosening washer.

Terminal block	Jumper type	Cat. No.	Screw M x l (mm)	Sleeve Ø x l (mm)	Plate l x s (mm)
CBC.16	POF/53	POF53	M4 x 21	8 x 15	7 x 1.5
CBC.35	POF/35	POF35	M4 x 21	8 x 12	10 x 4
CBD.16	POF/44	POF44	M4 x 16	6 x 9.5	7 x 1.5
CBD.35	POF/06	POF06	M4 x 21	8 x 12	8 x 2.5
CBD.50	POF/07	POF07	M5 x 20	8 x 12	10 x 2.5
CBD.70	POF/08	POF08	M5 x 25	8 x 15	10 x 2.5
NCS	POF/99	POF99	M3 x 5	-	5.5 x 0.6
NCV	POF/99	POF99	M3 x 5	-	5.5 x 0.6
RFL.2	POF/17	POF17	M2.5 x 13.5	4 x 8	4 x 0.8
SCB.6	POF/57	POF57	M3.5 x 28	6 x 19	7 x 1
SCB.10	POF/56	POF56	M4.5 x 20	7 x 13.5	7 x 1.5
SCX.10	POF/56	POF56	M4.5 x 12	7 x 13.5	7 x 1.5
SFO.4	POF/20	POF20	M3 x 20	4 x 16	5.5 x 0.6
SV.2	POF/11	POF11	M2.5 x 13.5	4 x 10	5.5 x 0.6
SV.4	POF/12	POF12	M3 x 14	4 x 10	5.5 x 0.6
SV.6	POF/13	POF13	M3 x 20	5.5 x 13.5	7 x 1
SV.10	POF/14	POF14	M3.5 x 21	5.5 x 16	7 x 1.5
VL.16	POF/55	POF55	M4 x 12	6 x 6.5	8 x 2
VLM.10	POF/54	POF54	M4 x 12	5.5 x 7.5	7 x 1.5
GPM.95 (2 poles)	POF/95/2	P0952	M5 x 20	-	10 x 10
GPM.95 (3 poles)	POF/95/3	P0953	M5 x 20	-	10 x 10
GPM.150 (2 poles)	POF/150/2	P0152	M5 x 20	-	10 x 10
GPM.150 (3 poles)	POF/150/3	P0153	M5 x 20	-	10 x 10
GPM.240 (2 poles)	POF/240/2	P0242	M5 x 30	-	10 x 15
GPM.240 (3 poles)	POF/240/3	P0243	M5 x 30	-	10 x 15
GPA.70 - GPA.70/FIX	POF/70	POF70	M5 x 35	8 x 23.5	10 x 3

PMP commoning bars

CPM shunting screws and sleeves

The **PMP** commoning bar, suitable for multiple connection of several terminal blocks, whether adjacent or not, is supplied in 250 mm sections with holes adequate for the pitch of each terminal block. The bar is supported and fixed, in correspondence with each element, by a special **CPM** sleeve screw.

In use on terminal boards destined for “increased safety” (Ex e) plants the CPM screws/sleeves are fitted with self-locking washers and their part number is changed to **CPX**.

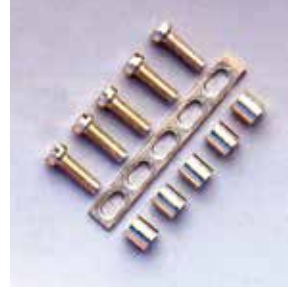

Terminal block	Commoning bar		l x s mm	Number of holes (x 250 mm)	Screw/sleeve		Screw/sleeve (Ex e)	
	Type	Cat. No.			Type	Cat. No.	Type	Cat. No.
CBC.16	PMP/05	PMP05	7 x 1.5	21	CPM/53	CPM53	CPX/53	CPX53
CBC.35	PMP/35	PMP35	10 x 4	16	CPM/35	CPM35	CPX/35	CPX35
CBD.2	PMP/01	PMP01	5.5 x 0.6	45	CPM/21	CPM21	CPX/21	CPX21
CBD.4	PMP/42	PMP42	5.5 x 0.6	38	CPM/12	CPM12	CPX/12	CPX12
CBD.6	PMP/13	PMP13	7 x 1	31	CPM/83	CPM83	CPX/83	CPX83
CBD.10	PMP/04	PMP04	7 x 1.5	25	CPM/03	CPM03	CPX/03	CPX03
CBD.16	PMP/05	PMP05	7 x 1.5	21	CPM/44	CPM44	CPX/44	CPX44
CBD.35	PMP/06	PMP06	8 x 2.5	16	CPM/06	CPM06	CPX/06	CPX06
CBD.50	PMP/07	PMP07	10 x 2.5	14	CPM/07	CPM07	CPX/07	CPX07
CBD.70	PMP/08	PMP08	10 x 2.5	12	CPM/08	CPM08	CPX/08	CPX08
CBR.2	PMP/25	PMP25	5.5 x 0.6	50	CPM/25	CPM25	-	-
CVF.4	PMP/58	PMP58	5.5 x 0.6	42	CPM/12	CPM12	-	-
DAS.4	PMP/58	PMP58	5.5 x 0.6	42	CPM/01	CPM01	CPX/01	CPX01
FFS.4	PMP/42	PMP42	5.5 x 0.6	38	CPM/01	CPM01	CPX/01	CPX01
FVS.4	PMP/42	PMP42	5.5 x 0.6	38	CPM/01	CPM01	CPX/01	CPX01
GPA.70 - GPA.70/FIX	PMP/08	PMP08	10 x 2.5	12	CPM/70	CPM70	-	-
NCS	PMP/02	PMP02	5.5 x 0.6	40	CPM/99	CPM99	-	-
NCV	PMP/02	PMP02	5.5 x 0.6	40	CPM/99	CPM99	-	-
RFI.2	PMP/17	PMP17	4 x 0.8	42	CPM/17	CPM17	-	-
RN.1	PMP/16	PMP16	5.5 x 0.6	59	CPM/16	CPM16	-	-
RN.2	PMP/25	PMP25	5.5 x 0.6	50	CPM/16	CPM16	CPX/16	CPX16
RP.4	PMP/58	PMP58	5.5 x 0.6	42	CPM/01	CPM01	CPX/01	CPX01
SCB.4	PMP/02	PMP02	5.5 x 0.6	40	CPM/01	CPM01	-	-
SCB.6	PMP/13	PMP13	7 x 1	31	CPM/57	CPM57	-	-
SCB.10	PMP/56	PMP56	7 x 1.5	24	CPM/56	CPM56	-	-
TDE.2	PMP/02	PMP02	5.5 x 0.6	40	CPM/21	CPM21	-	-
TLD.2	PMP/02	PMP02	5.5 x 0.6	40	CPM/21	CPM21	-	-
TLE.2	PMP/02	PMP02	5.5 x 0.6	40	CPM/21	CPM21	-	-
TLS.2	PMP/02	PMP02	5.5 x 0.6	40	CPM/21	CPM21	-	-

POS switchable cross connections

If the linking of adjacent terminal blocks is occasional, a **POS** switchable cross connection may be used; it consists of:

- 2 screws
- 2 sleeves
- 1 linking plate with open slot, allowing easy opening and closing of the cross connection.

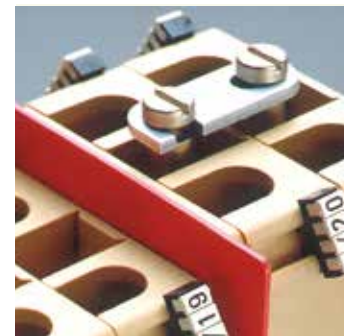

Terminal block	Cross connection		Screw M x l (mm)	Sleeve Ø x l (mm)
	Type	Cat. No.		
CBC.16	POS/53	POS53	4 x 35	5.1 x 30
CBD.2	POS/11	POS11	2.5 x 22	4 x 18
CBD.4	POS/42	POS42	3 x 28	4 x 23
CBD.6	POS/93	POS93	3.5 x 27	5.5 x 21.5
CBD.10	POS/44	POS44	4 x 30	5.5 x 21.5
CBD.16	POS/44	POS44	4 x 30	5.5 x 21.5
CBD.35	POS/66	POS66	4 x 30	8 x 23.5
CBD.50	POS/77	POS77	5 x 30	8 x 23.5
CBD.70	POS/08	POS08	5 x 40	8 x 30
DAS.4	POS/43	POS43	3 x 20	4 x 16
FFS.4	POS/72	POS72	3 x 20	4 x 14.5
FVS.4	POS/72	POS72	3 x 20	4 x 14.5
TLD.2	POS/41	POS41	2.5 x 16	4 x 12.7
TLS.2	POS/41	POS41	2.5 x 16	4 x 12.7
RP.4	POS/43	POS43	3 x 20	4 x 16

Modular test plugs

The modular test plugs make it possible to carry out the final check on terminal boards already wired or a simple derivation.

The tester is positioned directly in the housing of the terminal block like a normal test plug. The extreme simplicity of the modularity makes it possible to assemble the tester in a number of poles according to the various needs.

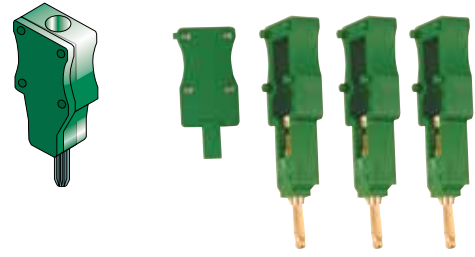

Modular test plugs for screw clamp terminal blocks

- with solder lug

SDD/5 Cat. No. **DD005**

pitch 5.5 mm.
for terminal blocks type CBD.2

SD5/PT Cat. No. **DD501**

closing element for SDD/5

SDD/6 Cat. No. **DD006**

pitch 6.5 mm.
for terminal blocks type CBD.4

SD6/PT Cat. No. **DD601**

closing element for SDD/6

- Screw-clamp

SDC/5 Cat. No. **DC005**

pitch 5 mm.
for terminal blocks type CBC.2/GR

SDC/6 Cat. No. **DC006**

pitch 6 mm.
for terminal blocks type CBC.4/GR

SDC/5P Cat. No. **DC05P**

version to be used with PTC jumper

SDC/6P Cat. No. **DC06P**

version to be used with PTC jumper

SDC/5V Cat. No. **DC05V**

intermediate distancing element

SDC/6V Cat. No. **DC06V**

intermediate distancing element

SDC/POL Cat. No. **DCPOL**

polarising element

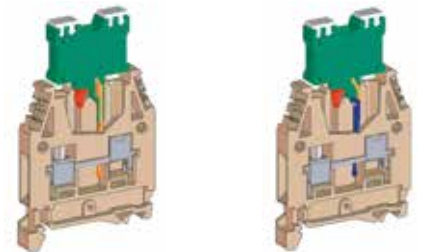
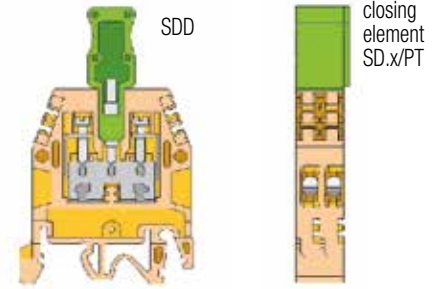

SDC/6 once mounted

SDC/6-P once mounted



SDC/6 with cable composition

Test plugs for spring-clamp terminal blocks

- with solder lug

SDH/4 Cat. No. **DH004**

pitch 4.2 mm
for terminal blocks: HMM.1, HMM.1/1+2, HMM.1/2+2, HMD.1

SDH/4P Cat. No. **DH04P**

version to be used with PTC jumper

SDH/5 Cat. No. **DH005**

pitch 5.2 mm
for terminal blocks HMM.2 - HMM.2/1+2 - HMM.2/2+2 - HMD.2 - HMS.2 - HP.2 Series - HP.2/P

SDH/5P Cat. No. **DH501**

SH4/PT Cat. No. **DH401**

closing element for SDH/4

SDH/6 Cat. No. **DH006**

pitch 6.2 mm
for HMM.4 terminal blocks

SDH/6P Cat. No. **DH601**

SH5/PT Cat. No. **DH501**

closing element for SDH/5

SDH/7 Cat. No. **DH007**

pitch 5.2 mm
for terminal blocks HMD.2N/GR, HMD.2N/X/GR, HMD.2N/X1/GR

SDH/7P Cat. No. **DH07P**

version to be used with PTC jumper

SH6/PT Cat. No. **DH601**

closing element for SDH/6

SH7/PT Cat. No. **DH701**

closing element for SDH/7

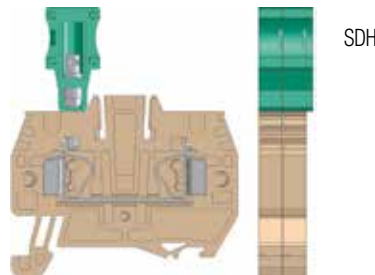

The SDH/5 and SDH/6 test plugs can be combined together.

PSD sockets - SDD plugs

For measurements and checks on circuits which are related to the terminal boards, the following special items can be supplied:

- insulated sockets (**PSD**) screwable onto the conductor body of the terminal blocks.
- plugs (**SDD**) of the bundle type, made of silver-plated brass.

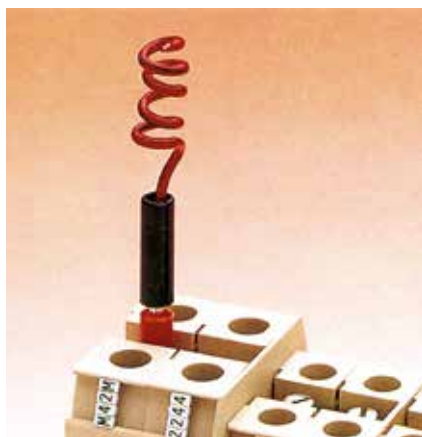
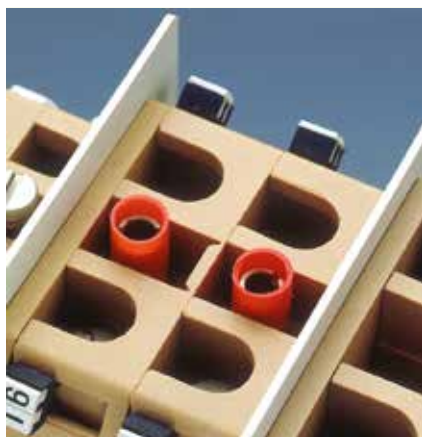

Terminal block	Socket		Internal socket Ø (mm)	Plug		Plug Ø (mm)
	Type	Cat. No.		Type	Cat. No.	
CBC.16	PSD/B	PD002	4.05	SDD/2	DD002	4
CBC.35	PSD/B	PD002	4.05	SDD/2	DD002	4
CBD.2	PSD/D	PD004	2.35	SDD/1	DD001	2.3
CBD.4	PSD/A	PD001	2.35	SDD/1	DD001	2.3
CBD.6	PSD/N	PD013	2.35	SDD/1	DD001	2.3
CBD.10	PSD/B	PD002	4.05	SDD/2	DD002	4
CBD.16	PSD/B	PD002	4.05	SDD/2	DD002	4
CBD.35	PSD/B	PD002	4.05	SDD/2	DD002	4
CBD.50	PSD/C	PD003	4.05	SDD/2	DD002	4
CBD.70	PSD/C	PD003	4.05	SDD/2	DD002	4
CBR.2	PSD/K	PD011	2.35	SDD/1	DD001	2.3
CVF.4	PSD/A	PD001	2.35	SDD/1	DD001	2.3
DAS.4	PSD/A	PD001	2.35	SDD/1	DD001	2.3
FDP.2	-	-	-	SDD/1	DD001	2.3
FFS.4	PSD/A	PD001	2.35	SDD/1	DD001	2.3
FPC.10	-	-	-	SDD/2	DD002	4
FVS.4	PSD/A	PD001	2.35	SDD/1	DD001	2.3
HMD.2	-	-	-	SDD/1	DD001	2.3
HMM.2	-	-	-	SDD/1	DD001	2.3
HMM.2/1+2	-	-	-	SDD/1	DD001	2.3
HMM.2/2+2	-	-	-	SDD/1	DD001	2.3
HMM.2/1+2/S	-	-	-	SDD/1	DD001	2.3
HMM.2/2+2/S	-	-	-	SDD/1	DD001	2.3
HMM.4	-	-	-	SDD/1	DD001	2.3
HMM.4/1+2	-	-	-	SDD/1	DD001	2.3
HMM.4/2+2	-	-	-	SDD/1	DD001	2.3
HMM.6	-	-	-	SDD/1	DD001	2.3
HMM.10	-	-	-	SDD/1	DD001	2.3
HMM.16	-	-	-	SDD/1	DD001	2.3
HMS.2	-	-	-	SDD/1	DD001	2.3
HTE.2	-	-	-	SDD/1	DD001	2.3
HSCB.6	PSD/O	PD017	2.35	SDD/1	DD001	2.3
HTE.2/1+2	-	-	-	SDD/1	DD001	2.3
HTE.2/2+2	-	-	-	SDD/1	DD001	2.3
HTE.4	-	-	-	SDD/1	DD001	2.3
HTE.6	-	-	-	SDD/1	DD001	2.3
HVPC.2	-	-	-	SDD/1	DD001	2.3
MAC.6	-	-	-	SDD/1	DD001	2.3
MPS.2	PSD/K	PD011	2.35	SDD/1	DD001	2.3
NCS	PSD/K	PD011	2.35	SDD/1	DD001	2.3
NCV	PSD/K	PD011	2.35	SDD/1	DD001	2.3
RN.1	PSD/K	PD011	2.35	SDD/1	DD001	2.3
RFI.2	PSD/K	PD011	2.35	SDD/1	DD001	2.3
RN.2	PSD/A	PD001	2.35	SDD/1	DD001	2.3
RP.4	PSD/A	PD001	2.35	SDD/1	DD001	2.3
SCB.4	PSD/A	PD001	2.35	SDD/6-SDD/1	DD006-DD001	2.3
SCB.6	PSD/P	PD015	4.05	SDD/2	DD002	4
SCB.10	PSD/L	PD009	4.05	SDD/2	DD002	4
SFC.10	-	-	-	SDD/2	DD002	4
SFR.4	PSD/J	PD014	2.35	SDD/1	DD001	2.3
TDE.2	PSD/D	PD004	2.35	SDD/1	DD001	2.3
TLD.2	PSD/D	PD004	2.35	SDD/1	DD001	2.3
TLE.2	PSD/D	PD004	2.35	SDD/1	DD001	2.3
TLS.2	PSD/D	PD004	2.35	SDD/1	DD001	2.3

F5 fuses



According to the IEC 60127-2-1- standard with rapid burn-out for voltage 250 V. In small steatite tube filled with spark-quenching powder (interruption power 1500 A).

Burn-out characteristics of the F5 fuses according to DIN 41571 standards

Rated current I_n	Test current			
	1.5 x I_n	2.1 x I_n	4 x I_n	10 x I_n
100 mA – 6.3 A	> 1 h	< 30 min	< 300 ms	< 20 ms

Burn-out characteristics of the F5 fuses according to IEC 127/I and II standards

Rated current I_n	Test current				
	1.5 x I_n	2.1 x I_n	4 x I_n	10 x I_n	10 x I_n
100 mA – 6.3 A	> 1 h	< 30 min	100 ms – 2 s	3 ms – 300 ms	< 20 ms
4 A – 6.3 A	> 1 h	< 30 min	19 ms – 3 s	3 ms – 300 ms	< 20 ms

Rated current	Ø 5 x 20 mm fuse without marking		
	Type	Cat. No.	
100 mA	F5/100 mA	FN001ST	
200 mA	F5/200 mA	FN002ST	
315 mA	F5/315 mA	FN003ST	
500 mA	F5/500 mA	FN004ST	* RINA 5/18/75 homologation - 220V - 50 Hz - 1500 A
630 mA	F5/630 mA	FN005ST	* RINA 5/18/75 homologation - 220V - 50 Hz - 1500 A
1 A	F5/1 A	FN006ST	* RINA 5/18/75 homologation - 220V - 50 Hz - 1500 A
1.6 A	F5/1.6 A	FN007ST	* RINA 5/18/75 homologation - 220V - 50 Hz - 1500 A
2 A	F5/2 A	FN008ST	* RINA 5/18/75 homologation - 220V - 50 Hz - 1500 A
2.5 A	F5/2.5 A	FN009ST	* RINA 5/18/75 homologation - 220V - 50 Hz - 1500 A
3.15 A	F5/3.15 A	FN010ST	* RINA 5/18/75 homologation - 220V - 50 Hz - 1500 A
4 A	F5/4 A	FN011ST	* RINA 5/18/75 homologation - 220V - 50 Hz - 1500 A
5 A	F5/5 A	FN012ST	* RINA 5/18/75 homologation - 220V - 50 Hz - 1500 A
6.3 A	F5/6.3 A	FN013ST	* RINA 5/18/75 homologation - 220V - 50 Hz - 1500 A
8 A	F5/8 A	FN014ST	* RINA 5/18/75 homologation - 220V - 50 Hz - 1500 A
10 A	F5/10 A	FN015ST	* RINA 5/18/75 homologation - 220V - 50 Hz - 1500 A
12 A	F5/12 A	FN016ST	* RINA 5/18/75 homologation - 220V - 50 Hz - 1500 A

LSN torpedo pilot bulbs



Cat. No.	Technical
FL201	Festoon light bulb Ø 6 x 26 mm, with stabiliser resistance incorporated, for voltage between 12 V AC and 48 V AC, for use on FLD.10/F5L, FLD.10/F6, FPL.10 terminal blocks.
FL202	Festoon light bulb Ø 6 x 26 mm, with stabiliser resistance incorporated, for voltage between 70 V AC and 380 V AC, for use on FLD.10/F5L, FLD.10/F6, FPL.10 terminal blocks.
KIT1224	For SFR.6 and SFR.6/M terminal blocks.
KIT70380	For SFR.6 and SFR.6/M terminal blocks.

CIL signal circuit



For signalling the status of fuse-holder terminal blocks types SFR.4 - MAC.6 and FPL.10.

Suitable for use in circuits powered both in D.C. and A.C.

Each packet is supplied with:

- two contact blades
- one non-polarised LED microcircuit
- one transparent protection.

The components are inserted inside the terminal block in this sequence

(* values are to be considered with a tolerance $\pm 10\%$)

Type	Cat. No.	Rated voltage [V DC - V AC]	Current I r.m.s. [A] (*)
CIL/12-48	SF518	12-48	3.0 mA
CIL/115-230	SF510	115-230	2.3 mA

DFU-DFH-DFP partitions

Made of red polyamide, thickness 1.5 mm, to be placed to separate the elements on the terminal board to enable easy identification of certain circuits or to increase the insulation distances between the terminal blocks.

The partitions can also be used to increase the insulation distances between adjacent cross connections or multiple parallel platelets.

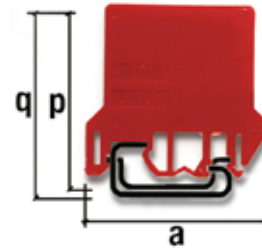

q dimension can be obtained by adding 4 mm to dimension p

NOTE:
q dimension can be obtained by adding 4 mm to dimension p

Terminal block	Partition		Dimensions h x d
	Type	Red code	
Screw-clamp terminal blocks			
AFO.2/1+1	DFU/1/R	DU01R	52 x 51
AFO.2/2+2	DFU/1/R	DU01R	52 x 51
CBC.2	DFU/4/R	DU04R	52 x 62
CBC.4	DFU/4/R	DU04R	52 x 62
CBC.6	DFU/4/R	DU04R	52 x 62
CBC.10	DFU/4/R	DU04R	52 x 62
CBC.16	DFU/4/R	DU04R	52 x 62
CBC.35	DFU/5/R	DU05R	62 x 68
CBD.2	DFU/1/R	DU01R	52 x 51
CBD.4	DFU/4/R	DU04R	52 x 62
CBD.6	DFU/4/R	DU04R	52 x 62
CBD.10	DFU/4/R	DU04R	52 x 62
CBD.16	DFU/4/R	DU04R	52 x 62
CBD.35	DFU/5/R	DU05R	62 x 68
CBD.50	DFU/5/R	DU05R	62 x 68
CBD.70	DFU/6/R	DU06R	72 x 74
CBE.2	DFU/4/R	DU04R	52 x 62
CBR.2	DFU/4/R	DU04R	52 x 62
CVF.4	DFU/3/R	DU03R	68 x 57
DAS.4	DFU/7/R	DU07R	80 x 64
DBC.2	DFU/7/R	DU07R	80 x 64
DSF.4	DFU/7/R	DU07R	80 x 64
DSFA.4	DFU/7/R	DU07R	80 x 64
DSS.4	DFU/7/R	DU07R	80 x 64
FDP.2	DFU/5/R	DU05R	62 x 68
FLD.10/...	DFU/6/R	DU06R	72 x 74
FPC.10	DFU/6/R	DU06R	72 x 74
FPL.10	DFU/6/R	DU06R	72 x 74
FVS.4	DFU/6/R	DU06R	72 x 74
MPFA.4	DFU/3/R	DU03R	68 x 57
NCS	DFU/2/R	DU02R	52 x 54
NCV	DFU/2/R	DU02R	52 x 54
PDF.2	DFU/5/R	DU05R	62 x 68
RFL.2	DFP/2/R	DFP2R	37 x 38
RN.1	DFP/2/R	DFP2R	37 x 38
RN.2	DFP/2/R	DFP2R	37 x 38
RP.4	DFP/2/R	DFP2R	37 x 38
SCB.4	DFU/3/R	DU03R	68 x 57
SCB.6	DFU/6/R	DU06R	72 x 74
SCB.6/DD	DFU/6/R	DU06R	72 x 74
SCB.10	DFU/7/R	DU07R	80 x 64
SCB.10/CD	DFU/7/R	DU07R	80 x 64
SCB.10/DD	DFU/7/R	DU07R	80 x 64

Terminal block	Partition		Dimensions h x d
	Type	Red code	
SCB.6/CD	DFU/6/R	DU06R	72 x 74
SFR.4	DFU/3/R	DU03R	68 x 57
SFR.6	DFU/7/R	DU07R	80 x 64
TC/PO	DFU/1/R	DU01R	52 x 51
TDE.2	DFU/3/R	DU03R	68 x 57
TLD.2	DFU/3/R	DU03R	68 x 57
TLE.2	DFU/3/R	DU03R	68 x 57
TLS.2	DFU/3/R	DU03R	68 x 57
VPC.2	DFU/5/R	DU05R	62 x 68
VPD.2	DFU/7/R	DU07R	80 x 64
Spring-clamp terminal blocks			
HCD.1	DFU/7/R	DU07R	80 x 64
HMD.2	DFH/4/R	DH04R	97 x 51.5
HFR.4	DFH/4/R	DH04R	97 x 51.5
HMFA.2	DFH/2/R	DH02R	76 x 42.5
HMM.2	DFH/1/R	DH01R	64 x 42.5
HMM.2/1+2	DFH/2/R	DH02R	76 x 42.5
HMM.2/2+2	DFH/3/R	DH03R	88 x 42.5
HMM.2/2+2/S	DFH/3/R	DH03R	88 x 42.5
HMM.4	DFH/1/R	DH01R	64 x 42.5
HMM.4/1+2	DFH/4/R	DH04R	97 x 51.5
HMM.4/2+2	DFH/4/R	DH04R	97 x 51.5
HMM.6	DFH/1/R	DH01R	64 x 42.5
HMM.10	DFH/4/R	DH04R	97 x 51.5
HMM.16	DFH/4/R	DH04R	97 x 51.5
HVPC.2	DFH/1/R	DH01R	64 x 42.5
HMS.2	DFH/2/R	DH02R	76 x 42.5
HPP.2	DFP/2/R	DFP2R	37 x 38
HPP.2/P	DFP/2/R	DFP2R	37 x 38
HTE.2	DFH/1/R	DH01R	64 x 42.5
HTE.2/1+1	DFH/2/R	DH02R	76 x 42.5
HTE.2/2+2	DFH/3/R	DH03R	88 x 42.5
HTE.4	DFH/1/R	DH01R	64 x 42.5
HTE.6	DFH/1/R	DH01R	64 x 42.5
HMM.1	DFH/1/R	DH01R	64 x 42.5
HMM.1/1+2	DFH/3/R	DH03R	88 x 42.5
HMM.1/2+2	DFH/2/R	DH02R	76 x 42.5
HMD.1	DFU/7/R	DU07R	80 x 64
HMD.2N	DFU/7/R	DU07R	80 x 64
HMM.2/1+2/S	DFH/2/R	DH02R	76 x 42.5
HSCB.4	DFH/4/R	DH04R	97 x 51.5
HTE.1	DFH/1/R	DH01R	64 x 42.5
HTE.1/1+2	DFH/2/R	DH02R	76 x 42.5
HTE.1/2+2	DFH/3/R	DH03R	88 x 42.5

Partitions

DFM

Made of red **polyamide**, indispensable for **guaranteeing the insulation distance between fixed or switchable cross connections** inserted between adjacent pairs of terminal blocks and, in the same way, between **multiple parallel platelets**, inserted between adjacent groups of terminal blocks.

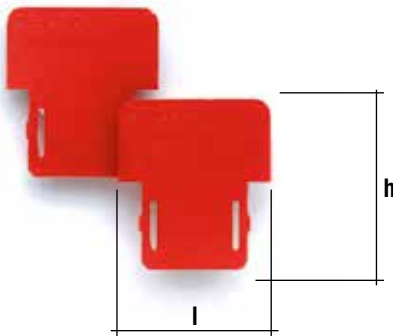

Terminal block	Partition		Dimensions l x h	Thickness mm
	Type	Cat. No.		
CBC.2	DFM/900	DF900	17 x 18	0.5
	DFM/800	DF800	11 x 18	0.5
CBC.4	DFM/900	DF900	17 x 18	0.5
	DFM/800	DF800	11 x 18	0.5
CBC.6	DFM/900	DF900	17 x 18	0.5
	DFM/800	DF800	11 x 18	0.5
CBC.10	DFM/900	DF900	17 x 18	0.5
	DFM/800	DF800	11 x 18	0.5
CBC.16	DFM/700	DF700	28 x 32	0.5
CBC.35	DFM/700	DF700	28 x 32	0.5
CBD.2	DFM/600	DF600	24 x 31	0.5
	DFM/600	DF600	24 x 31	0.5
CBD.4	DFM/600	DF600	24 x 31	0.5
	DFM/600	DF600	24 x 31	0.5
CBD.6	DFM/600	DF600	24 x 31	0.5
	DFM/600	DF600	24 x 31	0.5
CBD.10	DFM/700	DF700	28 x 32	0.5
	DFM/700	DF700	28 x 32	0.5
CBD.16	DFM/700	DF700	28 x 32	0.5
	DFM/700	DF700	28 x 32	0.5
CBD.35	DFM/700	DF700	28 x 32	0.5
	DFM/700	DF700	28 x 32	0.5
CBD.50	DFM/700	DF700	28 x 32	0.5
	DFM/700	DF700	28 x 32	0.5
CBD.70	DFM/700	DF700	28 x 32	0.5
	DFM/700	DF700	28 x 32	0.5
DBC.2	DFM/900	DF900	17 x 18	0.5
	DFM/800	DF800	17 x 18	0.5
DSS.4	DFM/500	DF500	4.6 x 13.5	0.5
	DFM/500	DF500	4.6 x 13.5	0.5
DSFA.4	DFM/500	DF500	4.6 x 13.5	0.5
HDE.2	DFM/500	DF500	4.6x13.5	0.5
HLD.2	DFM/500	DF500	4.6x13.5	0.5
HMM.1	DFM/500	DF500	4.6 x 13.5	0.5
HMM.1/1+2	DFM/500	DF500	4.6 x 13.5	0.5
HMM.1/2+2	DFM/500	DF500	4.6 x 13.5	0.5
HMD.1	DFM/500	DF500	4.6 x 13.5	0.5
HMD.2/N	DFM/500	DF500	4.6 x 13.5	0.5
MPS.4	DFM/500	DF500	4.6 x 13.5	0.5
MPFA.4	DFM/500	DF500	4.6 x 13.5	0.5
TLD.2	DFM/400	DF400	10 x 18	0.5
TLS.2	DFM/400	DF400	10 x 18	0.5
VPC.2	DFM/300	DF300	9.4 x 12.9	0.4
VPD.2	DFM/300	DF300	9.4 x 12.9	0.4

Protection covers

PRT covers / SPS supports



(*) height including rail

For protecting from accidental contacts or tampering **CDA** and **ACB** Series terminal blocks. Made of self-extinguishing and transparent material of thickness 2.3 mm and fixed length 200 mm (corresponding to the total width of the four terminal blocks side-by-side). The covers are available in three sizes:

PRT/P 22 x 125 mm (Cat.No. PRT01)
- for protecting ACB/BB terminal blocks

PRT/M 50 x 125 mm (Cat.No. PRT02)
- for protecting ACB/CC terminal blocks

PRT/G 85 x 125 mm (Cat.No. PRT03)
- to be used when the conductors come from the backboard, or in order to protect a connection point not yet connected.

The PRT covers must be inserted on **SPS supports**, made of self-extinguishing ABS / class UL94V-0, thickness 5 mm, interposed between contiguous terminal blocks. Protection of the four terminal blocks side-by-side is achieved by means of overlapping coupling of **two** PRTs.

Note: The ID Cat. No. (i.e. PRT01) is **referred** to a single item.

PZM protection covers and PZD supports

Made of **PVC** for protecting from accidental contacts or tampering terminal blocks up to a section of 70 mm².

They are supplied in 2 m lengths and are to be mounted on specific polyamide supports, insertable on PR/DIN and PR/3 support rails, types "G32" and TH/35.

They can be made unmovable with sealing of the support appendices.

PZM.4 cover (a = 64+2 mm / b = 32 mm)

Cat. No. **PZ330**

For terminal blocks **of size up to approximately 58 mm** (including rail).

To be mounted with **PZD.4/SO supports** (Cat. No. PZ331)

Maximum size PZM.4 + PZD.4/SO

- on rail IEC 60715/G32 = 70 or 82 mm (*)

- on rail IEC 60715/TH35 = 65 or 77 mm (*)

(*) depending on the notches used, upper or lower.

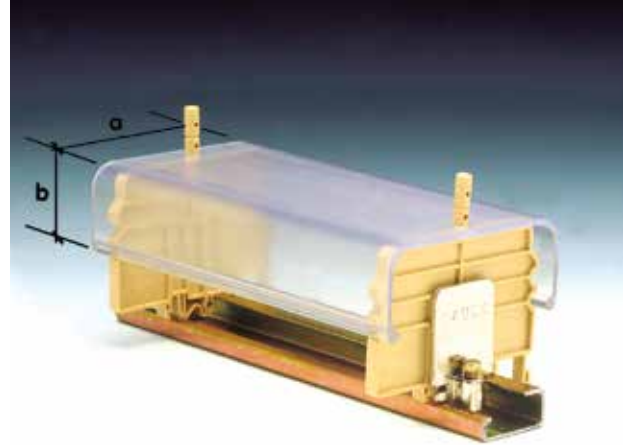

PZM.4 - PZM.6 channel

PZM.6 cover (a = 85+2 mm / b = 36 mm)

Cat. No. **PZ110**

For terminal blocks **of size of more than approximately 58 mm** (including rail).

To be mounted with **PZD.6/SO supports** (Cat. No. PZ112)

Maximum size PZM.6 + PZD.6/SO

- on rail IEC 60715/G32 = 82 or 94 mm (*)

- on rail IEC 60715/TH35 = 78 or 90 mm (*)

(*) depending on the notches used, upper or lower.

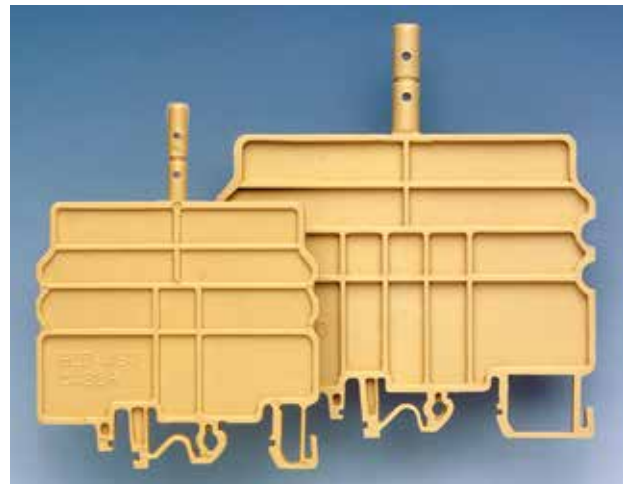

PZD.4/SO - PZD.6/SO supports

PRP Protections

The cross connection, made up of the PMP multiple commoning bar and CPM screws and sleeves, already located in a position further back with respect to the front of the terminal board, can be further protected against accidental contacts, by means of a U-shaped cover, made of polyamide, with a standard length of 10 cm. The above protection, which is white, can also be used to write words or make reference markings of the terminal board. Special slots are provided on the protection to make it easy to remove using a screwdriver.

for terminal blocks of cross section 2.5-4 mm² **PRP/6**

Cat. No.
PRP06

for terminal blocks of cross section 4-16 mm² **PRP/7**

Cat. No.
PRP07

for terminal blocks of cross section 25-70 mm² **PRP/8**

Cat. No.
PRP08

for TLD.2-TLS.2-CBR.2-DAS.4-TLE.2-TDE.2 terminal blocks

PRP/5
(red, blue, white)

Cat. No.
PRP05

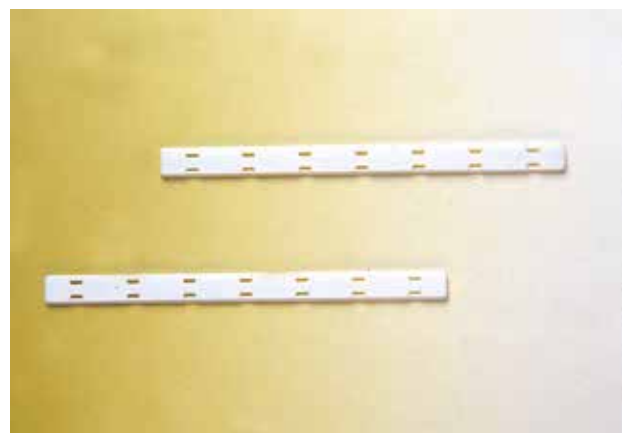

PRP Protections

Warning plates

TQM-TTM-TUM-PRP/7/G

Made of self-extinguishing material, capable of guarantee the maximum safety of work on terminal boards connected to circuits that are always live.

Bearing warning signals and notices, fixable to the terminal blocks by means of two nylon insulating screws, they are available in models of different sizes, according to the type of terminal block.

The cover can be tripolar or quadripolar; in some cases the tripolar is made removing a pre-cut part of the quadripolar cover

For CBC. 2-4-6-10 terminal blocks the PRP/7/G is supplied; this is without screws, to be inserted in the channels of the cross connections.



Terminal block	Warning plate for 3 terminal blocks		l x h mm	Warning plate for 4 terminal blocks		l x h mm	Screw M x l (mm)
	Type	Cat. No.		Type	Cat. No.		
CBC.2	PRP/7/G (*)	PRP070G	l = 100	PRP/7/G (*)	PRP070G	100	-
CBC.4	PRP/7/G (*)	PRP070G	l = 100	PRP/7/G (*)	PRP070G	100	-
CBC.6	PRP/7/G (*)	PRP070G	l = 100	PRP/7/G (*)	PRP070G	100	-
CBC.10	PRP/7/G (*)	PRP070G	l = 100	PRP/7/G (*)	PRP070G	100	-
CBC.16	TUM/16	TUM16	48 x 34	TUM/16	TUM16	48 x 34	4 x 30
CBC.35	TUM/06	TUM06	63 x 34	TUM/06	TUM06	63 x 34	4 x 30
CBD.2	-	-	-	TQM/02	TQM02	25 x 26	2.5 x 20
CBD.4	TTM/12	TTM12	25 x 26	TTM/12	TTM12	25 x 26	3 x 25
CBD.6	TTM/15	TTM15	25 x 26	TQM/15	TQM15	32 x 26	3.5 x 25
CBD.10	TTM/04	TTM04	32 x 26	TQM/04	TQM04	40 x 26	4 x 25
CBD.16	TUM/05	TUM05	48 x 34	TUM/05	TUM05	48 x 34	4 x 25
CBD.35	TUM/06	TUM06	63 x 34	TUM/06	TUM06	63 x 34	4 x 30
CBD.50	TUM/07	TUM07	72 x 42	TUM/07	TUM07	72 x 42	5 x 30
CBD.70	TUM/08	TUM08	82 x 42	TUM/08	TUM08	82 x 42	5 x 40
EDM.2	-	-	-	TQM/02	TQM02	25 x 26	2.5 x 20
EDM.4	TTM/12	TTM12	25 x 26	TTM/12	TTM12	25 x 26	3 x 25
EDM.6	TTM/15	TTM15	25 x 26	TQM/15	TQM15	32 x 26	3.5 x 25
EDM.10	-	-	-	TQM/04	TQM04	40 x 26	4 x 25
EDM.16	TUM/05	TUM05	48 x 34	TUM/05	TUM05	48 x 34	4 x 25
EDM.25	TUM/06	TUM06	63 x 34	TUM/06	TUM06	63 x 34	4 x 30
EDM.35	TUM/07	TUM07	72 x 42	TUM/07	TUM07	72 x 42	5 x 30
EDM.70	TUM/08	TUM08	82 x 42	TUM/08	TUM08	82 x 42	5 x 40
SV.2	-	-	-	TQM/02	TQM02	25 x 26	2.5 x 20
SV.4	TTM/12	TTM12	25 x 26	TQM/12	TQM12	40 x 26	3.5 x 30
SV.6	TTM/13	TTM13	25 x 26	TQM/13	TQM13	25 x 26	2.5 x 20
SV.10	TTM/14	TTM14	32 x 26	TQM/14	TQM14	25 x 26	3 x 15

(*) to be cut to size



TAI

Possible danger status may be marked using **special triangular self-adhesive labels**

TAI/6 (Cat. No. TA001)

TAI/12 (Cat. No. TA002)

to be applied on the protection covers and channels.

MSM handle

For simultaneous switching of several FPL.10 and SFL.10 terminal blocks side-by-side. Supplied in strips of 6 elements.

MSM (Cat. No. FC103)

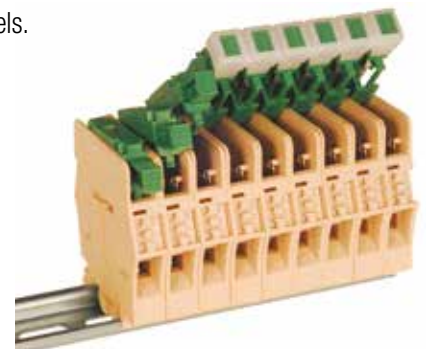

Tag holder

- Possibility of marking 2- and 3-level terminal blocks
- High visibility of the marking
- Available in the 2- and 3-tag version
- Reduced vertical size thanks to high flexibility
- Compatible with all the 2- and 3-level terminal blocks
- Available in grey



grey version	TH/2	TH/3																												
	Cat. No. TH02	Cat. No. TH03																												
TECHNICAL CHARACTERISTICS																														
function/type	tag holder	tag holder																												
vertical size	19 mm	21 mm																												
width	18 mm	29 mm																												
thickness	4.7 mm	4.7 mm																												
	<table border="1"> <thead> <tr> <th>Type</th> <th>Cat. No.</th> </tr> </thead> <tbody> <tr> <td>C/NU/8/51</td> <td>NU0851</td> </tr> <tr> <td>C/NU/8/61</td> <td>NU0861</td> </tr> <tr> <td>C/NU/10/51</td> <td>NU1051</td> </tr> <tr> <td>C/NU/10/61</td> <td>NU1061</td> </tr> <tr> <td>C/NU/10/55</td> <td>NU1055</td> </tr> <tr> <td>C/NU/10/65</td> <td>NU1065</td> </tr> </tbody> </table>	Type	Cat. No.	C/NU/8/51	NU0851	C/NU/8/61	NU0861	C/NU/10/51	NU1051	C/NU/10/61	NU1061	C/NU/10/55	NU1055	C/NU/10/65	NU1065	<table border="1"> <thead> <tr> <th>Type</th> <th>Cat. No.</th> </tr> </thead> <tbody> <tr> <td>C/NU/8/51</td> <td>NU0851</td> </tr> <tr> <td>C/NU/8/61</td> <td>NU0861</td> </tr> <tr> <td>C/NU/10/51</td> <td>NU1051</td> </tr> <tr> <td>C/NU/10/61</td> <td>NU1061</td> </tr> <tr> <td>C/NU/10/55</td> <td>NU1055</td> </tr> <tr> <td>C/NU/10/65</td> <td>NU1065</td> </tr> </tbody> </table>	Type	Cat. No.	C/NU/8/51	NU0851	C/NU/8/61	NU0861	C/NU/10/51	NU1051	C/NU/10/61	NU1061	C/NU/10/55	NU1055	C/NU/10/65	NU1065
Type	Cat. No.																													
C/NU/8/51	NU0851																													
C/NU/8/61	NU0861																													
C/NU/10/51	NU1051																													
C/NU/10/61	NU1061																													
C/NU/10/55	NU1055																													
C/NU/10/65	NU1065																													
Type	Cat. No.																													
C/NU/8/51	NU0851																													
C/NU/8/61	NU0861																													
C/NU/10/51	NU1051																													
C/NU/10/61	NU1061																													
C/NU/10/55	NU1055																													
C/NU/10/65	NU1065																													
Identification cards usable																														
quantity per pack	50 pieces	50 pieces																												

With use of the TH/2 and TH/3 supports it is possible to increase the space available for marking on all the Cabur terminal blocks (*), and avoid the difficulties of identifying the conductors in multi-level terminal blocks.

*TH/2 and TH/3 are not compatible with the terminal blocks of the HPP and HPC Series grey version

Speed Rail

Windows™ application for terminal blocks for rails and panels type SWSR1.0 - Cat. No. SWSR1

- intuitive interface
- computer-assisted design
- 3D display
- no CAD platform required
- automatic creation of the Bill of Materials in table format and Adobe® Acrobat® PDF
- option to request an estimate with a single click
- trial version can be downloaded from the website
- licensed for installation on 5 PCs

Speed Rail is a software application designed to simplify and speed up the construction of a terminal board using Cabur terminal blocks.

Thanks to the **intuitive interface** and the **graphic elements**, Speed Rail is easy to use and does not require specialist computer skills; furthermore, the software guides and assists you throughout every stage of the terminal board's design:

- automatically removes and adds end sections as needed to protect uncovered contacts or places them where insulation needs to be maintained;
- automatically includes cross-connection barriers between adjacent connections;
- reports the danger of short-circuit and suggests positioning an end section or cross-connection barrier;
- arranges connections in the best possible way to ensure maximum insulation.

Speed Rail helps you **plan** your terminal board **quickly and efficiently**, starting from the holes in the mounting rail and the arrangement of supports, through to inserting terminal blocks, marking, creating connections between terminal blocks, adding the protection cover, covering each and every detail even up to inserting modular test plugs and derivation socket plugs.

Thanks to the **3D visualization**, you can see your terminal board from every angle, as if it were in your hands, and watch every phase of its development.

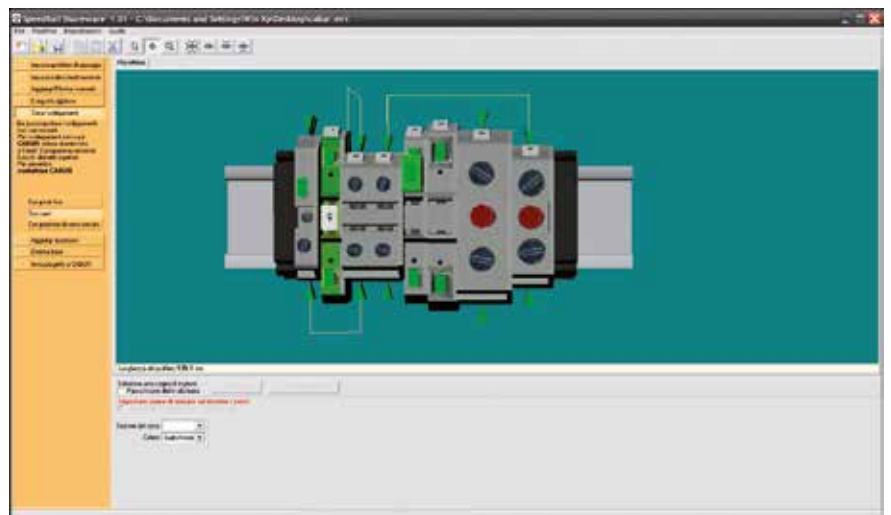
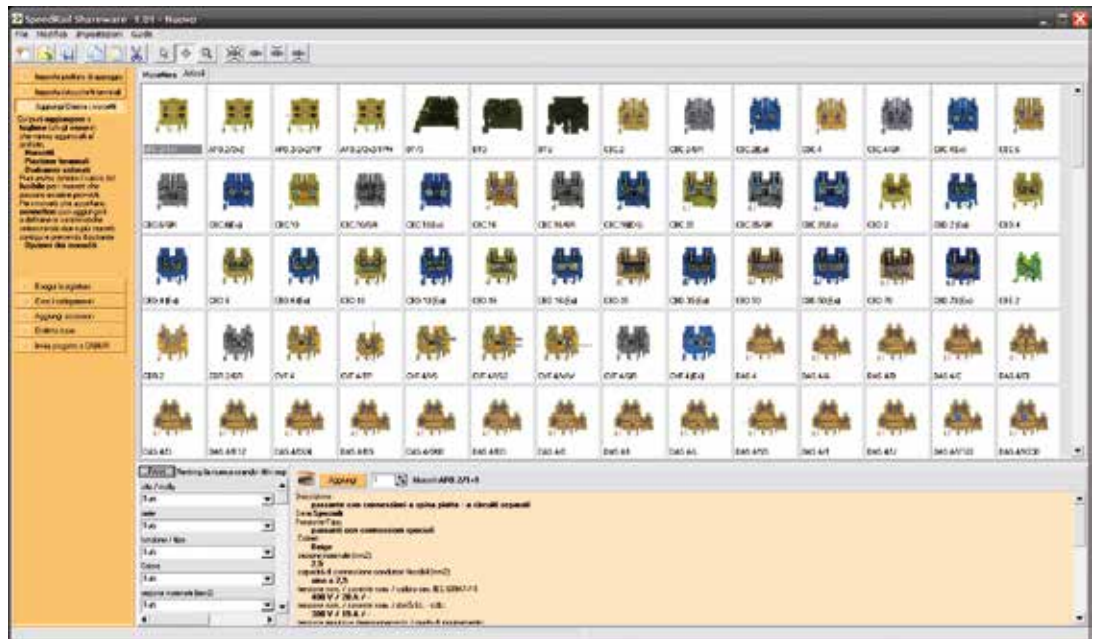
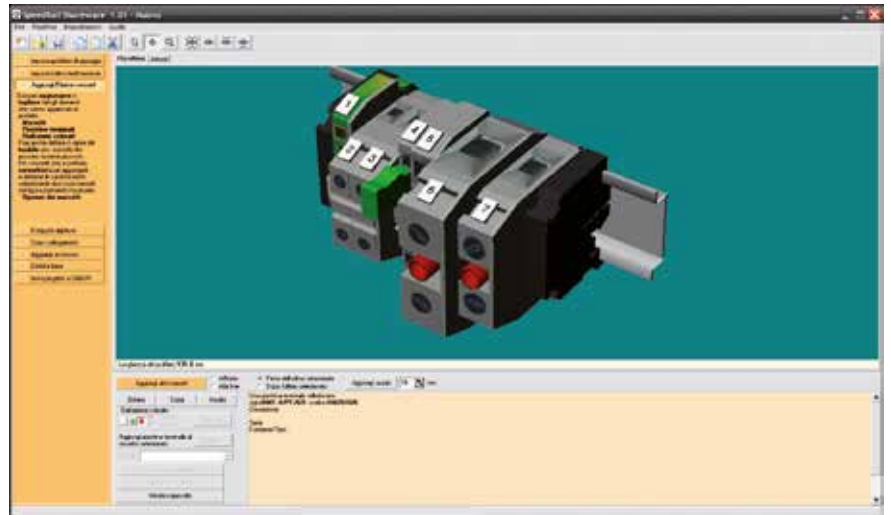

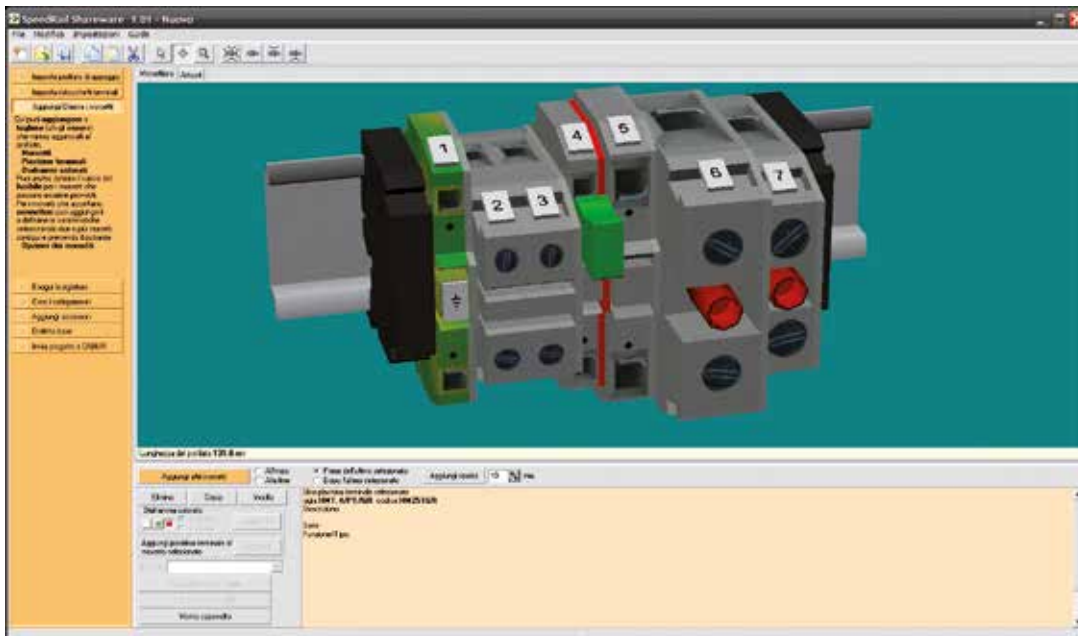
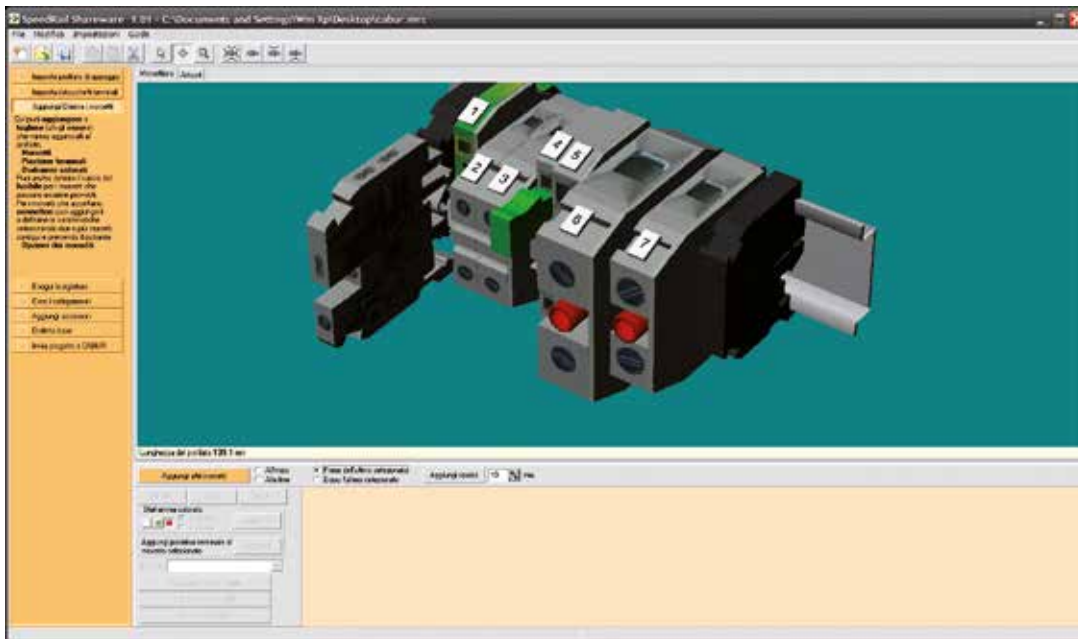

Quantità	Prezzo unit.	Prezzo net.	Sign.	Codice	Descrizione
5	0.0000	0.0000	4	44000110	MORSETTO DI RINGHIA
5	0.0000	0.0000	3	33000011	MORSETTO PRESSANTE
5	0.0000	0.0000	3	33000012	MORSETTO PRESSANTE
5	0.0000	0.0000	3	33000013	MORSETTO PRESSANTE
10	0.0000	0.0000	3	33000014	MORSETTO PRESSANTE
5	0.0000	0.0000	3	33000015	MORSETTO PRESSANTE
5	0.0000	0.0000	3	33000016	MORSETTO PRESSANTE
5	0.0000	0.0000	3	33000017	MORSETTO PRESSANTE
5	0.0000	0.0000	3	33000018	MORSETTO PRESSANTE
5	0.0000	0.0000	3	33000019	MORSETTO PRESSANTE
5	0.0000	0.0000	3	33000020	MORSETTO PRESSANTE
5	0.0000	0.0000	3	33000021	MORSETTO PRESSANTE
5	0.0000	0.0000	3	33000022	MORSETTO PRESSANTE
5	0.0000	0.0000	3	33000023	MORSETTO PRESSANTE
5	0.0000	0.0000	3	33000024	MORSETTO PRESSANTE
5	0.0000	0.0000	3	33000025	MORSETTO PRESSANTE
5	0.0000	0.0000	3	33000026	MORSETTO PRESSANTE
5	0.0000	0.0000	3	33000027	MORSETTO PRESSANTE
5	0.0000	0.0000	3	33000028	MORSETTO PRESSANTE
5	0.0000	0.0000	3	33000029	MORSETTO PRESSANTE
5	0.0000	0.0000	3	33000030	MORSETTO PRESSANTE
5	0.0000	0.0000	3	33000031	MORSETTO PRESSANTE
5	0.0000	0.0000	3	33000032	MORSETTO PRESSANTE
5	0.0000	0.0000	3	33000033	MORSETTO PRESSANTE
5	0.0000	0.0000	3	33000034	MORSETTO PRESSANTE
5	0.0000	0.0000	3	33000035	MORSETTO PRESSANTE
5	0.0000	0.0000	3	33000036	MORSETTO PRESSANTE
5	0.0000	0.0000	3	33000037	MORSETTO PRESSANTE
5	0.0000	0.0000	3	33000038	MORSETTO PRESSANTE
5	0.0000	0.0000	3	33000039	MORSETTO PRESSANTE
5	0.0000	0.0000	3	33000040	MORSETTO PRESSANTE
5	0.0000	0.0000	3	33000041	MORSETTO PRESSANTE
5	0.0000	0.0000	3	33000042	MORSETTO PRESSANTE
5	0.0000	0.0000	3	33000043	MORSETTO PRESSANTE
5	0.0000	0.0000	3	33000044	MORSETTO PRESSANTE
5	0.0000	0.0000	3	33000045	MORSETTO PRESSANTE
5	0.0000	0.0000	3	33000046	MORSETTO PRESSANTE
5	0.0000	0.0000	3	33000047	MORSETTO PRESSANTE
5	0.0000	0.0000	3	33000048	MORSETTO PRESSANTE
5	0.0000	0.0000	3	33000049	MORSETTO PRESSANTE
5	0.0000	0.0000	3	33000050	MORSETTO PRESSANTE
5	0.0000	0.0000	3	33000051	MORSETTO PRESSANTE
5	0.0000	0.0000	3	33000052	MORSETTO PRESSANTE
5	0.0000	0.0000	3	33000053	MORSETTO PRESSANTE
5	0.0000	0.0000	3	33000054	MORSETTO PRESSANTE
5	0.0000	0.0000	3	33000055	MORSETTO PRESSANTE
5	0.0000	0.0000	3	33000056	MORSETTO PRESSANTE
5	0.0000	0.0000	3	33000057	MORSETTO PRESSANTE
5	0.0000	0.0000	3	33000058	MORSETTO PRESSANTE
5	0.0000	0.0000	3	33000059	MORSETTO PRESSANTE
5	0.0000	0.0000	3	33000060	MORSETTO PRESSANTE
5	0.0000	0.0000	3	33000061	MORSETTO PRESSANTE
5	0.0000	0.0000	3	33000062	MORSETTO PRESSANTE
5	0.0000	0.0000	3	33000063	MORSETTO PRESSANTE
5	0.0000	0.0000	3	33000064	MORSETTO PRESSANTE
5	0.0000	0.0000	3	33000065	MORSETTO PRESSANTE
5	0.0000	0.0000	3	33000066	MORSETTO PRESSANTE
5	0.0000	0.0000	3	33000067	MORSETTO PRESSANTE
5	0.0000	0.0000	3	33000068	MORSETTO PRESSANTE
5	0.0000	0.0000	3	33000069	MORSETTO PRESSANTE
5	0.0000	0.0000	3	33000070	MORSETTO PRESSANTE
5	0.0000	0.0000	3	33000071	MORSETTO PRESSANTE
5	0.0000	0.0000	3	33000072	MORSETTO PRESSANTE
5	0.0000	0.0000	3	33000073	MORSETTO PRESSANTE
5	0.0000	0.0000	3	33000074	MORSETTO PRESSANTE
5	0.0000	0.0000	3	33000075	MORSETTO PRESSANTE
5	0.0000	0.0000	3	33000076	MORSETTO PRESSANTE
5	0.0000	0.0000	3	33000077	MORSETTO PRESSANTE
5	0.0000	0.0000	3	33000078	MORSETTO PRESSANTE
5	0.0000	0.0000	3	33000079	MORSETTO PRESSANTE
5	0.0000	0.0000	3	33000080	MORSETTO PRESSANTE
5	0.0000	0.0000	3	33000081	MORSETTO PRESSANTE
5	0.0000	0.0000	3	33000082	MORSETTO PRESSANTE
5	0.0000	0.0000	3	33000083	MORSETTO PRESSANTE
5	0.0000	0.0000	3	33000084	MORSETTO PRESSANTE
5	0.0000	0.0000	3	33000085	MORSETTO PRESSANTE
5	0.0000	0.0000	3	33000086	MORSETTO PRESSANTE
5	0.0000	0.0000	3	33000087	MORSETTO PRESSANTE
5	0.0000	0.0000	3	33000088	MORSETTO PRESSANTE
5	0.0000	0.0000	3	33000089	MORSETTO PRESSANTE
5	0.0000	0.0000	3	33000090	MORSETTO PRESSANTE
5	0.0000	0.0000	3	33000091	MORSETTO PRESSANTE
5	0.0000	0.0000	3	33000092	MORSETTO PRESSANTE
5	0.0000	0.0000	3	33000093	MORSETTO PRESSANTE
5	0.0000	0.0000	3	33000094	MORSETTO PRESSANTE
5	0.0000	0.0000	3	33000095	MORSETTO PRESSANTE
5	0.0000	0.0000	3	33000096	MORSETTO PRESSANTE
5	0.0000	0.0000	3	33000097	MORSETTO PRESSANTE
5	0.0000	0.0000	3	33000098	MORSETTO PRESSANTE
5	0.0000	0.0000	3	33000099	MORSETTO PRESSANTE
5	0.0000	0.0000	3	33000100	MORSETTO PRESSANTE

You can easily choose the terminal blocks best suited to your requirements, thanks to the technical data integrated into the software. Once you have identified the terminal blocks, Speed Rail will guide you through the choice of accessories, saving you time from searching for codes and verifying compatibility in catalogues.

Once all the details have been defined, Speed Rail will **automatically produce a bill of materials** in PDF format – even specifying the details and characteristics of the accessories, the marking, the terminal blocks used and the support mounting rail arrangements. You will be able to **request an estimate immediately** for the products needed and/or the terminal board assembly service.

A **trial version**, valid for 30 days, for complete, effective use of the software can be downloaded free of charge from the website **www.cabur.eu** Please note the following limitations:

- trial period limited to 30 days of effective use for a maximum of 90 days as from the date of installation
- on-line updates are disabled

Technical requirements for installation:

Platform: PC with Microsoft® Windows™ XP or later operating system.
 Min. 512 MB RAM.
 Hard disk space: 50 MB for basic installation, 155 MB for full installation (inc. video tutorials for software use).
 Video viewer: Microsoft® Windows™ Media Player or compatible.

Marking systems

Cabur offers a complete line of products capable of meeting the multiple needs in the field of industrial marking.

The CaburJet printers are characterised by a small size to reduce bulk and by an innovative design, aimed at making them fast and easy to use, with no maintenance problems in any application context.

The series of products for industrial marking includes the printer with thermal transfer technology Smart Print and Smart Roll, designed for rapid marking, and the inkjet printer CaburJet, fitted with an automatic loader for high print volumes.

Cabur proposes a vast choice of consumable products designed to optimise the efficiency of marking in all its aspects and to create markings of excellent quality and long lasting.

THERMAL TRANSFER PRINTERS

SmartPrint

TECHNICAL DATA	
Technology for	thermal transfer
Interface	USB 2.0
Resolution	300 dpi
Print Speed	Up to 19 mm/sec
Windows support	PC systems/from Windows XP to Windows 10
Display	LCD
Dimensions (DxLxH)	400 x 230 x 280 mm
Weight	approx. 8 Kg.
External power supply	100 - 240 VAC
Working temperature	10-34°C
Ribbon	monochromatic resin based
Ribbon colours	black, blue, red, green



SmartRoll

TECHNICAL DATA	
Technology for	thermal transfer
Interface	USB 2.0
Resolution	300 dpi
Print Speed	Up to 152 mm/sec
Windows support	PC systems/from Windows XP to Windows 10
Dimensions (DxLxH)	505 x 270 x 308mm
Weight	approx. 15 Kg.
Power supply voltage	100 - 240 VAC
Working temperature	5-40°C
Ribbon	monochromatic resin based
Ribbon colours	black, red



INKJET PRINTER

CaburJet

TECHNICAL DATA	
Technology for	monochromatic inkjet printing
Interface	USB 2.0
Resolution	360 Dpi
Ink	refillable bottles
Print Speed	24,000 tags / 1 hour
Windows support	for PC systems with Windows 98 SP2 and later
Dimensions (DxLxH)	370 x 330 x 220 mm
Weight	approx. 12 Kg.
Power	during printing, 24W max. with compressor on, 35W
Power supply voltage	115-230V



MARKING PRO XT

Marking Pro XT is a software for printing characters and images on tags and cards. It can be used with the Smart Print and Smart Roll printers. The programme joins the existing MarKing Pro, the software suitable for managing CaburJet and all the Plotters most common on the market. MarKing Pro XT allows direct extraction of data from Excel, csv, txt etc. files and supports the Unicode format.

Thanks to its intuitive interface and visual elements, MarKing Pro XT is easy to use, and enables previewing of the end result before printing. Cabur offers a marking service, which can be provided on the basis of files created in MarKing Pro XT by the customer. Send Cabur your MarKing Pro XT files to receive a quotation and service that provides the utmost in efficiency and guarantees reliable results.



Pre-printed tags for Cabur terminal blocks

CNU/8/51 for HORIZONTAL AND VERTICAL printing

- Marking tags suitable for marking all types of terminal blocks (screw-clamp and spring-clamp) in cards of 100 elements in packs of 500 tags.
- In white polycarbonate with black printing, to be applied directly into position either before or after preparing the terminal block.
- **Tag dimensions: 8 x 5.1 mm. Pitch on CBC.2 and HMM.2/GR.**
- **Mounting of single tag on all Cabur terminal blocks.**



CAT. NO. TAGS WITH VERTICAL NUMBERS	CAT. NO. TAGS WITH HORIZONTAL NUMBERS	DESCRIPTION	TAGS PER PACK
NU0851	NU0851	CNU/8/030 100 TAGS BLANK	1,500
NU0851001V	NU0851001	CNU/8/001 TAG. NO. 1 to 50	500
NU0851010V	NU0851010	CNU/8/010 100 TAG. NO. 10	500
NU0851011V	NU0851011	CNU/8/11 TAG. NO. 11	500
NU0851012V	NU0851012	CNU/8/12 100 TAGS. 12	500
NU0851013V	NU0851013	CNU/8/13 TAG. NO. 13	500
NU0851014V	NU0851014	CNU/8/14 TAG. NO. 14	500
NU0851015V	NU0851015	CNU/8/15 TAG. NO. 15	500
NU0851016V	NU0851016	CNU/8/16 TAG. NO. 16	500
NU0851017V	NU0851017	CNU/8/17 TAG. NO. 17	500
NU0851018V	NU0851018	CNU/8/18 TAG. NO. 18	500
NU0851019V	NU0851019	CNU/8/19 TAG. NO. 19	500
NU0851020V	NU0851020	CNU/8/20 TAG. NO. 20	500
NU085102AV	NU085102A	CNU/8/2A TAGS. MARKED 2A	500
NU0851051V	NU0851051	CNU/8/051 TAGS from 51 to 100	500
NU08510L1V	NU08510L1	CNU/8/L1 TAGS. MARKED L1	500
NU08510L2V	NU08510L2	CNU/8/L2 TAGS. MARKED L2	500
NU08510L3V	NU08510L3	CNU/8/L3 TAGS. MARKED L3	500
NU08510NIV	NU08510NI	CNU/8/NI TAGS. MARKED NI	500
NU08510PEV	NU08510PE	CNU/8/PE TAGS. MARKED PE	500
NU08510R1V	NU08510R1	CNU/8/R1 TAGS. MARKED R1	500
NU08510S1V	NU08510S1	CNU/8/S1 TAGS. MARKED S1	500
NU08510S2V	NU08510S2	CNU/8/S2 TAGS. MARKED S2	500
NU08510S3V	NU08510S3	CNU/8/S3 TAGS. MARKED S3	500
NU08510U1V	NU08510U1	CNU/8/U1 TAGS. MARKED U1	500
NU08510U2V	NU08510U2	CNU/8/U2 TAGS. MARKED U2	500
NU08510V	NU08510	CNU/8/000 TAGS 0	500
NU08510V1V	NU08510V1	CNU/8/V1 TAGS. MARKED V1	500
NU08510V2V	NU08510V2	CNU/8/V2 TAGS. MARKED V2	500
NU08510W1V	NU08510W1	CNU/8/W1 TAGS. MARKED W1	500
NU08510W2V	NU08510W2	CNU/8/W2 TAGS. MARKED W2	500
NU0851101V	NU0851101	CNU/8/101 TAGS. from 101 to 150	500
NU085110V	NU085110	CNU/8/025 100 TAGS =	500
NU085111V	NU085111	CNU/8/023 100 TAGS +	500
NU085112V	NU085112	CNU/8/024 100 TAGS -	500
NU085114V	NU085114	CNU/8/027 TAGS EARTH	500
NU0851151V	NU0851151	CNU/8/151 TAGS from 151 to 200	500
NU085115V	NU085115	CNU/8/028 TAG EARTH CIRCLE	500
NU08511V	NU08511	CNU/8/111 100 TAGS 1	500
NU0851201V	NU0851201	CNU/8/201 TAGS from 201 to 250	500
NU0851251V	NU0851251	CNU/8/251 TAGS from 251 to 300	500
NU08512V	NU08512	CNU/8/222 100 TAGS 2	500
NU0851301V	NU0851301	CNU/8/301 TAGS from 301 to 350	500
NU0851351V	NU0851351	CNU/8/351 TAGS from 351 to 400	500
NU08513V	NU08513	CNU/8/333 100 TAGS 3	500
NU0851401V	NU0851401	CNU/8/401 TAGS from 401 to 450	500
NU0851451V	NU0851451	CNU/8/451 TAGS from 451 to 500	500
NU08514V	NU08514	CNU/8/444 100 TAGS 4	500
NU0851501V	NU0851501	CNU/8/501 TAGS from 501 to 550	500

Writing type

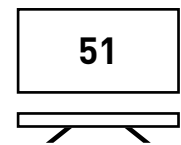

HORIZONTAL

Writing type

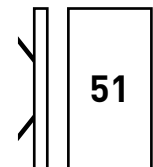

VERTICAL

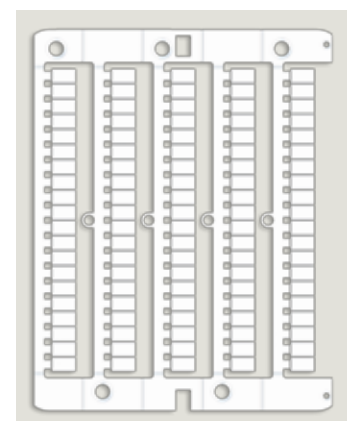

Card CNU/8/51
Cat. No. NU0851

Pre-printed tags for Cabur terminal blocks

CNU/8/51 for HORIZONTAL AND VERTICAL printing

- Marking tags suitable for marking all types of terminal blocks (screw-clamp and spring-clamp) in cards of 100 elements in packs of 500 tags.
- In white polycarbonate with black printing, to be applied directly into position either before or after preparing the terminal block.
- **Tag dimensions: 8 x 5.1 mm. Pitch on CBC.2 and HMM.2/GR.**
- **Mounting of single tag on all Cabur terminal blocks.**

CAT. NO. TAGS WITH VERTICAL NUMBERS	CAT. NO. TAGS WITH HORIZONTAL NUMBERS	DESCRIPTION	QUANTITY PER PK
NU0851510V	NU0851510	CNU/8/510 TAGS from 1 to 10	500
NU0851520V	NU0851520	CNU/8/520 TAGS from 11 to 20	500
NU0851530V	NU0851530	CNU/8/530 TAGS from 21 to 30	500
NU0851540V	NU0851540	CNU/8/540 TAGS from 31 to 40	500
NU0851550V	NU0851550	CNU/8/550 TAGS from 41 to 50	500
NU0851551V	NU0851551	CNU/8/551 TAGS from 551 to 600	500
NU0851560V	NU0851560	CNU/8/560 TAGS from 51 to 60	500
NU0851570V	NU0851570	CNU/8/570 TAGS from 61 to 70	500
NU0851580V	NU0851580	CNU/8/580 TAGS from 71 to 80	500
NU0851590V	NU0851590	CNU/8/590 TAGS from 81 to 90	500
NU08515V	NU08515	CNU/8/555 100 TAGS 5	500
NU0851600V	NU0851600	CNU/8/600 TAGS from 91 to 100	500
NU0851601V	NU0851601	CNU/8/601 TAGS from 601 to 650	500
NU0851651V	NU0851651	CNU/8/651 TAGS from 651 to 700	500
NU08516V	NU08516	CNU/8/666 100 TAGS 6	500
NU0851701V	NU0851701	CNU/8/701 TAGS from 701 to 750	500
NU0851751V	NU0851751	CNU/8/751 TAGS from 751 to 800	500
NU08517V	NU08517	CNU/8/777 100 TAGS 7	500
NU0851801V	NU0851801	CNU/8/801 TAGS from 801 to 850	500
NU0851851V	NU0851851	CNU/8/851 TAGS from 851 to 900	500
NU08518V	NU08518	CNU/8/888 100 TAGS 8	500
NU0851901V	NU0851901	CNU/8/901 TAGS from 901 to 950	500
NU0851951V	NU0851951	CNU/8/951 TAGS from 951 to 1,000	500
NU08519V	NU08519	CNU/8/999 100 TAGS 9	500
NU0851AV	NU0851A	CNU/8/031 100 TAGS A	500
NU0851BV	NU0851B	CNU/8/032 100 TAGS B	500
NU0851CV	NU0851C	CNU/8/033 100 TAGS C	500
NU0851DV	NU0851D	CNU/8/034 100 TAGS D	500
NU0851EV	NU0851E	CNU/8/035 100 TAGS E	500
NU0851FV	NU0851F	CNU/8/036 100 TAGS F	500
NU0851GV	NU0851G	CNU/8/037 100 TAGS G	500
NU0851HV	NU0851H	CNU/8/038 100 TAGS H	500
NU0851IV	NU0851I	CNU/8/043 100 TAGS I	500
NU0851JV	NU0851J	CNU/8/049 100 TAGS J	500
NU0851KV	NU0851KV	CNU/8/050 TAGS K	500
NU0851LV	NU0851L	CNU/8/044 100 TAGS L	500
NU0851MV	NU0851M	CNU/8/045 100 TAGS M	500
NU0851NV	NU0851N	CNU/8/016 100 TAGS N	500
NU0851OV	NU0851O	CNU/8/046 100 TAGS O	500
NU0851PV	NU0851P	CNU/8/047 100 TAGS P	500
NU0851QV	NU0851Q	CNU/8/048 100 TAGS Q	500
NU0851RV	NU0851R	CNU/8/013 100 TAGS R	500
NU0851SV	NU0851S	CNU/8/014 100 TAGS S	500
NU0851TV	NU0851T	CNU/8/015 100 TAGS T	500
NU0851UV	NU0851UV	CNU/8/017 100 TAGS U	500
NU0851VV	NU0851V	CNU/8/018 100 TAGS V	500
NU0851WV	NU0851W	CNU/8/019 100 TAGS W	500
NU0851XV	NU0851X	CNU/8/020 100 TAGS X	500
NU0851YV	NU0851Y	CNU/8/021 100 TAGS Y	500
NU0851ZV	NU0851Z	CNU/8/022 100 TAGS Z	500



Writing type

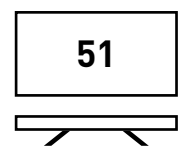

HORIZONTAL

Writing type

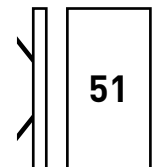

VERTICAL



Mounting on Cabur terminal blocks.

Personalised printing service

Special numbering for terminal block marking

Cabur can supply, on request, special marking tags with numbers, letters, symbols and customised logos in packs of 500 tags, printed using the CaburJet system.

Request special marking by specifying the following on the order:

- A - Article cat. no., chosen from those indicated in the table (e.g. NU0851SP)
- B - Quantity of tags ordered (min. 500 pcs. / 1 pk.)
- C - Writing type (horizontal or vertical)
- D - Content (text, numbers, symbols) to be printed on the tags (e.g. A1B)

To optimise the service, as an alternative or in addition to that required at points c) and d), we recommend sending Cabur a Marking Pro file created with the specific requirements of the order.

For example, by ordering:

Cat. No.: NU0851SP
 Quantity: 1000
 Writing type: horizontal
 Content: ABC

An order will be placed for 2 packs of 500 tags each of CNU/8/51, customised as requested.

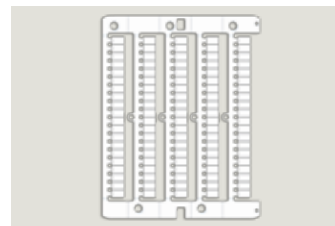
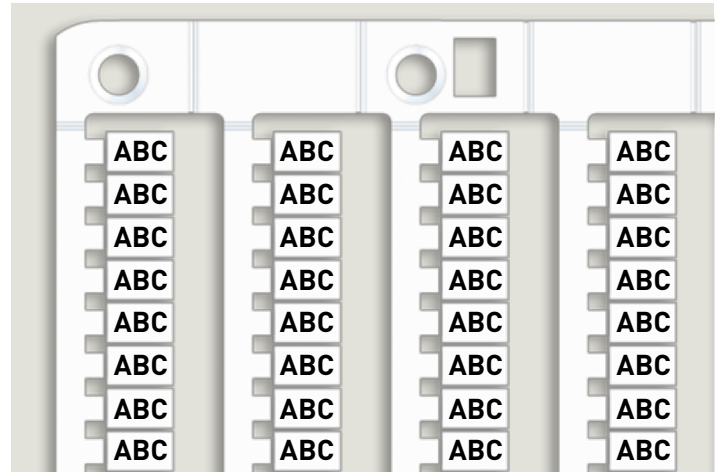

Mounting on Cabur terminal blocks

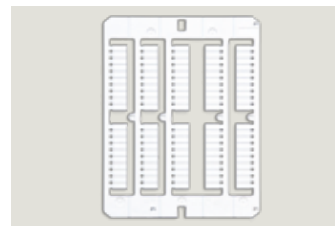

Tag SH004

Writing type

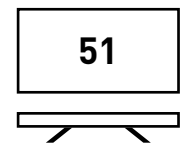

HORIZONTAL

Writing type

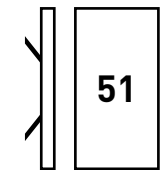

VERTICAL

SPECIAL NUMBERING		
CAT. NO.	TYPE	DESCRIPTION
NU0800SP	NU0800SP	CNU/8/00 – special marking
NU0851SP	NU0851SP	CNU/8/51 – special marking
NU0861SP	NU0861SP	CNU/8/61 – special marking
NU1051SP	NU1051SP	CNU/10/51 – special marking
NU1061SP	NU1061SP	CNU/10/61 – special marking
SH004SP	SH004SP	SHZ.1 – special marking
SH004	SHZ/1/100	Blank tag spring-clamp terminal blocks sect 1.5 mm
SN008	SNZ/4/00	Blank strips
SN004SP	SNZ/4/SP	SN004SP - special numbering
NUWDU50SP	NUWDU50SP	NUWDU50 - special numbering
NUWDK50SP	NUWDK50SP	NUWDK50 - special numbering
NUPUTUK50SP	NUPUTUK50SP	NUPUTUK50 - special numbering
NUL1061	NUL1061	NUL1061 - special numbering

N.B. please contact our sales office for information about availability



Specific accessories

Short circuit plates



SCB/6/PO/2 Cat. No. **SB203**

Short circuit plate for two adjacent SCB.6 terminal blocks



SCB/6/PO/4 Cat. No. **SB204**

Short circuit plate for four adjacent SCB.6 terminal blocks



HSCB/6/PO/2 Cat. No. **HB203**

Short circuit plate for two adjacent HSCB.6 terminal blocks



HSCB/6/PO/4 Cat. No. **HB204**

Short circuit plate for four adjacent HSCB.6 terminal blocks



SCB/4/PO/2 Cat. No. **SB303**

Short circuit plate for two adjacent SCB.4 terminal blocks



SCB/4/PO/4 Cat. No. **SB304**

Short circuit plate for four adjacent SCB.4 terminal blocks



SCX/PO/2 Cat. No. **SC103**

Short circuit plate for two adjacent SCX.10 terminal blocks



SCX/PO/4 Cat. No. **SC104**

Short circuit plate for four adjacent SCX.10 terminal blocks

These allow simultaneous connection to earth of the current reducers, already connected to the SCB.4, SCB.6 and SCX.10. terminal blocks.
They consist of special platelets and sleeves that guarantee the correct sequence of the operation.
The platelets, in the open position, block the movements of the cursors, preventing disconnection of the current circuits.

Short circuit screws and sleeves



SCB/6/CPM Cat. No. **SB205**

Sleeve to be used with SCB/6/PO link



HSCB.6/CPM Cat. No. **HB205**

Sleeve to be used with HSCB/6/PO link



SCB/4/CPM Cat. No. **SB305**

Sleeve to be used with SCB/4/PO link



SCX/CPM Cat. No. **SC105**

Sleeve to be used with SCX/PO link (*)

(*) they are supplied mounted as in A. It is necessary to remove, as in pos. B, the one to introduce into the platelet slot, put it back and screw it onto the body of the terminal block.

Internal/external parallel device



FVS/VCI Cat. No. **FV107**

Screw and sleeve to perform the internal link between the front and back conducting bodies of FVS.4 terminal block.



FVS/VCE Cat. No. **FV108**

Screw and sleeve to perform the internal and external link between the front and back conducting bodies of FVS.4 terminal blocks.

Conducting elements



CO/5 Cat. No. **VL103**

Ø 5 x 20 mm - in brass for terminal block types:
SFO.4 - SFR.4 - SFR.6/M - FLD.10/F5 - HMF.4 - VLM.10



SFC/CO Cat. No. **FC102**

Ø 6,3 x 32 mm - in brass for terminal block types:
FPC.10 - SFC.10 - SFR.6 - with possible derivation by means of plug SDD/2

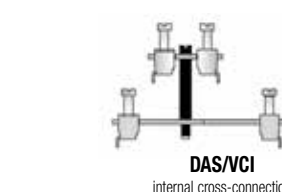

DAS/VCI Cat. No. **DS107**

Screw and sleeve for internal connection between the front conductor body and the rear one of the DAS.4



DAS/VCE Cat. No. **DS108**

Screw and sleeve for internal connection between the front and rear conductor bodies and external connection between the conductor bodies of contiguous terminal blocks, for the DAS.4

The terminal blocks for Ø 5 x 20 mm or 6 x 32 mm fuses can be used as terminal blocks for simple switching inserting specific **conducting elements**.

Small screening bar



CBD/SH Cat. No. **CB009**

For the connection of the cable shielding - to be used on terminal blocks type CBD.2, 4, 6, 10.

Index for marking

A

TYPE	CAT. NO.	QTY. per pk.	PAGE
ACB.120/BB	AC400	12	21
ACB.185/BB	AC700	12	21
ACB.70/BB	AC100	12	21
ACI121017	Z121017	25	121
ACI121019	Z121019	25	121
ACI121026	Z121026	100	126
ACI121116	Z121116	10	123
ACI121118	Z121118	50	126
ACI121119	Z121119	100	126
ACI121121	Z121121	100	126
ACI121123	Z121123	1	126
ACI121211	Z121211	25	126
ACI121212	Z121212	25	126
ACI121213	Z121213	20	125
ACI121214	Z121214	20	125
ACI121215	Z121215	20	125
ACI121216	Z121216	10	125
ACI121217	Z121217	10	125
ACI121218	Z121218	10	125
ACI121219	Z121219	10	125
ACI121221	Z121221	50	126
ACI121228	Z121228	20	123
ACI121301	Z121301	10	123
ACI121307	Z121307	50	126
ACI121311	Z121311	20	123
ACI121314	Z121314	20	123
ACI121316	Z121316	20	124
ACI121317	Z121317	10	124
ACI121318	Z121318	10	124
ACI121319	Z121319	10	124
ACI121410	Z121410	10	124
ACI121415	Z121415	20	123
ACI121421	Z121421	100	126
AFO.2/1+1	AF500	100	53
AFO.2/2+2	AF400	100	53
AFO.2/2+2/TP	AF410	100	53
AFO/PT	AF201	50	53
AFO/PT	AF201GR	50	118

B

BPL.4	BP100	60	63
BPL.4/PS	BP300	60	64
BPL.4/PS/A	BP310	60	64
BPL/R	BP200	100	63
BT/2	BT006	25	119
BT/3	BT003	25	119
BTO	BT007	25	119
BTU	BT005	25	119

C

CAM	MA110	100	59
CAM/B	MA111	100	59
CAM/C	MA112	80	59
CAMUT.12/02	CAMUT02	10	111
CAMUT.12/04	CAMUT04	10	111
CAMUT.12/06	CAMUT06	10	111
CAMUT.12/10	CAMUT10	10	111

TYPE	CAT. NO.	QTY. per pk.	PAGE
CAMUT.12/16	CAMUT16	10	111
CAMUT.12/25	CAMUT25	10	111
CB/PT(Ex)i	CB402	25	34
CB/PT/GR	CB401GR	25	34
CB10/PT	CB431	25	14
CB10/PT(EX)I	CBX44	25	14
CB16/PT	CB511	25	14
CB16/PT(EX)I	CBX53	25	14
CB2/PT	CB111	50	55
CB2/PT(EX)I	CBX13	50	55
CB2/PT/GR	CB111GR	50	55
CB35/PT	CB611	25	14
CB35/PT(EX)I	CBX63	25	14
CB4/6/PT	CB241	25	13
CB4/6/PT(EX)I	CBX25	25	13
CB50/PT	CB711	10	15
CB50/PT(EX)I	CBX73	10	15
CB70/PT	CB811	10	15
CB70/PT(EX)I	CBX83	10	15
CBC.10 (EX)I	CBI10	100	4
CBC.10/GR	CBC10GR	100	4
CBC.16 (EX)I	CBI16	50	4
CBC.16/GR	CBC16GR	50	4
CBC.16/PT(EX)I	CBI161	25	4
CBC.2 (EX)I	CBI02	120	3
CBC.2-10/PT(EX)I	CBI061	50	4
CBC.2/GR	CBC02GR	120	3
CBC.35 (EX)I	CBI35	50	4
CBC.35/GR	CBC35GR	50	4
CBC.35/PT(EX)I	CBI351	25	4
CBC.4 (EX)I	CBI04	100	3
CBC.4/GR	CBC04GR	100	3
CBC.6 (EX)I	CBI06	100	3
CBC.6/GR	CBC06GR	100	3
CBD.10	CB440	100	14
CBD.10 (EX)I	CBX45	100	14
CBD.16	CB510	50	14
CBD.16 (EX)I	CBX52	50	14
CBD.2	CB110	120	13
CBD.2 (EX)I	CBX12	120	13
CBD.35	CB610	75	14
CBD.35 (EX)I	CBX62	75	14
CBD.4	CB240	100	13
CBD.4 (EX)I	CBX24	100	13
CBD.50	CB710	50	15
CBD.50 (EX)I	CBX72	50	15
CBD.6	CB340	100	13
CBD.6 (EX)I	CBX34	100	13
CBD.70	CB810	40	15
CBD.70 (EX)I	CBX82	40	15
CBD/SH	CB009	10	151
CBE.2	CE110	70	24
CBR.2	CR110	75	5

TYPE	CAT. NO.	QTY. per pk.	PAGE
CBF.4/C48/GR	CBF448GR	50	40
CBF.4/C230/GR	CBF423GR	50	40
CBF.4 (Ex)i	CBF04I	50	34
CBF.04/GR	CBF04GR	50	34
CBR.2/GR	CR110GR	75	5
CBR/PT	CR111	25	5
CBS.2 (Ex)i	CBS02I	100	41
CBS.2/GR	CBS02GR	100	41
CBS.2	CBS02	100	41
CBS.4 (Ex)i	CBS04I	80	41
CBS.4/GR	CBS04GR	80	41
CBS.4	CBS04	80	41
CB/PT	CB401	25	41
CCH/2.5-4	CCH02	1	112
CCH/6	CCH06	1	112
CCV/2.5	CCV03	1	112
CCV/4	CCV04	1	112
CCV/5	CCV05	1	112
CF.08/2+2	CF400	40	66
CF.12/2+2	CF200	25	66
CF.12/CPT	CF900	40	65
CF/PTM	CF301	25	65
CHP.2/GR	HVP900GR	20	88
CHP.2D/GR	HVP910GR	20	88
CHTE.2	HVT900	20	89
CHTE.2D	HVT910	20	89
CIL/115-230	SF510	10	138
CIL/12-48	SF518	10	138
CIL/CBF/110-230	CB523	10	34
CIL/CBF/12-48	CB518	10	34
CNT.16	CNT16	25	67
CNT.35	CNT35	15	67
CNT.6	CNT06	40	67
CNU/10/51	NU1051	1500	143
CNU/10/51	NU1051SP	500	150
CNU/10/61	NU1061	1200	143
CNU/10/61	NU1061SP	400	150
CNU/8/010	NU0851010	500	148
CNU/8/013	NU0851R	500	148
CNU/8/014	NU0851S	500	148
CNU/8/015	NU0851T	500	148
CNU/8/016	NU0851N	500	148
CNU/8/017	NU0851U	500	148
CNU/8/018	NU0851V	500	148
CNU/8/019	NU0851W	500	148
CNU/8/020	NU0851X	500	148
CNU/8/021	NU0851Y	500	148
CNU/8/022	NU0851Z	500	148
CNU/8/024	NU085112	500	148
CNU/8/025	NU085110	500	148
CNU/8/027	NU085114	500	148
CNU/8/030	NU0851	1500	148
CNU/8/031	NU0851A	500	148

Index for marking

TYPE	CAT. NO.	QTY. per pk.	PAGE	TYPE	CAT. NO.	QTY. per pk.	PAGE	TYPE	CAT. NO.	QTY. per pk.	PAGE
CNU/8/032	NU0851B	500	148	CNU/8/61	NU0861	1200	143	CPM/21	CPM21	25	134
CNU/8/033	NU0851C	500	148	CNU/8/61	NU0861SP	400	150	CPM/25	CPM25	25	134
CNU/8/034	NU0851D	500	148	CNU/8/651	NU0851651	500	148	CPM/25	CPM25	25	134
CNU/8/035	NU0851E	500	148	CNU/8/666	NU08516	500	148	CPM/44	CPM44	25	134
CNU/8/036	NU0851F	500	148	CNU/8/701	NU0851701	500	148	CPM/53	CPM53	25	134
CNU/8/037	NU0851G	500	148	CNU/8/751	NU0851751	500	148	CPM/57	CPM57	25	134
CNU/8/038	NU0851H	500	148	CNU/8/777	NU08517	500	148	CPM/70	CPM70	25	134
CNU/8/043	NU0851I	500	148	CNU/8/801	NU0851801	500	148	CPM/83	CPM83	25	134
CNU/8/044	NU0851L	500	148	CNU/8/851	NU0851851	500	148	CPM/99	CPM99	25	134
CNU/8/045	NU0851M	500	148	CNU/8/888	NU08518	500	148	CPX/01	CPX01	25	134
CNU/8/046	NU0851O	500	148	CNU/8/901	NU0851901	500	148	CPX/03	CPX03	25	134
CNU/8/047	NU0851P	500	148	CNU/8/951	NU0851951	500	148	CPX/06	CPX06	10	134
CNU/8/048	NU0851Q	500	148	CNU/8/999	NU08519	500	148	CPX/07	CPX07	10	134
CNU/8/049	NU0851J	500	148	CNU/8/L1	NU08510L1	500	148	CPX/08	CPX08	10	134
CNU/8/050	NU0851K	500	148	CNU/8/L2	NU08510L2	500	148	CPX/12	CPX12	25	134
CNU/8/051	NU0851051	500	148	CNU/8/L3	NU08510L3	500	148	CPX/21	CPX21	25	134
CNU/8/101	NU0851101	500	148	CNU/8/NI	NU08510NI	500	148	CPX/44	CPX44	25	134
CNU/8/11	NU0851011	500	148	CNU/8/PE	NU08510PE	500	148	CPX/83	CPX83	25	134
CNU/8/111	NU08511	500	148	CNU/8/R1	NU08510R1	500	148	CVF.4	CV100	100	54
CNU/8/12	NU0851012	500	148	CNU/8/S1	NU08510S1	500	148	CVF.4 (EX)I	CV200	100	54
CNU/8/13	NU0851013	500	148	CNU/8/S2	NU08510S2	500	148	CVF/PT	CV101	25	54
CNU/8/14	NU0851014	500	148	CNU/8/S3	NU08510S3	500	148	CVF/PT(EX)I	CV201	25	54
CNU/8/15	NU0851015	500	148	CNU/8/U1	NU08510U1	500	148	DAS.4	DS100	120	29
CNU/8/151	NU0851151	500	148	CNU/8/U2	NU08510U2	500	148	DAS.4 (EX)I	DS200	120	29
CNU/8/16	NU0851016	500	148	CNU/8/V1	NU08510V1	500	148	DAS.4/A	DS111	20	52
CNU/8/17	NU0851017	500	148	CNU/8/V2	NU08510V2	500	148	DAS.4/A/GR	DS111GR	20	52
CNU/8/18	NU0851018	500	148	CNU/8/W1	NU08510W1	500	148	DAS.4/B	DS112	20	52
CNU/8/19	NU0851019	500	148	CNU/8/W2	NU08510W2	500	148	DAS.4/B/GR	DS112GR	20	52
CNU/8/20	NU0851020	500	148	CO/5	VL103	50	151	DAS.4/C	DS113	20	52
CNU/8/201	NU0851201	500	148	CONTC/1,5	CONTC01	10	107	DAS.4/C/GR	DS113GR	20	52
CNU/8/222	NU08512	500	148	CONTC/10	CONTC10	5	107	DAS.4/CI	DS117	120	29
CNU/8/251	NU0851251	500	148	CONTC/16	CONTC16	5	107	DAS.4/CI (EX)I	DS217	120	29
CNU/8/2A	NU085102A	500	148	CONTC/2,5	CONTC02	10	107	DAS.4/CI/GR	DS117GR	120	29
CNU/8/301	NU0851301	500	148	CONTC/2/16	CONT216	20	108	DAS.4/D	DS114	20	52
CNU/8/333	NU08513	500	148	CONTC/2/25	CONT225	10	108	DAS.4/D/GR	DS114GR	20	52
CNU/8/351	NU0851351	500	148	CONTC/2/35	CONT235	5	108	DAS.4/D12	DSD012	20	50
CNU/8/401	NU0851401	500	148	CONTC/2/6	CONT206	20	108	DAS.4/D12/GR	DSD012GR	20	50
CNU/8/444	NU08514	500	148	CONTC/25	CONTC25	5	107	DAS.4/D24	DSD024	20	50
CNU/8/451	NU0851451	500	148	CONTC/3/16	CONT316	5	109	DAS.4/D24/GR	DSD024GR	20	50
CNU/8/501	NU0851501	500	148	CONTC/3/6	CONT306	10	109	DAS.4/D5	DSD005	20	50
CNU/8/51	NU0851	1500	143	CONTC/35	CONTC35	5	107	DAS.4/D5/GR	DSD005GR	20	50
CNU/8/51	NU0851SP	500	150	CONTC/4	CONTC04	10	107	DAS.4/D60	DSD060	20	50
CNU/8/510	NU0851510	500	148	CONTC/5/6	CONT506	10	110	DAS.4/D60/GR	DSD060GR	20	50
CNU/8/520	NU0851520	500	148	CONTC/6	CONTC06	10	107	DAS.4/DD	DS120	20	52
CNU/8/530	NU0851530	500	148	CPF/5	CPF05	20	38	DAS.4/DD/GR	DS120GR	20	52
CNU/8/540	NU0851540	500	148	CPF/5	CPF05	20	85	DAS.4/E	DS115	20	52
CNU/8/550	NU0851550	500	148	CPM/01	CPM01	25	134	DAS.4/E/GR	DS115GR	20	52
CNU/8/551	NU0851551	500	148	CPM/03	CPM03	25	134	DAS.4/GR	DS100GR	120	29
CNU/8/555	NU08515	500	148	CPM/06	CPM06	10	134	DAS.4/I	DS119	20	52
CNU/8/560	NU0851560	500	148	CPM/07	CPM07	10	134	DAS.4/I/GR	DS119GR	20	52
CNU/8/570	NU0851570	500	148	CPM/08	CPM08	10	134	DAS.4/L	DS130	20	52
CNU/8/580	NU0851580	500	148	CPM/12	CPM12	25	134	DAS.4/L/GR	DS130GR	20	52
CNU/8/590	NU0851590	500	148	CPM/16	CPM16	25	134	DAS.4/SS	DS110	20	30
CNU/8/600	NU0851600	500	148	CPM/17	CPM17	25	134	DAS.4/SS/GR	DS110GR	20	30
CNU/8/601	NU0851601	500	148	CPM/21	CPM21	25	134	DAS.4/T	DS128	20	52

Index for marking

TYPE	CAT. NO.	QTY. per pk.	PAGE	TYPE	CAT. NO.	QTY. per pk.	PAGE	TYPE	CAT. NO.	QTY. per pk.	PAGE
DAS.4/T/GR	DS128GR	20	52	DSS.4	DS400	100	42	GPM.150/BC	GP500	6	19
DAS.4/U	DS129	20	52	DSS.4/GR	DS400GR	100	30	GPM.150/BC/FIX	GP510	4	19
DAS.4/U/GR	DS129GR	20	52	DSS.4/GR	DS400GR	100	42	GPM.150/C/BB	GP425		18
DAS.4/V120	DSV120	20	51	DSS/PT	DS301	25	37	GPM.150/C/BB/FIX	GP435		18
DAS.4/V120/GR	DSV120GR	20	51	F5/1 A	FN006ST	100	138	GPM.150/CC	GP600	6	20
DAS.4/V230	DSV230	20	51	F5/1.6 A	FN007ST	100	138	GPM.150/CC/FIX	GP610	6	20
DAS.4/V230/GR	DSV230GR	20	51	F5/10 A	FN015ST	100	138	GPM.150/O/BB	GP420		18
DAS.4/V24	DSV024	20	51	F5/100 MA	FN001ST	100	138	GPM.150/O/BB/FIX	GP430		18
DAS.4/V24/GR	DSV024GR	20	51	F5/12 A	FN016ST	100	138	GPM.240/BB	GP700	4	17
DAS.4/V48	DSV048	20	51	F5/2 A	FN008ST	100	138	GPM.240/BB/FIX	GP710	4	17
DAS.4/V48/GR	DSV048GR	20	51	F5/2.5 A	FN009ST	100	138	GPM.240/BB/FIX/GR	GP710GR	4	17
DAS/PT	DS101	25	29	F5/200 MA	FN002ST	100	138	GPM.240/BB/GR	GP700GR	4	17
DAS/PT(EX)I	DS201	25	29	F5/3.15 A	FN010ST	100	138	GPM.240/BC	GP800	4	19
DAS/VCE	DS108	25	151	F5/315 MA	FN003ST	100	138	GPM.240/BC/FIX	GP810	4	19
DAS/VCI	DS107	25	151	F5/4 A	FN011ST	100	138	GPM.240/C/BB	GP725		18
DBC.2	DB100	120	27	F5/5 A	FN012ST	100	138	GPM.240/C/BB/FIX	GP735		18
DBC.2 (EX)I	DB200	120	27	F5/500 MA	FN004ST	100	138	GPM.240/CC	GP900	4	20
DBC.2/CI	DB117	120	27	F5/6.3 A	FN013ST	100	138	GPM.240/CC/FIX	GP910	4	20
DBC.2/CI/GR	DB117GR	120	27	F5/630 MA	FN005ST	100	138	GPM.240/O/BB	GP720		18
DBC.2/GR	DB100GR	120	27	F5/8 A	FN014ST	100	138	GPM.240/O/BB/FIX	GP730		18
DBC.4(Ex)i	DB500	100	28	FDP:2	FD100	70	54	GPM.95/BB	GP100	10	17
DBC.4/CI(Ex)i	DB517	100	28	FDP:2/GR	FD100GR	70	54	GPM.95/BB/FIX	GP110	10	17
DBC.4/CI/GR	DB417GR	100	28	FDP/PT	FD101	25	54	GPM.95/BB/FIX/GR	GP110GR	10	17
DBC.4GR	DB400GR	100	28	FFS.4	FF100	120	31	GPM.95/BB/GR	GP100GR	10	17
DBC.4/PT/GR	DB401GR	25	28	FFS.4/GR	FF100GR	120	31	GPM.95/BC	GP200	10	19
DBC.4/PT (Ex)i	DB402	25	28	FFS/PT	FF101	25	31	GPM.95/BC/FIX	GP210	10	19
DBC/PT	DB101	25	27	FPC.10	FP100	70	39	GPM.95/C/BB	GP125		18
DBC/PT(EX)I	DB201	25	27	FPC.10	FP100	70	44	GPM.95/C/BB/FIX	GP135		18
DF/VPC	DU02S	25	56	FPL.10/C	FP300	70	39	GPM.95/CC	GP300	10	20
DFH/1/RED	DH01R	25	139	FPL.10/C230	FP923	70	40	GPM.95/CC/FIX	GP310	10	20
DFH/2/RED	DH02R	25	139	FPL.10/C48	FP948	70	40	GPM.95/O/BB	GP120		18
DFH/3/RED	DH03R	25	139	FPL.10/L	FP200	70	39	GPM.95/O/BB/FIX	GP130		18
DFH/4/RED	DH04R	25	139	FVS.4	FV100	120	31	HCD.1 (EX)I	HC210	40	87
DFM/300	DF300	50	140	FVS.4/GR	FV100GR	120	31	HCD.1/GR	HC200GR	40	87
DFM/400	DF400	50	140	FVS/PT	FV101	25	31	HCD.1/PT/GR	HC201GR	25	87
DFM/500	DF500	50	140	FVS/VCE	FV108	25	151	HDE.2/GR	HL500GR	50	83
DFM/600	DF600	50	140	FVS/VCI	FV107	25	151	HFR.4/GR	HF210GR	70	86
DFM/700	DF700	50	140	GPA.150	GA200	8	7	HFR.4/M/GR	HF310GR	100	86
DFM/800	DF800	50	140	GPA.150/FIX	GF200	8	7	HFR.4/PT/GR	HF211GR	25	86
DFM/900	DF900	50	140	GPA.150/GR	GA200GR	8	7	HLD.2/CI/GR	HL210GR	50	83
DFP/2/RED	DFP2R	50	139	GPA.240	GA300	4	7	HLD.2/GR	HL200GR	50	83
DFS.4/PT/GR	DS401GR	25	36	GPA.240/FIX	GF300	4	7	HLD.2/PT/GR	HL201GR	25	83
DFU/1/RED	DU01R	50	139	GPA.240/GR	GA300GR	4	7	HMD.1 (EX)I	HD300	50	80
DFU/2/RED	DU02R	50	139	GPA.70	GA400	25	6	HMD.1/CI/GR	HD120GR	50	80
DFU/3/RED	DU03R	50	139	GPA.70/FIX	GF400	25	6	HMD.1/GR	HD200GR	50	80
DFU/4/RED	DU04R	50	139	GPA.70/FIX/GR	GF400GR	25	6	HMD.1/PT/GR	HD201GR	25	80
DFU/5/RED	DU05R	25	139	GPA.70/GR	GA400GR	25	6	HMD.1/X/GR	HD130GR	50	81
DFU/6/RED	DU06R	25	139	GPA.95	GA100	10	6	HMD.2/GR	HD100GR	60	80
DFU/7/RED	DU07R	25	139	GPA.95/FIX	GF100	10	6	HMD.2N (EX)I	HD410	40	80
DSF.4/GR	DA200GR	80	36	GPA.95/FIX/GR	GF100GR	10	6	HMD.2N/3DC/GR	HD430GR	40	81
DSFA.4	DA100	100	37	GPA.95/GR	GA100GR	10	6	HMD.2N/CI/GR	HD450GR	40	80
DSFA.4/GR	DA100GR	100	37	GPM.150/BB	GP400	6	17	HMD.2N/DD/GR	HD420GR	40	81
DSFA.4/L12	DA112	100	37	GPM.150/BB/FIX	GP410	6	17	HMD.2N/GR	HD400GR	40	80
DSFA.4/L24	DA124	100	37	GPM.150/BB/FIX/GR	GP410GR	6	17	HMD.2N/X/GR	HD440GR	40	81
DSS.4	DS400	100	30	GPM.150/BB/GR	GP400GR	6	17	HMD.2N/X1/GR	HD441GR	40	82

Index for marking

TYPE	CAT. NO.	QTY. per pk.	PAGE	TYPE	CAT. NO.	QTY. per pk.	PAGE	TYPE	CAT. NO.	QTY. per pk.	PAGE
HMD/PT/GR	HD101GR	25	80	HMT.6/PT/GR	HM321GR	25	74	MCM.3/R	MC203R	1	96
HMFA.2/GR	HF300GR	80	85	HP.2 (EX)I	HI130	100	90	MCM.3/VE/B	MC233B	1	97
HMM.1 (EX)I	HI400	100	70	HP.2/GR	HP150GR	100	90	MCM.3/VE/G	MC233G	1	97
HMM.1/1+2 (EX)I	HI410	80	70	HPC.2 (EX)I	HI131	100	91	MCM.3/VE/R	MC233R	1	97
HMM.1/1+2/GR	HM410GR	80	70	HPC.2/GR	HP160GR	100	91	MCT.1/SA/B	MC401B	1	98
HMM.1/2+2 (EX)I	HI420	60	70	HPP.2 (EX)I	HI132	100	90	MCT.1/SA/G	MC401G	1	98
HMM.1/2+2/GR	HM420GR	60	70	HPP.2/GR	HP170GR	100	90	MCT.1/SA/R	MC401R	1	98
HMM.1/GR	HM400GR	100	70	HPV/PT/GR	HV111GR	25	90	MCT.2/SA/B	MC402B	1	98
HMM.10 (EX)I	HI330	30	74	HSCB.4/GR	HB100GR	90	84	MCT.2/SA/G	MC402G	1	98
HMM.10/GR	HM330GR	30	74	HSCB.4/PT/GR	HB101GR	25	90	MCT.2/SA/R	MC402R	1	98
HMM.16 (EX)I	HI340	30	74	HSCB.4/CPM	HB405	40	84	MCT.3/SA/B	MC403B	1	99
HMM.16/GR	HM340GR	30	74	HSCB.4/PO/4	HB404	20	84	MCT.3/SA/G	MC403G	1	99
HMM.2 (EX)I	HI500	80	71	HSCB.4/PO/2	HB403	40	84	MCT.3/SA/R	MC403R	1	99
HMM.2/1+2 (EX)I	HI510	80	71	HSCB.6/CPM	HB205	40	151	MPFA.4	MF100	100	37
HMM.2/1+2/GR	HM510GR	80	71	HSCB.6/GR	HB200GR	60	84	MPFA.4/GR	MF100GR	100	37
HMM.2/1+2/S/GR	HMS20GR	80	72	HSCB.6/PT/GR	HB201GR	25	84	MPFA.4/L12	MF112	100	37
HMM.2/2+2 (EX)I	HI520	60	71	HSCB.6/PO/2	HB203	40	151	MPFA.4/L24	MF124	100	37
HMM.2/2+2/A/GR	HM170GR	60	72	HSCB.6/PO/4	HB204	20	151	MPS.4	MP950	100	42
HMM.2/2+2/GR	HM520GR	60	71	HTE.1	HT400	80	76	MPS.4/GR	MP950GR	100	42
HMM.2/2+2/S/GR	HMS10GR	60	72	HTE.1/1+2	HT410	80	76	MPS.4/PT	MP901	25	37-42
HMM.2/GR	HM500GR	80	71	HTE.1/2+2	HT420	60	76	MPS.4/PT(EX)I	MP902	25	42
HMM.4 (EX)I	HI250	60	73	HTE.10	HT330	30	79	MPS.4/SW (EX)I	MP960	100	42
HMM.4/1+2 (EX)I	HI210	40	73	HTE.16	HT340	30	79	MS/8X10/N	MZ300N	1	100
HMM.4/1+2/GR	HM210GR	40	73	HTE.2	HT500	80	77	MS/8X10/T	MZ300T	1	100
HMM.4/2+2 (EX)I	HI220	20	73	HTE.2/1+2	HT510	80	77	MSM	FC103	10	142
HMM.4/2+2/GR	HM220GR	40	73	HTE.2/2+2	HT520	60	77	NCS	NC100	100	93
HMM.4/GR	HM250GR	60	73	HTE.4	HT250	60	78	NCS/PT	NC101	25	93
HMM.6 (EX)I	HI320	30	74	HTE.4/1+2	HT260	40	78	NCV	NC200	100	93
HMM.6/GR	HM320GR	30	74	HTE.4/2+2	HT270	20	78	PADCABUR	PADCABUR	1	147
HMR.16/D/GR	HM360GR	30	75	HTE.6	HT320	30	79	PADGRAPH	PADGRAPH	1	147
HMR.16/GR	HM350GR	15	75	HTTE.2	HLT500	50	83	PADMUTHO	PADMUTHO	1	147
HMS.2/GR	HS200GR	80	84	HVPC.2/GR	HVP300GR	120	88	PDF.2	PF100	75	54
HMT.1/1+2/PT	HM411GR	25	70	HVTE.2	HVT500	80	89	PDF/PT	PF101	25	54
HMT.1/1+2/PT(EX)I	HI411	25	70	INKBOTT1	INKBOTT1	1	147	PEN025CAB	PEN025CAB	1	147
HMT.1/2+2/PT	HM421GR	25	70	INKCART5	INKCART5	1	147	PEN035CAB	PEN035CAB	1	147
HMT.1/2+2/PT(EX)I	HI421	25	70	KITPULIZIA	KITPULIZIA	1	147	PEN035GRA	PEN035GRA	1	147
HMT.1/PT	HM401GR	25	70	KSLOTTER	KSLOTTER	1	147	PH/2.5-4	PH100	25	132
HMT.1/PT(EX)I	HI401	25	70	MAC.6	MA100	80	58	PH/2.5-4	PH100	25	132
HMT.1/PT/GR	HM401GR	25	70	MAC.6/FS	MA410	80	58	PHD/2	PHD02	25	132
HMT.2/1+2/PT	HM511GR	25	71	MAC.6/N	MA200	80	58	PM/10/10	PM100	10	127
HMT.2/1+2/PT(EX)I	HI511	25	71	MAC/COS	MA030	25	59	PM/10/2	PM102	25	127
HMT.2/1+2/PT/GR	HM511GR	25	71	MAC/CP8	MA040	20	59	PM/10/3	PM103	25	127
HMT.2/1+2/PT/GR	HM521GR	25	71	MAC/PLZ	MA010	50	59	PM/10/5	PM105	25	127
HMT.2/2+2/PT	HM521GR	25	71	MBL.120/10	MB300	10	23	PM/11/10	PM110	10	127
HMT.2/2+2/PT(EX)I	HI521	25	71	MBL.150/12	MB400	10	23	PM/11/2	PM112	25	127
HMT.2/2+2/PT/GR	HM511GR	25	71	MBL.50/6	MB100	10	22	PM/11/3	PM113	25	127
HMT.2/2+2/PT/GR	HM521GR	25	71	MBL.95/8	MB200	10	22	PM/11/5	PM115	25	127
HMT.2/PT	HM501GR	25	71	MCM.1/B	MC201B	1	95	PM/12/10	PM120	10	127
HMT.2/PT(EX)I	HI501	25	71	MCM.1/G	MC201G	1	95	PM/12/2	PM122	25	127
HMT.2/PT/GR	HM501GR	25	71	MCM.1/R	MC201R	1	95	PM/12/3	PM123	25	127
HMT.4/PT	HM251GR	25	73	MCM.2/B	MC202B	1	96	PM/12/5	PM125	25	127
HMT.4/PT(EX)I	HI251	25	73	MCM.2/G	MC202G	1	96	PM/20/10	PM210	10	127
HMT.4/PT/GR	HM251GR	25	73	MCM.2/R	MC202R	1	96	PM/20/10	PM210	10	127
HMT.6/PT	HM321GR	25	74	MCM.3/B	MC203B	1	96	PM/20/2	PM202	25	127
HMT.6/PT(EX)I	HI321	25	74	MCM.3/G	MC203G	1	96	PM/20/2	PM202	25	127

Index for marking

TYPE	CAT. NO.	QTY. per pk.	PAGE	TYPE	CAT. NO.	QTY. per pk.	PAGE	TYPE	CAT. NO.	QTY. per pk.	PAGE
PM/20/3	PM203	25	127	POF/12	POF12	25	133	PRT/M	PRT02	15	140
PM/20/3	PM203	25	127	POF/13	POF13	25	133	PRT/P	PRT01	20	140
PM/20/5	PM205	25	127	POF/14	POF14	25	133	PSD/A	PD001	50	137
PM/20/5	PM205	25	127	POF/150/2	P0152	10	133	PSD/B	PD002	50	137
PM/25/10	PM250	10	127	POF/150/3	P0153	10	133	PSD/C	PD003	50	137
PM/25/10	PM250	10	127	POF/17	POF17	25	133	PSD/D	PD004	50	137
PM/25/2	PM252	25	127	POF/240/2	P0242	10	133	PSD/J	PD014	50	137
PM/25/2	PM252	25	127	POF/240/3	P0243	10	133	PSD/K	PD011	50	137
PM/25/3	PM253	25	127	POF/44	POF44	25	133	PSD/L	PD009	50	137
PM/25/3	PM253	25	127	POF/53	POF53	25	133	PSD/N	PD013	50	137
PM/25/5	PM255	25	127	POF/54	POF54	25	133	PSD/O	PD017	50	137
PM/25/5	PM255	25	127	POF/55	POF55	25	133	PSD/P	PD015	50	137
PM/30/10	PM310	10	127	POF/56	POF56	25	133	PTC/1/00	PTC0100	8	128
PM/30/3	PM303	25	127	POF/57	POF57	25	133	PTC/1/02	PTC0102	25	128
PM/30/5	PM305	25	127	POF/70	POF70	25	133	PTC/1/03	PTC0103	25	128
PM/40/10	PM400	10	127	POF/95/2	P0952	10	133	PTC/1/05	PTC0105	25	128
PM/40/2	PM402	25	127	POF/95/3	P0953	10	133	PTC/1/10	PTC0110	10	128
PM/40/3	PM403	25	127	POF/99	POF99	25	133	PTC/10/00	PTC1000	8	128
PM/40/5	PM405	25	127	POLM.1215	QPOL1203	10	106	PTC/10/02	PTC1002	25	128
PM/41/10	PM410	10	127	POLM.1215/BLU	QPOL1205	10	106	PTC/10/03	PTC1003	25	128
PM/41/2	PM412	25	127	POLM.1215/TE	QPOL1204	10	106	PTC/10/05	PTC1005	25	128
PM/41/3	PM413	25	127	POMPASP	POMPASP	1	147	PTC/10/10	PTC1010	10	128
PM/41/5	PM415	25	127	POS/08	POS08	15	135	PTC/11/00	PTC1100	8	128
PM/51/10	PM510	10	127	POS/11	POS11	25	135	PTC/11/02	PTC1102	25	128
PM/51/3	PM513	25	127	POS/41	POS41	25	135	PTC/11/03	PTC1103	25	128
PM/51/5	PM515	25	127	POS/42	POS42	25	135	PTC/11/05	PTC1105	25	128
PM/60/10	PM610	10	127	POS/43	POS43	25	135	PTC/11/10	PTC1110	10	128
PM/60/2	PM602	25	127	POS/44	POS44	25	135	PTC/16/00	PTC1600	8	128
PM/60/3	PM603	25	127	POS/53	POS53	15	135	PTC/16/02	PTC1602	25	128
PM/60/5	PM605	25	127	POS/66	POS66	25	135	PTC/16/03	PTC1603	25	128
PM/90/10	PM900	10	127	POS/72	POS72	25	135	PTC/16/05	PTC1605	25	128
PM/90/2	PM902	25	127	POS/93	POS93	25	135	PTC/16/10	PTC1610	10	128
PM/90/3	PM903	25	127	PR/2/AC	PR009	100	122	PTC/2/00	PTC0200	8	128
PM/90/5	PM905	25	127	PR/2/AC/ZB	PR909	100	122	PTC/2/02	PTC0202	25	128
PM/91/10	PM910	10	127	PR/2/AS	PR010	100	122	PTC/2/02	PTC0202	25	132
PM/91/2	PM912	25	127	PR/2/AS/ZB	PR910	100	122	PTC/2/03	PTC0203	25	128
PM/91/3	PM913	25	127	PR/3/AC	PR003	40	121	PTC/2/03	PTC0203	25	132
PM/91/5	PM915	25	127	PR/3/AS	PR005	40	121	PTC/2/05	PTC0205	25	128
PMP/01	PMP01	8	134	PR/3/AC/ZB	PR903	40	121	PTC/2/05	PTC0205	25	132
PMP/02	PMP02	8	134	PR/3/AS/ZB	PR905	40	121	PTC/2/10	PTC0210	10	128
PMP/04	PMP04	8	134	PR/3/PA	PR006	20	121	PTC/20/00	PTC2000	8	128
PMP/05	PMP05	8	134	PR/3/PA/ZB	PR906	20	121	PTC/20/02	PTC2002	25	128
PMP/06	PMP06	8	134	PR/3/PP	PR007	20	121	PTC/20/03	PTC2003	25	128
PMP/07	PMP07	8	134	PR/3/PP/ZB	PR907	20	121	PTC/20/05	PTC2005	25	128
PMP/08	PMP08	8	134	PR/DIN/AC/ZB	PR901	20	122	PTC/20/10	PTC2010	10	128
PMP/13	PMP13	8	134	PR/DIN/AL	PR002	20	122	PTC/3/00	PTC0300	8	128
PMP/16	PMP16	8	134	PR/DIN/AC	PR001	20	122	PTC/3/02	PTC0302	25	128
PMP/17	PMP17	8	134	PR/DIN/AS	PR004	20	122	PTC/3/03	PTC0303	25	128
PMP/25	PMP25	8	134	PR/DIN/AS/ZB	PR904	20	122	PTC/3/05	PTC0305	25	128
PMP/42	PMP42	8	134	PRP/5	PRP05	10	141	PTC/3/10	PTC0310	10	128
PMP/58	PMP58	8	134	PRP/6	PRP06	10	141	PTC/4/00	PTC0400	8	128
POF/06	POF06	15	133	PRP/7	PRP07	10	141	PTC/4/02	PTC0402	25	128
POF/07	POF07	15	133	PRP/7/G	PRP070G	10	142	PTC/4/03	PTC0403	25	128
POF/08	POF08	15	133	PRP/8	PRP08	10	141	PTC/4/05	PTC0405	25	128
POF/11	POF11	25	133	PRT/G	PRT03	10	140	PTC/4/10	PTC0410	10	128

Index for marking

TYPE	CAT. NO.	QTY. per pk.	PAGE	TYPE	CAT. NO.	QTY. per pk.	PAGE	TYPE	CAT. NO.	QTY. per pk.	PAGE
PTC/5/00	PTC0500	8	128	SCB/10/PT	SB401	25	47	SFR.6/M (EX)I	SR600	50	34
PTC/5/02	PTC0502	25	128	SCB/4/CPM	SB305	25	151	SFR.6/M (EX)I	SR600	50	43
PTC/5/03	PTC0503	25	128	SCB/4/PO/2	SB303	40	151	SFR.6/M/GR	SR500GR	50	34
PTC/5/05	PTC0505	25	128	SCB/4/PO/4	SB304	20	151	SFR.6/M/GR	SR500GR	50	43
PTC/5/10	PTC0510	10	128	SCB/4/PT	SB301	25	44	SFR.6/PT	SR301	25	34
PTC/6/00	PTC0600	8	128	SCB/6/CPM	SB205	25	151	SFR.6/PT(EX)I	SR401	25	34
PTC/6/02	PTC0602	25	128	SCB/6/PO/2	SB203	40	151	SFR/PT	SF701	25	34
PTC/6/03	PTC0603	25	128	SCB/6/PO/4	SB204	20	151	SFR/PT(EX)I	SF801	25	34
PTC/6/05	PTC0605	25	128	SCB/6/PT	SB201	25	46	SH4/PT	DH401	25	136
PTC/6/10	PTC0610	10	128	SCX/CPM	SC105	40	151	SH5/PT	DH501	25	136
PTC/8/00	PTC0800	8	128	SCX/PO/2	SC103	40	151	SH6/PT	DH601	25	136
PTC/8/02	PTC0802	25	128	SCX/PO/4	SC104	20	151	SH7/PT	DH701	25	136
PTC/8/03	PTC0803	25	128	SD5/PT	DD501	25	136	SHZ.1	SH004	1500	147
PTC/8/05	PTC0805	25	128	SD6/PT	DD601	25	136	SHZ/1/00	SH004	1500	147
PTC/8/10	PTC0810	10	128	SDC/5	DC005	25	136	TAI/12	TA002	1	142
PTMS	PTMS	36	120	SDC/5V	DC05V	25	136	TAI/6	TA001	1	142
PTM	PTM	15	120	SDC/6	DC006	25	136	TC/PO	TC500	125	55
PZD.4/S0	PZ331	20	141	SDC/6P	DC06P	25	136	TC/PO (EX)I	TC510	125	55
PZD.6/S0	PZ112	10	141	SDC/6V	DC06V	25	136	TC/PO/GR	TC500GR	125	55
PZM.4	PZ330	2	141	SDC/POL	DCPOL	25	136	TDE.2	TL500	125	33
PZM.6	PZ110	2	141	SDD/1	DD001	50	137	TDE.2/GR	TL500GR	125	33
QBLOK.12/GR	QBLOK1203	10	101	SDD/2	DD002	50	137	TE.10/D	TE500	35	25
QBLOK.12/BLU	QBLOK1201	10	101	SDD/5	DD005	25	136	TE.10/O	T0500	35	25
QBLOK.12/TE	QBLOK1202	10	101	SDD/6	DD006	25	136	TE.16/D	TE210	30	26
QBLOK.7/GR	QBLOK7003	10	101	SDH/4	DH004	25	136	TE.16/O	T0210	30	26
QBLOK.7/BLU	QBLOK7001	10	101	SDH/5	DH005	25	136	TE.50/D	TE310	15	26
QBLOK.7/TE	QBLOK7002	10	101	SDH/6	DH006	25	136	TE.50/O	T0310	15	26
QBLOK4P100A7	QBLOK4100	2	104	SDH/7	DH007	25	136	TE.6/D	TE110	50	25
QBLOK4P125A11	QBLOK4125	1	104	SFR.4	SF900	70	34	TE.6/O	T0110	45	25
QBLOK4P125A15	QBLOK4126	1	104	SFR.4	SF900	70	43	TEC.10/O	T0510	35	8
RFI.2/GR	RF110GR	280	61	SFR.4	SF900	70	48	TEC.16/O	T0220	30	8
RFN/PT(EX)I	RF201	25	60	SFR.4 (EX)I	SF850	70	34	TEC.35/O	T0320	15	9
RFN/PT/GR	RF101GR	25	60-61	SFR.4 (EX)I	SF850	70	43	TEC.6/O	T0120	45	8
RN.1 (EX)I	RN400	125	60	SFR.4/C230	SF923	70	40	TEC.70/O	T0810	25	9
RN.1/GR	RN300GR	125	60	SFR.4/C48	SF948	70	40	TED.4	TE400	65	25
RN.2 (EX)I	RN510	110	60	SFR.4/D1A	SF901	70	48	TEO.2	T0910	75	24
RN.2/GR	RN500GR	110	60	SFR.4/D1/GR	SF901GR	70	48	TEO.4	T0430	50	24
RP.4 (EX)I	RP400	200	60	SFR.4/D1	SFR901	70	48	TEO.4/PT	T0431	25	24
RP.4/GR	RP300GR	200	60	SFR.4/D3/GR	SF903GR	70	48	TH/3	TH03	50	143
RP.4/PT(EX)I	RP401	25	60	SFR.4/D3	SFR903	70	48	TH/2	TH02	50	143
RP.4/PT/GR	RP301GR	25	60	SFR.4/D3A	SF903	70	48	TLD.2	TL200	125	33
SCB.10	SB400	80	47	SFR.4/GR	SF900GR	70	34	TLD.2 (EX)I	TL300	125	33
SCB.10/CD	SB420	80	47	SFR.4/GR	SF900GR	70	43	TLD.2/GR	TL200GR	125	33
SCB.10/CD/GR	SB420GR	80	47	SFR.4/GR	SF900GR	70	48	TLD/PT	TL201	25	33
SCB.10/DD	SB410	80	47	SFR.4/VS	SF910	50	35	TLE.2	TL400	200	33
SCB.10/DD/GR	SB410GR	80	47	SFR.4/VS	SF910	50	43	TLE.2/GR	TL400GR	200	33
SCB.10/GR	SB400GR	80	47	SFR.4/VS/GR	SF910GR	50	35	TLS.2	TL100	200	32
SCB.4	SB300	75	44	SFR.6	SR300	50	35	TLS.2/GR	TL100GR	200	32
SCB.4/GR	SB300GR	75	44	SFR.6	SR300	50	44	TLS.2/T	TL120	20	32
SCB.6	SB200	100	46	SFR.6 (EX)I	SR400	50	35	TLS.2/U	TL110	20	32
SCB.6/CD	SB220	80	46	SFR.6 (EX)I	SR400	50	44	TLS/PT	TL101	25	33
SCB.6/CD/GR	SB220GR	80	46	SFR.6/GR	SR300GR	50	35	TPL.4	TP100	40	63
SCB.6/DD	SB210	80	46	SFR.6/GR	SR300GR	50	44	TPL.4/PS	TP200	40	64
SCB.6/DD/GR	SB210GR	80	46	SFR.6/M	SR500	50	34	TQM/02	TQM02	10	142
SCB.6/GR	SB200GR	100	46	SFR.6/M	SR500	50	43	TQM/04	TQM04	10	142

Index for marking

TYPE	CAT. NO.	QTY. per pk.	PAGE
TQM/12	TQM12	10	142
TQM/13	TQM13	10	142
TQM/14	TQM14	10	142
TQM/15	TQM15	10	142
TR.2	TR110	100	61
TR.2/PT	TR111	25	61
TR.4	TR200	50	61
TTM/12	TTM12	10	142
TUM/05	TUM05	10	142
TUM/06	TUM06	10	142
TUM/07	TUM07	10	142
TUM/08	TUM08	10	142
TUM/16	TUM16	10	142
UMCT	UMCT3149	1	112
UMPI1525	UMCT3129	1	112
UMPI4060	UMCT3128	1	112
UMPU02510	UMCT3127	1	112
UMPU1625	UMCT3153	1	112
UMPU3550	UMCT3154	1	112
VPC.2	VP300	120	56
VPC.2 (EX)I	VP310	120	56
VPC.2/GR	VP300GR	120	56
VPC/F02	VP902	10	56-57-87
VPC/F03	VP903	10	56-57-87
VPC/F04	VP904	10	56-57-87
VPC/F05	VP905	10	56-57-87
VPC/F06	VP906	10	56-57-87
VPC/F07	VP907	10	56-57-87
VPC/F08	VP908	10	56-57-87
VPC/F09	VP909	10	56-57-87
VPC/F10	VP910	10	56-57-87
VPC/F11	VP911	10	56-57-87
VPC/F12	VP912	10	56-57-87
VPC/F13	VP913	10	56-57-87
VPC/F14	VP914	10	56-57-87
VPC/F15	VP915	10	56-57-87
VPC/F16	VP916	10	56-57-87
VPC/PT	VP101	25	56
VPC/PT	VP101	25	56
VPC/PT(EX)I	VP201	25	56
VPC/PTF	VP303	25	56
VPC/VT	VP102	25	56
VPD.2 (EX)I	VP560	40	57
VPD.2/GR	VP500GR	40	57
VPD/PT	VP501	25	57
VPD/PT(EX)I	VP561	25	57
WP1-14	WP30009	500	113
WP100-21	WP30024	100	113
WP15-14	WP30013	500	113
WP160-22	WP30026	100	113
WP25-14	WP30016	500	113
WP250-29	WP30028	50	113
WP350-30	WP30030	50	113
WP40-16	WP30019	500	113
WP5-14	WP30002	500	113

TYPE	CAT. NO.	QTY. per pk.	PAGE
WP500-40	WP30032	50	113
WP60-20	WP30022	100	113
WP75-14	WP30005	500	113
WPD01/15	WP90003	500	113
WPD04/23	WP90006	100	113
WPD05/15	WP90001	500	113
WPD15/16	WP90004	500	113
WPD25/18	WP90005	250	113
WPD75/15	WP90002	500	113

Index by Catalogue number

A

CAT. NO.	TYPE	QTY. per pk.	PAGE
AC100	ACB.70/BB	12	21
AC400	ACB.120/BB	12	21
AC700	ACB.185/BB	12	21
AF201	AFO/PT	50	53
AF201GR	AFO/PT	50	118
AF400	AFO.2/2+2	100	53
AF410	AFO.2/2+2/TP	100	53
AF500	AFO.2/1+1	100	53

B

BP100	BPL.4	60	63
BP200	BPL/R	100	63
BP300	BPL.4/PS	60	64
BP310	BPL.4/PS/A	60	64
BT003	BT/3	25	119
BT005	BTU	25	119
BT006	BT/2	25	119
BT007	BTO	25	119

C

CAMUT02	CAMUT.12/02	10	111
CAMUT04	CAMUT.12/04	10	111
CAMUT06	CAMUT.12/06	10	111
CAMUT10	CAMUT.12/10	10	111
CAMUT16	CAMUT.12/16	10	111
CAMUT25	CAMUT.12/25	10	111
CB009	CBD/SH	10	151
CB110	CBD.2	120	13
CB111	CB2/PT	50	55
CB111GR	CB2/PT/GR	50	55
CB240	CBD.4	100	13
CB241	CB4/6/PT	25	13
CB340	CBD.6	100	13
CB401	CB/PT	25	41
CB401GR	CB/PT/GR	25	34
CB402	CB/PT(Ex)i	25	34
CB431	CB10/PT	25	14
CB440	CBD.10	100	14
CB510	CBD.16	50	14
CB511	CB16/PT	25	14
CB518	CIL/CBF/12-48	10	34
CB523	CIL/CBF/110-230	10	34
CB610	CBD.35	75	14
CB611	CB35/PT	25	14
CB710	CBD.50	50	15
CB711	CB50/PT	10	15
CB810	CBD.70	40	15
CB811	CB70/PT	10	15
CBC02GR	CBC.2/GR	120	3
CBC04GR	CBC.4/GR	100	3
CBC06GR	CBC.6/GR	100	3
CBC10GR	CBC.10/GR	100	4
CBC16GR	CBC.16/GR	50	4
CBC35GR	CBC.35/GR	50	4
CBF448GR	CBF.4/C48/GR	50	40
CBF423GR	CBF.4/C230/GR	50	40
CBF04I	CBF.4 (Ex)i	50	34

CAT. NO.	TYPE	QTY. per pk.	PAGE
CBF04GR	CBF.04/GR	50	34
CBI02	CBC.2 (EX)I	120	3
CBI04	CBC.4 (EX)I	100	3
CBI06	CBC.6 (EX)I	100	3
CBI061	CBC.2-10/PT(EX)I	50	4
CBI10	CBC.10 (EX)I	100	4
CBI16	CBC.16 (EX)I	50	4
CBI161	CBC.16/PT(EX)I	25	4
CBI35	CBC.35 (EX)I	50	4
CBI351	CBC.35/PT(EX)I	25	4
CBS02I	CBS.2 (Ex)i	100	41
CBS02GR	CBS.2/GR	100	41
CBS02	CBS.2	100	41
CBS04I	CBS.4 (Ex)i	80	41
CBS04GR	CBS.4/GR	80	41
CBS04	CBS.4	80	41
CBX12	CBD.2 (EX)I	120	13
CBX13	CB2/PT(EX)I	50	55
CBX24	CBD.4 (EX)I	100	13
CBX25	CB4/6/PT(EX)I	25	13
CBX34	CBD.6 (EX)I	100	13
CBX44	CB10/PT(EX)I	25	14
CBX45	CBD.10 (EX)I	100	14
CBX52	CBD.16 (EX)I	50	14
CBX53	CB16/PT(EX)I	25	14
CBX62	CBD.35 (EX)I	75	14
CBX63	CB35/PT(EX)I	25	14
CBX72	CBD.50 (EX)I	50	15
CBX73	CB50/PT(EX)I	10	15
CBX82	CBD.70 (EX)I	40	15
CBX83	CB70/PT(EX)I	10	15
CCH02	CCH/2.5-4	1	112
CCH06	CCH/6	1	112
CCV03	CCV/2.5	1	112
CCV04	CCV/4	1	112
CCV05	CCV/5	1	112
CE110	CBE.2	70	24
CF200	CF.12/2+2	25	66
CF301	CF/PTM	25	65
CF400	CF.08/2+2	40	66
CF900	CF.12/CPT	40	65
CNT06	CNT.6	40	67
CNT16	CNT.16	25	67
CNT35	CNT.35	15	67
CONT206	CONTC/2/6	20	108
CONT216	CONTC/2/16	20	108
CONT225	CONTC/2/25	10	108
CONT235	CONTC/2/35	5	108
CONT306	CONTC/3/6	10	109
CONT316	CONTC/3/16	5	109
CONT506	CONTC/5/6	10	110
CONT516	CONTC/5/16	5	110
CONT525	CONTC/5/25	5	110

D

CAT. NO.	TYPE	QTY. per pk.	PAGE
CONTC01		10	107
CONTC02		10	107
CONTC04	CONTC/4	10	107
CONTC06	CONTC/6	10	107
CONTC10	CONTC/10	5	107
CONTC16	CONTC/16	5	107
CONTC25	CONTC/25	5	107
CONTC35	CONTC/35	5	107
CPF05	CPF/5	20	38
CPF05	CPF/5	20	85
CPM01	CPM/01	25	134
CPM03	CPM/03	25	134
CPM06	CPM/06	10	134
CPM07	CPM/07	10	134
CPM08	CPM/08	10	134
CPM12	CPM/12	25	134
CPM16	CPM/16	25	134
CPM17	CPM/17	25	134
CPM21	CPM/21	25	134
CPM21	CPM/21	25	134
CPM25	CPM/25	25	134
CPM25	CPM/25	25	134
CPM44	CPM/44	25	134
CPM53	CPM/53	25	134
CPM57	CPM/57	25	134
CPM70	CPM/70	25	134
CPM83	CPM/83	25	134
CPM99	CPM/99	25	134
CPX01	CPX/01	25	134
CPX03	CPX/03	25	134
CPX06	CPX/06	10	134
CPX07	CPX/07	10	134
CPX08	CPX/08	10	134
CPX12	CPX/12	25	134
CPX21	CPX/21	25	134
CPX44	CPX/44	25	134
CPX83	CPX/83	25	134
CR110	CBR.2	75	5
CR110GR	CBR.2/GR	75	5
CR111	CBR/PT	25	5
CV100	CVF.4	100	54
CV101	CVF/PT	25	54
CV200	CVF.4 (EX)I	100	54
CV201	CVF/PT(EX)I	25	54
DA100	DSFA.4	100	37
DA100GR	DSFA.4/GR	100	37
DA112	DSFA.4/L12	100	37
DA124	DSFA.4/L24	100	37
DA200GR	DSF.4/GR	80	36
DB100	DBC.2	120	27
DB100GR	DBC.2/GR	120	27
DB101	DBC/PT	25	27
DB117	DBC.2/CI	120	27

Index by Catalogue number

CAT. NO.	TYPE	QTY. per pk.	PAGE	CAT. NO.	TYPE	QTY. per pk.	PAGE	CAT. NO.	TYPE	QTY. per pk.	PAGE	
DB117GR	DBC.2/CI/GR	120	27	DS114GR	DAS.4/D/GR	20	52	FN001ST	F5/100 MA	100	138	
DB200	DBC.2 (EX)I	120	27	DS115	DAS.4/E	20	52	FN002ST	F5/200 MA	100	138	
DB201	DBC/PT(EX)I	25	27	DS115GR	DAS.4/E/GR	20	52	FN003ST	F5/315 MA	100	138	
DB400GR	DBC.4GR	100	28	DS117	DAS.4/CI	120	29	FN004ST	F5/500 MA	100	138	
DB401GR	DBC.4/PT/GR	25	28	DS117GR	DAS.4/CI/GR	120	29	FN005ST	F5/630 MA	100	138	
DB402	DBC.4/PT (Ex)I	25	28	DS119	DAS.4/I	20	52	FN006ST	F5/1 A	100	138	
DB417GR	DBC.4/CI/GR	100	28	DS119GR	DAS.4/I/GR	20	52	FN007ST	F5/1.6 A	100	138	
DB500	DBC.4(Ex)I	100	28	DS120	DAS.4/DD	20	52	FN008ST	F5/2 A	100	138	
DB517	DBC.4/CI(Ex)I	100	28	DS120GR	DAS.4/DD/GR	20	52	FN009ST	F5/2.5 A	100	138	
DC005	SDC/5	25	136	DS128	DAS.4/T	20	52	FN010ST	F5/3.15 A	100	138	
DC006	SDC/6	25	136	DS128GR	DAS.4/T/GR	20	52	FN011ST	F5/4 A	100	138	
DC05V	SDC/5V	25	136	DS129	DAS.4/U	20	52	FN012ST	F5/5 A	100	138	
DC06P	SDC/6P	25	136	DS129GR	DAS.4/U/GR	20	52	FN013ST	F5/6.3 A	100	138	
DC06V	SDC/6V	25	136	DS130	DAS.4/L	20	52	FN014ST	F5/8 A	100	138	
DCPOL	SDC/POL	25	136	DS130GR	DAS.4/L/GR	20	52	FN015ST	F5/10 A	100	138	
DD001	SDD/1	50	137	DS200	DAS.4 (EX)I	120	29	FN016ST	F5/12 A	100	138	
DD002	SDD/2	50	137	DS201	DAS/PT(EX)I	25	29	FP100	FPC.10	70	39	
DD005	SDD/5	25	136	DS217	DAS.4/CI (EX)I	120	29	FP100	FPC.10	70	44	
DD006	SDD/6	25	136	DS301	DSS/PT	25	37	FP200	FPL.10/L	70	39	
DD501	SD5/PT	25	136	DS400	DSS.4	100	30	FP300	FPL.10/C	70	39	
DD601	SD6/PT	25	136	DS400	DSS.4	100	42	FP923	FPL.10/C230	70	40	
DF300	DFM/300	50	140	DS400GR	DSS.4/GR	100	30	FP948	FPL.10/C48	70	40	
DF400	DFM/400	50	140	DS400GR	DSS.4/GR	100	42	FV100	FVS.4	120	31	
DF500	DFM/500	50	140	DS401GR	DFS.4/PT/GR	25	36	FV100GR	FVS.4/GR	120	31	
DF600	DFM/600	50	140	DSD005	DAS.4/D5	20	50	FV101	FVS/PT	25	31	
DF700	DFM/700	50	140	DSD005GR	DAS.4/D5/GR	20	50	FV107	FVS/VCI	25	151	
DF800	DFM/800	50	140	DSD012	DAS.4/D12	20	50	FV108	FVS/VCE	25	151	
DF900	DFM/900	50	140	DSD012GR	DAS.4/D12/GR	20	50	G	GA100	GPA.95	10	6
DFP2R	DFP/2/RED	50	139	DSD024	DAS.4/D24	20	50	GA100GR	GPA.95/GR	10	6	
DH004	SDH/4	25	136	DSD024GR	DAS.4/D24/GR	20	50	GA200	GPA.150	8	7	
DH005	SDH/5	25	136	DSD060	DAS.4/D60	20	50	GA200GR	GPA.150/GR	8	7	
DH006	SDH/6	25	136	DSD060GR	DAS.4/D60/GR	20	50	GA300	GPA.240	4	7	
DH007	SDH/7	25	136	DSV024	DAS.4/V24	20	51	GA300GR	GPA.240/GR	4	7	
DH01R	DFH/1/RED	25	139	DSV024GR	DAS.4/V24/GR	20	51	GA400	GPA.70	25	6	
DH02R	DFH/2/RED	25	139	DSV048	DAS.4/V48	20	51	GA400GR	GPA.70/GR	25	6	
DH03R	DFH/3/RED	25	139	DSV048GR	DAS.4/V48/GR	20	51	GF100	GPA.95/FIX	10	6	
DH04R	DFH/4/RED	25	139	DSV120	DAS.4/V120	20	51	GF100GR	GPA.95/FIX/GR	10	6	
DH401	SH4/PT	25	136	DSV120GR	DAS.4/V120/GR	20	51	GF200	GPA.150/FIX	8	7	
DH501	SH5/PT	25	136	DSV230	DAS.4/V230	20	51	GF300	GPA.240/FIX	4	7	
DH601	SH6/PT	25	136	DSV230GR	DAS.4/V230/GR	20	51	GF400	GPA.70/FIX	25	6	
DH701	SH7/PT	25	136	DU01R	DFU/1/RED	50	139	GF400GR	GPA.70/FIX/GR	25	6	
DS100	DAS.4	120	29	DU02R	DFU/2/RED	50	139	GP100	GPM.95/BB	10	17	
DS100GR	DAS.4/GR	120	29	DU02S	DF/VPC	25	56	GP100GR	GPM.95/BB/GR	10	17	
DS101	DAS/PT	25	29	DU03R	DFU/3/RED	50	139	GP110	GPM.95/BB/FIX	10	17	
DS107	DAS/VCI	25	151	DU04R	DFU/4/RED	50	139	GP110GR	GPM.95/BB/FIX/GR	10	17	
DS108	DAS/VCE	25	151	DU05R	DFU/5/RED	25	139	GP120	GPM.95/O/BB		18	
DS110	DAS.4/SS	20	30	DU06R	DFU/6/RED	25	139	GP125	GPM.95/C/BB		18	
DS110GR	DAS.4/SS/GR	20	30	DU07R	DFU/7/RED	25	139	GP130	GPM.95/O/BB/FIX		18	
DS111	DAS.4/A	20	52	F	FC103	MSM	10	142	GP135	GPM.95/C/BB/FIX		18
DS111GR	DAS.4/A/GR	20	52	FD100	FDP.2	70	54	GP200	GPM.95/BC	10	19	
DS112	DAS.4/B	20	52	FD100GR	FDP.2/GR	70	54	GP210	GPM.95/BC/FIX	10	19	
DS112GR	DAS.4/B/GR	20	52	FD101	FDP/PT	25	54	GP300	GPM.95/CC	10	20	
DS113	DAS.4/C	20	52	FF100	FFS.4	120	31	GP310	GPM.95/CC/FIX	10	20	
DS113GR	DAS.4/C/GR	20	52	FF100GR	FFS.4/GR	120	31	GP400	GPM.150/BB	6	17	
DS114	DAS.4/D	20	52	FF101	FFS/PT	25	31	GP400GR	GPM.150/BB/GR	6	17	

Index by Catalogue number

CAT. NO.	TYPE	QTY. per pk.	PAGE
GP410	GPM.150/BB/FIX	6	17
GP410GR	GPM.150/BB/FIX/GR	6	17
GP420	GPM.150/O/BB		18
GP425	GPM.150/C/BB		18
GP430	GPM.150/O/BB/FIX		18
GP435	GPM.150/C/BB/FIX		18
GP500	GPM.150/BC	6	19
GP510	GPM.150/BC/FIX	4	19
GP600	GPM.150/CC	6	20
GP610	GPM.150/CC/FIX	6	20
GP700	GPM.240/BB	4	17
GP700GR	GPM.240/BB/GR	4	17
GP710	GPM.240/BB/FIX	4	17
GP710GR	GPM.240/BB/FIX/GR	4	17
GP720	GPM.240/O/BB		18
GP725	GPM.240/C/BB		18
GP730	GPM.240/O/BB/FIX		18
GP735	GPM.240/C/BB/FIX		18
GP800	GPM.240/BC	4	19
GP810	GPM.240/BC/FIX	4	19
GP900	GPM.240/CC	4	20
GP910	GPM.240/CC/FIX	4	20
HB100GR	HSCB.4/GR	90	84
HB101GR	HSCB.4/PT/GR	25	90
HB200GR	HSCB.6/GR	60	84
HB201GR	HSCB.6/PT/GR	25	84
HB203	HSCB.6/PO/2	40	151
HB204	HSCB.6/PO/4	20	151
HB205	HSCB.6/CPM	40	151
HB403	HSCB.4/PO/2	40	84
HB404	HSCB.4/PO/4	20	84
HB405	HSCB.4/CPM	40	84
HC200GR	HCD.1/GR	40	87
HC201GR	HCD.1/PT/GR	25	87
HC210	HCD.1 (EX)I	40	87
HD100GR	HMD.2/GR	60	80
HD101GR	HMD/PT/GR	25	80
HD120GR	HMD.1/CI/GR	50	80
HD130GR	HMD.1/X/GR	50	81
HD200GR	HMD.1/GR	50	80
HD201GR	HMD.1/PT/GR	25	80
HD300	HMD.1 (EX)I	50	80
HD400GR	HMD.2N/GR	40	80
HD410	HMD.2N (EX)I	40	80
HD420GR	HMD.2N/DD/GR	40	81
HD430GR	HMD.2N/3DC/GR	40	81
HD440GR	HMD.2N/X/GR	40	81
HD441GR	HMD.2N/X1/GR	40	82
HD450GR	HMD.2N/CI/GR	40	80
HF210GR	HFR.4/GR	70	86
HF211GR	HFR.4/PT/GR	25	86
HF300GR	HMFA.2/GR	80	85
HF310GR	HFR.4/M/GR	100	86
HI130	HP.2 (EX)I	100	90
HI131	HPC.2 (EX)I	100	91

CAT. NO.	TYPE	QTY. per pk.	PAGE
HI132	HPP.2 (EX)I	100	90
HI210	HMM.4/1+2 (EX)I	40	73
HI220	HMM.4/2+2 (EX)I	20	73
HI250	HMM.4 (EX)I	60	73
HI251	HMT.4/PT(EX)I	25	73
HI320	HMM.6 (EX)I	30	74
HI321	HMT.6/PT(EX)I	25	74
HI330	HMM.10 (EX)I	30	74
HI340	HMM.16 (EX)I	30	74
HI400	HMM.1 (EX)I	100	70
HI401	HMT.1/PT(EX)I	25	70
HI410	HMM.1/1+2 (EX)I	80	70
HI411	HMT.1/1+2/PT(EX)I	25	70
HI420	HMM.1/2+2 (EX)I	60	70
HI421	HMT.1/2+2/PT(EX)I	25	70
HI500	HMM.2 (EX)I	80	71
HI501	HMT.2/PT(EX)I	25	71
HI510	HMM.2/1+2 (EX)I	80	71
HI511	HMT.2/1+2/PT(EX)I	25	71
HI520	HMM.2/2+2 (EX)I	60	71
HI521	HMT.2/2+2/PT(EX)I	25	71
HL200GR	HLD.2/GR	50	83
HL201GR	HLD.2/PT/GR	25	83
HL210GR	HLD.2/CI/GR	50	83
HL500GR	HDE.2/GR	50	83
HLT500	HTTE.2	50	83
HM170GR	HMM.2/2+2/A/GR	60	72
HM210GR	HMM.4/1+2/GR	40	73
HM220GR	HMM.4/2+2/GR	40	73
HM250GR	HMM.4/GR	60	73
HM251GR	HMT.4/PT	25	73
HM251GR	HMT.4/PT/GR	25	73
HM320GR	HMM.6/GR	30	74
HM321GR	HMT.6/PT	25	74
HM321GR	HMT.6/PT/GR	25	74
HM330GR	HMM.10/GR	30	74
HM340GR	HMM.16/GR	30	74
HM350GR	HMR.16/GR	15	75
HM360GR	HMR.16/D/GR	30	75
HM400GR	HMM.1/GR	100	70
HM401GR	HMT.1/PT	25	70
HM401GR	HMT.1/PT/GR	25	70
HM410GR	HMM.1/1+2/GR	80	70
HM411GR	HMT.1/1+2/PT	25	70
HM420GR	HMM.1/2+2/GR	60	70
HM421GR	HMT.1/2+2/PT	25	70
HM500GR	HMM.2/GR	80	71
HM501GR	HMT.2/PT	25	71
HM501GR	HMT.2/PT/GR	25	71
HM510GR	HMM.2/1+2/GR	80	71
HM511GR	HMT.2/1+2/PT	25	71
HM511GR	HMT.2/1+2/PT/GR	25	71
HM511GR	HMT.2/2+2/PT/GR	25	71
HM520GR	HMM.2/2+2/GR	60	71
HM521GR	HMT.2/1+2/PT/GR	25	71

CAT. NO.	TYPE	QTY. per pk.	PAGE
HM521GR	HMT.2/2+2/PT	25	71
HM521GR	HMT.2/2+2/PT/GR	25	71
HMS10GR	HMM.2/2+2/S/GR	60	72
HMS20GR	HMM.2/1+2/S/GR	80	72
HP150GR	HP.2/GR	100	90
HP160GR	HPC.2/GR	100	91
HP170GR	HPP.2/GR	100	90
HS200GR	HMS.2/GR	80	84
HT250	HTE.4	60	78
HT260	HTE.4/1+2	40	78
HT270	HTE.4/2+2	20	78
HT320	HTE.6	30	79
HT330	HTE.10	30	79
HT340	HTE.16	30	79
HT400	HTE.1	80	76
HT410	HTE.1/1+2	80	76
HT420	HTE.1/2+2	60	76
HT500	HTE.2	80	77
HT510	HTE.2/1+2	80	77
HT520	HTE.2/2+2	60	77
HV111GR	HPV/PT/GR	25	90
HVP300GR	HVPC.2/GR	120	88
HVP900GR	CHP.2/GR	20	88
HVP910GR	CHP.2D/GR	20	88
HVT500	HVTE.2	80	89
HVT900	CHTE.2	20	89
HVT910	CHTE.2D	20	89
INKBOTT1	INKBOTT1	1	147
INKCART5	INKCART5	1	147
KITPULIZIA	KITPULIZIA	1	147
KSLOTTER	KSLOTTER	1	147
MA010	MAC/PLZ	50	59
MA030	MAC/COS	25	59
MA040	MAC/CP8	20	59
MA100	MAC.6	80	58
MA110	CAM	100	59
MA111	CAM/B	100	59
MA112	CAM/C	80	59
MA200	MAC.6/N	80	58
MA410	MAC.6/FS	80	58
MB100	MBL.50/6	10	22
MB200	MBL.95/8	10	22
MB300	MBL.120/10	10	23
MB400	MBL.150/12	10	23
MC201B	MCM.1/B	1	95
MC201G	MCM.1/G	1	95
MC201R	MCM.1/R	1	95
MC202B	MCM.2/B	1	96
MC202G	MCM.2/G	1	96
MC202R	MCM.2/R	1	96
MC203B	MCM.3/B	1	96
MC203G	MCM.3/G	1	96
MC203R	MCM.3/R	1	96
MC233B	MCM.3/VE/B	1	97
MC233G	MCM.3/VE/G	1	97

Index by Catalogue number

CAT. NO.	TYPE	QTY. per pk.	PAGE	CAT. NO.	TYPE	QTY. per pk.	PAGE	CAT. NO.	TYPE	QTY. per pk.	PAGE
MC233R	MCM.3/VE/R	1	97	NU085110	CNU/8/025	500	148	NU0851Q	CNU/8/048	500	148
MC401B	MCT.1/SA/B	1	98	NU0851101	CNU/8/101	500	148	NU0851R	CNU/8/013	500	148
MC401G	MCT.1/SA/G	1	98	NU085112	CNU/8/024	500	148	NU0851S	CNU/8/014	500	148
MC401R	MCT.1/SA/R	1	98	NU085114	CNU/8/027	500	148	NU0851SP	CNU/8/51	500	150
MC402B	MCT.2/SA/B	1	98	NU0851151	CNU/8/151	500	148	NU0851T	CNU/8/015	500	148
MC402G	MCT.2/SA/G	1	98	NU08512	CNU/8/222	500	148	NU0851U	CNU/8/017	500	148
MC402R	MCT.2/SA/R	1	98	NU0851201	CNU/8/201	500	148	NU0851V	CNU/8/018	500	148
MC403B	MCT.3/SA/B	1	99	NU0851251	CNU/8/251	500	148	NU0851W	CNU/8/019	500	148
MC403G	MCT.3/SA/G	1	99	NU08513	CNU/8/333	500	148	NU0851X	CNU/8/020	500	148
MC403R	MCT.3/SA/R	1	99	NU0851301	CNU/8/301	500	148	NU0851Y	CNU/8/021	500	148
MF100	MPFA.4	100	37	NU0851351	CNU/8/351	500	148	NU0851Z	CNU/8/022	500	148
MF100GR	MPFA.4/GR	100	37	NU08514	CNU/8/444	500	148	NU0861	CNU/8/61	1200	143
MF112	MPFA.4/L12	100	37	NU0851401	CNU/8/401	500	148	NU0861SP	CNU/8/61	400	150
MF124	MPFA.4/L24	100	37	NU0851451	CNU/8/451	500	148	NU1051	CNU/10/51	1500	143
MP901	MPS.4/PT	25	37-42	NU08515	CNU/8/555	500	148	NU1051SP	CNU/10/51	500	150
MP902	MPS.4/PT(EX)	25	42	NU0851501	CNU/8/501	500	148	NU1061	CNU/10/61	1200	143
MP950	MPS.4	100	42	NU0851510	CNU/8/510	500	148	NU1061SP	CNU/10/61	400	150
MP950GR	MPS.4/GR	100	42	NU0851520	CNU/8/520	500	148	P PADCABUR	PADCABUR	1	147
MP960	MPS.4/SW (EX)	100	42	NU0851530	CNU/8/530	500	148	PADGRAPH	PADGRAPH	1	147
MZ300N	MS/8X10/N	1	100	NU0851540	CNU/8/540	500	148	PADMUTHO	PADMUTHO	1	147
MZ300T	MS/8X10/T	1	100	NU0851550	CNU/8/550	500	148	PD001	PSD/A	50	137
N NC100	NCS	100	93	NU0851551	CNU/8/551	500	148	PD002	PSD/B	50	137
NC101	NCS/PT	25	93	NU0851560	CNU/8/560	500	148	PD003	PSD/C	50	137
NC200	NCV	100	93	NU0851570	CNU/8/570	500	148	PD004	PSD/D	50	137
NU0851	CNU/8/51	1500	143	NU0851580	CNU/8/580	500	148	PD009	PSD/L	50	137
NU0851	CNU/8/030	1500	148	NU0851590	CNU/8/590	500	148	PD011	PSD/K	50	137
NU0851010	CNU/8/010	500	148	NU08516	CNU/8/666	500	148	PD013	PSD/N	50	137
NU0851011	CNU/8/11	500	148	NU0851600	CNU/8/600	500	148	PD014	PSD/J	50	137
NU0851012	CNU/8/12	500	148	NU0851601	CNU/8/601	500	148	PD015	PSD/P	50	137
NU0851013	CNU/8/13	500	148	NU0851651	CNU/8/651	500	148	PD017	PSD/O	50	137
NU0851014	CNU/8/14	500	148	NU08517	CNU/8/777	500	148	PEN025CAB	PEN025CAB	1	147
NU0851015	CNU/8/15	500	148	NU0851701	CNU/8/701	500	148	PEN035CAB	PEN035CAB	1	147
NU0851016	CNU/8/16	500	148	NU0851751	CNU/8/751	500	148	PEN035GRA	PEN035GRA	1	147
NU0851017	CNU/8/17	500	148	NU08518	CNU/8/888	500	148	PF100	PDF.2	75	54
NU0851018	CNU/8/18	500	148	NU0851801	CNU/8/801	500	148	PF101	PDF/PT	25	54
NU0851019	CNU/8/19	500	148	NU0851851	CNU/8/851	500	148	PH100	PH/2.5-4	25	132
NU0851020	CNU/8/20	500	148	NU08519	CNU/8/999	500	148	PH100	PH/2.5-4	25	132
NU085102A	CNU/8/2A	500	148	NU0851901	CNU/8/901	500	148	PHD02	PHD/2	25	132
NU0851051	CNU/8/051	500	148	NU0851951	CNU/8/951	500	148	PM100	PM/10/10	10	127
NU08510L1	CNU/8/L1	500	148	NU0851A	CNU/8/031	500	148	PM102	PM/10/2	25	127
NU08510L2	CNU/8/L2	500	148	NU0851B	CNU/8/032	500	148	PM103	PM/10/3	25	127
NU08510L3	CNU/8/L3	500	148	NU0851C	CNU/8/033	500	148	PM105	PM/10/5	25	127
NU08510NI	CNU/8/NI	500	148	NU0851D	CNU/8/034	500	148	PM110	PM/11/10	10	127
NU08510PE	CNU/8/PE	500	148	NU0851E	CNU/8/035	500	148	PM112	PM/11/2	25	127
NU08510R1	CNU/8/R1	500	148	NU0851F	CNU/8/036	500	148	PM113	PM/11/3	25	127
NU08510S1	CNU/8/S1	500	148	NU0851G	CNU/8/037	500	148	PM115	PM/11/5	25	127
NU08510S2	CNU/8/S2	500	148	NU0851H	CNU/8/038	500	148	PM120	PM/12/10	10	127
NU08510S3	CNU/8/S3	500	148	NU0851I	CNU/8/043	500	148	PM122	PM/12/2	25	127
NU08510U1	CNU/8/U1	500	148	NU0851J	CNU/8/049	500	148	PM123	PM/12/3	25	127
NU08510U2	CNU/8/U2	500	148	NU0851K	CNU/8/050	500	148	PM125	PM/12/5	25	127
NU08510V1	CNU/8/V1	500	148	NU0851L	CNU/8/044	500	148	PM202	PM/20/2	25	127
NU08510V2	CNU/8/V2	500	148	NU0851M	CNU/8/045	500	148	PM202	PM/20/2	25	127
NU08510W1	CNU/8/W1	500	148	NU0851N	CNU/8/016	500	148	PM203	PM/20/3	25	127
NU08510W2	CNU/8/W2	500	148	NU0851O	CNU/8/046	500	148	PM203	PM/20/3	25	127
NU08511	CNU/8/111	500	148	NU0851P	CNU/8/047	500	148	PM205	PM/20/5	25	127

Index by Catalogue number

CAT. NO.	TYPE	QTY. per pk.	PAGE	CAT. NO.	TYPE	QTY. per pk.	PAGE	CAT. NO.	TYPE	QTY. per pk.	PAGE
PM205	PM/20/5	25	127	P0953	POF/95/3	10	133	PTC0103	PTC/1/03	25	128
PM210	PM/20/10	10	127	POF06	POF/06	15	133	PTC0105	PTC/1/05	25	128
PM210	PM/20/10	10	127	POF07	POF/07	15	133	PTC0110	PTC/1/10	10	128
PM250	PM/25/10	10	127	POF08	POF/08	15	133	PTC0200	PTC/2/00	8	128
PM250	PM/25/10	10	127	POF11	POF/11	25	133	PTC0202	PTC/2/02	25	128
PM252	PM/25/2	25	127	POF12	POF/12	25	133	PTC0202	PTC/2/02	25	132
PM252	PM/25/2	25	127	POF13	POF/13	25	133	PTC0203	PTC/2/03	25	128
PM253	PM/25/3	25	127	POF14	POF/14	25	133	PTC0203	PTC/2/03	25	132
PM253	PM/25/3	25	127	POF17	POF/17	25	133	PTC0205	PTC/2/05	25	128
PM255	PM/25/5	25	127	POF44	POF/44	25	133	PTC0205	PTC/2/05	25	132
PM255	PM/25/5	25	127	POF53	POF/53	25	133	PTC0210	PTC/2/10	10	128
PM303	PM/30/3	25	127	POF54	POF/54	25	133	PTC0300	PTC/3/00	8	128
PM305	PM/30/5	25	127	POF55	POF/55	25	133	PTC0302	PTC/3/02	25	128
PM310	PM/30/10	10	127	POF56	POF/56	25	133	PTC0303	PTC/3/03	25	128
PM400	PM/40/10	10	127	POF57	POF/57	25	133	PTC0305	PTC/3/05	25	128
PM402	PM/40/2	25	127	POF70	POF/70	25	133	PTC0310	PTC/3/10	10	128
PM403	PM/40/3	25	127	POF99	POF/99	25	133	PTC0400	PTC/4/00	8	128
PM405	PM/40/5	25	127	POMPASP	POMPASP	1	147	PTC0402	PTC/4/02	25	128
PM410	PM/41/10	10	127	POS08	POS/08	15	135	PTC0403	PTC/4/03	25	128
PM412	PM/41/2	25	127	POS11	POS/11	25	135	PTC0405	PTC/4/05	25	128
PM413	PM/41/3	25	127	POS41	POS/41	25	135	PTC0410	PTC/4/10	10	128
PM415	PM/41/5	25	127	POS42	POS/42	25	135	PTC0500	PTC/5/00	8	128
PM510	PM/51/10	10	127	POS43	POS/43	25	135	PTC0502	PTC/5/02	25	128
PM513	PM/51/3	25	127	POS44	POS/44	25	135	PTC0503	PTC/5/03	25	128
PM515	PM/51/5	25	127	POS53	POS/53	15	135	PTC0505	PTC/5/05	25	128
PM602	PM/60/2	25	127	POS66	POS/66	25	135	PTC0510	PTC/5/10	10	128
PM603	PM/60/3	25	127	POS72	POS/72	25	135	PTC0600	PTC/6/00	8	128
PM605	PM/60/5	25	127	POS93	POS/93	25	135	PTC0602	PTC/6/02	25	128
PM610	PM/60/10	10	127	PR001	PR/DIN/AC	20	122	PTC0603	PTC/6/03	25	128
PM900	PM/90/10	10	127	PR002	PR/DIN/AL	20	122	PTC0605	PTC/6/05	25	128
PM902	PM/90/2	25	127	PR003	PR/3/AC	40	121	PTC0610	PTC/6/10	10	128
PM903	PM/90/3	25	127	PR004	PR/DIN/AS	20	122	PTC0800	PTC/8/00	8	128
PM905	PM/90/5	25	127	PR005	PR/3/AS	40	121	PTC0802	PTC/8/02	25	128
PM910	PM/91/10	10	127	PR006	PR/3/PA	20	121	PTC0803	PTC/8/03	25	128
PM912	PM/91/2	25	127	PR007	PR/3/PP	20	121	PTC0805	PTC/8/05	25	128
PM913	PM/91/3	25	127	PR009	PR/2/AC	100	122	PTC0810	PTC/8/10	10	128
PM915	PM/91/5	25	127	PR010	PR/2/AS	100	122	PTC1000	PTC/10/00	8	128
PMP01	PMP/01	8	134	PR901	PR/DIN/AC/ZB	20	122	PTC1002	PTC/10/02	25	128
PMP02	PMP/02	8	134	PR903	PR/3/AC/ZB	40	121	PTC1003	PTC/10/03	25	128
PMP04	PMP/04	8	134	PR904	PR/DIN/AS/ZB	20	122	PTC1005	PTC/10/05	25	128
PMP05	PMP/05	8	134	PR905	PR/3/AS/ZB	40	121	PTC1010	PTC/10/10	10	128
PMP06	PMP/06	8	134	PR906	PR/3/PA/ZB	20	121	PTC1100	PTC/11/00	8	128
PMP07	PMP/07	8	134	PR907	PR/3/PP/ZB	20	121	PTC1102	PTC/11/02	25	128
PMP08	PMP/08	8	134	PR909	PR/2/AC/ZB	100	122	PTC1103	PTC/11/03	25	128
PMP13	PMP/13	8	134	PR910	PR/2/AS/ZB	100	122	PTC1105	PTC/11/05	25	128
PMP16	PMP/16	8	134	PRP05	PRP/5	10	141	PTC1110	PTC/11/10	10	128
PMP17	PMP/17	8	134	PRP06	PRP/6	10	141	PTC1600	PTC/16/00	8	128
PMP25	PMP/25	8	134	PRP07	PRP/7	10	141	PTC1602	PTC/16/02	25	128
PMP42	PMP/42	8	134	PRP070G	PRP/7/G	10	142	PTC1603	PTC/16/03	25	128
PMP58	PMP/58	8	134	PRP08	PRP/8	10	141	PTC1605	PTC/16/05	25	128
P0152	POF/150/2	10	133	PRT01	PRT/P	20	140	PTC1610	PTC/16/10	10	128
P0153	POF/150/3	10	133	PRT02	PRT/M	15	140	PTC2000	PTC/20/00	8	128
P0242	POF/240/2	10	133	PRT03	PRT/G	10	140	PTC2002	PTC/20/02	25	128
P0243	POF/240/3	10	133	PTC0100	PTC/1/00	8	128	PTC2003	PTC/20/03	25	128
P0952	POF/95/2	10	133	PTC0102	PTC/1/02	25	128	PTC2005	PTC/20/05	25	128

Index by Catalogue number

CAT. NO.	TYPE	QTY. per pk.	PAGE	CAT. NO.	TYPE	QTY. per pk.	PAGE	CAT. NO.	TYPE	QTY. per pk.	PAGE
PTC2010	PTC/20/10	10	128	SC104	SCX/PO/4	20	151	TL101	TLS/PT	25	33
PTMS	PTMS	36	120	SC105	SCX/CPM	40	151	TL110	TLS.2/U	20	32
PTM	PTM	15	120	SF510	CIL/115-230	10	138	TL120	TLS.2/T	20	32
PZ110	PZM.6	2	141	SF518	CIL/12-48	10	138	TL200	TLD.2	125	33
PZ112	PZD.6/SO	10	141	SF701	SFR/PT	25	34	TL200GR	TLD.2/GR	125	33
PZ330	PZM.4	2	141	SF801	SFR/PT(EX)I	25	34	TL201	TLD/PT	25	33
PZ331	PZD.4/SO	20	141	SF850	SFR.4 (EX)I	70	34	TL300	TLD.2 (EX)I	125	33
QBLOK1201	QBLOK.12/BLU	10	101	SF850	SFR.4 (EX)I	70	43	TL400	TLE.2	200	33
QBLOK1202	QBLOK.12/TE	10	101	SF900	SFR.4	70	34	TL400GR	TLE.2/GR	200	33
QBLOK1203	QBLOK.12/GR	10	101	SF900	SFR.4	70	43	TL500	TDE.2	125	33
QBLOK4100	QBLOK4P100A7	2	104	SF900	SFR.4	70	48	TL500GR	TDE.2/GR	125	33
QBLOK4125	QBLOK4P125A11	1	104	SF900GR	SFR.4/GR	70	34	T0110	TE.6/0	45	25
QBLOK4126	QBLOK4P125A15	1	104	SF900GR	SFR.4/GR	70	43	T0120	TEC.6/0	45	8
QBLOK7001	QBLOK.7/BLU	10	101	SF900GR	SFR.4/GR	70	48	T0210	TE.16/0	30	26
QBLOK7002	QBLOK.7/TE	10	101	SF901	SFR.4/D1A	70	48	T0220	TEC.16/0	30	8
QBLOK7003	QBLOK.7/GR	10	101	SF901GR	SFR.4/D1/GR	70	48	T0310	TE.50/0	15	26
QPOL1203	POLM.1215	10	106	SF903	SFR.4/D3A	70	48	T0320	TEC.35/0	15	9
QPOL1204	POLM.1215/TE	10	106	SF903GR	SFR.4/D3/GR	70	48	T0430	TE0.4	50	24
QPOL1205	POLM.1215/BLU	10	106	SF910	SFR.4/VS	50	35	T0431	TE0.4/PT	25	24
RF101GR	RFN/PT/GR	25	60-61	SF910	SFR.4/VS	50	43	T0500	TE.10/0	35	25
RF110GR	RFI.2/GR	280	61	SF910GR	SFR.4/VS/GR	50	35	T0510	TEC.10/0	35	8
RF201	RFN/PT(EX)I	25	60	SF923	SFR.4/C230	70	40	T0810	TEC.70/0	25	9
RN300GR	RN.1/GR	125	60	SF948	SFR.4/C48	70	40	T0910	TE0.2	75	24
RN400	RN.1 (EX)I	125	60	SFR901	SFR.4/D1	70	48	TP100	TPL.4	40	63
RN500GR	RN.2/GR	110	60	SFR903	SFR.4/D3	70	48	TP200	TPL.4/PS	40	64
RN510	RN.2 (EX)I	110	60	SH004	SHZ.1	1500	147	TQM02	TQM/02	10	142
RP300GR	RP.4/GR	200	60	SH004	SHZ/1/00	1500	147	TQM04	TQM/04	10	142
RP301GR	RP.4/PT/GR	25	60	SR300	SFR.6	50	35	TQM12	TQM/12	10	142
RP400	RP.4 (EX)I	200	60	SR300	SFR.6	50	44	TQM13	TQM/13	10	142
RP401	RP.4/PT(EX)I	25	60	SR300GR	SFR.6/GR	50	35	TQM14	TQM/14	10	142
SB200	SCB.6	100	46	SR300GR	SFR.6/GR	50	44	TQM15	TQM/15	10	142
SB200GR	SCB.6/GR	100	46	SR301	SFR.6/PT	25	34	TR110	TR.2	100	61
SB201	SCB.6/PT	25	46	SR400	SFR.6 (EX)I	50	35	TR111	TR.2/PT	25	61
SB203	SCB.6/PO/2	40	151	SR400	SFR.6 (EX)I	50	44	TR200	TR.4	50	61
SB204	SCB.6/PO/4	20	151	SR401	SFR.6/PT(EX)I	25	34	TTM12	TTM/12	10	142
SB205	SCB.6/CPM	25	151	SR500	SFR.6/M	50	34	TUM05	TUM/05	10	142
SB210	SCB.6/DD	80	46	SR500	SFR.6/M	50	43	TUM06	TUM/06	10	142
SB210GR	SCB.6/DD/GR	80	46	SR500GR	SFR.6/M/GR	50	34	TUM07	TUM/07	10	142
SB220	SCB.6/CD	80	46	SR500GR	SFR.6/M/GR	50	43	TUM08	TUM/08	10	142
SB220GR	SCB.6/CD/GR	80	46	SR600	SFR.6/M (EX)I	50	34	TUM16	TUM/16	10	142
SB300	SCB.4	75	44	SR600	SFR.6/M (EX)I	50	43	UMCT3127	UMPU02510	1	112
SB300GR	SCB.4/GR	75	44	TA001	TAI/6	1	142	UMCT3128	UMPI4060	1	112
SB301	SCB.4/PT	25	44	TA002	TAI/12	1	142	UMCT3129	UMPI1525	1	112
SB303	SCB.4/PO/2	40	151	TC500	TC/PO	125	55	UMCT3149	UMCT	1	112
SB304	SCB.4/PO/4	20	151	TC500GR	TC/PO/GR	125	55	UMCT3153	UMPU1625	1	112
SB305	SCB.4/CPM	25	151	TC510	TC/PO (EX)I	125	55	UMCT3154	UMPU3550	1	112
SB400	SCB.10	80	47	TE110	TE.6/D	50	25	VL103	CO/5	50	151
SB400GR	SCB.10/GR	80	47	TE210	TE.16/D	30	26	VP101	VPC/PT	25	56
SB401	SCB.10/PT	25	47	TE310	TE.50/D	15	26	VP101	VPC/PT	25	56
SB410	SCB.10/DD	80	47	TE400	TED.4	65	25	VP102	VPC/VT	25	56
SB410GR	SCB.10/DD/GR	80	47	TE500	TE.10/D	35	25	VP201	VPC/PT(EX)I	25	56
SB420	SCB.10/CD	80	47	TH03	TH/3	50	143	VP300	VPC.2	120	56
SB420GR	SCB.10/CD/GR	80	47	TH02	TH/2	50	143	VP300GR	VPC.2/GR	120	56
SC103	SCX/PO/2	40	151	TL100	TLS.2	200	32	VP303	VPC/PTF	25	56
				TL100GR	TLS.2/GR	200	32	VP310	VPC.2 (EX)I	120	56

Index by Catalogue number

CAT. NO.	TYPE	QTY. per pk.	PAGE
VP500GR	VPD.2/GR	40	57
VP501	VPD/PT	25	57
VP560	VPD.2 (EX)	40	57
VP561	VPD/PT(EX)	25	57
VP902	VPC/F02	10	56-57-87
VP903	VPC/F03	10	56-57-87
VP904	VPC/F04	10	56-57-87
VP905	VPC/F05	10	56-57-87
VP906	VPC/F06	10	56-57-87
VP907	VPC/F07	10	56-57-87
VP908	VPC/F08	10	56-57-87
VP909	VPC/F09	10	56-57-87
VP910	VPC/F10	10	56-57-87
VP911	VPC/F11	10	56-57-87
VP912	VPC/F12	10	56-57-87
VP913	VPC/F13	10	56-57-87
VP914	VPC/F14	10	56-57-87
VP915	VPC/F15	10	56-57-87
VP916	VPC/F16	10	56-57-87

W

WP30002	WP5-14	500	113
WP30005	WP75-14	500	113
WP30009	WP1-14	500	113
WP30013	WP15-14	500	113
WP30016	WP25-14	500	113
WP30019	WP40-16	500	113
WP30022	WP60-20	100	113
WP30024	WP100-21	100	113
WP30026	WP160-22	100	113
WP30028	WP250-29	50	113
WP30030	WP350-30	50	113
WP30032	WP500-40	50	113
WP90001	WPD05/15	500	113
WP90002	WPD75/15	500	113
WP90003	WPD01/15	500	113
WP90004	WPD15/16	500	113
WP90005	WPD25/18	250	113
WP90006	WPD04/23	100	113

Z

Z121017	ACI121017	25	121
Z121019	ACI121019	25	121
Z121026	ACI121026	100	126
Z121116	ACI121116	10	123
Z121118	ACI121118	50	126
Z121119	ACI121119	100	126
Z121121	ACI121121	100	126
Z121123	ACI121123	1	126
Z121211	ACI121211	25	126
Z121212	ACI121212	25	126
Z121213	ACI121213	20	125
Z121214	ACI121214	20	125
Z121215	ACI121215	20	125
Z121216	ACI121216	10	125
Z121217	ACI121217	10	125
Z121218	ACI121218	10	125
Z121219	ACI121219	10	125
Z121221	ACI121221	50	126

CAT. NO.	TYPE	QTY. per pk.	PAGE
Z121228	ACI121228	20	123
Z121301	ACI121301	10	123
Z121307	ACI121307	50	126
Z121311	ACI121311	20	123
Z121314	ACI121314	20	123
Z121316	ACI121316	20	124
Z121317	ACI121317	10	124
Z121318	ACI121318	10	124
Z121319	ACI121319	10	124
Z121410	ACI121410	10	124
Z121415	ACI121415	20	123
Z121421	ACI121421	100	126

KLINKMANN

www.klinkmann.com

HELSINKI

tel. +358 9 540 4940
info@klinkmann.fi

ST. PETERSBURG

tel. +7 812 327 3752
klinkmann@klinkmann.spb.ru

MOSCOW

tel. +7 495 641 1616
moscow@klinkmann.spb.ru

YEKATERINBURG

tel. +7 343 287 19 19
yekaterinburg@klinkmann.spb.ru

SAMARA

tel. +7 846 273 95 85
samara@klinkmann.spb.ru

UFA

tel. +7 347 293 70 04
klinkmann@klinkmann.ru

KIEV

tel. +38 044 495 33 40
klinkmann@klinkmann.kiev.ua

KAZAKHSTAN

tel. +77779994825
sales@klinkmann.kz

MINSK

tel. +375 17 200 0876
minsk@klinkmann.com

RIGA

tel. +371 6738 1617
klinkmann@klinkmann.lv

VILNIUS

tel. +370 5 215 1646
post@klinkmann.lt

TALLINN

tel. +372 668 4500
klinkmann.est@klinkmann.ee