

Main catalog

SNA series Terminal blocks

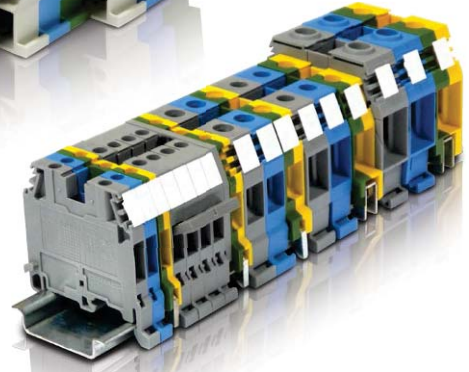

SNA series

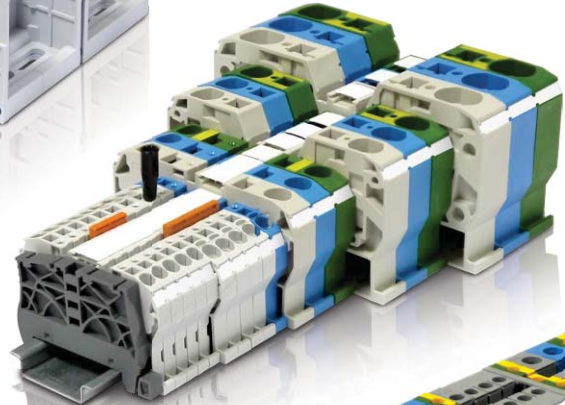
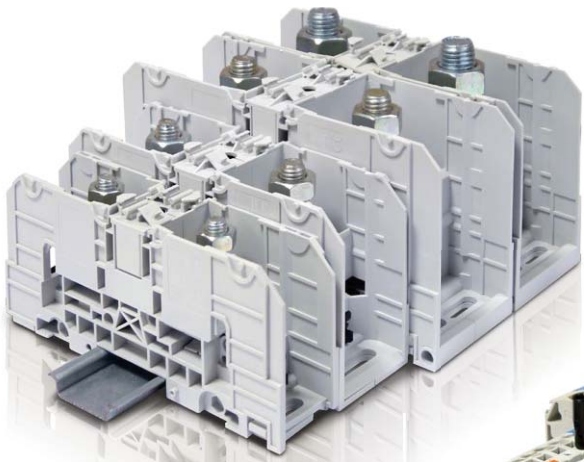







Terminal blocks

Ranges and technologies presentations	2	1
Screw clamp terminal blocks	11	2
Spring clamp terminal blocks	91	3
Stud terminal blocks	135	4
Index	148	5
Marketing material	152	6

Connection devices offering

1

ABB proposes one of the largest connection offering on the market with various technologies: screw, PI-Spring, spring, IDC, pluggable, stud, etc. technologies found in over 8000 products & solutions.

	SNA series		SNK series		Terminal blocks
Purpose	Standard industrial applications		Preferred terminal blocks for: <ul style="list-style-type: none"> – Standard and High standard industries – Building industry – Channel partners 		Preferred terminal blocks and exclusive technologies for dedicated applications and markets (energy, railway, process automation, petro-chemical, etc.)
					
Product families & functions	Screw	Feed-through Multi-deck Ground Disconnect For fuses	Screw	Feed-through Multi-deck Ground Disconnect For fuses Test & measurement Marshalling	Technologies Screw clamp Spring clamp ADO System® Pluggable Safety (spring loaded) Ring lug Stud Quick-connect Functions Protection: PEN, neutral switch Disconnect: multilevel, plugs, etc. For fuse protection Test & Measurement Sensor actuator For distribution boxes Space saving: miniblocks Power distribution Component holders
	Spring	Feed-through Double deck Ground Disconnect For fuses	PI-Spring	Feed-through Double deck Ground Disconnect For fuses	
	Stud	Feed-through	Pluggable PI-Spring	Feed-through 1 or 2 circuits	
Main catalogs	SNA series, terminal blocks		SNK series, terminal blocks		Solution series, terminal blocks
Interactive catalogs: Flash QR code	 		 		 

Web



www.abb.com/lowvoltage
catalogs, brochures, technical
datasheets, certificates, approvals



PI-Spring
terminal blocks
www.abb.com/connecttocontrol
catalogs, videos, presentations,
drawings, tools

Solution series

ESSAILEC®	Interfast	Marking
<p>Test blocks for safe and reliable testing on CT and VT (current and voltage transformers) secondary circuits</p>	<p>PLC pre-wiring system for fast, flexible, reliable connection of PLC's in process automation applications</p>	<p>Markers & marking systems for all identification requirements in electrical panels</p>
		
<p>Current sockets & plugs Voltage sockets & plugs Polarity sockets & plugs Trip sockets & plugs Multicircuits sockets & plugs Coding accessories Protection covers Etc.</p>	<p>Interfast PCB: Compact & standard modules Interfast MS: Modular system based on terminal block technology Functions: <ul style="list-style-type: none"> - 1 to 4 wire connections (sensors) - Disconnect - Fuse - Signal indication - Relays - Optocouplers - Solenoid valve control - Galvanic isolation (2.5 kV) </p>	<p>Terminal block identification and group markers Wire and cable identification Component and equipment identification Panel identification Pre-printed markers for terminal blocks</p>
<p>ESSAILEC®, test blocks</p>  	<p>Interface modules & selection guides</p>   <p>www.web-edia.com/interfast</p>	<p>Marking solutions</p>  



<http://abb-control-products.partcommunity.com>
3D & 2D drawings download

SNA series, terminal blocks

Screw clamp technology

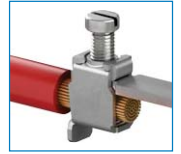

Rely on our expertise

ABB screw clamp technology benefits from 50 years of experience. Billions of our screw clamps have been manufactured and are used worldwide every day in all kinds of applications.

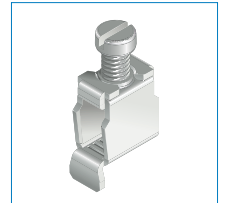

Qualified for worldwide markets and applications
Eco-designed according to international environmental standards in sustainable development.



The proven reliability to support your daily connection challenges

Manufactured since decades

Robust design & high quality standards (UL94-V0, RoHS). Many functions available for a very **wide scope** of industrial applications.

Facilitate your rail assembly process

10 pre-assembled blocks for **quick plug-in mounting**. Asymmetrical shape: easy to handle, **prevents risk of short-circuit**.

Conductor insertion is very easy: the conductor entry is **angled to guide the conductor** into the clamp.

A flap under the clamp avoids conductor to be pushed underneath the clamp.

Universal: **mounting on TH 35 and G rails**.

Quick and efficient marking solutions

Markers come by strips of 10.

Central and lateral marking allow a clear visualisation from any angle.



10 pre-assembled blocks

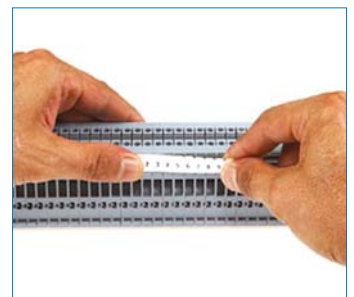

Quick labelling thanks to strips

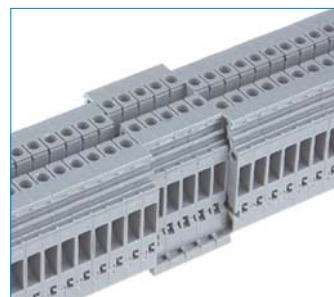

100% safe-visible backwards mounting

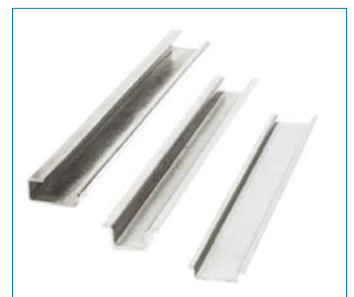

Multi rail mounting

ABB screw clamp technology

The heavy duty connection

Unique design, flies over time thanks to its reliability and safety

The ABB screw clamp technology is designed to avoid accidental releases due to vibrations, shocks or even abusive cable draw. Our exclusive design minimizes the needs of retightening campaigns.

High density capacity

The screw clamp technology can fit up to two conductors per clamp which offers extended possibilities in electrical cabinets.

1

Features

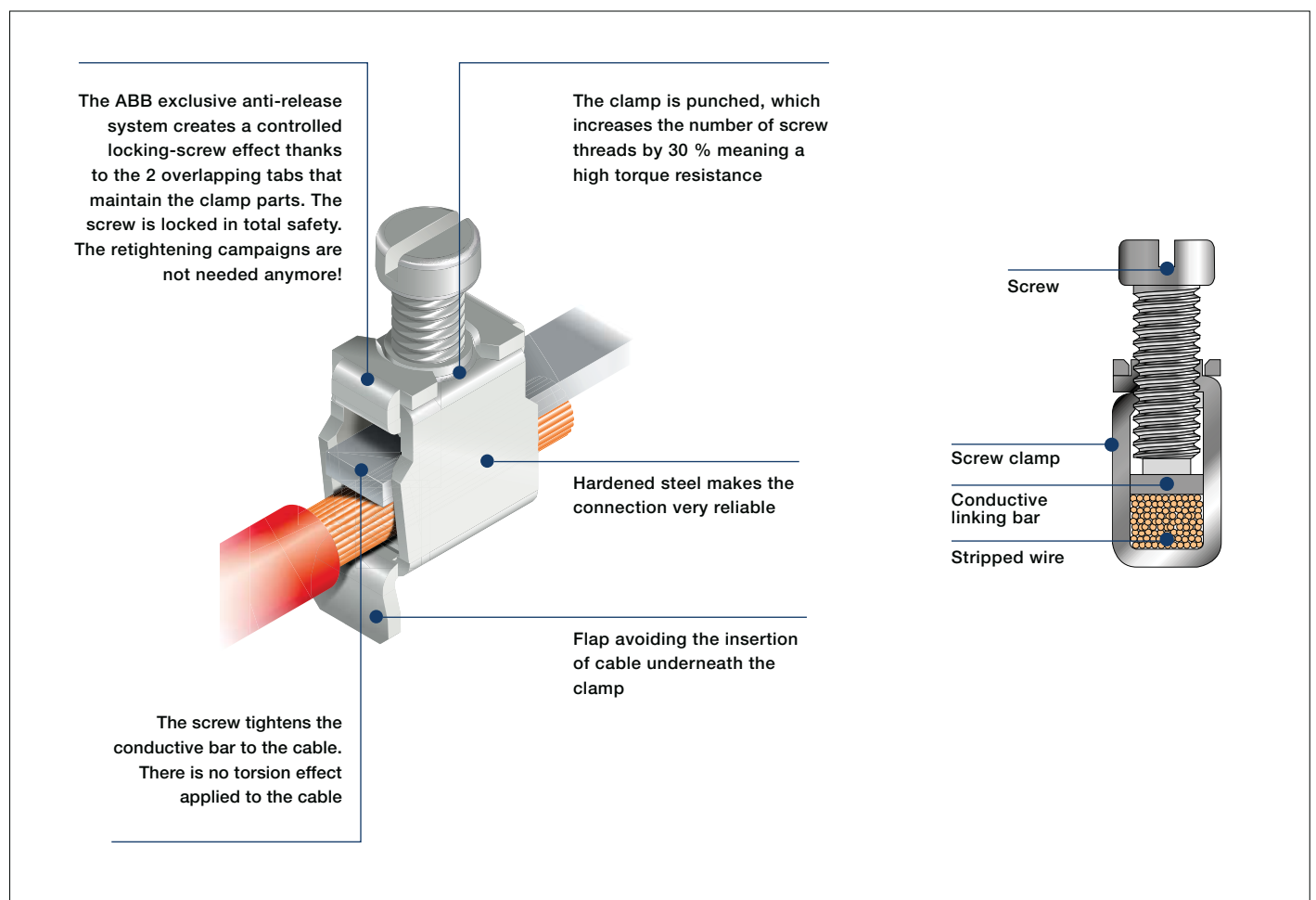

From 0.22 mm² up to 240 mm²
From 24 AWG up to 500 Kcmil

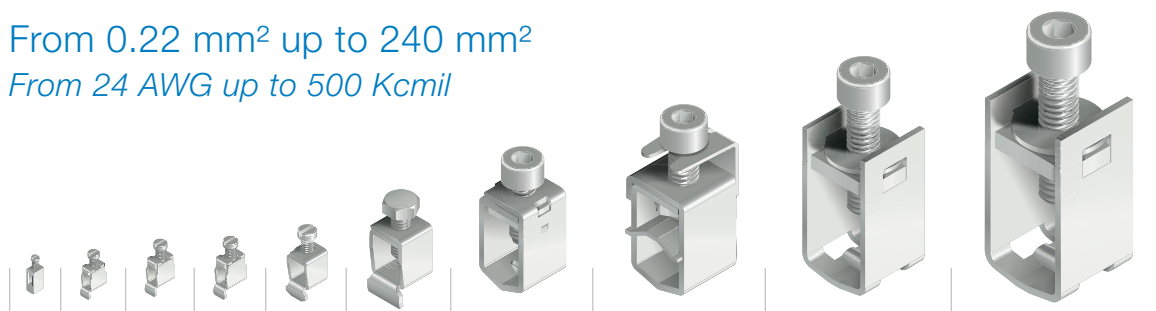

1SNC16117S0201

SNA series, terminal blocks

Spring clamp technology

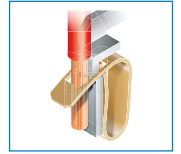

1



ABB has been manufacturing spring clamp terminal blocks since more than 15 years and owns several patents. Our clamp designs benefit from our strong expertise in finite element simulations as well as in-situ testing capabilities.



Qualified for worldwide markets and applications
Eco-designed according to international environmental standards in sustainable development.



The ergonomic front entry connection

Functionality through ergonomic design

Alignment of terminal blocks, markers and jumpers.

Double jumpering system on the whole range.

High quality standards (UL94-V0, RoHS..).

Many functions available for a very **wide scope** of industrial applications.

Facilitate your rail assembly process

10 pre-assembled blocks for **quick plug-in mounting**.

Wire insertion is very easy:

- Front entry connection facilitates wire insertion
- Hands free! **Screwdriver is locked in the clamp** during connection process.

Quick and efficient marking solutions

Markers come by strips of 10.

Central and lateral marking allow a clear visualisation from any angle.



10 pre-assembled blocks



Quick labelling thanks to strips



Alignment

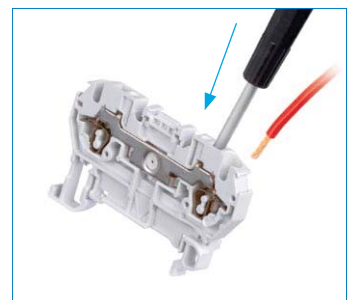

Screwdriver locking

1SNC16211S0201

ABB spring clamp technology

Experience the flexible connection

The ABB spring clamp technology combines all the features appreciated from electrical users by combining flexibility of use with front entry, a good vibration withstand, clamping pressure non dependent on the operator and automatic creeping compensation suppressing the needs of retightening campaigns.

Features

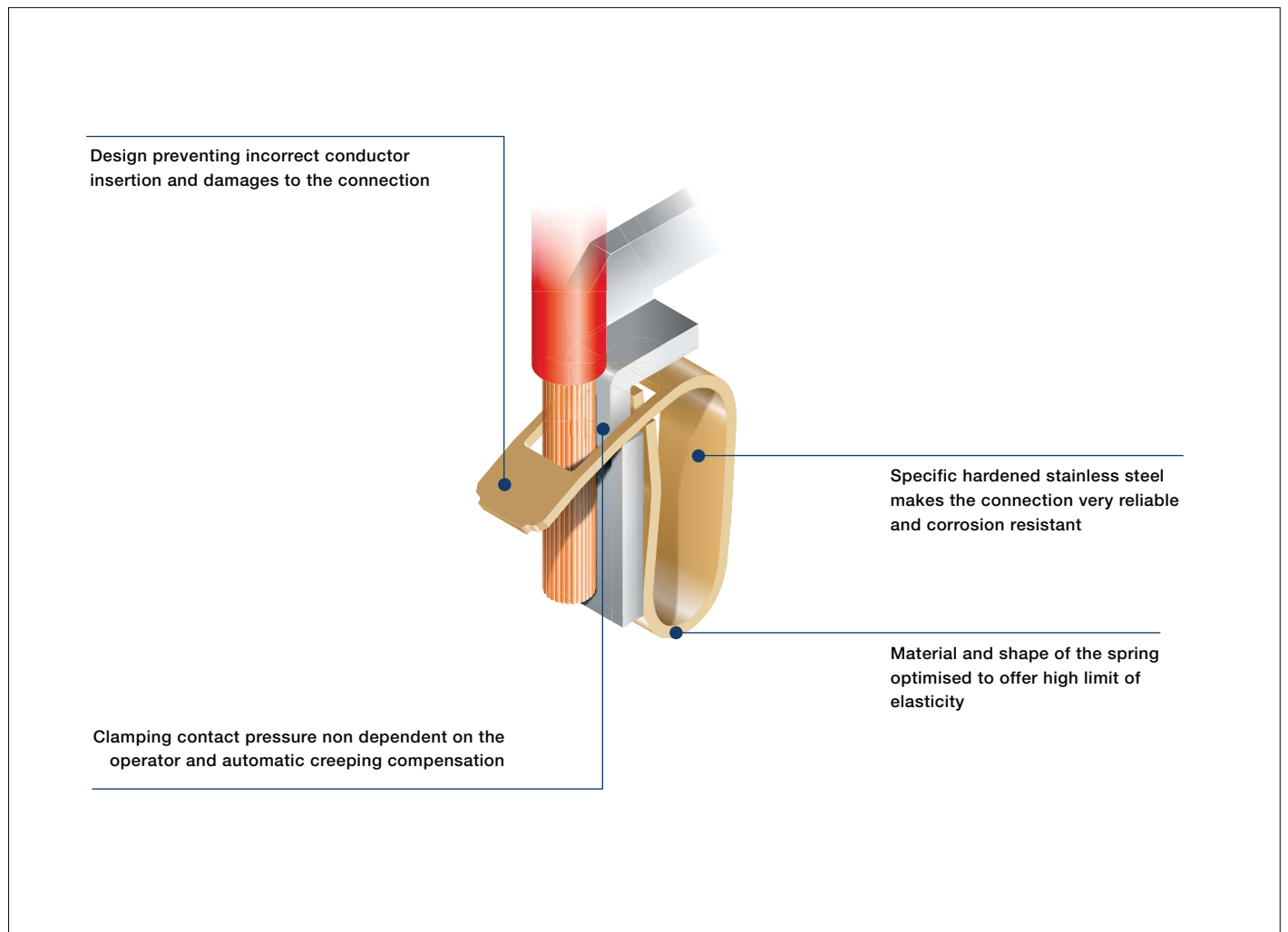

From 0.12 mm² up to 35 mm²
From 26 AWG up to 2 AWG

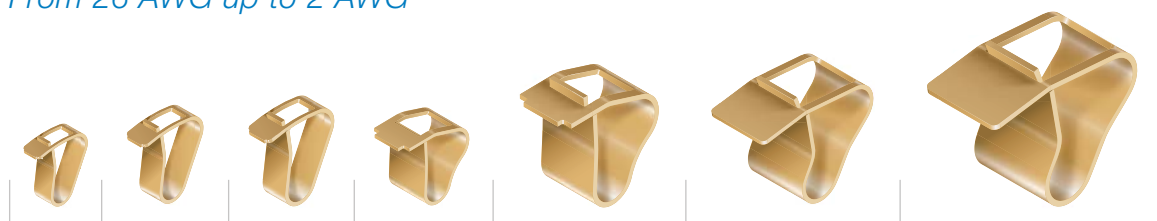

SNA series, terminal blocks

Stud technology



1



ABB proposes a large scope of power terminal blocks dedicated to the connection and distribution of power into electrical installations. Power terminal blocks features standard stud-stud connections as well as hybrid terminals (stud-screw clamp).



Qualified for worldwide markets and applications
Eco-designed according to international environmental standards in sustainable development.

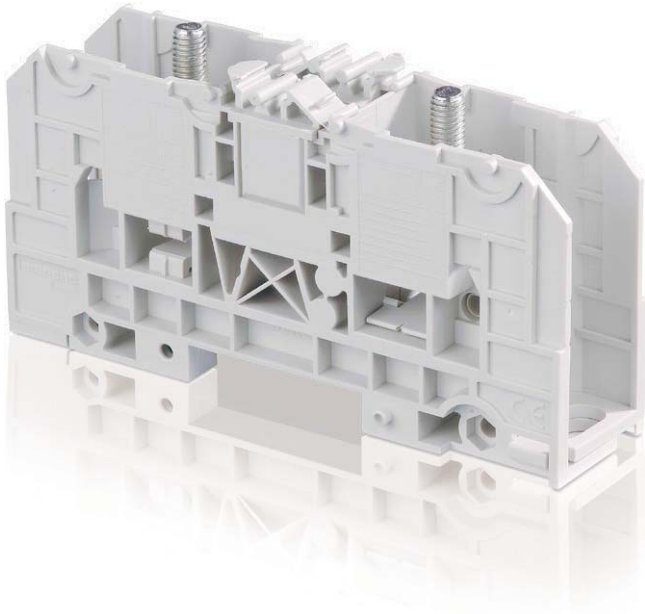

The power distribution terminal blocks

Functionality through ergonomic design

Removable protective covers are designed to increase the **safety of cabinets**, ease the wiring process thanks to its rotative feature.

A **central movable protection** gives access to the jumpering location, and ensures the IP20 isolation.

High quality standards (UL94-V0, RoHS...).

Facilitate your rail assembly process

Various mounting options:

- **Plate mounting** thanks to 2 holes
- **Rail mounting** with bistable foot.

Terminal blocks can be **tight together** thanks to the usage of a threaded stud and nuts.

Pins allow terminal blocks to be **snapped together** for better stability during the tightening process.

Efficient marking

Many marking options: on the center or on the covers with standard markers or adhesive labels.



Rotating protective covers

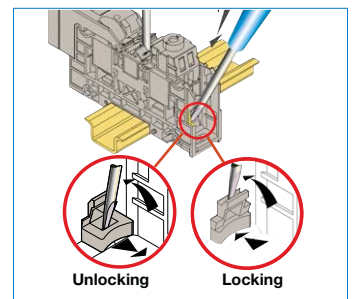

Bistable mounting foot

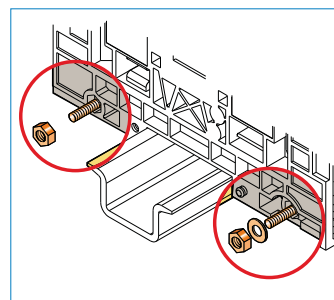

Assembly with stud & snap on pins

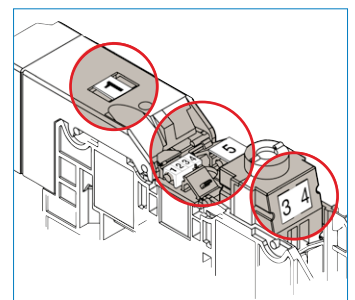

Marking options

1SNC165001S0201

ABB stud & screw clamp technology

The preferred connection for power

Reliability first

The ABB stud and screw clamp are designed to ensure the reliability of connection, and are particularly adapted to high currents requirements. The ABB connection technology includes vibration resistant washers combined with highly resistant steel parts to obtain heavy duty usage.

Features

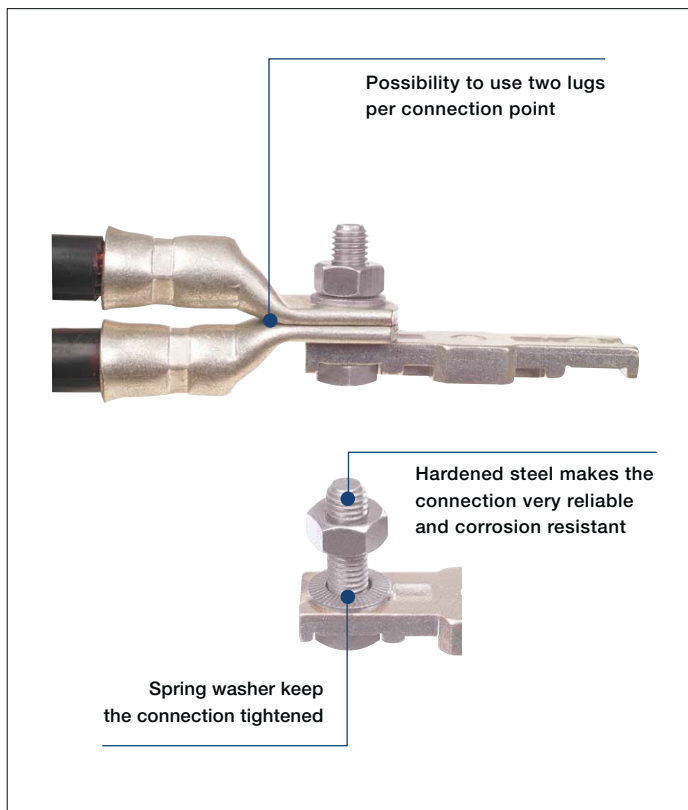

Stud



Screw clamp



Up to 300 mm² / 1000 Kcmil

				
M6 35 mm ² 1 AWG	M8 70 mm ² 000 AWG	M10 120 mm ² 300 Kcmil	M12 185 mm ² 500 Kcmil	M16 300 mm ² 1000 Kcmil

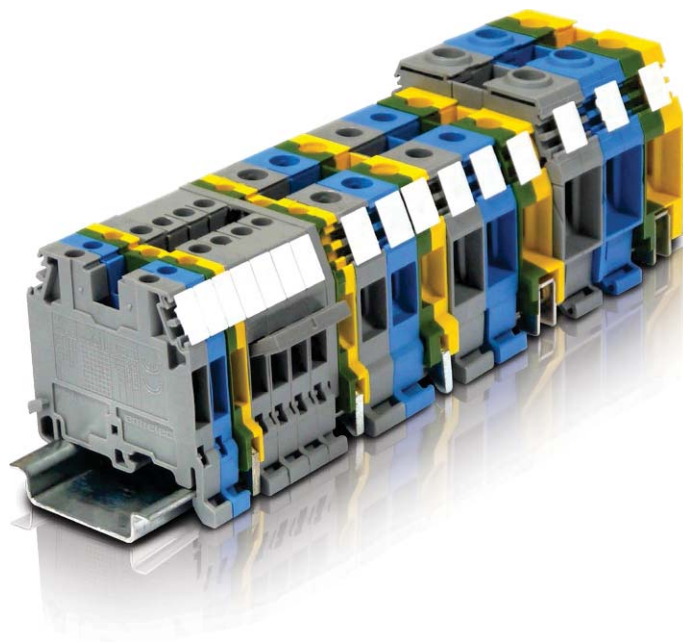

SNA series, terminal blocks

Screw clamp technology

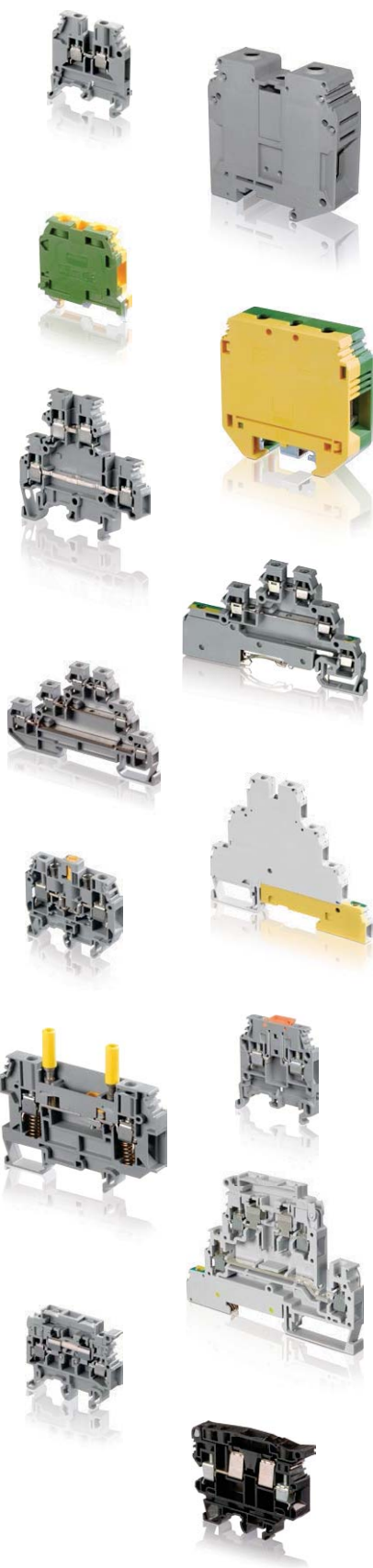

Overview

Feed-through

2.5 mm ² / 12 AWG	MA2.5/5		14
4 mm ² / 10 AWG	M4/6		16
	M4/6.3A & M4/6.4A	3 & 4 connections	18
6 mm ² / 8 AWG	M6/8		20
10 mm ² / 6 AWG	M10/10		22
16 mm ² / 6 AWG	M16/12		24
35 mm ² / 0 AWG	M35/16		25
70 mm ² / 00 AWG	D70/22		26
95 mm ² / 0000 AWG	D95/26		27
150 mm ²	D150/31.D10		28
240 mm ²	D240/36.D10		29

Ground

2.5 mm ² / 12 AWG	MA2.5/5.P & D2.5/5.P		30
4 mm ² / 12 AWG	M4/6.P & D4/6.P		32
	M4/6.3A.P & M4/6.4A.P	3 & 4 connections	34
6 mm ² / 8 AWG	M6/8.P & D6/8.P		36
10 mm ² / 6 AWG	M10/10.P		38
16 mm ² / 4 AWG	M16/12.P		39
35 mm ² / 0 AWG	M35/16.P		40
70 mm ² / 00 AWG	D70/22.P		41
95 mm ² / 0000 AWG	D95/26.P		42

Double deck

2.5 mm ² / 12 AWG	MA2.5/5.D2		44
4 mm ² / 12 AWG	M4/6.D2		46
	M4/6.D1	One circuit	48
6 mm ² / 8 AWG	M6/8.D2		50
2.5 mm ² / 12 AWG	D2.5/5.DP	Double deck + ground	52

Triple deck

2.5 mm ² / 12 AWG	D2.5/6.DA		53
4 mm ² / 12 AWG	D4/6.T		54
	D4/6.P.T1	7 connections for grounding	56

Disconnect

2.5 mm ² / 12 AWG	MA2.5/5.SNB		58
4 mm ² / 10 AWG	M4/6.SNB		60
6 mm ² / 8 AWG	M6/8.SNB		62
4 mm ² / 12 AWG	M4/6.D2.SNBT	Double deck, disconnect	63
4 mm ² / 10 AWG	M4/6.SB & M6/8.SB	Disconnect with plug	64
4 mm ²	M4/6.D2.SB	Double deck, disconnect with plug	66
6 mm ² / 8 AWG	M6/8.STP	Disconnect with push-turn knob	67
	M6/8.STP3	Feed-through - profile aligned with M6/8.STP	69
	M6/8.ST	Test disconnect with screwdriver sliding link	70
	M6/8.ST7	Feed-through - profile aligned with M6/8.ST	75

For 5x20 and 5x25 mm fuses (0.197x0.787 in and 0.197x0.984 in)

4 mm ² / 12 AWG	M4/8.SF	Fuse holders	76
	M4/8.SN	Disconnect - profile aligned with M4/8.SF	80
	M4/8	Feed-through - profile aligned with M4/8.SF	81
	M4/8.D2.SF	Double deck, fuse holder	82
	D4/8.D2.P.SF	Double deck, fuse holder, ground	84

For 6.3x25 and 6.3x32 mm fuses (¼ x 1 in and ¼ x 1¼ in)

10 mm ² / 10 AWG	ML10/13.SF		86
	ML10/13.SN	Disconnect - profile aligned with ML10/13.SF	88

SNA series, terminal blocks

Screw clamp technology

2



Feed-through



Screw rail connection



Screwless rail connection



Double deck

Section									
IEC	UL/CSA								
2.5 mm ²	12 AWG	MA2.5/5	5 mm 0.197 in	MA2.5/5.P	5 mm 0.197 in	D2.5/5.P	5 mm 0.197 in	MA2.5/5.D2	5 mm 0.197 in
4 mm ²	10-12 AWG	M4/6	6 mm 0.236 in	M4/6.P	6 mm 0.236 in	D4/6.P	6 mm 0.236 in	M4/6.D2	6 mm 0.236 in
6 mm ²	8 AWG	M6/8	8 mm 0.315 in	M6/8.P	8 mm 0.315 in	D6/8.P	8 mm 0.315 in	M6/8.D	8 mm 0.315 in
10 mm ²	6-10 AWG	M10/10	10 mm 0.394 in	M10/10.P	10 mm 0.394 in				
16 mm ²	4-6 AWG	M16/12	12 mm 0.472 in	M16/12.P	12 mm 0.472 in				
35 mm ²	0-2 AWG	M35/16	16 mm 0.630 in	M35/16.P	16 mm 0.630 in				
70 mm ²	00 AWG	D70/22	22 mm 0.866 in	D70/22.P	22 mm 0.866 in				
95 mm ²	0000 AWG	D95/26	26 mm 1.024 in	D95/26.P	26 mm 1.024 in				
150 mm ²		D150/31.D10	31 mm 1.220 in						
240 mm ²		D240/36.D10	36 mm 1.417 in						



Disconnect with blade



Disconnect with plug



Section									
IEC	UL/CSA								
2.5 mm ²	12 AWG	MA2.5/5.SNB..	5 mm 0.197 in	M4/6.D2.SNBT	6 mm 0.236 in	M4/6.SB	6 mm 0.236 in	M4/6.D2.SB	6 mm 0.236 in
4 mm ²	10-12 AWG	M4/6.SNB..	6 mm 0.236 in						
6 mm ²	8 AWG	M6/8.SNB	8 mm 0.315 in			M6/8.SB	8 mm 0.315 in		



For 5 x 20 mm and 5 x 25 mm fuses (0.197" x 0.787" and 0.197" x 0.984")

Section							
IEC	UL/CSA						
4 mm ²	10-12 AWG	M4/8.SF	8 mm 0.315 in	M4/8.SN	8 mm 0.315 in	M4/8	8 mm 0.315 in
10 mm ²	10 AWG						

- Terminal - Hole for testing or jumpering - Testing point - Fuse holder - Blown-fuse indicator - Ground connection, linked to the DIN rail
- Interconnection between decks - Disconnect function - Quarter turn disconnect function - Sliding link disconnect function

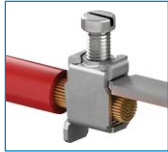

Double deck + ground



Triple deck



Triple deck + ground



D2.5/6.DP	5 mm 0.197 in	D2.5/6.DA	5 mm 0.197 in	D4/6.T3.P	6 mm 0.236 in	D4/6.PT1	6 mm 0.236 in
		D4/6.T	6 mm 0.236 in				



Disconnect with push-turn knob



Test disconnect



M6/8.STP	8 mm 0.315 in	M6/8.STP3	8 mm 0.315 in	M6/8.ST	8 mm 0.315 in	M6/8.ST7	8 mm 0.315 in
-----------------	---------------	------------------	---------------	----------------	---------------	-----------------	---------------



Double deck - For 5 x 20 mm and 5 x 25 mm fuses (0.197" x 0.787" and 0.197" x 0.984")

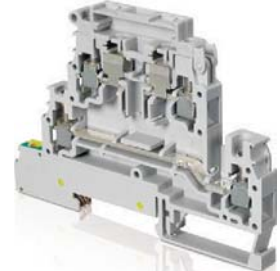

For 6.3 x 25 and 6.3 x 32 mm fuses (1/4" x 1" and 1/4" x 1 1/4")



M4/8.D2.SF	8 mm 0.315 in	D4/8.D2.P.SF	8 mm 0.315 in	ML10/13.SF	13 mm 0.512 in	ML10/13.SN	13 mm 0.512 in
-------------------	---------------	---------------------	---------------	-------------------	----------------	-------------------	----------------

All the technical data for UL/CSA standard and dimensions in inches are in italic.

MA2.5/5 screw clamp terminal blocks

Feed-through - 5 mm 0.197 in spacing



2.5 mm²
12 AWG

Description

- Flexibility: snap onto symmetrical and asymmetrical rails,
- Many colors are available in addition to our generic grey, to help you quickly identify any of specific functions.

Ordering details

Description	Color	Type	Order code	Pkg qty	Weight (1 pce) g
Feed-through	Grey	MA2.5/5	1SNA115486R0300	50	6.61
	Blue	MA2.5/5.N	1SNA125486R0500	50	6.61
	Orange	MA2.5/5	1SNA105075R2000	50	6.61
	Yellow	MA2.5/5	1SNA105486R1200	50	6.61
	Red	MA2.5/5	1SNA400184R2700	50	6.61
	White	MA2.5/5	1SNA105052R2100	50	6.61
	Black	MA2.5/5	1SNA105077R2200	50	6.61
	Beige	MA2.5/5	1SNA195486R0400	50	6.61

Main technical data

Connecting capacity		IEC	UL	CSA	Rail	G32, TH 35-7.5, TH 35-15
1 conductor per clamp	Rigid - Solid / Stranded	0.2-4 mm ²	22-12 AWG	22-12 AWG	Wire stripping length	10 mm 0.39 in
	Flexible	0.22-2.5 mm ²				
	with insulated ferrule					
	Gauge	A3			Tool	Flat screwdriver Ø 3.5 mm Ø 0.137 in
Rated current / Rated cross section		24 A / 2.5 mm ²	30 A / 12 AWG	25 A / 12 AWG	Torque	0.4 - 0.6 N.m 3.5 - 5.3 lb.in
Rated short-time withstand current (1s)		300 A				
Rated voltage		1000 V	600 V	600 V		
Impulse withstand voltage		8000 V				
Protection		IP20	NEMA 1			

The connecting capacity data for one Rigid - Solid / Stranded - Flexible conductor (when applicable) is a mandatory information required by IEC, UL and CSA standards. All other data are provided as supplementary information only. For more details, please consult our CB, UL or CSA certificates and technical datasheet available on <http://www.abb.com>

CE	RoHS	UL	CSA	CCC	GS
CE	RoHS	UL	CSA	CCC	GS



MA2.5/5

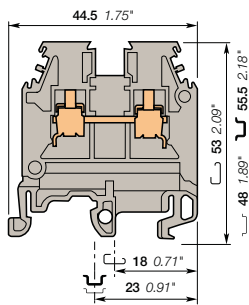

5 mm 0.197 in spacing

Accessories

Description	Color	Type	Order code	Pkg qty	Weight (1 pce) g	
1 End stops	Grey	BAM2	1SNA206351R1600	50	12.00	
		BADL	1SNA399903R0200	50	4.70	
2 End sections	Grey	FEM6	1SNA118368R1600	20	2.40	
3 Jumper bars	Grey	2 poles	BJMI5-2	1SNA176278R1600	10	3.30
		3 poles	BJMI5-3	1SNA176279R1700	10	5.00
		4 poles	BJMI5-4	1SNA176280R0500	10	6.70
		5 poles	BJMI5-5	1SNA176281R2200	10	8.40
		10 poles	BJMI5-10	1SNA176282R2300	10	16.90
		30 A	PC5-2	1SNA113542R1000	10	1.80
4 Lateral jumper bars	Grey	PC5-10	1SNA113544R1200	10	6.00	
5 Cross spacing jumpers		EL6	1SNA173627R2100	10	0.10	
6 Insulating tips		EIP	1SNA113550R2400	10		
7 Circuit separators	Grey	3 mm	SCFM6	1SNA114825R0500	20	4.00
		0 mm	SCMA5	1SNA116728R2500	10	
		3 mm	SCFCV1-2	1SNA116795R1100	10	8.00
			SCF6	1SNA118707R0300	20	
8 Shield connectors		CBM5	1SNA178745R1400	50		
9 Protecting covers	Transparent	Length 1 m 39 in	CPV1-2	1SNA176816R1200	1	
		Length 500 mm 19.70 in	CPM	1SNA187312R1400	1	
10 Terminal block markers	White	RC510	1SNA231000R0700	1	5.20	

Complete list of accessories is indicated in the terminal block datasheet. Some accessories such as jumper bars may modify the terminal block's ratings: complete information in the accessories catalogue pages.

Ground screw clamp terminal blocks

Description	Color	Type	Order code	Pkg qty	Weight (1 pce) g
Ground	Green-yellow	MA2.5/5.P	1SNA165488R2700	50	18.00

All the technical data for UL/CSA standard and dimensions in inches are in italic. Technical data valid for copper conductors only.

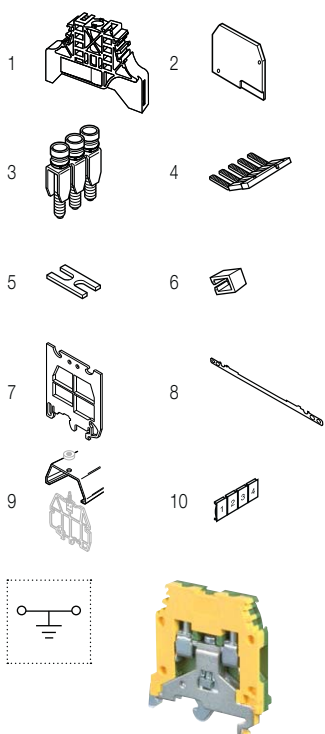

MA2.5/5 screw clamp terminal blocks

Feed-through - 5 mm 0.197 in spacing



2.5 mm²
12 AWG

With partition

Ordering details

Description	Color	Type	Order code	Pkg qty	Weight (1 pce) g
Feed-through With partition	Grey	MA2.5/5.1	1SNA115485R0200	50	6.61
	Blue	MA2.5/5.1	1SNA125485R0400	50	6.61

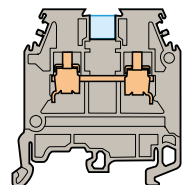

5 mm 0.197 in spacing



Main technical data

	IEC	UL	CSA	Nota
Rated voltage	1000 V	600 V	600 V	
Impulse withstand voltage	8000 V			
Protection	IP20	NEMA 1		

--	--	--	--	--	--	--	--	--	--	--	--	--	--	--	--	--	--	--	--

Accessories

Description	Color	Type	Order code	Pkg qty	Weight (1 pce) g
1 Test sockets DIA 2 mm 0.079 in		AL2	1SNA163046R2400	50	0.90
2 Test plugs DIA 2 mm 0.079 in	Black	FC2	1SNA007865R2600	100	

All the technical data for UL/CSA standard and dimensions in inches are in italic.
Technical data valid for copper conductors only.

M4/6 screw clamp terminal blocks

Feed-through - 6 mm 0.236 in spacing



2



M4/6

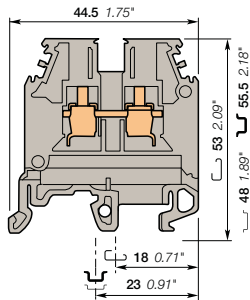

6 mm 0.236 in spacing

Description

- Flexibility: snap onto symmetrical and asymmetrical rails,
- Many colors are available in addition to our generic grey, to help you quickly identify any of specific functions.

Ordering details

Description	Color	Type	Order code	Pkg qty	Weight (1 pce) g
Feed-through	Grey	M4/6	1SNA115116R0700	50	8.20
	Blue	M4/6.N	1SNA125116R0100	50	8.20
	Orange	M4/6	1SNA105002R2000	50	8.20
	Yellow	M4/6	1SNA105116R1600	50	8.20
	Green	M4/6	1SNA105001R2700	50	8.20
	Red	M4/6	1SNA105032R1500	50	8.20
	Purple	M4/6	1SNA206404R0500	50	8.20
	Brown	M4/6	1SNA105209R1400	50	8.20
	White	M4/6	1SNA105051R2000	50	8.20
	Black	M4/6	1SNA105031R1400	50	8.20
	Beige	M4/6	1SNA195116R0000	50	8.20

Main technical data

Connecting capacity		IEC	UL	CSA	Mounting instructions	
1 conductor per clamp	Rigid - Solid / Stranded	0.2-4 mm ²	22-10 AWG	24-10 AWG	Rail	G32, TH 35-7.5, TH 35-15
	Flexible with insulated ferrule	0.22-4 mm ²			Wire stripping length	9.5 mm 0.37 in
	Gauge	A4			Tool	Flat screwdriver Ø 4 mm Ø 0.157 in
Rated current / Rated cross section		32 A / 4 mm ²	30 A / 10 AWG	30 A / 10 AWG	Torque	0.5 - 0.8 N.m 4.4 - 7.1 lb.in
Rated short-time withstand current (1s)		480 A				
Rated voltage		1000 V	600 V	600 V		
Impulse withstand voltage		8000 V				
Protection		IP20	NEMA 1			

The connecting capacity data for one Rigid - Solid / Stranded - Flexible conductor (when applicable) is a mandatory information required by IEC, UL and CSA standards. All other data are provided as supplementary information only. For more details, please consult our CB, UL or CSA certificates and technical datasheet available on <http://www.abb.com>

CE	RoHS	RoHS	USR	CSA	Gost R
----	------	------	-----	-----	--------

Accessories

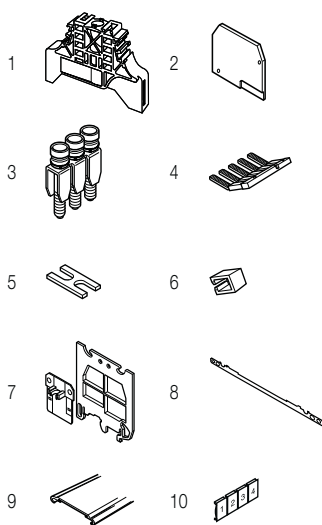

Description	Color	Type	Order code	Pkg qty	Weight (1 pce) g	
1 End stops	Grey	BAM2	1SNA206351R1600	50	12.00	
		BADL	1SNA399903R0200	50	4.70	
2 End sections	Grey	FEM6	1SNA118368R1600	20	2.40	
3 Jumper bars	Grey	2 poles	BJMI6-2	1SNA176663R0000	10	4.40
		3 poles	BJMI6-3	1SNA176664R0100	10	6.70
		4 poles	BJMI6-4	1SNA176665R0200	10	8.90
		5 poles	BJMI6-5	1SNA176666R0300	10	11.20
		10 poles	BJMI6-10	1SNA176667R0400	10	22.40
4 Lateral jumper bars	Grey	2 poles	PC6-2	1SNA113546R1400	10	2.00
		10 poles	PC6-10	1SNA113548R2600	10	8.00
5 Cross spacing jumpers	Grey	5 mm 0.200 in - 6 mm 0.236 in - 8 mm 0.315 in	EL6	1SNA173627R2100	10	0.10
		Universal screw jumper bar kit N ^{PI}	BJDP1	1SNA179623R0300	10	7.00
		Universal screw jumper bar kit N ^{III}	BJDP3	1SNA179625R0500	10	5.00
6 Insulating tips		For lateral jumper bars type PC...	EIP	1SNA113550R2400	10	
7 Circuit separators	Grey	0 mm	SCM6	1SNA113003R1000	10	0.30
		3 mm	SCF6	1SNA118707R0300	20	
8 Shield connectors			CBM5	1SNA118745R1400	50	
9 Protecting covers	Transparent	Length 500 mm 19.70 in	CPM	1SNA187312R1400	1	
10 Terminal block markers	White	Blank card	RC610	1SNA233000R0100	1	7.50

Complete list of accessories is indicated in the terminal block datasheet. Some accessories such as jumper bars may modify the terminal block's ratings: complete information in the accessories catalogue pages.

Ground screw clamp terminal blocks

Description	Color	Type	Order code	Pkg qty	Weight (1 pce) g
Ground	Green-yellow	M4/6.P	1SNA165113R1600	50	21.00

All the technical data for UL/CSA standard and dimensions in inches are in italic. Technical data valid for copper conductors only.

M4/6 screw clamp terminal blocks

Feed-through - 6 mm 0.236 in spacing

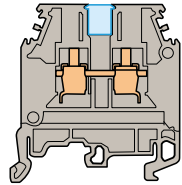

6 mm 0.236 in spacing



With partition

Ordering details

Description	Color	Type	Order code	Pkg qty	Weight (1 pce) g
Feed-through With partition	Grey <input type="checkbox"/>	M4/6.1	1SNA115259R0600	50	8.20
	Orange <input type="checkbox"/>	M4/6.1	1SNA105208R1300	50	8.20

Main technical data	IEC	UL	CSA	Nota
Rated voltage	1000 V	600 V	600 V	
Impulse withstand voltage	8000 V			
Protection	IP20	NEMA 1		

--	--	--	--	--

Accessories

Description	Color	Type	Order code	Pkg qty	Weight (1 pce) g
1 Test sockets		AL2	1SNA163043R2100	50	0.90
		AL3	1SNA163261R0000	50	1.20
		AL4-M3	1SNA206721R0100	50	1.10
2 Test plugs	Black <input checked="" type="checkbox"/>	FC2	1SNA007865R2600	100	

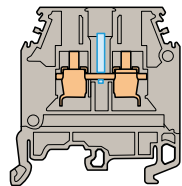
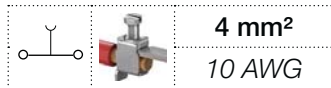

6 mm 0.236 in spacing



With test socket DIA 2 mm 0.079 in

Ordering details

Description	Color	Type	Order code	Pkg qty	Weight (1 pce) g
Feed-through With test socket DIA 2 mm 0.079 in	Grey <input type="checkbox"/>	M4/6.2	1SNA115217R1400	50	8.20

Main technical data	IEC	UL	CSA	Nota
Rated voltage	800 V	600 V	600 V	
Impulse withstand voltage	8000 V			
Protection	IP20	NEMA 1		

--	--	--	--	--

Accessories

Description	Color	Type	Order code	Pkg qty	Weight (1 pce) g
1 Test plugs	Black <input checked="" type="checkbox"/>	FC2	1SNA007865R2600	100	

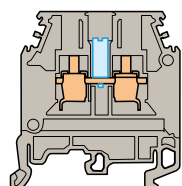

6 mm 0.236 in spacing



With test socket DIA 4 mm 0.157 in

Ordering details

Description	Color	Type	Order code	Pkg qty	Weight (1 pce) g
Feed-through With test socket DIA 4 mm 0.157 in	Grey <input type="checkbox"/>	M4/6.4	1SNA115192R0400	50	8.20
	Beige <input type="checkbox"/>	M4/6.4	1SNA195192R0500	50	8.20

Main technical data	IEC	UL	CSA	Nota
Rated voltage	800 V	600 V	600 V	
Impulse withstand voltage	8000 V			
Protection	IP20	NEMA 1		

--	--	--	--	--

Accessories

Description	Color	Type	Order code	Pkg qty	Weight (1 pce) g
1 Test plugs	White <input type="checkbox"/>	FC4	1SNA167860R0100	10	

All the technical data for UL/CSA standard and dimensions in inches are in italic.
Technical data valid for copper conductors only.

M4/6.3A screw clamp terminal blocks

Feed-through - 6 mm 0.236 in spacing



2



M4/6.3A

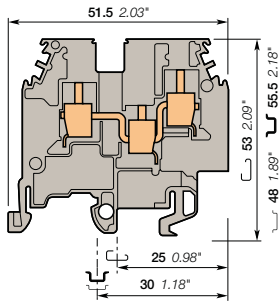

6 mm 0.236 in spacing

Description

- Ease one potential distribution on 3 independent screw clamps,
- Flexibility: snap onto symmetrical and asymmetrical rails.

Ordering details

Description	Color	Type	Order code	Pkg qty	Weight (1 pce) g
Feed-through	Grey <input type="checkbox"/>	M4/6.3A	1SNA115468R2000	50	11.00
	Blue <input type="checkbox"/>	M4/6.3A.N	1SNA125468R2200	50	11.00

Main technical data

Connecting capacity	IEC	UL	CSA	Rail	Wire stripping length	Tool	Torque
1 conductor per clamp	Rigid - Solid / Stranded	0.2-4 mm ²	22-10 AWG	12 AWG	9.5 mm 0.37 in	Flat screwdriver Ø 4 mm Ø 0.157 in	0.5 - 0.8 N.m 4.4 - 7.1 lb.in
	Flexible with insulated ferrule	0.22-4 mm ²					
Gauge	A4						
Rated current / Rated cross section	32 A / 4 mm ²	20 A / 10 AWG	25 A / 12 AWG				
Rated short-time withstand current (1s)	480 A						
Rated voltage	800 V	600 V	600 V				
Impulse withstand voltage	8000 V						
Protection	IP20	NEMA 1					

The connecting capacity data for one Rigid - Solid / Stranded - Flexible conductor (when applicable) is a mandatory information required by IEC, UL and CSA standards. All other data are provided as supplementary information only. For more details, please consult our CB, UL or CSA certificates and technical datasheet available on <http://www.abb.com>

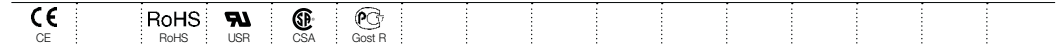

Accessories

Description	Color	Type	Order code	Pkg qty	Weight (1 pce) g	
1 End stops	Grey <input type="checkbox"/>	BAM2	1SNA206351R1600	50	12.00	
		BADL	1SNA39903R0200	50	4.70	
2 End sections	Grey <input type="checkbox"/>	FEM3A	1SNA116576R1500	20	3.30	
3 Jumper bars		2 poles	BJM16-2	1SNA176663R0000	10	4.40
		3 poles	BJM16-3	1SNA176664R0100	10	6.70
		4 poles	BJM16-4	1SNA176665R0200	10	8.90
		5 poles	BJM16-5	1SNA176666R0300	10	11.20
		10 poles	BJM16-10	1SNA176667R0400	10	22.40
4 Lateral jumper bars	Grey <input type="checkbox"/>	2 poles	PC6-2	1SNA113546R1400	10	2.00
		10 poles	PC6-10	1SNA113548R2600	10	8.00
5 Cross spacing jumpers		5 mm 0.200 in - 6 mm 0.236 in - 8 mm 0.315 in	EL6	1SNA173627R2100	10	0.10
		Universal screw jumper bar kit N ^o I	BJDP1	1SNA179623R0300	10	7.00
		Universal screw jumper bar kit N ^o III	BJDP3	1SNA179625R0500	10	5.00
6 Insulating tips		For lateral jumper bars type PC...	EIP	1SNA113550R2400	10	
7 Circuit separators	Grey <input type="checkbox"/>	0 mm 0 in	SCM6	1SNA113003R1000	10	0.30
8 Test sockets		DIA 2 mm 0.079 in	AL2	1SNA163043R2100	50	0.90
		DIA 3 mm 0.120 in	AL3	1SNA163261R0000	50	1.20
9 Terminal block markers	White <input type="checkbox"/>	Blank card	RC610	1SNA233000R0100	1	7.50

Complete list of accessories is indicated in the terminal block datasheet. Some accessories such as jumper bars may modify the terminal block's ratings: complete information in the accessories catalogue pages.

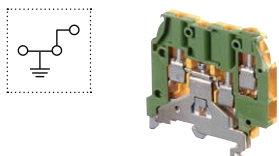
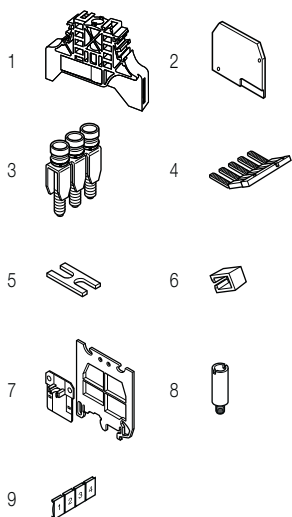

Ground screw clamp terminal blocks

Description	Color	Type	Order code	Pkg qty	Weight (1 pce) g
Ground	Green-yellow <input type="checkbox"/>	M4/6.3A.P	1SNA195637R1200	50	22.00

All the technical data for UL/CSA standard and dimensions in inches are in *italics*. Technical data valid for copper conductors only.

M4/6.4A screw clamp terminal blocks

Feed-through - 6 mm 0.236 in spacing



4 mm²
10 AWG

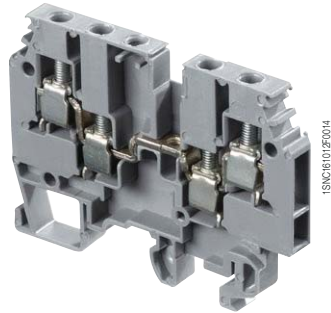

M4/6.4A

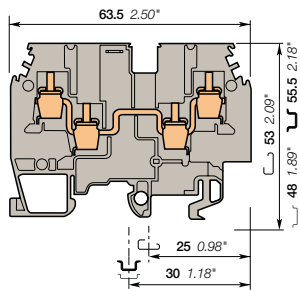

6 mm 0.236 in spacing

Description

- Ease one potential distribution on 4 independent screw clamps,
- Flexibility: snap onto symmetrical and asymmetrical rails.

Ordering details

Description	Color	Type	Order code	Pkg qty	Weight (1 pce) g
Feed-through	Grey	M4/6.4A	1SNA115479R2300	50	20.00
	Blue	M4/6.4A.N	1SNA125479R2500	50	20.00

Main technical data

Connecting capacity		IEC	UL	CSA	Mounting instructions	
1 conductor per clamp	Rigid - Solid / Stranded	0.2-4 mm ²	22-10 AWG	12 AWG	Rail	G32, TH 35-7.5, TH 35-15
	Flexible with insulated ferrule	0.22-4 mm ²			Wire stripping length	9.5 mm 0.37 in
	Gauge	A4			Tool	Flat screwdriver Ø 4 mm Ø 0.157 in
Rated current / Rated cross section		32 A / 4 mm ²	20 A / 10 AWG	25 A / 12 AWG	Torque	0.5 - 0.8 N.m 4.4 - 7.1 lb.in
Rated short-time withstand current (1s)		480 A				
Rated voltage		800 V	600 V	600 V		
Impulse withstand voltage		8000 V				
Protection		IP20	NEMA 1			

The connecting capacity data for one Rigid - Solid / Stranded - Flexible conductor (when applicable) is a mandatory information required by IEC, UL and CSA standards. All other data are provided as supplementary information only. For more details, please consult our CB, UL or CSA certificates and technical datasheet available on <http://www.abb.com>

CE	RoHS	UR	CSA	Gost R
CE	RoHS	UR	CSA	Gost R

Accessories

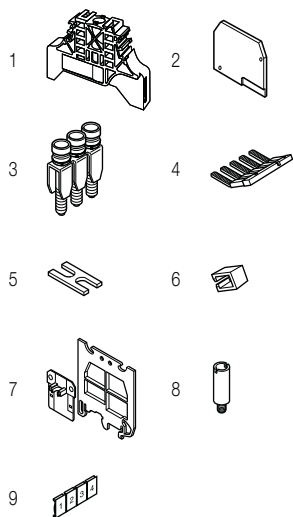

Description	Color	Type	Order code	Pkg qty	Weight (1 pce) g	
1 End stops	Grey	10 mm	BAM2	1SNA206351R1600	50	12.00
		9 mm	BADL	1SNA399903R0200	50	4.70
2 End sections	Grey	3 mm	FEM4A	1SNA116629R2200	20	3.80
3 Jumper bars	Grey	2 poles	BJMI6-2	1SNA176663R0000	10	4.40
		3 poles	BJMI6-3	1SNA176664R0100	10	6.70
		4 poles	BJMI6-4	1SNA176665R0200	10	8.90
		5 poles	BJMI6-5	1SNA176666R0300	10	11.20
		10 poles	BJMI6-10	1SNA176667R0400	10	22.40
4 Lateral jumper bars	Grey	2 poles	PC6-2	1SNA113546R1400	10	2.00
		10 poles	PC6-10	1SNA113548R2600	10	8.00
5 Cross spacing jumpers	Grey	5 mm 0.200 in - 6 mm 0.236 in - 8 mm 0.315 in	EL6	1SNA173627R2100	10	0.10
		Universal screw jumper bar kit N°1	BJDP1	1SNA179623R0300	10	7.00
		Universal screw jumper bar kit N°III	BJDP3	1SNA179625R0500	10	5.00
6 Insulating tips		For lateral jumper bars type PC...	EIP	1SNA113550R2400	10	
7 Circuit separators	Grey	0 mm	SCM6	1SNA113003R1000	10	0.30
8 Test sockets	Grey	DIA 2 mm 0.079 in	AL2	1SNA163043R2100	50	0.90
		DIA 3 mm 0.120 in	AL3	1SNA163261R0000	50	1.20
9 Terminal block markers	White	Blank card	RC610	1SNA233000R0100	1	7.50

Complete list of accessories is indicated in the terminal block datasheet. Some accessories such as jumper bars may modify the terminal block's ratings: complete information in the accessories catalogue pages.

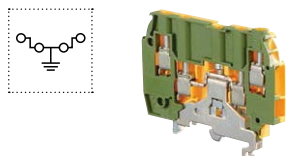

Ground screw clamp terminal blocks

Description	Color	Type	Order code	Pkg qty	Weight (1 pce) g
Ground	Green-yellow	M4/6.4A.P	1SNA195638R2300	50	22.00

All the technical data for UL/CSA standard and dimensions in inches are in *italics*. Technical data valid for copper conductors only.

M6/8 screw clamp terminal blocks

Feed-through - 8 mm 0.315 in spacing



6 mm²
8 AWG

Description

- Flexibility: snap onto symmetrical and asymmetrical rails,
- Many colors are available in addition to our generic grey, to help you quickly identify any of specific functions.

Ordering details

Description	Color	Type	Order code	Pkg qty	Weight (1 pce) g
Feed-through	Grey	M6/8	1SNA115118R1100	50	12.80
	Blue	M6/8.N	1SNA125118R1300	50	12.80
	Orange	M6/8	1SNA105004R2200	50	12.80
	Yellow	M6/8	1SNA105118R2000	50	12.80
	Red	M6/8	1SNA400186R2100	50	12.80
	White	M6/8	1SNA400187R2200	50	12.80
	Black	M6/8	1SNA400239R1500	50	12.80
	Beige	M6/8	1SNA195118R1200	50	12.80

Main technical data

Connecting capacity		IEC	UL	CSA	Mounting instructions	
1 conductor per clamp	Rigid - Solid / Stranded	0.5-10 mm ²	22-8 AWG	24-8 AWG	Rail	G32, TH 35-7.5, TH 35-15
	Flexible with insulated ferrule	0.5-6 mm ²			Wire stripping length	12 mm 0.47 in
	Gauge	A5			Tool	Flat screwdriver Ø 4 - 5 mm Ø 0.157 - 0.197 in
Rated current / Rated cross section		41 A / 6 mm ²	50 A / 8 AWG	50 A / 8 AWG	Torque	0.8 - 1 N.m 7.1 - 8.9 lb.in
Rated short-time withstand current (1s)		720 A				
Rated voltage		1000 V	600 V	600 V		
Impulse withstand voltage		8000 V				
Protection		IP20	NEMA 1			

The connecting capacity data for one Rigid - Solid / Stranded - Flexible conductor (when applicable) is a mandatory information required by IEC, UL and CSA standards. All other data are provided as supplementary information only. For more details, please consult our CB, UL or CSA certificates and technical datasheet available on <http://www.abb.com>

CE	RoHS	USF	CSA	Goost R
----	------	-----	-----	---------



M6/8

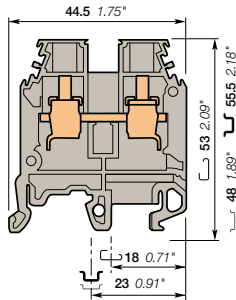

8 mm 0.315 in spacing

Accessories

Description	Color	Type	Order code	Pkg qty	Weight (1 pce) g		
1 End stops	Grey	BAM2	1SNA206351R1600	50	12.00		
		BADL	1SNA399903R0200	50	4.70		
2 End sections	Grey	FEM6	1SNA118368R1600	20	2.40		
3 Jumper bars		2 poles	41 A	BJM18-2	1SNA176669R1600	10	4.50
		3 poles		BJM18-3	1SNA176670R1300	10	6.00
		4 poles		BJM18-4	1SNA176671R0000	10	10.00
		5 poles		BJM18-5	1SNA176672R0100	10	12.22
		10 poles		BJM18-10	1SNA176673R0200	10	20.00
4 Lateral jumper bars		2 poles	50 A	PC8-2	1SNA116538R1700	10	3.00
		10 poles		PC8-10	1SNA163313R2400	10	
5 Cross spacing jumpers		5 mm 0.200 in - 6 mm 0.236 in - 8 mm 0.315 in		EL6	1SNA173627R2100	10	0.10
		Universal screw jumper bar kit N ^{PI}		BJDP1	1SNA179623R0300	10	7.00
6 Circuit separators	Grey	Universal screw jumper bar kit N ^{III}		BJDP3	1SNA179625R0500	10	5.00
		0 mm	0 in	SCM6	1SNA113003R1000	10	0.30
		3 mm	0.118 in	SCFM6	1SNA114825R0500	20	4.00
				SCFCV1-2	1SNA116795R1100	10	8.00
7 Protecting covers	Transparent	Length 1 m 39 in		SCF6	1SNA118707R0300	20	
		Length 500 mm 19.70 in		CPV1-2	1SNA176816R1200	1	
8 Terminal block markers	White	Blank card		CPM	1SNA187312R1400	1	
					RC810	1SNA234000R0200	1

Complete list of accessories is indicated in the terminal block datasheet. Some accessories such as jumper bars may modify the terminal block's ratings: complete information in the accessories catalogue pages.

Ground screw clamp terminal blocks

Description	Color	Type	Order code	Pkg qty	Weight (1 pce) g
Ground	Green-yellow	M6/8.P	1SNA165114R1700	50	26.00

All the technical data for UL/CSA standard and dimensions in inches are in italic. Technical data valid for copper conductors only.

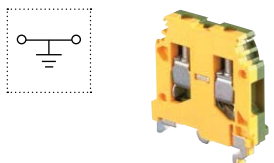
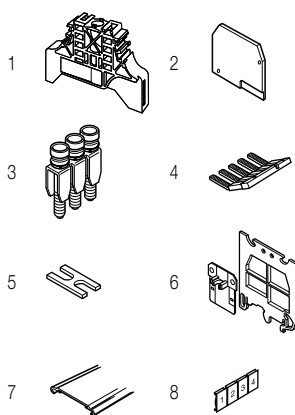

M6/8 screw clamp terminal blocks

Feed-through - 8 mm 0.315 in spacing

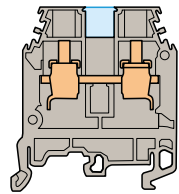

8 mm 0.315 in spacing

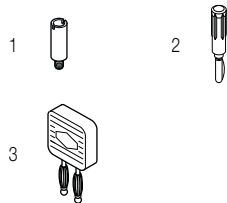

With partition

Ordering details

Description	Color	Type	Order code	Pkg qty	Weight (1 pce) g
Feed-through With partition	Grey <input type="checkbox"/>	M6/8.1	1SNA115260R0300	50	12.80
	Green <input type="checkbox"/>	M6/8.1	1SNA105128R2200	50	12.80
	Beige <input type="checkbox"/>	M6/8.1	1SNA195260R0400	50	12.80
	Blue <input type="checkbox"/>	M6/8.1.N	1SNA125260R0500	50	12.80

Main technical data	IEC	UL	CSA
Rated voltage	1000 V	600 V	600 V
Impulse withstand voltage	8000 V		
Protection	IP20	NEMA 1	



Accessories

Description	Color	Type	Order code	Pkg qty	Weight (1 pce) g
1 Test sockets		AL2	1SNA163043R2100	50	0.90
		AL3	1SNA163261R0000	50	1.20
		AL4-M3	1SNA206721R0100	50	1.10
2 Test plugs	Black <input checked="" type="checkbox"/>	FC2	1SNA007865R2600	100	
	White <input type="checkbox"/>	FC4	1SNA167860R0100	10	10.00
3 Short circuit plugs		BP8.A4	1SNA173888R2000	10	

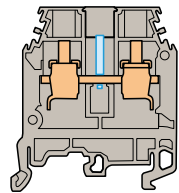
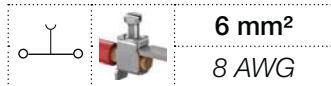

8 mm 0.315 in spacing



With test socket DIA 2 mm 0.079 in

Ordering details

Description	Color	Type	Order code	Pkg qty	Weight (1 pce) g
Feed-through With test socket DIA 2 mm 0.079 in	Grey <input type="checkbox"/>	M6/8.2	1SNA115218R2500	50	12.80

Main technical data	IEC	UL	CSA
Rated voltage	800 V	600 V	600 V
Impulse withstand voltage	8000 V		
Protection	IP20	NEMA 1	

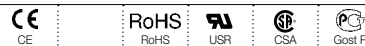

Accessories

Description	Color	Type	Order code	Pkg qty	Weight (1 pce) g
1 Test plugs	Black <input checked="" type="checkbox"/>	FC2	1SNA007865R2600	100	

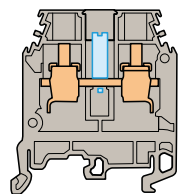

8 mm 0.315 in spacing



With test socket DIA 4 mm 0.157 in

Ordering details

Description	Color	Type	Order code	Pkg qty	Weight (1 pce) g
Feed-through With test socket DIA 4 mm 0.157 in	Grey <input type="checkbox"/>	M6/8.4	1SNA115219R2600	50	12.80

Main technical data	IEC	UL	CSA
Rated voltage	800 V	600 V	600 V
Impulse withstand voltage	8000 V		
Protection	IP10	NEMA	



Accessories

Description	Color	Type	Order code	Pkg qty	Weight (1 pce) g
1 Test plugs	White <input type="checkbox"/>	FC4	1SNA167860R0100	10	10.00
2 Short circuit plugs		BP8.A4	1SNA173888R2000	10	

All the technical data for UL/CSA standard and dimensions in inches are in *italics*.
Technical data valid for copper conductors only.

M10/10 screw clamp terminal blocks

Feed-through - 10 mm 0.394 in spacing



Description

- Flexibility: snap onto symmetrical and asymmetrical rails,
- Many colors are available in addition to our generic grey, to help you quickly identify any of specific functions.

Ordering details

Description	Color	Type	Order code	Pkg qty	Weight (1 pce) g
Feed-through	Grey	M10/10	1SNA115120R1700	50	17.20
	Blue	M10/10.N	1SNA125120R1100	50	17.20
	Yellow	M10/10	1SNA105120R2600	50	17.20
	Red	M10/10	1SNA400189R0400	50	17.20
	White	M10/10	1SNA400190R0100	50	17.20
	Black	M10/10	1SNA400188R0300	50	17.20
	Beige	M10/10	1SNA195120R1000	50	17.20

Main technical data

Connecting capacity		IEC	UL	CSA	Mounting instructions	
1 conductor per clamp	Rigid - Solid / Stranded	0.5-16 mm ²	20-6 AWG	22-6 AWG	Rail	G32, TH 35-7.5, TH 35-15
	Flexible with insulated ferrule	0.5-10 mm ²			Wire stripping length	12 mm 0.47 in
	Gauge	B6			Tool	Flat screwdriver Ø 5.5 - 6 mm Ø 0.217 - 0.236 in
Rated current / Rated cross section		57 A / 10 mm ²	65 A / 6 AWG	70 A / 6 AWG	Torque	1.2 - 1.4 N.m 10.6 - 12.4 lb.in
Rated short-time withstand current (1s)		1200 A				
Rated voltage		1000 V	600 V	600 V		
Impulse withstand voltage		8000 V				
Protection		IP20	NEMA 1			

The connecting capacity data for one Rigid - Solid / Stranded - Flexible conductor (when applicable) is a mandatory information required by IEC, UL and CSA standards.

All other data are provided as supplementary information only. For more details, please consult our CB, UL or CSA certificates and technical datasheet available on <http://www.abb.com>

CE	RoHS	RoHS	USR	CSA	Gost R
----	------	------	-----	-----	--------



M10/10

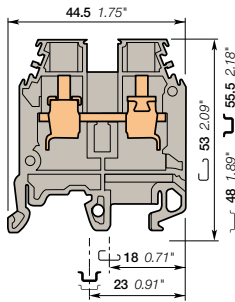

10 mm 0.394 in spacing

Accessories

Description	Color	Type	Order code	Pkg qty	Weight (1 pce) g		
1 End stops	Grey	BAM2	1SNA206351R1600	50	12.00		
		BADL	1SNA399903R0200	50	4.70		
2 End sections	Grey	FEM6	1SNA118368R1600	20	2.40		
3 Jumper bars	Grey	2 poles	BJMI10-2	1SNA176675R0400	50	5.00	
		3 poles	BJMI10-3	1SNA176676R0500	10	8.00	
		4 poles	BJMI10-4	1SNA176677R0600	10	11.00	
		5 poles	BJMI10-5	1SNA176678R1700	10	13.00	
		10 poles	BJMI10-10	1SNA176679R1000	10	27.00	
4 Lateral jumper bars		10 poles	70 A	PC10-10	1SNA163315R2600	10	
5 Cross spacing jumpers	Grey	Universal screw jumper bar kit N ^{PI}	BJDP1	1SNA179623R0300	10	7.00	
		Universal screw jumper bar kit N ^{PIII}	BJDP3	1SNA179625R0500	10	5.00	
6 Circuit separators	Grey	0 mm	0 in	SCM6	1SNA113003R1000	10	0.30
		3 mm	0.118 in	SCFM6	1SNA114825R0500	20	4.00
				SCFCV1-2	1SNA116795R1100	10	8.00
				SCF6	1SNA118707R0300	20	
7 Protecting covers	Transparent	Length 1 m 39 in	CPV1-2	1SNA176816R1200	1		
		Length 500 mm 19.70 in	CPM	1SNA187312R1400	1		
8 Terminal block markers	White	Blank card	RC1010	1SNA238000R1600	1	1.30	

Complete list of accessories is indicated in the terminal block datasheet.

Some accessories such as jumper bars may modify the terminal block's ratings: complete information in the accessories catalogue pages.

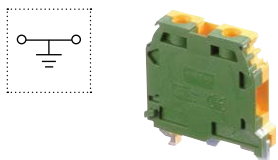
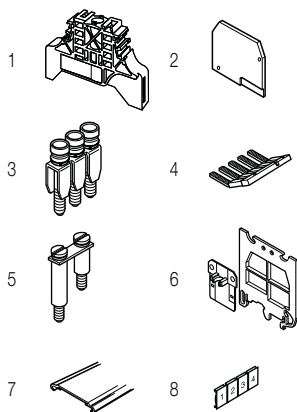

Ground screw clamp terminal blocks

Description	Color	Type	Order code	Pkg qty	Weight (1 pce) g
Ground	Green-yellow	M10/10.P	1SNA165115R1000	50	29.00

All the technical data for UL/CSA standard and dimensions in inches are in *italics*.

Technical data valid for copper conductors only.

M10/10 screw clamp terminal blocks

Feed-through - 10 mm 0.394 in spacing

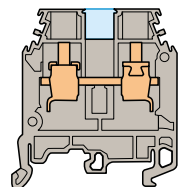

10 mm 0.394 in spacing

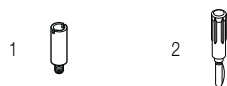

With partition

Ordering details

Description	Color	Type	Order code	Pkg qty	Weight (1 pce) g
Feed-through With partition	Grey <input type="checkbox"/>	M10/10.1	1SNA115261R2000	50	17.20

Main technical data	IEC	UL	CSA	Nota
Rated voltage	1000 V	600 V	600 V	
Impulse withstand voltage	8000 V			
Protection	IP20	NEMA 1		

--	--	--	--	--	--	--	--	--	--	--	--	--	--	--	--	--	--	--	--

Accessories

Description	Color	Type	Order code	Pkg qty	Weight (1 pce) g
1 Test sockets		AL2	1SNA163043R2100	50	0.90
		AL3	1SNA163261R0000	50	1.20
		AL4-M3	1SNA206721R0100	50	1.10
2 Test plugs	Black <input checked="" type="checkbox"/>	FC2	1SNA007865R2600	100	
	White <input type="checkbox"/>	FC4	1SNA167860R0100	10	

All the technical data for UL/CSA standard and dimensions in inches are in italic.
Technical data valid for copper conductors only.

M16/12 screw clamp terminal blocks

Feed-through - 12 mm 0.472 in spacing



16 mm²
6 AWG

2

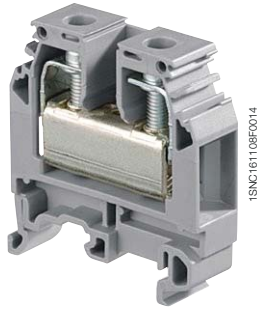

M16/12

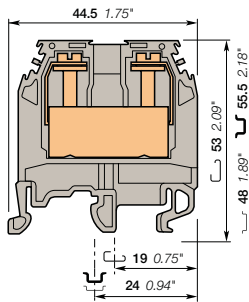

12 mm 0.472 in spacing

Description

- Flexibility: snap onto symmetrical and asymmetrical rails,
- Many colors are available in addition to our generic grey, to help you quickly identify any of specific functions,
- Use of jumper bars requires the user to cut out the partition.

Ordering details

Description	Color	Type	Order code	Pkg qty	Weight (1 pce) g
Feed-through With partition	Grey <input type="checkbox"/>	M16/12	1SNA115129R1400	20	26.12
	Blue <input type="checkbox"/>	M16/12.N	1SNA125129R1600	20	26.12
	Yellow <input type="checkbox"/>	M16/12	1SNA105129R2300	20	26.12
	Red <input type="checkbox"/>	M16/12	1SNA400192R2700	20	26.12
	White <input type="checkbox"/>	M16/12	1SNA400193R2000	20	26.12
	Black <input type="checkbox"/>	M16/12	1SNA400191R2600	20	26.12
	Beige <input type="checkbox"/>	M16/12	1SNA195129R1500	20	26.12

Main technical data

Connecting capacity		IEC	UL	CSA	Rail	G32, TH 35-7.5, TH 35-15
1 conductor per clamp	Rigid - Solid / Stranded	2.5-25 mm ²	18-4 AWG	14-4 AWG	Wire stripping length	14 mm 0.55 in
	Flexible with insulated ferrule	2.5-16 mm ²			Tool	Flat screwdriver Ø 5.5 mm Ø 0.22 in
	Gauge	B7			Torque	1.2 - 1.4 N.m 10.6 - 12.4 lb.in
Rated current / Rated cross section		76 A / 16 mm ²	85 A / 4 AWG	85 A / 4 AWG		
Rated short-time withstand current (1s)		1920 A				
Rated voltage		1000 V	600 V	600 V		
Impulse withstand voltage		8000 V				
Protection		IP20	NEMA 1			

The connecting capacity data for one Rigid - Solid / Stranded - Flexible conductor (when applicable) is a mandatory information required by IEC, UL and CSA standards.

All other data are provided as supplementary information only. For more details, please consult our CB, UL or CSA certificates and technical datasheet available on <http://www.abb.com>

CE	RoHS	RoHS	USR	CSA	Gost R
----	------	------	-----	-----	--------

Accessories

Description	Color	Type	Order code	Pkg qty	Weight (1 pce) g	
1 End stops	Grey <input type="checkbox"/>	BAM2	1SNA206351R1600	50	12.00	
		BADL	1SNA399903R0200	50	4.70	
2 End sections	Grey <input type="checkbox"/>	FEM12	1SNA118618R0100	20	3.20	
3 Jumper bars	Grey <input type="checkbox"/>	2 poles 76 A	BJMI12-2	1SNA179626R0600	10	6.00
		3 poles	BJMI12-3	1SNA179628R1000	10	9.00
		4 poles	BJMI12-4	1SNA179629R1100	10	13.00
		5 poles	BJMI12-5	1SNA179630R1600	10	16.00
		10 poles	BJMI12-10	1SNA179631R0300	10	33.00
4 Cross spacing jumpers	Grey <input type="checkbox"/>	Universal screw jumper bar kit N°II	BJDP2	1SNA179624R0400	10	6.00
		Universal screw jumper bar kit N°III	BJDP3	1SNA179625R0500	10	5.00
5 Circuit separators	Grey <input type="checkbox"/>	3 mm 0.118 in	SCF12	1SNA113102R1000	20	2.00
			SCFM6	1SNA114825R0500	20	4.00
			SCFCV1-2	1SNA116795R1100	10	8.00
			AL2	1SNA163043R2100	50	0.90
6 Test sockets	Grey <input type="checkbox"/>	DIA 2 mm 0.079 in	AL3	1SNA163261R0000	50	1.20
		DIA 3 mm 0.120 in	AL4-M3	1SNA206721R0100	50	1.10
		DIA 4 mm 0.157 in	FC2	1SNA007865R2600	100	
7 Test plugs	Black <input type="checkbox"/>	DIA 2 mm 0.079 in	FC4	1SNA167860R0100	10	
		DIA 4 mm 0.157 in	FC4	1SNA167860R0100	10	
8 Protecting covers	Transparent <input type="checkbox"/>	Length 1 m 39 in	CPV1-2	1SNA176816R1200	1	
		Length 500 mm 19.70 in	CPM	1SNA187312R1400	1	
9 Terminal block markers Blank card	White <input type="checkbox"/>	RC1010	1SNA238000R1600	1	1.30	

Complete list of accessories is indicated in the terminal block datasheet.

Some accessories such as jumper bars may modify the terminal block's ratings: complete information in the accessories catalogue pages.

Ground screw clamp terminal blocks

Description	Color	Type	Order code	Pkg qty	Weight (1 pce) g
Ground Profile aligned with M16/12...	Green-yellow <input type="checkbox"/>	M16/12.P	1SNA165130R2300	20	40.00

All the technical data for UL/CSA standard and dimensions in inches are in italic.

Technical data valid for copper conductors only.

M35/16 screw clamp terminal blocks

Feed-through - 16 mm 0.630 in spacing



M35/16

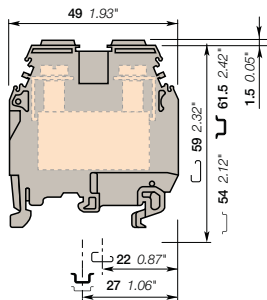

16 mm 0.630 in spacing

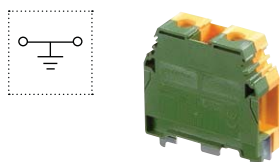
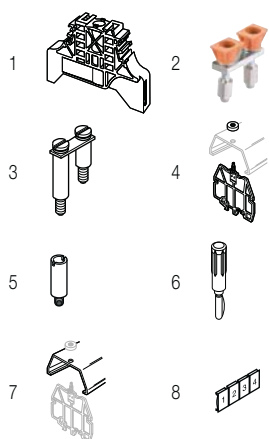

Description

- Closed terminal block: no end section needed, optimized rigidity,
- Flexibility: snap onto symmetrical and asymmetrical rails,
- Use of jumper bars requires the user to cut out the partition.

Ordering details

Description	Color	Type	Order code	Pkg qty	Weight (1 pce) g
Feed-through Closed block with partition	Grey	M35/16	1SNA115124R0700	20	50.00
	Blue	M35/16.N	1SNA125124R0100	20	50.00
	Yellow	M35/16	1SNA105124R1600	20	50.00
	Red	M35/16	1SNA400195R2200	20	50.00
	White	M35/16	1SNA400196R2300	20	50.00
	Black	M35/16	1SNA400194R2100	20	50.00
	Beige	M35/16	1SNA195124R0000	20	50.00

Main technical data

Connecting capacity	IEC	UL	CSA	Mounting instructions
1 conductor per clamp	Rigid - Solid / Stranded Flexible with insulated ferrule Gauge	6-50 mm ² 6-35 mm ² B9	10-0 AWG	10-0 AWG
				Rail: G32, TH 35-7.5, TH 35-15
				Wire stripping length: 17 mm 0.669 in
				Tool: Flat screwdriver Ø 6.5 - 7 mm Ø 0.255 - 0.276 in
Rated current / Rated cross section	125 A / 35 mm ²	150 A / 0 AWG	150 A / 0 AWG	Torque: 2.8 - 3 N.m 24.9 - 26.7 lb.in
Rated short-time withstand current (1s)	4200 A			
Rated voltage	1000 V	600 V	600 V	
Impulse withstand voltage	8000 V			
Protection	IP10	NEMA		

The connecting capacity data for one Rigid - Solid / Stranded - Flexible conductor (when applicable) is a mandatory information required by IEC, UL and CSA standards. All other data are provided as supplementary information only. For more details, please consult our CB, UL or CSA certificates and technical datasheet available on <http://www.abb.com>

CE	RoHS	UL	CSA	Gost R
----	------	----	-----	--------

Accessories

Description	Color	Type	Order code	Pkg qty	Weight (1 pce) g	
1 End stops	Grey	BAM2	1SNA206351R1600	50	12.00	
		BADL	1SNA399903R0200	50	4.70	
2 Jumper bars	Orange	2 poles 125 A	JB16-2	1SNK916302R0000	10	10.20
		3 poles	JB16-3	1SNK916303R0000	10	16.00
		4 poles	JB16-4	1SNK916304R0000	10	21.80
		5 poles	JB16-5	1SNK916305R0000	10	27.60
		10 poles	JB16-10	1SNK916310R0000	10	56.60
3 Cross spacing jumpers	Grey	Universal screw jumper bar kit N°I	BJDP1	1SNA179623R0300	10	7.00
		Universal screw jumper bar kit N°II	BJDP2	1SNA179624R0400	10	6.00
4 Circuit separators	Grey	SCFCV1-2	1SNA116795R1100	10	8.00	
5 Test sockets		AL4-M4	1SNA206723R0300	50	1.30	
6 Test plugs	White	FC4	1SNA167860R0100	10		
7 Protecting covers	Transparent	CPV1-2	1SNA176816R1200	1		
8 Terminal block markers	White	RC1010	1SNA238000R1600	1	1.30	

Complete list of accessories is indicated in the terminal block datasheet. Some accessories such as jumper bars may modify the terminal block's ratings: complete information in the accessories catalogue pages.

Ground screw clamp terminal blocks

Description	Color	Type	Order code	Pkg qty	Weight (1 pce) g
Ground Profile aligned with M35/16...	Green-yellow	M35/16.P	1SNA165111R1400	20	50.50

All the technical data for UL/CSA standard and dimensions in inches are in *italics*. Technical data valid for copper conductors only.

D70/22 screw clamp terminal blocks

Feed-through - 22 mm 0.866 in spacing



2



D70/22

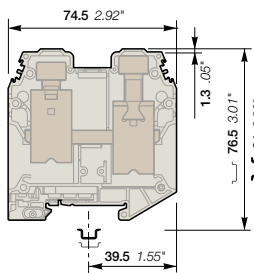

22 mm 0.866 in spacing

Description

- Closed terminal block: no end section needed, optimized rigidity,
- Use of jumper bars requires the user to cut out the partition.

Ordering details

Description	Color	Type	Order code	Pkg qty	Weight (1 pce) g
Feed-through Closed block	Grey <input type="checkbox"/>	D70/22	1SNA400305R1000	10	158.10
	Blue <input type="checkbox"/>	D70/22.N	1SNA400306R1100	10	158.10
	Yellow <input type="checkbox"/>	D70/22.YL	1SNA400789R0000	10	158.10

Main technical data

Connecting capacity	IEC	UL	CSA	Mounting instructions		
1 conductor per clamp	Rigid - Solid / Stranded	16-95 mm ²	4-00 AWG	4-00 AWG	Rail	TH 35-7.5, TH 35-15
	Flexible with insulated ferrule	16-70 mm ²			Wire stripping length	25 mm 0.98 in
	Gauge	B11			Tool	Allen key Ø 6 mm Ø 0.236 in
Rated current / Rated cross section	192 A / 70 mm ²	159 A / 00 AWG	159 A / 00 AWG	Torque	6 - 7 N.m 53.4 - 62.3 lb.in	
Rated short-time withstand current (1s)	8400 A					
Rated voltage	1000 V	600 V	600 V			
Impulse withstand voltage	8000 V					
Protection	IP10	NEMA				

The connecting capacity data for one Rigid - Solid / Stranded - Flexible conductor (when applicable) is a mandatory information required by IEC, UL and CSA standards. All other data are provided as supplementary information only. For more details, please consult our CB, UL or CSA certificates and technical datasheet available on <http://www.abb.com>

CE	CB	RoHS	UL us	CSA	Gost R

Accessories

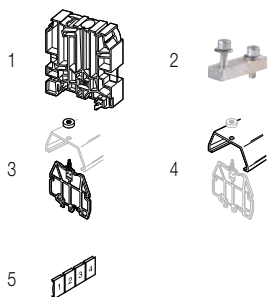

Description	Color	Type	Order code	Pkg qty	Weight (1 pce) g
1 End stops 12 mm	Grey <input type="checkbox"/>	BADH	1SNA116900R2700	50	24.00
2 Jumper bars 2 poles 192 A		JB22-2	1SNK922302R0000	5	27.00
		JB22-3	1SNK922303R0000	5	43.30
		JB22-5	1SNK922305R0000	5	76.10
		JB22-10	1SNK922310R0000	5	157.40
3 Circuit separators 3 mm	Grey <input type="checkbox"/>	SCFCV4	1SNA116797R1300	10	
4 Protecting covers Transparent, length 1 m 39 in	Transparent <input checked="" type="checkbox"/>	CPV4-5	1SNA1176791R2100	1	
5 Terminal block markers Blank card	White <input type="checkbox"/>	RC1010	1SNA238000R1600	1	1.30

Complete list of accessories is indicated in the terminal block datasheet. Some accessories such as jumper bars may modify the terminal block's ratings: complete information in the accessories catalogue pages.

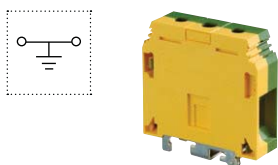

Ground screw clamp terminal blocks

Description	Color	Type	Order code	Pkg qty	Weight (1 pce) g
Ground Profile aligned with D70/22...	Green-yellow <input checked="" type="checkbox"/>	D70/22.P	1SNA400772R1300	10	222.00

All the technical data for UL/CSA standard and dimensions in inches are in italic. Technical data valid for copper conductors only.

D95/26 screw clamp terminal blocks

Feed-through - 26 mm 1.024 in spacing



D95/26

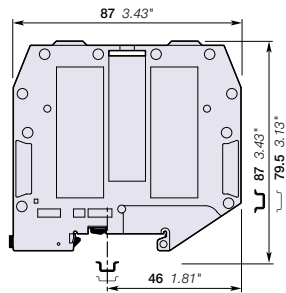

26 mm 1.024 in spacing

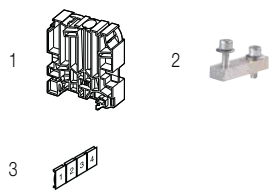

Description

- Closed terminal block: no end section needed, optimized rigidity,
- Use of jumper bars requires the user to cut out the partition.

Ordering details

Description	Color	Type	Order code	Pkg qty	Weight (1 pce) g
Feed-through Closed block with partition	Grey	D95/26	1SNA400370R2400	10	215.00
	Blue	D95/26.N	1SNA400371R1100	10	215.00
	Yellow	D95/26.YL	1SNA400791R0000	10	215.00

Main technical data

Connecting capacity	IEC	UL	CSA	Mounting instructions
1 conductor per clamp	Rigid - Solid / Stranded	35-120 mm ²	2-0000 AWG	2-0000 AWG
	Flexible with insulated ferrule	35-95 mm ²		
	Gauge	B12		
Rated current / Rated cross section	232 A / 95 mm ²	230 A / 0000 AWG	230 A / 0000 AWG	
Rated short-time withstand current (1s)	11400 A			
Rated voltage	1000 V	600 V	600 V	
Impulse withstand voltage	8000 V			
Protection	IP10	NEMA		

Mounting instructions

Rail		TH 35-7.5, TH 35-15
Wire stripping length		26 mm 1.02 in
Tool		Allen key Ø 6 mm Ø 0.236 in
Torque		9 - 9.5 N.m 79.5 - 83.9 lb.in

The connecting capacity data for one Rigid - Solid / Stranded - Flexible conductor (when applicable) is a mandatory information required by IEC, UL and CSA standards. All other data are provided as supplementary information only. For more details, please consult our CB, UL or CSA certificates and technical datasheet available on <http://www.abb.com>

CE	RoHS	UR	CSA	PC	Gost R
----	------	----	-----	----	--------

Accessories

Description	Color	Type	Order code	Pkg qty	Weight (1 pce) g
1 End stops	Grey	BADH	1SNA116900R2700	50	24.00
2 Jumper bars		JB26-2	1SNK926302R0000	5	41.20
		JB26-3	1SNK926303R0000	5	65.70
		JB26-5	1SNK926305R0000	5	115.70
		JB26-10	1SNK926310R0000	5	241.50
3 Terminal block markers	White	RC1010	1SNA23800R1600	1	1.30

Complete list of accessories is indicated in the terminal block datasheet. Some accessories such as jumper bars may modify the terminal block's ratings: complete information in the accessories catalogue pages.

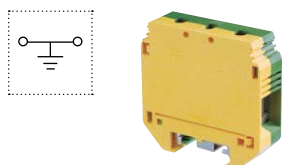

Ground screw clamp terminal blocks

Description	Color	Type	Order code	Pkg qty	Weight (1 pce) g
Ground Profile aligned with D95/26...	Green-yellow	D95/26.P	1SNA400620R1700	10	278.00

All the technical data for UL/CSA standard and dimensions in inches are in *italics*. Technical data valid for copper conductors only.

D150/31.D10 screw clamp terminal blocks

Feed-through - 31 mm 1.220 in spacing



150 mm²

Description

- Use of jumper bars requires the user to cut-out the partition,
- Closed terminal block: no end section needed, optimized rigidity,
- Ease your voltage monitoring or distribution with the two built-in derivations.

Ordering details

Description	Color	Type	Order code	Pkg qty	Weight (1 pce) g
Feed-through Closed block with 2 x 10 mm ² derivations.	Grey	D150/31.D10	1SNA399715R0400	5	385.00
	Blue	D150/31.D10.N	1SNA399717R0600	5	385.00
	Yellow	D150/31.D10.YL	1SNA400778R0000	5	385.00

Main technical data

Connecting capacity	IEC	UL	CSA	Mounting instructions	
Main circuit with 1 conductor per clamp	Rigid - Solid / Stranded	25-185 mm ²		Rail	TH 35-7.5, TH 35-15
	Flexible with insulated ferrule	35-150 mm ²		Wire stripping length	35 mm 1.37 in
Derivation with 1 conductor per clamp	Rigid - Solid / Stranded	0.5-16 mm ²		Tool	Allen key Ø 8 mm Ø 0.315 in
	Flexible with insulated ferrule	0.5-10 mm ²		Torque	10 - 15 N.m 89 - 132 lb.in
Rated current / Rated cross section	Main circuit	309 A / 150 mm ²		Derivation	
	Derivation	57 A / 10 mm ²		Wire stripping length	12 mm 0.47 in
Rated short-time withstand current (1s)		18000 A		Tool	Flat screwdriver Ø 4 mm Ø 0.157 in
Rated voltage		1000 V		Torque	1.2 - 1.4 N.m 10.6 - 12.3 lb.in
Impulse withstand voltage		12000 V			
Protection	IP10		NEMA		

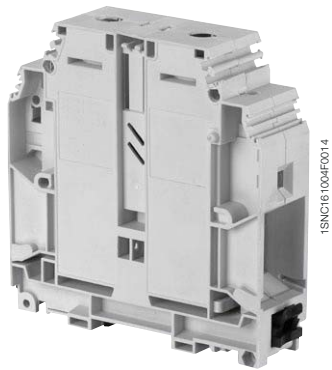

D150/31.D10

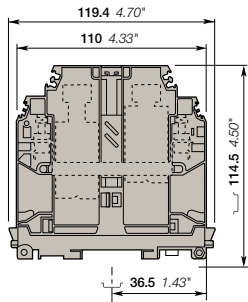

31 mm 1.220 in spacing

The connecting capacity data for one Rigid - Solid / Stranded - Flexible conductor (when applicable) is a mandatory information required by IEC, UL and CSA standards. All other data are provided as supplementary information only. For more details, please consult our CB, UL or CSA certificates and technical datasheet available on <http://www.abb.com>

CE	RoHS	Gost R								
----	------	--------	--	--	--	--	--	--	--	--

IP20 Protection with protecting cover

Partition to cut to fit the wire diameter.

Locking foot operating with screwdriver DIA 4 0.157 in

Sideopening "bistable action". The locking foot remains in open or closed position.

Unlocking **Locking**

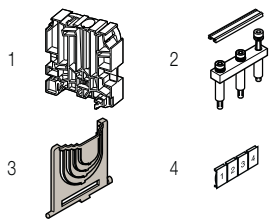

Accessories

Description	Color	Type	Order code	Pkg qty	Weight (1 pce) g
1 End stops 12 mm 0.472 in	Grey	BADH	1SNA116900R2700	50	24.00
2 Jumper bars 2 poles 309 A		BJMI31.2	1SNA206053R0700	1	120.00
		BJMI31.3	1SNA206054R0000	1	190.00
3 Protecting covers		CPBP1	1SNA399788R1600	20	
4 Terminal block markers Blank card	White	RC1010	1SNA238000R1600	1	1.30

Complete list of accessories is indicated in the terminal block datasheet. Some accessories such as jumper bars may modify the terminal block's ratings: complete information in the accessories catalogue pages.

All the technical data for UL/CSA standard and dimensions in inches are in italic. Technical data valid for copper conductors only.

D240/36.D10 screw clamp terminal blocks

Feed-through - 36 mm 1.417 in spacing



240 mm²

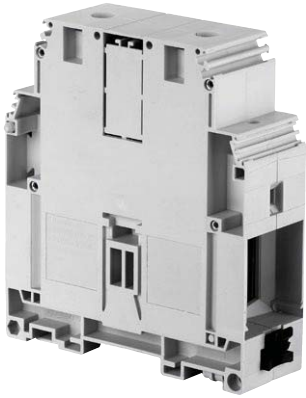

D240/36.D10

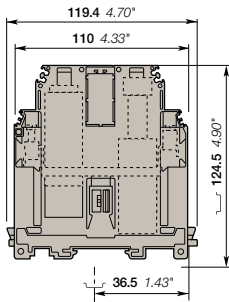

36 mm 1.417 in spacing

Description

- Closed terminal block: no end section needed, optimized rigidity,
- Ease your voltage monitoring or distribution with the 2 built-in derivations,
- Use of jumper bars requires the user to cut out the partition.

Ordering details

Description	Color	Type	Order code	Pkg qty	Weight (1 pce) g
Feed-through Closed block with 2 x 10 mm ² derivations.	Grey	D240/36.D10	1SNA399704R1200	5	542.00
	Blue	D240/36.D10.N	1SNA399706R1400	5	542.00
	Yellow	D240/36.D10.YL	1SNA400779R0000	5	542.00

Main technical data

Connecting capacity	IEC	UL	CSA	Mounting instructions	
Main circuit with 1 conductor per clamp	Rigid - Solid / Stranded	50-300 mm ²		Rail	TH 35-7.5, TH 35-15
	Flexible with insulated ferrule	35-240 mm ²		Main circuit Wire stripping length	35 mm 1.37 in
	Gauge	B14		Tool	Allen key Ø 8 mm Ø 0.39 in
Derivation with 1 conductor per clamp	Rigid - Solid / Stranded	0.5-16 mm ²		Torque	10 - 15 N.m 89 - 132 lb.in
	Flexible with insulated ferrule	0.5-10 mm ²		Derivation Wire stripping length	12 mm 0.47 in
	Gauge	B6		Tool	Flat screwdriver Ø 4 mm Ø 0.157 in
Rated current / Rated cross section				Torque	1.2 - 1.4 N.m 10.6 - 12.3 lb.in
Main circuit		415 A / 240 mm ²			
Derivation		57 A / 10 mm ²			
Rated short-time withstand current (1s)		28800 A			
Rated voltage		1000 V			
Impulse withstand voltage		8000 V			
Protection		IP10	NEMA		

The connecting capacity data for one Rigid - Solid / Stranded - Flexible conductor (when applicable) is a mandatory information required by IEC, UL and CSA standards. All other data are provided as supplementary information only. For more details, please consult our CB, UL or CSA certificates and technical datasheet available on <http://www.abb.com>



IP20 Protection with protecting cover

Locking foot operating with screwdriver DIA 4 0.157 in

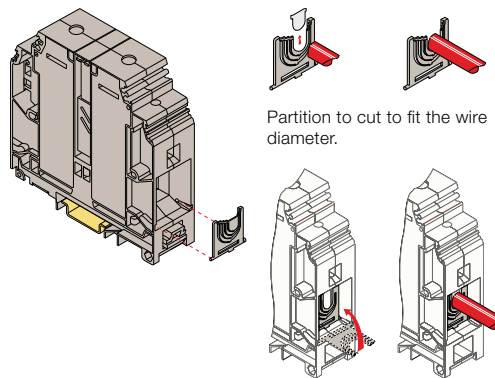

Sideopening "bistable action". The locking foot remains in open or closed position.

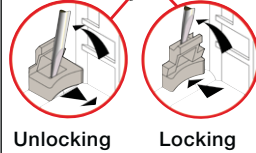

Unlocking Locking

Accessories

Description	Color	Type	Order code	Pkg qty	Weight (1 pce) g
1 End stops 12 mm 0.472 in	Grey	BADH	1SNA116900R2700	50	24.00
2 Jumper bars 2 poles 415 A		BJMI36.2	1SNA206126R2500	1	170.00
		BJMI36.3	1SNA206223R0600	1	260.00
3 Protecting covers		CPBP2	1SNA399787R0500	20	1.30
4 Terminal block markers Blank card	White	RC1010	1SNA238000R1600	1	1.30

Complete list of accessories is indicated in the terminal block datasheet. Some accessories such as jumper bars may modify the terminal block's ratings: complete information in the accessories catalogue pages.

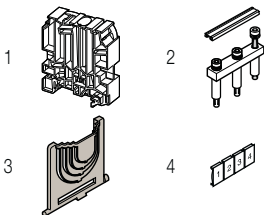

All the technical data for UL/CSA standard and dimensions in inches are in *italics*. Technical data valid for copper conductors only.

MA2.5/5.P screw clamp terminal blocks

Ground - 5 mm 0.197 in spacing



Description

- Reliable electrical and mechanical contact with the rail,
- Flexibility: snap onto symmetrical and asymmetrical rails.

Ordering details

Description	Color	Type	Order code	Pkg qty	Weight (1 pce) g
Ground Screw rail connection	Green-yellow	MA2.5/5.P	1SNA165488R2700	50	18.00

Main technical data

Connecting capacity		IEC	UL	CSA	Mounting instructions	
1 conductor per clamp	Rigid - Solid / Stranded	0.2-4 mm ²	22-12 AWG	22-12 AWG	Rail	G32, TH 35-7.5, TH 35-15
	Flexible with insulated ferrule	0.22-2.5 mm ²			Wire stripping length	10 mm 0.39 in
	Gauge	A3			Screw clamp Tool	Flat screwdriver Ø 3.5 mm Ø 0.14 in
Rated cross section		2.5 mm ²	12 AWG	12 AWG	Torque	0.4 - 0.6 N.m 3.5 - 5.3 lb.in
Rated short-time withstand current (1s)		300 A			Rail connection screw Tool	Flat screwdriver Ø 3.5 mm Ø 0.14 in
					Torque	0.6 N.m 5.5 lb.in

The connecting capacity data for one Rigid - Solid / Stranded - Flexible conductor (when applicable) is a mandatory information required by IEC, UL and CSA standards. All other data are provided as supplementary information only. For more details, please consult our CB, UL or CSA certificates and technical datasheet available on <http://www.abb.com>

CE	RoHS	UL	cCSAus	Gost R
CE	RoHS	USR	cCSAus	Gost R

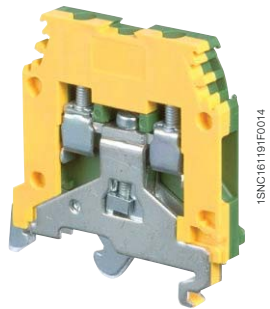

MA2.5/5.P

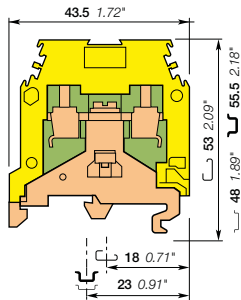

5 mm 0.197 in spacing

Accessories

Description	Color	Type	Order code	Pkg qty	Weight (1 pce) g
1 End stops	Grey	BAM2	1SNA206351R1600	50	12.00
		BADL	1SNA399903R0200	50	4.70
2 End sections	Grey	FEM6	1SNA118368R1600	20	2.40
3 Circuit separators	Grey	SCF6	1SNA118707R0300	20	
4 Terminal block markers	White	RC510	1SNA231000R0700	1	5.20

Complete list of accessories is indicated in the terminal block datasheet. Some accessories such as jumper bars may modify the terminal block's ratings: complete information in the accessories catalogue pages.

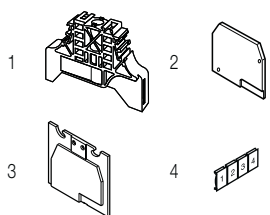

All the technical data for UL/CSA standard and dimensions in inches are in *italics*. Technical data valid for copper conductors only.

D2.5/5.P screw clamp terminal blocks

Ground - 5 mm 0.197 in spacing

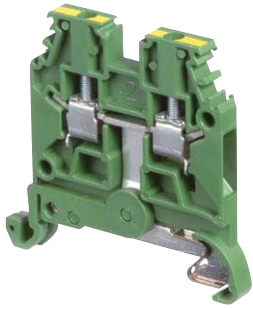

D2.5/5.P

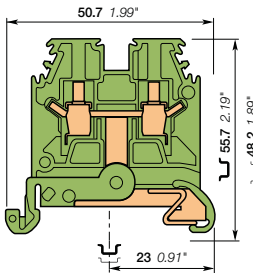

5 mm 0.197 in spacing

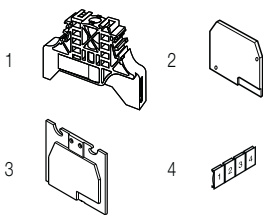

Description

- Screwless rail contact,
- Reliable electrical and mechanical contact with the rail.

Ordering details

Description	Color	Type	Order code	Pkg qty	Weight (1 pce) g
Ground Screwless rail connection	Green-yellow	D2.5/5.P	1SNA165909R0500	50	10.00

Main technical data

Connecting capacity		IEC	UL	CSA	Mounting instructions	
1 conductor per clamp	Rigid - Solid / Stranded	0.2-4 mm ²	24-12 AWG		Rail	TH 35-7.5, TH 35-15
	Flexible with insulated ferrule	0.22-2.5 mm ²			Wire stripping length	10 mm 0.39 in
	Gauge	A3			Screw clamp Tool	Flat screwdriver Ø 3.5 mm Ø 0.14 in
Rated cross section		2.5 mm ²	12 AWG		Torque	0.4 - 0.6 N.m 3.5 - 5.3 lb.in
Rated short-time withstand current (1s)		300 A				

The connecting capacity data for one Rigid - Solid / Stranded - Flexible conductor (when applicable) is a mandatory information required by IEC, UL and CSA standards. All other data are provided as supplementary information only. For more details, please consult our CB, UL or CSA certificates and technical datasheet available on <http://www.abb.com>

CE	RoHS	UL	CSA	PC	Gost R					
CE	RoHS	UL	CSA	PC	Gost R					

Accessories

Description	Color	Type	Order code	Pkg qty	Weight (1 pce) g
1 End stops	Grey	BAM2	1SNA206351R1600	50	12.00
		BADL	1SNA399903R0200	50	4.70
2 End sections	Grey	FEM6	1SNA118368R1600	20	2.40
3 Circuit separators	Grey	SCF6	1SNA118707R0300	20	
4 Terminal block markers	White	RC510	1SNA231000R0700	1	5.20

Complete list of accessories is indicated in the terminal block datasheet. Some accessories such as jumper bars may modify the terminal block's ratings: complete information in the accessories catalogue pages.

All the technical data for UL/CSA standard and dimensions in inches are in italic. Technical data valid for copper conductors only.

M4/6.P screw clamp terminal blocks

Ground - 6 mm 0.236 in spacing

2

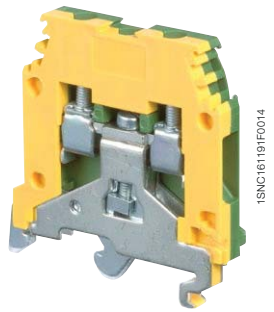

M4/6.P

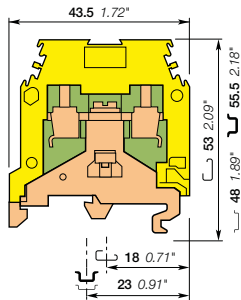

6 mm 0.236 in spacing

Description

- Reliable electrical and mechanical contact with the rail,
- Flexibility: snap onto symmetrical and asymmetrical rails.

Ordering details

Description	Color	Type	Order code	Pkg qty	Weight (1 pce) g
Ground Screw rail connection	Green-yellow	M4/6.P	1SNA165113R1600	50	21.00

Main technical data

Connecting capacity		IEC	UL	CSA	Mounting instructions	
1 conductor per clamp	Rigid - Solid / Stranded	0.2-4 mm ²	22-12 AWG	18-12 AWG	Rail	G32, TH 35-7.5, TH 35-15
	Flexible with insulated ferrule	0.22-4 mm ²			Wire stripping length	9.5 mm 0.37 in
	Gauge	A4			Screw clamp Tool	Flat screwdriver Ø 4 mm Ø 0.16 in
Rated cross section		4 mm ²	12 AWG	12 AWG	Torque	0.5 - 0.8 N.m 4.4 - 7.1 lb.in
Rated short-time withstand current (1s)		480 A			Rail connection screw Tool	Flat screwdriver Ø 4 mm Ø 0.16 in
					Torque	0.8 N.m 7 lb.in

The connecting capacity data for one Rigid - Solid / Flexible conductor (when applicable) is a mandatory information required by IEC, UL and CSA standards. All other data are provided as supplementary information only. For more details, please consult our CB, UL or CSA certificates and technical datasheet available on <http://www.abb.com>

CE	RoHS	UL	CSA	Gost R
CE	RoHS	USR	CSA	Gost R

Accessories

Description	Color	Type	Order code	Pkg qty	Weight (1 pce) g
1 End stops	Grey	BAM2	1SNA206351R1600	50	12.00
		BADL	1SNA399903R0200	50	4.70
2 End sections	Grey	FEM6	1SNA118368R1600	20	2.40
3 Circuit separators	Grey	SCF6	1SNA118707R0300	20	
4 Terminal block markers	White	RC610	1SNA233000R0100	1	7.50

Complete list of accessories is indicated in the terminal block datasheet. Some accessories such as jumper bars may modify the terminal block's ratings: complete information in the accessories catalogue pages.

All the technical data for UL/CSA standard and dimensions in inches are in *italics*. Technical data valid for copper conductors only.

D4/6.P screw clamp terminal blocks

Ground - 6 mm 0.236 in spacing

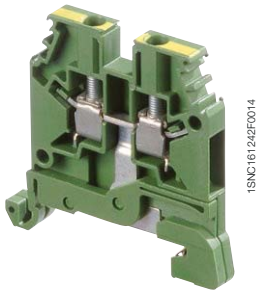

D4/6.P

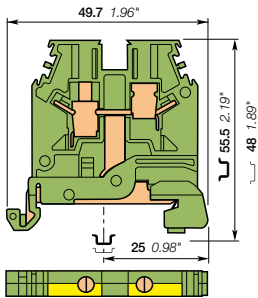

6 mm 0.236 in spacing

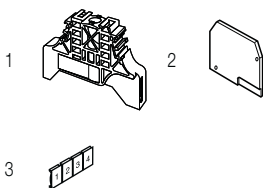

Description

- Screwless rail contact,
- Reliable electrical and mechanical contact with the rail.

Ordering details

Description	Color	Type	Order code	Pkg qty	Weight (1 pce) g
Ground Screwless rail connection	Green-yellow	D4/6.P	1SNA165809R0100	50	12.00

Main technical data

Connecting capacity		IEC	UL	CSA	Mounting instructions	
1 conductor per clamp	Rigid - Solid / Stranded	0.2-4 mm ²	24-12 AWG		Rail	TH 35-7.5, TH 35-15
	Flexible with insulated ferrule	0.22-4 mm ²			Wire stripping length	9.5 mm 0.37 in
	Gauge	A4			Screw clamp Tool	Flat screwdriver Ø 4 mm 0.16 in
Rated cross section		4 mm ²	12 AWG		Torque	0.5 - 0.8 N.m 4.4 - 7.1 lb.in
Rated short-time withstand current (1s)		480 A				

The connecting capacity data for one Rigid - Solid / Stranded - Flexible conductor (when applicable) is a mandatory information required by IEC, UL and CSA standards. All other data are provided as supplementary information only. For more details, please consult our CB, UL or CSA certificates and technical datasheet available on <http://www.abb.com>

CE	RoHS	UL	CSA	Gost R
CE	RoHS	UL	CSA	Gost R

Accessories

Description	Color	Type	Order code	Pkg qty	Weight (1 pce) g
1 End stops	Grey	BAM2	1SNA206351R1600	50	12.00
		BADL	1SNA399903R0200	50	4.70
2 End sections	Grey	FEM6	1SNA118368R1600	20	2.40
3 Terminal block markers	White	RC610	1SNA233000R0100	1	7.50

Complete list of accessories is indicated in the terminal block datasheet. Some accessories such as jumper bars may modify the terminal block's ratings: complete information in the accessories catalogue pages.

All the technical data for UL/CSA standard and dimensions in inches are in italic. Technical data valid for copper conductors only.

M4/6.3A.P screw clamp terminal blocks

Ground - 6 mm 0.236 in spacing



2

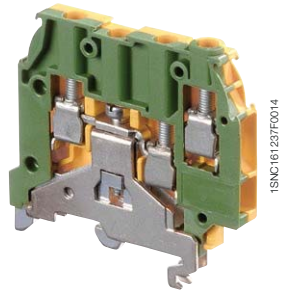

M4/6.3A.P

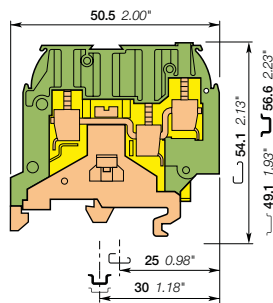

6 mm 0.236 in spacing

Description

- Reliable electrical and mechanical contact with the rail,
- Flexibility: snap onto symmetrical and asymmetrical rails.

Ordering details

Description	Color	Type	Order code	Pkg qty	Weight (1 pce) g
Ground Screw rail connection	Green-yellow	M4/6.3A.P	1SNA195637R1200	50	22.00

Main technical data

Connecting capacity			IEC	UL	CSA	Mounting instructions	
1 conductor per clamp	Rigid - Solid / Stranded		0.2-4 mm ²		24-12 AWG	Rail	G32, TH 35-7.5, TH 35-15
	Flexible with insulated ferrule		0.22-4 mm ²			Wire stripping length	9.5 mm 0.37 in
	Gauge		A4			Screw clamp Tool	Flat screwdriver Ø 4 mm Ø 0.16 in
Rated cross section			4 mm ²		12 AWG	Torque	0.5 - 0.8 N.m 4.4 - 7.1 lb.in
Rated short-time withstand current (1s)			480 A			Rail connection screw Tool	Flat screwdriver Ø 4 mm Ø 0.16 in
						Torque	0.8 N.m 7 lb.in

The connecting capacity data for one Rigid - Solid / Stranded - Flexible conductor (when applicable) is a mandatory information required by IEC, UL and CSA standards. All other data are provided as supplementary information only. For more details, please consult our CB, UL or CSA certificates and technical datasheet available on <http://www.abb.com>

CE	RoHS	CSA	Gost R
CE	RoHS	CSA	Gost R

Accessories

Description	Color	Type	Order code	Pkg qty	Weight (1 pce) g
1 End stops	Grey	BAM2	1SNA206351R1600	50	12.00
		BADL	1SNA399903R0200	50	4.70
2 End sections	Grey	FEM3A	1SNA116576R1500	20	3.30
3 Terminal block markers	White	RC610	1SNA233000R0100	1	7.50

Complete list of accessories is indicated in the terminal block datasheet.

Some accessories such as jumper bars may modify the terminal block's ratings: complete information in the accessories catalogue pages.

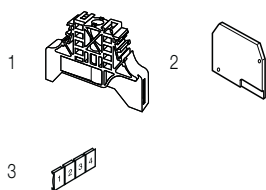

All the technical data for UL/CSA standard and dimensions in inches are in italic. Technical data valid for copper conductors only.

M4/6.4A.P screw clamp terminal blocks

Ground - 6 mm 0.236 in spacing

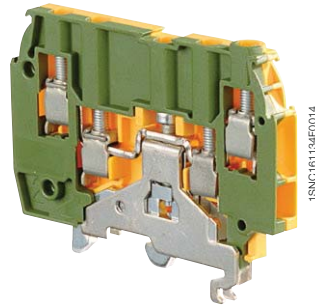

M4/6.4A.P

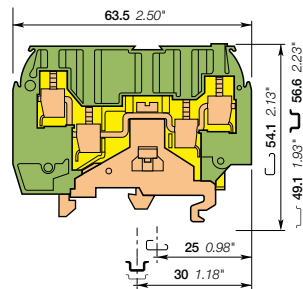

6 mm 0.236 in spacing

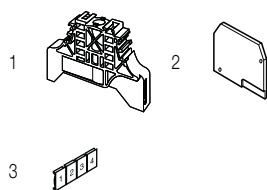

Description

- Reliable electrical and mechanical contact with the rail,
- Flexibility: snap onto symmetrical and asymmetrical rails.

Ordering details

Description	Color	Type	Order code	Pkg qty	Weight (1 pce) g
Ground Screw rail connection	Green-yellow	M4/6.4A.P	1SNA195638R2300	50	22.00

Main technical data

Connecting capacity		IEC	UL	CSA	Mounting instructions	
1 conductor per clamp	Rigid - Solid / Stranded	0.2-4 mm ²			Rail	G32, TH 35-7.5, TH 35-15
	Flexible with insulated ferrule	0.22-4 mm ²			Wire stripping length	9.5 mm 0.37 in
	Gauge	A4			Screw clamp Tool	Flat screwdriver Ø 4 mm Ø 0.16 in
Rated cross section		4 mm ²			Torque	0.5 - 0.8 N.m 4.4 - 7.1 lb.in
Rated short-time withstand current (1s)		480 A			Rail connection screw Tool	Flat screwdriver Ø 4 mm Ø 0.16 in
					Torque	0.8 N.m 7 lb.in

The connecting capacity data for one Rigid - Solid / Stranded - Flexible conductor (when applicable) is a mandatory information required by IEC, UL and CSA standards. All other data are provided as supplementary information only. For more details, please consult our CB, UL or CSA certificates and technical datasheet available on <http://www.abb.com>

CE	RoHS	Gost R				
----	------	--------	--	--	--	--

Accessories

Description	Color	Type	Order code	Pkg qty	Weight (1 pce) g
1 End stops	Grey	BAM2	1SNA206351R1600	50	12.00
		BADL	1SNA399903R0200	50	4.70
2 End sections	Grey	FEM4A	1SNA116629R2200	20	3.80
3 Terminal block markers	White	RC610	1SNA233000R0100	1	7.50

Complete list of accessories is indicated in the terminal block datasheet. Some accessories such as jumper bars may modify the terminal block's ratings: complete information in the accessories catalogue pages.

All the technical data for UL/CSA standard and dimensions in inches are in italic. Technical data valid for copper conductors only.

M6/8.P screw clamp terminal blocks

Ground - 8 mm 0.315 in spacing



2

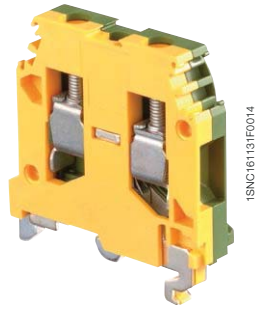

M6/8.P

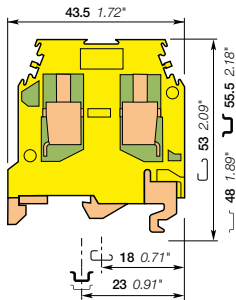

8 mm 0.315 in spacing

Description

- Reliable electrical and mechanical contact with the rail,
- Flexibility: snap onto symmetrical and asymmetrical rails.

Ordering details

Description	Color	Type	Order code	Pkg qty	Weight (1 pce) g
Ground Screw rail connection	Green-yellow	M6/8.P	1SNA165114R1700	50	26.00

Main technical data

Connecting capacity			IEC	UL	CSA	Mounting instructions		
1 conductor per clamp	Rigid - Solid / Stranded	0.5-10 mm ²	22-8 AWG	24-8 AWG	Rail		G32, TH 35-7.5, TH 35-15	
	Flexible with insulated ferrule	0.5-6 mm ²			Wire stripping length		12 mm 0.47 in	
	Gauge	A5			Screw clamp Tool		Flat screwdriver Ø 4 - 5 mm Ø 0.16 - 0.20 in 0.8 - 1 N.m 7.1 - 8.9 lb.in	
Rated cross section			6 mm ²	8 AWG	8 AWG	Torque		Flat screwdriver Ø 4 mm Ø 0.16 in 0.8 N.m 7 lb.in
Rated short-time withstand current (1s)			720 A			Rail connection screw Tool		Flat screwdriver Ø 4 mm Ø 0.16 in 0.8 N.m 7 lb.in
						Torque		0.8 N.m 7 lb.in

The connecting capacity data for one Rigid - Solid / Stranded - Flexible conductor (when applicable) is a mandatory information required by IEC, UL and CSA standards. All other data are provided as supplementary information only. For more details, please consult our CB, UL or CSA certificates and technical datasheet available on <http://www.abb.com>

CE	RoHS	UL	CSA	Gost R
CE	RoHS	USR	CSA	Gost R

Accessories

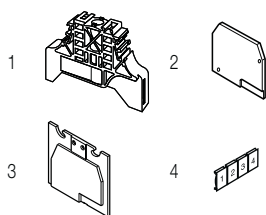

Description	Color	Type	Order code	Pkg qty	Weight (1 pce) g
1 End stops	Grey	BAM2	1SNA206351R1600	50	12.00
		BADL	1SNA399903R0200	50	4.70
2 End sections	Grey	FEM6	1SNA118368R1600	20	2.40
3 Circuit separators	Grey	SCF6	1SNA118707R0300	20	
4 Terminal block markers	White	RC610	1SNA233000R0100	1	7.50

Complete list of accessories is indicated in the terminal block datasheet. Some accessories such as jumper bars may modify the terminal block's ratings: complete information in the accessories catalogue pages.

All the technical data for UL/CSA standard and dimensions in inches are in italic. Technical data valid for copper conductors only.

D6/8.P screw clamp terminal blocks

Ground - 8 mm 0.315 in spacing

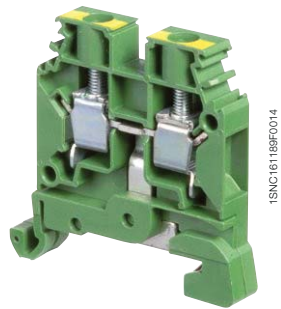

D6/8.P

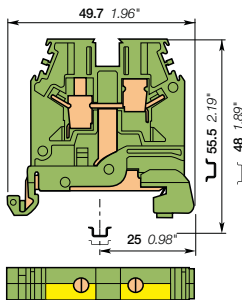

8 mm 0.315 in spacing

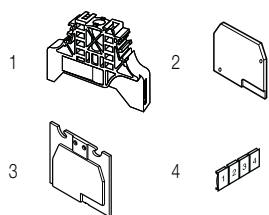

Description

- Screwless rail contact,
- Reliable electrical and mechanical contact with the rail.

Ordering details

Description	Color	Type	Order code	Pkg qty	Weight (1 pce) g
Ground Screwless rail connection	Green-yellow	D6/8.P	1SNA165830R2100	50	16.00

Main technical data

Connecting capacity		IEC	UL	CSA	Mounting instructions	
1 conductor per clamp	Rigid - Solid / Stranded	0.2-10 mm ²	24-8 AWG		Rail	TH 35-7.5, TH 35-15
	Flexible with insulated ferrule	0.22-6 mm ²			Wire stripping length	12 mm 0.47 in
	Gauge	A5			Screw clamp Tool	Flat screwdriver Ø 4 - 5 mm 0.16 - 0.20 in 0.8 - 1 N.m 7.1 - 8.9 lb.in
Rated cross section		6 mm ²	8 AWG		Torque	
Rated short-time withstand current (1s)		720 A				

The connecting capacity data for one Rigid - Solid / Stranded - Flexible conductor (when applicable) is a mandatory information required by IEC, UL and CSA standards. All other data are provided as supplementary information only. For more details, please consult our CB, UL or CSA certificates and technical datasheet available on <http://www.abb.com>

CE	RoHS	UL	CSA	PC	Gost R
CE	RoHS	UL	CSA	PC	Gost R

Accessories

Description	Color	Type	Order code	Pkg qty	Weight (1 pce) g
1 End stops	Grey	BAM2	1SNA206351R1600	50	12.00
		BADL	1SNA399903R0200	50	4.70
2 End sections	Grey	FEM6	1SNA118368R1600	20	2.40
3 Circuit separators	Grey	SCF6	1SNA118707R0300	20	
4 Terminal block markers	White	RC810	1SNA234000R0200	1	8.20

Complete list of accessories is indicated in the terminal block datasheet. Some accessories such as jumper bars may modify the terminal block's ratings: complete information in the accessories catalogue pages.

All the technical data for UL/CSA standard and dimensions in inches are in italic. Technical data valid for copper conductors only.

M10/10.P screw clamp terminal blocks

Ground - 10 mm 0.394 in spacing

2



1SNC161240F0014

M10/10.P

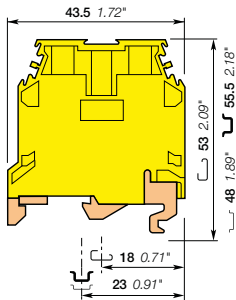

10 mm 0.394 in spacing

Description

- Reliable electrical and mechanical contact with the rail,
- Flexibility: snap onto symmetrical and asymmetrical rails.

Ordering details

Description	Color	Type	Order code	Pkg qty	Weight (1 pce) g
Ground Screw rail connection	Green-yellow	M10/10.P	1SNA165115R1000	50	29.00

Main technical data

Connecting capacity		IEC	UL	CSA	Mounting instructions	
1 conductor per clamp	Rigid - Solid / Stranded	0.5-16 mm ²	20-6 AWG	18-8 AWG	Rail	G32, TH 35-7.5, TH 35-15
	Flexible with insulated ferrule	0.5-10 mm ²			Wire stripping length	12 mm 0.47 in
	Gauge	B6			Screw clamp Tool	Flat screwdriver Ø 5.5 - 6 mm Ø 0.22 - 0.24 in 1.2 - 1.4 N.m 10.6 - 12.4 lb.in
Rated cross section		10 mm ²	6 AWG	8 AWG	Torque	Flat screwdriver Ø 4 mm Ø 0.16 in 0.8 N.m 7 lb.in
Rated short-time withstand current (1s)		1200 A			Rail connection screw Tool	Flat screwdriver Ø 4 mm Ø 0.16 in
					Torque	0.8 N.m 7 lb.in

The connecting capacity data for one Rigid - Solid / Stranded - Flexible conductor (when applicable) is a mandatory information required by IEC, UL and CSA standards. All other data are provided as supplementary information only. For more details, please consult our CB, UL or CSA certificates and technical datasheet available on <http://www.abb.com>

CE	RoHS	UL	CSA	Gost R
CE	RoHS	UL	CSA	Gost R

Accessories

Description	Color	Type	Order code	Pkg qty	Weight (1 pce) g
1 End stops	Grey	BAM2	1SNA206351R1600	50	12.00
		BADL	1SNA399903R0200	50	4.70
2 Circuit separators	Grey	SCFM6	1SNA114825R0500	20	4.00
3 Terminal block markers	White	RC810	1SNA234000R0200	1	8.20
		RC1010	1SNA238000R1600	1	1.30

Complete list of accessories is indicated in the terminal block datasheet. Some accessories such as jumper bars may modify the terminal block's ratings: complete information in the accessories catalogue pages.

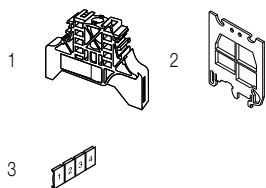

All the technical data for UL/CSA standard and dimensions in inches are in italic. Technical data valid for copper conductors only.

M16/12.P screw clamp terminal blocks

Ground - 12 mm 0.472 in spacing

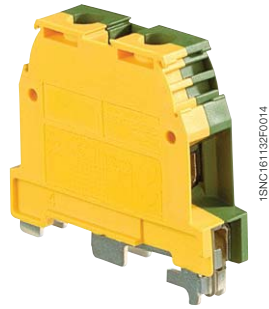

M16/12.P

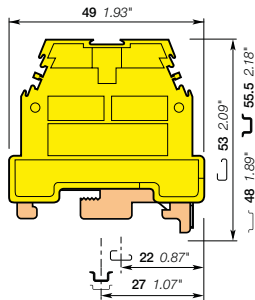

12 mm 0.472 in spacing

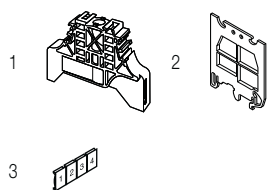

Description

- Reliable electrical and mechanical contact with the rail,
- Flexibility: snap onto symmetrical and asymmetrical rails.

Ordering details

Description	Color	Type	Order code	Pkg qty	Weight (1 pce) g
Ground Screw rail connection	Green-yellow	M16/12.P	1SNA165130R2300	20	40.00

Main technical data

Connecting capacity		IEC	UL	CSA	Mounting instructions	
1 conductor per clamp	Rigid - Solid / Stranded	2.5-25 mm ²	14-4 AWG	10-6 AWG	Rail	G32, TH 35-7.5, TH 35-15
	Flexible with insulated ferrule	2.5-16 mm ²			Wire stripping length	14 mm 0.55 in
	Gauge	B7			Screw clamp Tool	Flat screwdriver Ø 5.5 mm Ø 0.22 in
Rated cross section		16 mm ²	4 AWG	6 AWG	Torque	1.2 - 1.4 N.m 10.6 - 12.4 lb.in
Rated short-time withstand current (1s)		1920 A			Rail connection screw Tool	Flat screwdriver Ø 5.5 mm Ø 0.22 in
					Torque	1 N.m 9 lb.in

The connecting capacity data for one Rigid - Solid / Stranded - Flexible conductor (when applicable) is a mandatory information required by IEC, UL and CSA standards. All other data are provided as supplementary information only. For more details, please consult our CB, UL or CSA certificates and technical datasheet available on <http://www.abb.com>

CE	RoHS	USR	CSA	Gost R
----	------	-----	-----	--------

Accessories

Description	Color	Type	Order code	Pkg qty	Weight (1 pce) g
1 End stops	Grey	BAM2	1SNA206351R1600	50	12.00
		BADL	1SNA399903R0200	50	4.70
2 Circuit separators	Grey	SCFM6	1SNA114825R0500	20	4.00
3 Terminal block markers	White	RC810	1SNA234000R0200	1	8.20
		RC1010	1SNA238000R1600	1	1.30

Complete list of accessories is indicated in the terminal block datasheet. Some accessories such as jumper bars may modify the terminal block's ratings: complete information in the accessories catalogue pages.

M35/16.P screw clamp terminal blocks

Ground - 16 mm 0.630 in spacing



Description

- Reliable electrical and mechanical contact with the rail,
- Flexibility: snap onto symmetrical and asymmetrical rails.

Ordering details

Description	Color	Type	Order code	Pkg qty	Weight (1 pce) g
Ground Screw rail connection	Green-yellow	M35/16.P	1SNA165111R1400	20	50.50

Main technical data

Connecting capacity		IEC	UL	CSA	Mounting instructions	
1 conductor per clamp	Rigid - Solid / Stranded	6-50 mm ²	8-0 AWG	6-4 AWG	Rail	G32, TH 35-7.5, TH 35-15
	Flexible with insulated ferrule	6-35 mm ²			Wire stripping length	17 mm 0.67 in
	Gauge	B9			Screw clamp Tool	Flat screwdriver Ø 8 mm Ø 0.32 in
Rated cross section		35 mm ²	0 AWG	4 AWG	Torque	2.8 - 3 N.m 24.9 - 26.7 lb.in
Rated short-time withstand current (1s)		4200 A			Rail connection screw Tool	Flat screwdriver Ø 5.5 mm Ø 0.22 in
					Torque	2.8 - 3 N.m 24.9 - 26.7 lb.in

The connecting capacity data for one Rigid - Solid / Stranded - Flexible conductor (when applicable) is a mandatory information required by IEC, UL and CSA standards. All other data are provided as supplementary information only. For more details, please consult our CB, UL or CSA certificates and technical datasheet available on <http://www.abb.com>

CE	RoHS	UL	CSA	Gost R
CE	RoHS	USR	CSA	Gost R

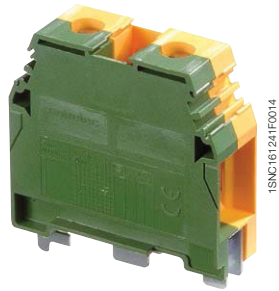

M35/16.P

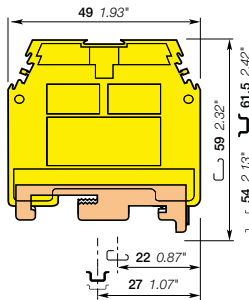

16 mm 0.630 in spacing

Accessories

Description	Color	Type	Order code	Pkg qty	Weight (1 pce) g
1 End stops	Grey	BAM2	1SNA206351R1600	50	12.00
		BADL	1SNA399903R0200	50	4.70
2 Terminal block markers	White	RC810	1SNA234000R0200	1	8.20
		RC1010	1SNA238000R1600	1	1.30

Complete list of accessories is indicated in the terminal block datasheet. Some accessories such as jumper bars may modify the terminal block's ratings: complete information in the accessories catalogue pages.

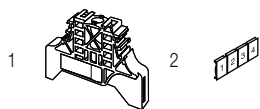

All the technical data for UL/CSA standard and dimensions in inches are in *italics*. Technical data valid for copper conductors only.

D70/22.P screw clamp terminal blocks

Ground - 22 mm 0.866 in spacing

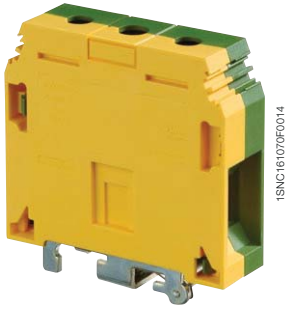

D70/22.P

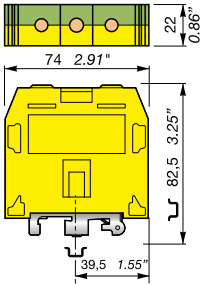

22 mm 0.866 in spacing

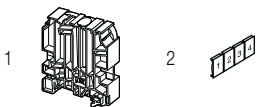

Description

Reliable electrical and mechanical contact with the rail.

Ordering details

Description	Color	Type	Order code	Pkg qty	Weight (1 pce) g
Ground Screw rail connection	Green-yellow	D70/22.P	1SNA400772R1300	10	222.00

Main technical data

Connecting capacity		IEC	UL	CSA	Mounting instructions	
1 conductor per clamp	Rigid - Solid / Stranded	16-95 mm ²	4-00 AWG	4-00 AWG	Rail	TH 35-15
	Flexible with insulated ferrule	16-70 mm ²			Wire stripping length	25 mm 0.984 in
	Gauge	B11			Screw clamp Tool	Allen key Ø 6 mm Ø 0.236 in
					Torque	6 - 7 N.m 53.4 - 62.3 lb.in
Rated cross section		70 mm ²	00 AWG	00 AWG	Rail connection screw Tool	Allen key Ø 4 mm Ø 0.158 in
Rated short-time withstand current (1s)		8400 A	8088 A	8088 A	Torque	1.5 - 2.5 N.m 13.3 - 22.1 lb.in

The connecting capacity data for one Rigid - Solid / Stranded - Flexible conductor (when applicable) is a mandatory information required by IEC, UL and CSA standards. All other data are provided as supplementary information only. For more details, please consult our CB, UL or CSA certificates and technical datasheet available on <http://www.abb.com>

CE	RoHS	UL	CSA	Gost R					
----	------	----	-----	--------	--	--	--	--	--

Accessories

Description	Color	Type	Order code	Pkg qty	Weight (1 pce) g
1 End stops 12 mm 0.472 in	Grey	BADH	1SNA116900R2700	50	24.00
2 Terminal block markers Blank card	White	RC1010	1SNA238000R1600	1	1.30

Complete list of accessories is indicated in the terminal block datasheet. Some accessories such as jumper bars may modify the terminal block's ratings: complete information in the accessories catalogue pages.

All the technical data for UL/CSA standard and dimensions in inches are in italic. Technical data valid for copper conductors only.

D95/26.P screw clamp terminal blocks

Ground - 26 mm 1.024 in spacing



Description

Reliable electrical and mechanical contact with the rail.

Ordering details

Description	Color	Type	Order code	Pkg qty	Weight (1 pce)
Ground Screw rail connection	Green-yellow	D95/26.P	1SNA400620R1700	10	278.00

Main technical data

Connecting capacity		IEC	UL	CSA	Mounting instructions	
1 conductor per clamp	Rigid - Solid / Stranded	35-120 mm ²	2-0000 AWG	2-0000 AWG	Rail	TH 35-15
	Flexible	35-95 mm ²			Wire stripping length	26 mm 1.023 in
	with insulated ferrule				Screw clamp Tool	Allen key Ø 6 mm Ø 0.236 in
	Gauge	B12			Torque	9 - 9.5 N.m 79.5 - 83.9 lb.in
Rated cross section		95 mm ²	0000 AWG	0000 AWG	Rail connection screw Tool	Allen key Ø 4 mm Ø 0.158 in
Rated short-time withstand current (1s)		11400 A	12840 A	12840 A	Torque	1.5 - 2.5 N.m 13.3 - 22.1 lb.in

The connecting capacity data for one Rigid - Solid / Stranded - Flexible conductor (when applicable) is a mandatory information required by IEC, UL and CSA standards. All other data are provided as supplementary information only. For more details, please consult our CB, UL or CSA certificates and technical datasheet available on <http://www.abb.com>

CE	RoHS	UL	CSA	Gost R
CE	RoHS	UL	CSA	Gost R

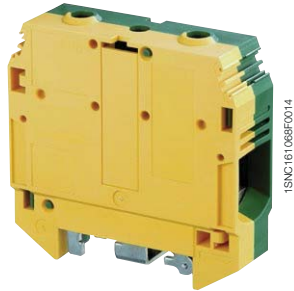

D95/26.P

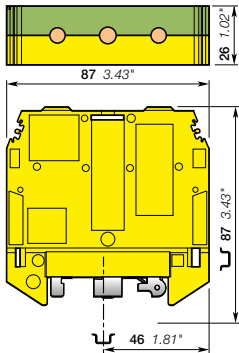

26 mm 1.024 in spacing

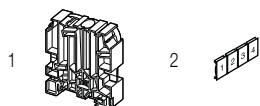

Accessories

Description	Color	Type	Order code	Pkg qty	Weight (1 pce)
1 End stops 12 mm	Grey	BADH	1SNA116900R2700	50	24.00
2 Terminal block markers Blank card	White	RC1010	1SNA238000R1600	1	1.30

Complete list of accessories is indicated in the terminal block datasheet. Some accessories such as jumper bars may modify the terminal block's ratings: complete information in the accessories catalogue pages.

All the technical data for UL/CSA standard and dimensions in inches are in italic. Technical data valid for copper conductors only.

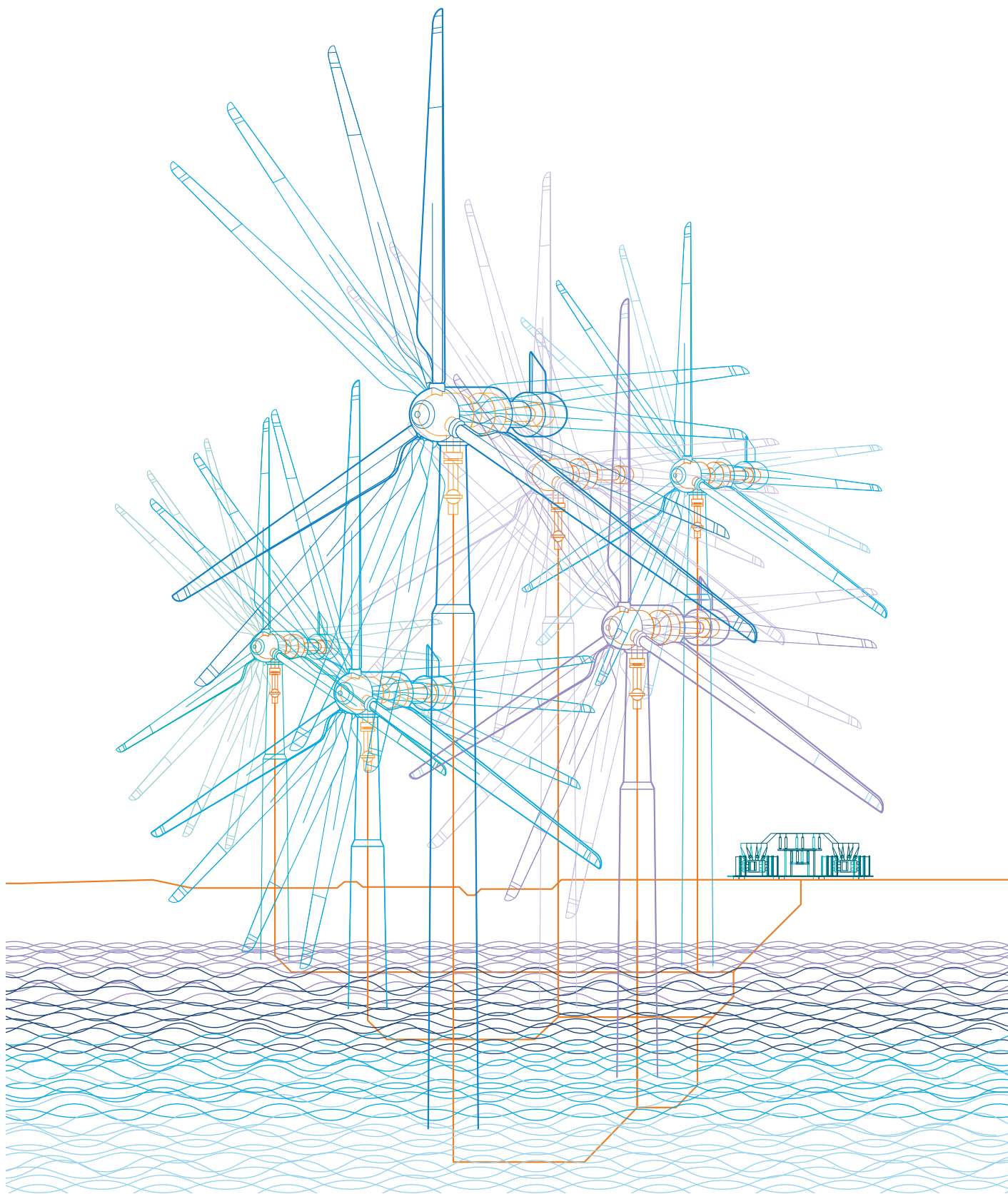

1SNC160053S0201

MA2.5/5.D2 screw clamp terminal blocks

Double deck - 5 mm 0.197 in spacing



2.5 mm²
12 AWG

Description

- Save space with double deck terminal blocks: 2 independent circuits connected in just 5 mm 0.197 in spacing,
- Flexibility: snap onto symmetrical and asymmetrical rails.

Ordering details

Description	Color	Type	Order code	Pkg qty	Weight (1 pce) g
Feed-through 2 feed-through circuits	Grey	MA2.5/5.D2	1SNA115490R1300	50	15.00
	Blue	MA2.5/5.D2.N	1SNA125490R1500	50	15.00
	Beige	MA2.5/5.D2	1SNA195490R1400	50	15.00

Main technical data

Connecting capacity	IEC	UL	CSA
1 conductor per clamp	Rigid - Solid / Stranded	0.2-4 mm ²	22-12 AWG
	Flexible with insulated ferrule	0.22-2.5 mm ²	
	Gauge	A3	
Rated current / Rated cross section		24 A / 2.5 mm ²	20 A / 12 AWG
Rated short-time withstand current (1s)		300 A	
Rated voltage		630 V	300 V
Impulse withstand voltage		8000 V	300 V
Protection		IP20	NEMA 1

Mounting instructions

Rail		G32, TH 35-7.5, TH 35-15
Wire stripping length		9 mm 0.354 in
Tool		Flat screwdriver Ø 3.5 mm Ø 0.138 in
Torque		0.4 - 0.6 N.m 3.5 - 5.3 lb.in

The connecting capacity data for one Rigid - Solid / Stranded - Flexible conductor (when applicable) is a mandatory information required by IEC, UL and CSA standards. All other data are provided as supplementary information only. For more details, please consult our CB, UL or CSA certificates and technical datasheet available on <http://www.abb.com>

CE	RoHS	RoHS	USR	CSA	Gost R
----	------	------	-----	-----	--------



MA2.5/5.D2

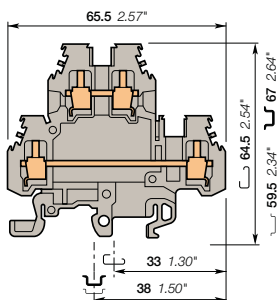

5 mm 0.197 in spacing

Accessories

Description	Color	Type	Order code	Pkg qty	Weight (1 pce) g
1 End stops 12 mm 0.472 in	Grey	BADH	1SNA116900R2700	50	24.00
2 End sections 1 mm 0.039 in	Grey	FEM6D	1SNA118499R2300	20	2.70
3 Jumper bars 2 poles 24 A		BJMI5D-2	1SNA176736R2100	10	2.00
		BJMI5D-3	1SNA176737R2200	10	3.00
		BJMI5D-4	1SNA176738R0300	10	4.00
		BJMI5D-5	1SNA176739R0400	10	6.00
		BJMI5D-10	1SNA176740R1100	10	12.00
4 Lateral jumper bars 2 poles 30 A	Grey	PC5-2	1SNA113542R1000	10	1.80
		PC5-10	1SNA113544R1200	10	6.00
5 Insulating tips For lateral jumper bars type PC...		EIP	1SNA113550R2400	10	
6 Circuit separators 0 mm 0 in	Grey	SCMA5D	1SNA116720R2100	10	
7 Shield connectors		CBM5D	1SNA173530R2400	50	
8 Inner deck jumper bars		ITV5	1SNA176259R1300	20	2.00
9 Terminal block markers Blank card	White	RC510	1SNA231000R0700	1	5.20

Complete list of accessories is indicated in the terminal block datasheet. Some accessories such as jumper bars may modify the terminal block's ratings: complete information in the accessories catalogue pages.

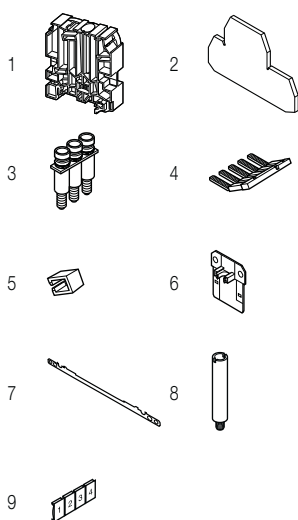

All the technical data for UL/CSA standard and dimensions in inches are in italic. Technical data valid for copper conductors only.

MA2.5/5.D2 screw clamp terminal blocks

Double deck - 5 mm 0.197 in Spacing

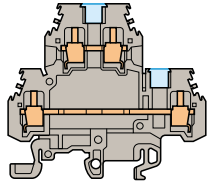

5 mm 0.197 in Spacing



With partition

Ordering Details

Description	Color	Type	Order Code	Pkg qty	Weight (1 pce) g
Feed-through 2 Feed-through circuits with partition	Grey <input type="checkbox"/>	MA2.5/5.D2.1	1SNA115491R0000	50	15.00

Main Technical Data	IEC	UL	CSA	Nota
Rated voltage	630 V	300 V	300 V	
Impulse withstand voltage	8000 V			
Protection	IP20	NEMA 1		

CE	RoHS	USR	CSA	Gost R																
----	------	-----	-----	--------	--	--	--	--	--	--	--	--	--	--	--	--	--	--	--	--

Accessories

Description	Color	Type	Order Code	Pkg qty	Weight (1 pce) g
1 Test Sockets DIA 2 mm 0.079 in		AL2	1SNA164950R0000	50	
2 Test Plugs DIA 2 mm 0.079 in	Black <input checked="" type="checkbox"/>	FC2	1SNA007865R2600	100	

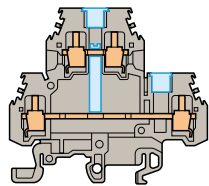
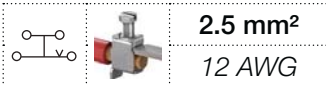

5 mm 0.197 in Spacing



With vertical interconnection and partition

Ordering Details

Description	Color	Type	Order Code	Pkg qty	Weight (1 pce) g
Feed-through 1 Feed-through circuit with vertical interconnection and partition	Grey <input type="checkbox"/>	MA2.5/5.D1.1	1SNA115530R1200	50	15.00

Main Technical Data	IEC	UL	CSA	Nota
Rated voltage	630 V		300 V	
Impulse withstand voltage	8000 V			
Protection	IP20	NEMA 1		

CE	RoHS	CSA	Gost R																	
----	------	-----	--------	--	--	--	--	--	--	--	--	--	--	--	--	--	--	--	--	--

Accessories

Description	Color	Type	Order Code	Pkg qty	Weight (1 pce) g
1 Test Sockets DIA 2 mm 0.079 in		AL2	1SNA164950R0000	50	
2 Test Plugs DIA 2 mm 0.079 in	Black <input checked="" type="checkbox"/>	FC2	1SNA007865R2600	100	

All the technical data for UL/CSA standard and dimensions in inches are in italic.
Technical data valid for copper conductors only.

M4/6.D2 screw clamp terminal blocks

Double deck - 6 mm 0.236 in spacing

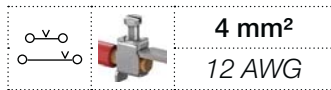

2



1SNC161112P0014

M4/6.D2

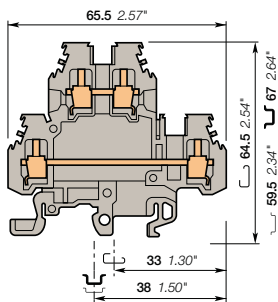

6 mm 0.236 in spacing

Description

- Save space with double deck terminal blocks: 2 independent circuits connected in just 6 mm 0.236 in spacing,
- Flexibility: snap onto symmetrical and asymmetrical rails.

Ordering details

Description	Color	Type	Order code	Pkg qty	Weight (1 pce) g
Feed-through 2 feed-through circuits	Grey	M4/6.D2	1SNA115271R2200	50	20.00
	Blue	M4/6.D2.N	1SNA125271R2400	50	20.00
	Orange	M4/6.D2	1SNA105049R0600	50	20.00
	Yellow	M4/6.D2	1SNA105045R2200	50	20.00
	Green	M4/6.D2	1SNA105044R2100	50	20.00
	Red	M4/6.D2	1SNA105048R0500	50	20.00
	White	M4/6.D2	1SNA105046R2300	50	20.00
	Black	M4/6.D2	1SNA105047R2400	50	20.00
	Beige	M4/6.D2	1SNA195271R2300	50	20.00

Main technical data

Connecting capacity	IEC	UL	CSA
1 conductor per clamp			
Rigid - Solid / Stranded	0.2-4 mm ²	22-12 AWG	24-10 AWG
Flexible with insulated ferrule	0.22-4 mm ²		
Gauge	A4		
Rated current / Rated cross section	32 A / 4 mm ²	20 A / 12 AWG	25 A / 10 AWG
Rated short-time withstand current (1s)	480 A		
Rated voltage	800 V	300 V	600 V
Impulse withstand voltage	8000 V		
Protection	IP20	NEMA 1	

Mounting instructions

Rail		G32, TH 35-7.5, TH 35-15
Wire stripping length		8.5 mm 0.33 in
Tool		Flat screwdriver Ø 4 mm Ø 0.157 in
Torque		0.5 - 0.8 N.m 4.4 - 7.1 lb.in

The connecting capacity data for one Rigid - Solid / Stranded - Flexible conductor (when applicable) is a mandatory information required by IEC, UL and CSA standards. All other data are provided as supplementary information only. For more details, please consult our CB, UL or CSA certificates and technical datasheet available on <http://www.abb.com>

CE	RoHS	UR	CSA	Goet R
----	------	----	-----	--------

Accessories

Description	Color	Type	Order code	Pkg qty	Weight (1 pce) g
1 End stops 12 mm 0.472 in	Grey	BADH	1SNA116900R2700	50	24.00
2 End sections 1 mm 0.039 in	Grey	FEM6D	1SNA118499R2300	20	2.70
3 Jumper bars 2 poles 32 A		BJMI6D-2	1SNA179668R2000	10	4.00
3 poles		BJMI6D-3	1SNA179669R2100	10	6.00
4 poles		BJMI6D-4	1SNA179670R2600	10	8.00
5 poles		BJMI6D-5	1SNA179671R1300	10	10.00
10 poles		BJMI6D-10	1SNA179672R1400	10	20.00
4 Lateral jumper bars 10 poles 35 A		PC61-10	1SNA163311R2200	10	5.00
5 Cross spacing jumpers 5 mm 0.200 in - 6 mm 0.236 in - 8 mm 0.315 in		EL6	1SNA173627R2100	10	0.10
6 Circuit separators 0 mm 0 in	Grey	SCM6D	1SNA113482R0500	10	0.30
1 mm 0.039 in		SCF6D	1SNA118495R1700	20	
7 Shield connectors		CBM5D	1SNA173530R2400	50	
8 Terminal block markers Blank card	White	RC610	1SNA233000R0100	1	7.50

Complete list of accessories is indicated in the terminal block datasheet. Some accessories such as jumper bars may modify the terminal block's ratings: complete information in the accessories catalogue pages.

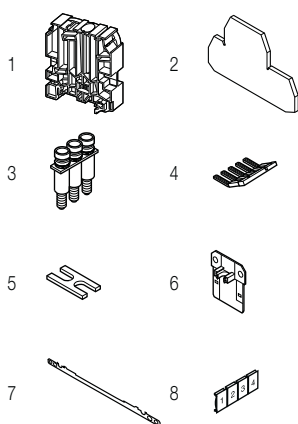

All the technical data for UL/CSA standard and dimensions in inches are in italic. Technical data valid for copper conductors only.

M4/6.D2 screw clamp terminal blocks

Double deck - 6 mm 0.236 in spacing

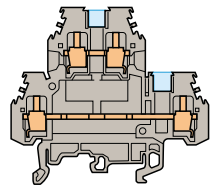

6 mm 0.236 in spacing



With partition

Ordering details

Description	Color	Type	Order code	Pkg qty	Weight (1 pce) g
Feed-through 2 feed-through circuits with partition	Grey <input type="checkbox"/>	M4/6.D2.1	1SNA115126R0100	50	20.00
	Blue <input type="checkbox"/>	M4/6.D2.1.N	1SNA125126R0300	50	20.00

Main technical data	IEC	UL	CSA
Rated voltage	800 V	300 V	600 V
Impulse withstand voltage	8000 V		
Protection	IP20	NEMA 1	

--	--	--	--	--

Accessories

Description	Color	Type	Order code	Pkg qty	Weight (1 pce) g
1 Test sockets DIA 2 mm 0.079 in DIA 3 mm 0.120 in		AL2	1SNA163070R0000	50	20.00
		AL3	1SNA163261R0000	50	1.20
2 Test plugs DIA 2 mm 0.079 in	Black <input checked="" type="checkbox"/>	FC2	1SNA007865R2600	100	

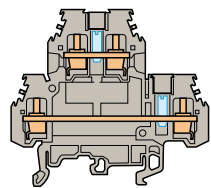
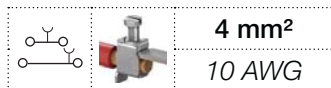

6 mm 0.236 in spacing



With test socket DIA 2 mm 0.079 in

Ordering details

Description	Color	Type	Order code	Pkg qty	Weight (1 pce) g
Feed-through 2 feed-through circuits with 2 tests sockets DIA 2 mm 0.079 in	Grey <input type="checkbox"/>	M4/6.D2.2	1SNA115322R1500	50	20.00

Main technical data	IEC	UL	CSA
Rated voltage	630 V		600 V
Impulse withstand voltage	8000 V		
Protection	IP10	NEMA	

--	--	--	--

Accessories

Description	Color	Type	Order code	Pkg qty	Weight (1 pce) g
1 Test plugs DIA 2 mm 0.079 in	Black <input checked="" type="checkbox"/>	FC2	1SNA007865R2600	100	

All the technical data for UL/CSA standard and dimensions in inches are in italic.
Technical data valid for copper conductors only.

M4/6.D1 screw clamp terminal blocks

Double deck - 6 mm 0.236 in spacing



2



1SNM161206F0014

M4/6.D1

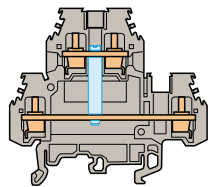

6 mm 0.236 in spacing

Description

- Ease one potential distribution on 4 independent screw clamps,
- Flexibility: snap onto symmetrical and asymmetrical rails.

Ordering details

Description	Color	Type	Order code	Pkg qty	Weight (1 pce) g
Feed-through 1 feed-through circuit	Grey <input type="checkbox"/>	M4/6.D1.1	1SNA115204R2000	50	20.00
	Blue <input type="checkbox"/>	M4/6.D1.1N	1SNA125204R2200	50	20.00

Main technical data

Connecting capacity	IEC	UL	CSA
1 conductor per clamp	Rigid - Solid / Stranded	0.2-4 mm ²	24-10 AWG
	Flexible with insulated ferrule	0.22-4 mm ²	
Gauge	A4		
Rated current / Rated cross section	32 A / 4 mm ²		25 A / 10 AWG
Rated short-time withstand current (1s)	480 A		
Rated voltage	800 V		600 V
Impulse withstand voltage	8000 V		
Protection	IP20	NEMA 1	

Mounting instructions

Rail		G32, TH 35-7.5, TH 35-15
Wire stripping length		8.5 mm 0.33 in
Tool		Flat screwdriver Ø 4 mm Ø 0.16 in
Torque		0.5 - 0.8 N.m 4.4 - 7.1 lb.in

The connecting capacity data for one Rigid - Solid / Stranded - Flexible conductor (when applicable) is a mandatory information required by IEC, UL and CSA standards. All other data are provided as supplementary information only. For more details, please consult our CB, UL or CSA certificates and technical datasheet available on <http://www.abb.com>

CE	RoHS	CSA	Gost R

Accessories

Description	Color	Type	Order code	Pkg qty	Weight (1 pce) g
1 End stops 12 mm 0.472 in	Grey <input type="checkbox"/>	BADH	1SNA116900R2700	50	24.00
2 End sections 1 mm 0.039 in	Grey <input type="checkbox"/>	FEM6D	1SNA118499R2300	20	2.70
3 Jumper bars 2 poles 32 A		BJMI6D-2	1SNA179668R2000	10	4.00
		BJMI6D-3	1SNA179669R2100	10	6.00
		BJMI6D-4	1SNA179670R2600	10	8.00
		BJMI6D-5	1SNA179671R1300	10	10.00
		BJMI6D-10	1SNA179672R1400	10	20.00
4 Lateral jumper bars 10 poles 35 A		PC61-10	1SNA163311R2200	10	5.00
5 Cross spacing jumpers 5 mm 0.200 in - 6 mm 0.236 in - 8 mm 0.315 in		EL6	1SNA173627R2100	10	0.10
6 Circuit separators 0 mm 0 in	Grey <input type="checkbox"/>	SCM6D	1SNA113482R0500	10	0.30
		SCF6D	1SNA118495R1700	20	
7 Shield connectors 1 mm 0.039 in		CBM5D	1SNA173530R2400	50	
8 Terminal block markers Blank card	White <input type="checkbox"/>	RC610	1SNA233000R0100	1	7.50

Complete list of accessories is indicated in the terminal block datasheet. Some accessories such as jumper bars may modify the terminal block's ratings: complete information in the accessories catalogue pages.

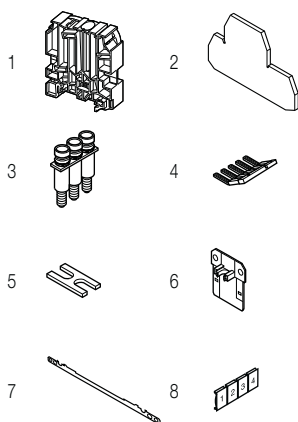

All the technical data for UL/CSA standard and dimensions in inches are in italic. Technical data valid for copper conductors only.

M4/6.D1 screw clamp terminal blocks

Double deck - 6 mm 0.236 in spacing



4 mm²
10 AWG

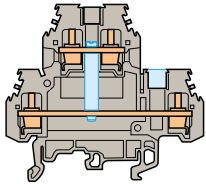

6 mm 0.236 in spacing



With vertical interconnection and partition

Ordering details

Description	Color	Type	Order code	Pkg qty	Weight (1 pce) g
Feed-through 1 feed-through circuit with vertical interconnection and partition	Grey <input type="checkbox"/>	M4/6.D1	1SNA115166R1100	50	20.00
	Blue <input type="checkbox"/>	M4/6.D1.N	1SNA125166R1300	50	20.00

Main technical data	IEC	UL	CSA	Nota
Rated voltage	800 V		600 V	
Impulse withstand voltage	8000 V			
Protection	IP20	NEMA 1		

CE CE	RoHS RoHS	CSA CSA	Gost R Gost R							
----------	--------------	------------	------------------	--	--	--	--	--	--	--

Accessories

Description	Color	Type	Order code	Pkg qty	Weight (1 pce) g
1 Test sockets		AL2	1SNA163070R0000	50	
		AL3	1SNA163261R0000	50	1.20
2 Test plugs	Black <input checked="" type="checkbox"/>	FC2	1SNA007865R2600	100	

All the technical data for UL/CSA standard and dimensions in inches are in italic.
Technical data valid for copper conductors only.

M6/8.D screw clamp terminal blocks

Double deck - 8 mm 0.315 in spacing



6 mm²
8 AWG

2



M6/8.D

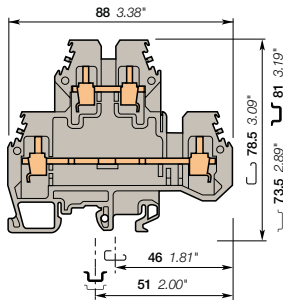

8 mm 0.315 in spacing

Description

- Save space with double deck terminal blocks: 2 independent circuits,
- Flexibility: snap onto symmetrical and asymmetrical rails.

Ordering details

Description	Color	Type	Order code	Pkg qty	Weight (1 pce) g
Feed-through 2 feed-through circuits	Grey <input type="checkbox"/>	M6/8.D2	1SNA115501R1200	50	33.00
	Beige <input type="checkbox"/>	M6/8.D2	1SNA195501R1300	50	33.00

Main technical data

Connecting capacity	IEC	UL	CSA	Mounting instructions	
1 conductor per clamp	Rigid - Solid / Stranded	0.5-10 mm ²	18-8 AWG	8 AWG	Rail G32, TH 35-7.5, TH 35-15
	Flexible with insulated ferrule	0.5-6 mm ²			Wire stripping length 12 mm 0.47 in
Gauge	A5				Tool Flat screwdriver Ø 4 - 5 mm Ø 0.157 - 0.197 in
Rated current / Rated cross section	41 A / 6 mm ²	50 A / 8 AWG	45 A / 8 AWG		Torque 0.8 - 1 N.m 7.1 - 8.9 lb.in
Rated short-time withstand current (1s)	720 A				
Rated voltage	800 V	600 V	600 V		
Impulse withstand voltage	8000 V				
Protection	IP20	NEMA 1			

The connecting capacity data for one Rigid - Solid / Stranded - Flexible conductor (when applicable) is a mandatory information required by IEC, UL and CSA standards. All other data are provided as supplementary information only. For more details, please consult our CB, UL or CSA certificates and technical datasheet available on <http://www.abb.com>

CE	RoHS	UL	CSA	Gost R						

Accessories

Description	Color	Type	Order code	Pkg qty	Weight (1 pce) g
1 End stops 12 mm 0.472 in	Grey <input type="checkbox"/>	BADH	1SNA116900R2700	50	24.00
2 End sections 1 mm 0.039 in	Grey <input type="checkbox"/>	FEM8D1	1SNA116656R2500	20	10.00
3 Jumper bars 2 poles 41 A		BJM8-2	1SNA176669R1600	10	4.50
		BJM8-3	1SNA176670R1300	10	6.00
		BJM8-4	1SNA176671R0000	10	10.00
		BJM8-5	1SNA176672R0100	10	12.22
		BJM8-10	1SNA176673R0200	10	20.00
4 Circuit separators 0 mm 0 in	Grey <input type="checkbox"/>	SCM6	1SNA113003R1000	10	0.30
5 Terminal block markers Blank card	White <input type="checkbox"/>	RC810	1SNA234000R0200	1	8.20

Complete list of accessories is indicated in the terminal block datasheet. Some accessories such as jumper bars may modify the terminal block's ratings: complete information in the accessories catalogue pages.

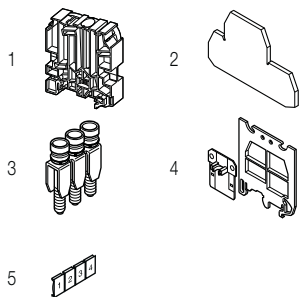

All the technical data for UL/CSA standard and dimensions in inches are in *italics*. Technical data valid for copper conductors only.

M6/8.D screw clamp terminal blocks

Double deck - 8 mm 0.315 in spacing

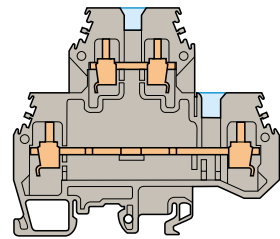

8 mm 0.315 in spacing



With partition

Ordering details

Description	Color	Type	Order code	Pkg qty	Weight (1 pce) g
Feed-through 2 feed-through circuits with partition	Grey <input type="checkbox"/>	M6/8.D2.1	1SNA115497R0600	50	33.00

Main technical data	IEC	UL	CSA	Nota
Rated voltage	800 V	600 V	600 V	
Impulse withstand voltage	8000 V			
Protection	IP20	NEMA 1		



Accessories

Description	Color	Type	Order code	Pkg qty	Weight (1 pce) g
1 Test sockets		AL2	1SNA163043R2100	50	0.90
		AL3	1SNA163261R0000	50	1.20
2 Test plugs	Black <input checked="" type="checkbox"/>	FC2	1SNA007865R2600	100	
	White <input type="checkbox"/>	FC4	1SNA167860R0100	10	

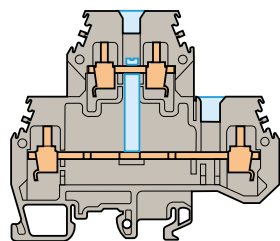
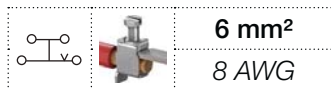

8 mm 0.315 in spacing



With vertical interconnection and partition

Ordering details

Description	Color	Type	Order code	Pkg qty	Weight (1 pce) g
Feed-through 1 feed-through circuit with vertical interconnection and partition	Grey <input type="checkbox"/>	M6/8.D1	1SNA115498R1700	50	36.00

Main technical data	IEC	UL	CSA	Nota
Rated voltage	800 V	600 V	600 V	
Impulse withstand voltage	8000 V			
Protection	IP20	NEMA 1		

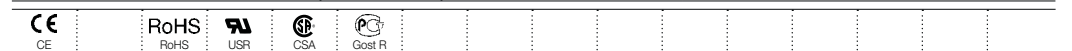

Accessories

Description	Color	Type	Order code	Pkg qty	Weight (1 pce) g
1 Test sockets		AL2	1SNA163043R2100	50	0.90
		AL3	1SNA163261R0000	50	1.20
2 Test plugs	Black <input checked="" type="checkbox"/>	FC2	1SNA007865R2600	100	
	White <input type="checkbox"/>	FC4	1SNA167860R0100	10	

All the technical data for UL/CSA standard and dimensions in inches are in italic. Technical data valid for copper conductors only.

D2.5/6.DP screw clamp terminal blocks

Double deck + ground - 6 mm 0.236 in spacing



2.5 mm²
12 AWG

Description

- Save space with triple deck terminal blocks: 2 independent circuits in just 6 mm 0.236 in spacing,
- Adapted for 2 wires sensor/actuator with ground.

Ordering details

Description	Color	Type	Order code	Pkg qty	Weight (1 pce) g
Feed-through + ground For 2 wires sensor with ground - 2 feed-through circuits - 1 ground circuit	Grey, Green-Yellow	D2.5/6.DPA1	1SNA115643R2700	25	16.00

Main technical data

Connecting capacity		IEC	UL	CSA	Mounting instructions	
1 conductor per clamp	Rigid - Solid / Stranded	0.2-2.5 mm ²	20-12 AWG	22-14 AWG	Rail	G32, TH 35-7.5, TH 35-15
	Flexible with insulated ferrule	0.22-2.5 mm ²			Wire stripping length	6 mm 0.24 in
	Gauge	A2			Tool	Flat screwdriver Ø 3.5 mm Ø 0.138 in
Rated current / Rated cross section		22 A / 2.5 mm ²	26 A / 12 AWG	20 A / 14 AWG	Torque	0.4 - 0.6 N.m 3.5 - 5.3 lb.in
Rated short-time withstand current (1s)		300 A				
Rated voltage		380 V	300 V	300 V		
Impulse withstand voltage						
Protection		IP20	NEMA 1			

The connecting capacity data for one Rigid - Solid / Stranded - Flexible conductor (when applicable) is a mandatory information required by IEC, UL and CSA standards. All other data are provided as supplementary information only. For more details, please consult our CB, UL or CSA certificates and technical datasheet available on <http://www.abb.com>

CE	RoHS	UL	CSA	Gost R					
CE	RoHS	UL	CSA	Gost R					

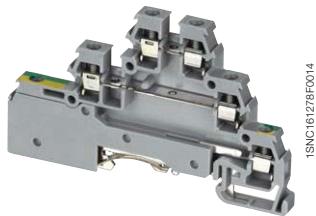

D2.5/6.DP

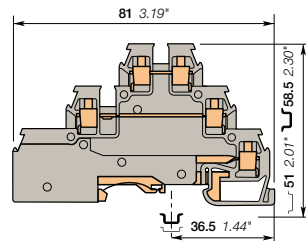

6 mm 0.236 in spacing

Mounting instructions

Connecting capacity		IEC	UL	CSA	Mounting instructions	
1 conductor per clamp	Rigid - Solid / Stranded	0.2-2.5 mm ²	20-12 AWG	22-14 AWG	Rail	G32, TH 35-7.5, TH 35-15
	Flexible with insulated ferrule	0.22-2.5 mm ²			Wire stripping length	6 mm 0.24 in
	Gauge	A2			Tool	Flat screwdriver Ø 3.5 mm Ø 0.138 in
Rated current / Rated cross section		22 A / 2.5 mm ²	26 A / 12 AWG	20 A / 14 AWG	Torque	0.4 - 0.6 N.m 3.5 - 5.3 lb.in
Rated short-time withstand current (1s)		300 A				
Rated voltage		380 V	300 V	300 V		
Impulse withstand voltage						
Protection		IP20	NEMA 1			

The connecting capacity data for one Rigid - Solid / Stranded - Flexible conductor (when applicable) is a mandatory information required by IEC, UL and CSA standards. All other data are provided as supplementary information only. For more details, please consult our CB, UL or CSA certificates and technical datasheet available on <http://www.abb.com>

CE	RoHS	UL	CSA	Gost R					
CE	RoHS	UL	CSA	Gost R					

Accessories

Description	Color	Type	Order code	Pkg qty	Weight (1 pce) g
1 End stops 12 mm 0.472 in	Grey	BADH	1SNA116900R2700	50	24.00
2 End sections 3 mm 0.118 in	Grey	FED3E	1SNA116771R2000	20	3.80
3 Jumper bars 2 poles 22 A		BJD6	1SNA178024R2500	10	1.00
	3 poles		1SNA178025R2600	10	2.00
	4 poles		1SNA178026R2700	10	2.00
	5 poles		1SNA178027R2000	10	3.00
	10 poles		1SNA178032R2500	10	6.00
	20 poles		1SNA178033R2600	5	12.00
4 Cross spacing jumpers 5 mm 0.200 in - 6 mm 0.236 in - 8 mm 0.315 in		EL61	1SNA177812R1700	10	0.10
5 Terminal block markers Blank card	White	RC65	1SNA232000R0000	1	3.60

Complete list of accessories is indicated in the terminal block datasheet. Some accessories such as jumper bars may modify the terminal block's ratings: complete information in the accessories catalogue pages.

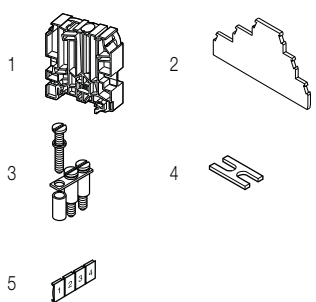

All the technical data for UL/CSA standard and dimensions in inches are in italic. Technical data valid for copper conductors only.

D2.5/6.DA screw clamp terminal blocks

Triple deck - 6 mm 0.236 in spacing



D2.5/6.DA

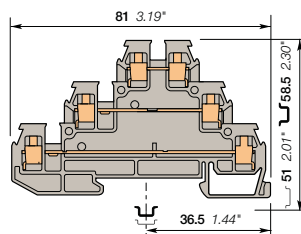

6 mm 0.236 in spacing

Description

- Save space with triple deck terminal blocks: 3 independent circuits connected in just 6 mm 0.236 in spacing,
- Adapted for 3 wires sensor/actuator.

Ordering details

Description	Color	Type	Order code	Pkg qty	Weight (1 pce) g
Feed-through For 3 wires sensor - 3 feed-through circuits	Grey <input type="checkbox"/>	D2.5/6.DA	1SNA115541R1100	25	13.00

Main technical data

Connecting capacity	IEC	UL	CSA	Mounting instructions
1 conductor per clamp	Rigid - Solid / Stranded Flexible with insulated ferrule Gauge	0.2-2.5 mm ² 0.22-2.5 mm ² A2	20-12 AWG	22-14 AWG
Rated current / Rated cross section	22 A / 2.5 mm ²	26 A / 12 AWG	20 A / 14 AWG	
Rated short-time withstand current (1s)	300 A			
Rated voltage	380 V	300 V	300 V	
Impulse withstand voltage				
Protection	IP20	NEMA 1		

The connecting capacity data for one Rigid - Solid / Stranded - Flexible conductor (when applicable) is a mandatory information required by IEC, UL and CSA standards. All other data are provided as supplementary information only, for more details, please consult our CB, UL or CSA certificates and technical datasheet available on <http://www.abb.com>

--	--	--	--	--

Accessories

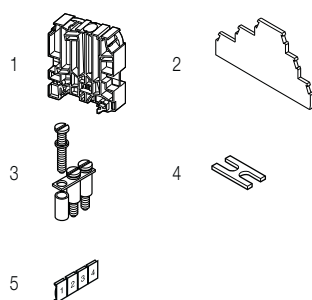

Description	Color	Type	Order code	Pkg qty	Weight (1 pce) g
1 End stops 12 mm 0.472 in	Grey <input type="checkbox"/>	BADH	1SNA116900R2700	50	24.00
2 End sections 3 mm 0.118 in	Grey <input type="checkbox"/>	FED3E	1SNA116771R2000	20	3.80
3 Jumper bars 2 poles 22 A		BJD6	1SNA178024R2500	10	1.00
3 poles			1SNA178025R2600	10	2.00
4 poles			1SNA178026R2700	10	2.00
5 poles			1SNA178027R2000	10	3.00
10 poles			1SNA178032R2500	10	6.00
20 poles			1SNA178033R2600	5	12.00
4 Cross spacing jumpers 5 mm 0.200 in - 6 mm 0.236 in - 8 mm 0.315 in		EL61	1SNA177812R1700	10	0.10
5 Terminal block markers Blank card	White <input type="checkbox"/>	RC65	1SNA232000R0000	1	3.60

Complete list of accessories is indicated in the terminal block datasheet. Some accessories such as jumper bars may modify the terminal block's ratings: complete information in the accessories catalogue pages.

All the technical data for UL/CSA standard and dimensions in inches are in italic. Technical data valid for copper conductors only.

D4/6.T screw clamp terminal blocks

Triple deck - 6 mm 0.236 in spacing



2

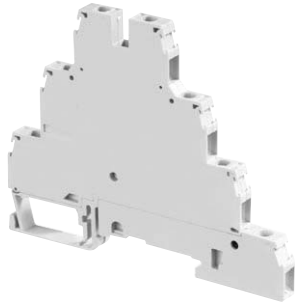

1SNC16 1072F0014

D4/6.T

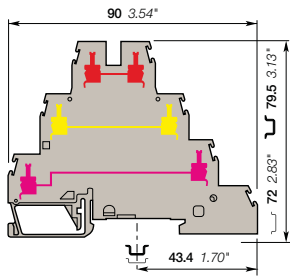

6 mm 0.236 in spacing

Description

Save space with triple deck terminal blocks: 3 independent circuits connected in just 6 mm 0.236 in spacing;
– closed terminal block: no end section needed, optimized rigidity.

Ordering details

Description	Color	Type	Order code	Pkg qty	Weight (1 pce) g
Feed-through 3 feed-through circuits	Grey <input type="checkbox"/>	D4/6.T3	1SNA299683R0100	25	27.00

Main technical data

Connecting capacity		IEC	UL	CSA	Mounting instructions	
1 conductor per clamp	Rigid - Solid / Stranded	0.2-4 mm ²	22-12 AWG		Rail	G32, TH 35-7.5, TH 35-15
	Flexible with insulated ferrule	0.22-4 mm ²			Wire stripping length	9.5 mm 0.37 in
	Gauge	A4			Tool	Flat screwdriver Ø 4 mm Ø 0.16 in
Rated current / Rated cross section		32 A / 4 mm ²	20 A / 12 AWG		Torque	0.5 - 0.8 N.m 4.4 - 7.1 lb.in
Rated short-time withstand current (1s)		480 A				
Rated voltage		500 V	300 V			
Impulse withstand voltage		6000 V				
Protection		IP20	NEMA 1			

The connecting capacity data for one Rigid - Solid / Stranded - Flexible conductor (when applicable) is a mandatory information required by IEC, UL and CSA standards. All other data are provided as supplementary information only, for more details, please consult our CB, UL or CSA certificates and technical datasheet available on <http://www.abb.com>

CE	RoHS	UL	CSA	PC	Gost R
CE	RoHS	UL	CSA	PC	Gost R

Accessories

Description	Color	Type	Order code	Pkg qty	Weight (1 pce) g
1 End stops 12 mm 0.472 in	Grey <input type="checkbox"/>	BADH	1SNA116900R2700	50	24.00
2 Jumper bars 2 poles 32 A		BJM62	1SNA173217R2600	10	2.00
			1SNA173218R0700	10	3.00
			1SNA173219R0000	10	4.00
			1SNA173221R2200	10	5.00
			1SNA173226R2700	10	10.00
3 Lateral jumper bars 10 poles 35 A		PC61-10	1SNA163311R2200	10	5.00
4 Circuit separators 1.5 mm 0.059 in	White <input type="checkbox"/>	SCD	1SNA103189R2600	10	1.00
5 Test sockets DIA 2 mm 0.079 in		AL2	1SNA167319R0600	50	
6 Test plugs DIA 2 mm 0.079 in	Black <input type="checkbox"/>	FC2	1SNA007865R2600	100	
7 Terminal block markers Blank card	White <input type="checkbox"/>	RC65	1SNA232000R0000	1	3.60

Complete list of accessories is indicated in the terminal block datasheet. Some accessories such as jumper bars may modify the terminal block's ratings: complete information in the accessories catalogue pages.

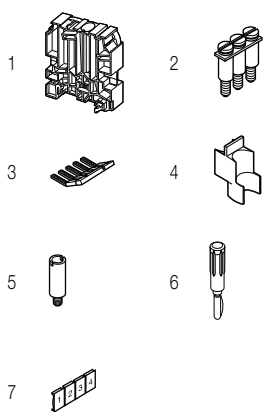

Ground screw clamp terminal blocks

Description	Color	Type	Order code	Pkg qty	Weight (1 pce) g
Ground Profile aligned with D4/6.T3...	Green-yellow <input type="checkbox"/>	D4/6.P.T1	1SNA199220R0000	25	

All the technical data for UL/CSA standard and dimensions in inches are in italic. Technical data valid for copper conductors only.

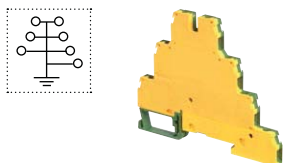

D4/6.T screw clamp terminal blocks

Triple deck - 6 mm 0.236 in spacing

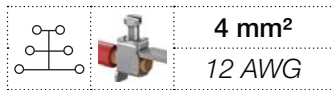

1 feed-through circuit

Ordering details

Description	Color	Type	Order code	Pkg qty	Weight (1 pce) g
Feed-through 1 feed-through circuit	Black ■	D4/6.T1	1SNA199219R0300	25	29.00

Main technical data	IEC	UL	CSA	Notes
Rated voltage	500 V	300 V		Can not be fitted with accessories : test sockets, test plugs and jumper bars BJM62
Impulse withstand voltage	6000 V			
Protection	IP20	NEMA 1		

CE	RoHS	UL	Gost R																
----	------	----	--------	--	--	--	--	--	--	--	--	--	--	--	--	--	--	--	--

Accessories

Description	Color	Type	Order code	Pkg qty	Weight (1 pce) g
1 Jumper bars 1 poles 24 A	Grey □	AD2.5	1SNA114205R2000	50	1.60

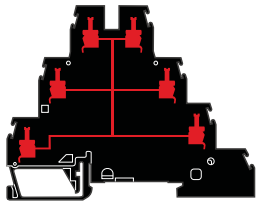

6 mm 0.236 in spacing



1

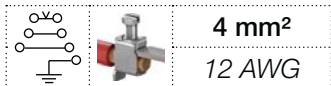

With ground, 3 feed-through circuit

Ordering details

Description	Color	Type	Order code	Pkg qty	Weight (1 pce) g
Feed-through + ground 3 feed-through circuits + 1 ground	Grey □	D4/6.T3.P	1SNA299684R0200	25	30.00

Main technical data	IEC	UL	CSA	Notes
Rated voltage	500 V	300 V		Nota
Impulse withstand voltage	6000 V			
Protection	IP20	NEMA 1		

CE	RoHS	UL	Gost R																
----	------	----	--------	--	--	--	--	--	--	--	--	--	--	--	--	--	--	--	--

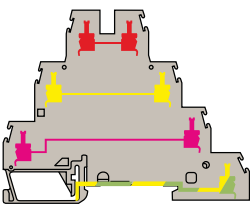

6 mm 0.236 in spacing

All the technical data for UL/CSA standard and dimensions in inches are in italic. Technical data valid for copper conductors only.

D4/6.P.T1 screw clamp terminal blocks

Ground - 6 mm 0.236 in spacing

2

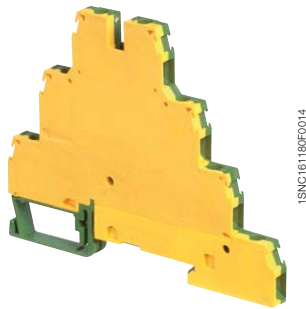

1SNC161186P0014

D4/6.P.T1

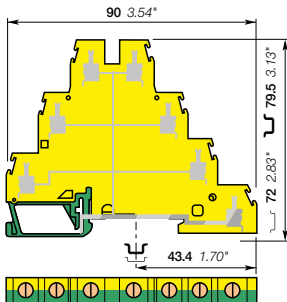

6 mm 0.236 in spacing

Description

- Reliable electrical and mechanical contact with rail,
- Ease ground distribution on 7 independent screw clamps.

Ordering details

Description	Color	Type	Order code	Pkg qty	Weight (1 pce) g
Ground Screwless rail connection	Green-yellow	D4/6.P.T1	1SNA199220R0000	25	

Main technical data

Connecting capacity		IEC	UL	CSA	Mounting instructions	
1 conductor per clamp	Rigid - Solid / Stranded	0.2-4 mm ²	22-12 AWG		Rail	G32, TH 35-7.5, TH 35-15
	Flexible with insulated ferrule	0.22-4 mm ²			Wire stripping length	9.5 mm 0.37 in
	Gauge	A4			Screw clamp Tool	Flat screwdriver Ø 4 mm Ø 0.16 in
Rated cross section		4 mm ²	12 AWG		Torque	0.5 - 0.8 N.m 4.4 - 7.1 lb.in
Rated short-time withstand current (1s)		480 A				

The connecting capacity data for one Rigid - Solid / Stranded - Flexible conductor (when applicable) is a mandatory information required by IEC, UL and CSA standards. All other data are provided as supplementary information only. For more details, please consult our CB, UL or CSA certificates and technical datasheet available on <http://www.abb.com>

--	--	--	--	--	--	--	--	--	--

Accessories

Description	Color	Type	Order code	Pkg qty	Weight (1 pce) g
1 End stops 12 mm	Grey	BADH	1SNA116900R2700	50	24.00
2 Jumper bars 1 poles 24 A	Grey	AD2.5	1SNA114205R2000	50	1.60
3 Lateral jumper bars 10 poles 35 A		PC61-10	1SNA163311R2200	10	5.00
4 Terminal block markers Blank card	White	RC65	1SNA232000R0000	1	3.60

Complete list of accessories is indicated in the terminal block datasheet. Some accessories such as jumper bars may modify the terminal block's ratings: complete information in the accessories catalogue pages.

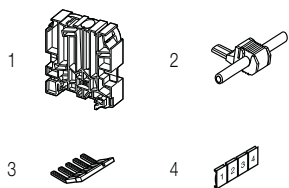

All the technical data for UL/CSA standard and dimensions in inches are in italic. Technical data valid for copper conductors only.

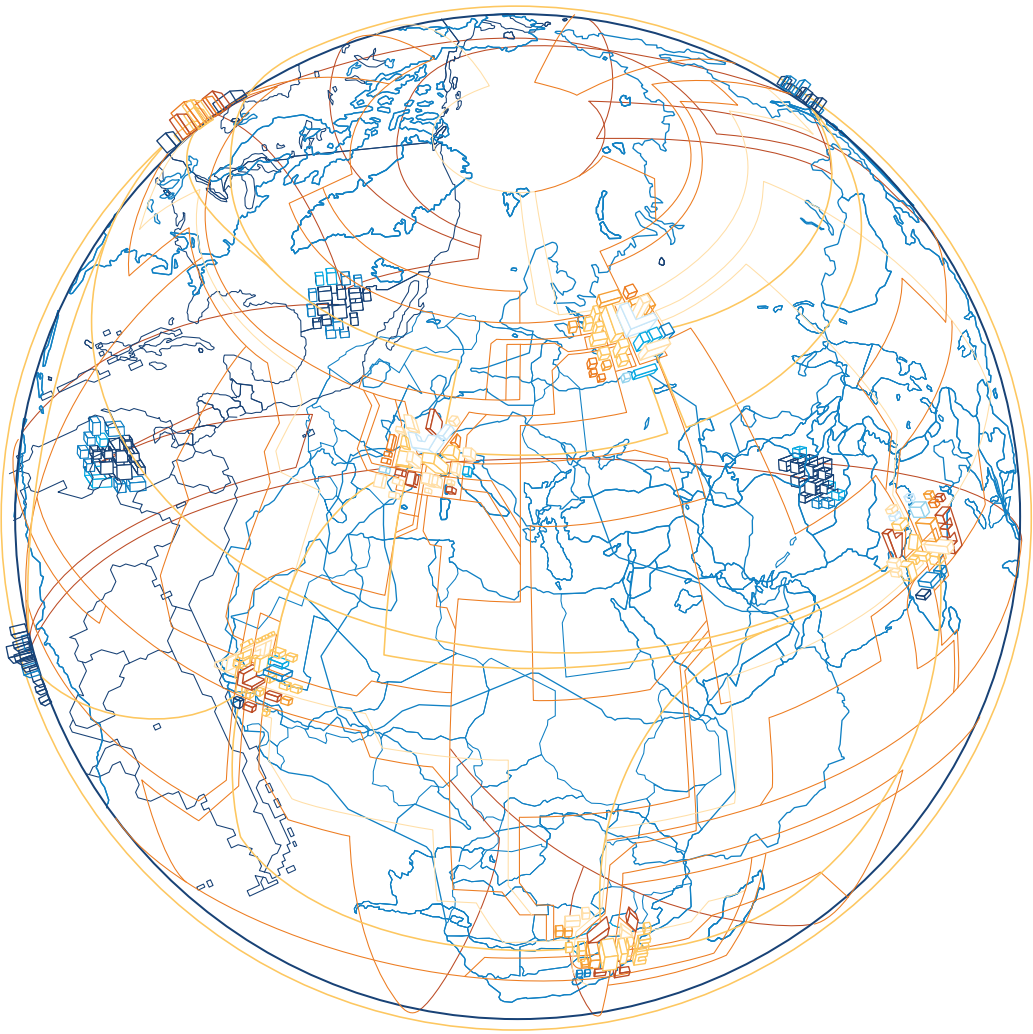

MA2.5/5.SNB screw clamp terminal blocks

Disconnect with blade - 5 mm 0.197 in spacing



2.5 mm²
12 AWG

2

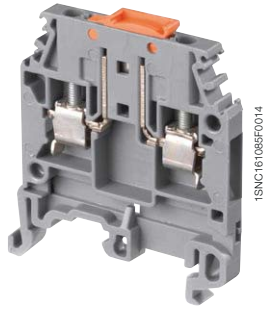

MA2.5/5.SNB

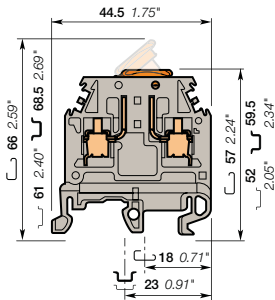

5 mm 0.197 in spacing

Description

- Ease your disconnect operations with the disconnect blade operated by hand or with screwdriver,
- Same profile as MA2.5/5 feed-through terminal block for aligned marking and identical end section use.

Ordering details

Description	Color	Type	Order code	Pkg qty	Weight (1 pce) g
Disconnect	Grey-orange	MA2.5/5.SNB	1SNA115699R2000	50	8.00

Main technical data

Connecting capacity		IEC	UL	CSA	Mounting instructions	
1 conductor per clamp	Rigid - Solid / Stranded	0.5-4 mm ²		28-12 AWG	Rail	G32, TH 35-7.5, TH 35-15
	Flexible with insulated ferrule	0.5-2.5 mm ²			Wire stripping length	10 mm 0.39 in
	Gauge	A3			Tool	Flat screwdriver Ø 3.5 mm Ø 0.138 in
Rated current / Rated cross section		10 A / 2.5 mm ²		15 A / 12 AWG	Torque	0.4 - 0.6 N.m 3.5 - 5.3 lb.in
Rated short-time withstand current (1s)		120 A				
Rated voltage		320 V		600 V		
Impulse withstand voltage		4000 V				
Protection		IP20	NEMA 1			

The connecting capacity data for one Rigid - Solid / Stranded - Flexible conductor (when applicable) is a mandatory information required by IEC, UL and CSA standards. All other data are provided as supplementary information only. For more details, please consult our CB, UL or CSA certificates and technical datasheet available on <http://www.abb.com>

CE	RoHS	cCSAus	Gost R
----	------	--------	--------

Accessories

Description	Color	Type	Order code	Pkg qty	Weight (1 pce) g
1 End stops	Grey	BAM2	1SNA206351R1600	50	12.00
		BADL	1SNA399903R0200	50	4.70
2 End sections	Grey	FEM6	1SNA118368R1600	20	2.40
3 Lateral jumper bars	Grey	PC5-2	1SNA113542R1000	10	1.80
		PC5-10	1SNA113544R1200	10	6.00
4 Circuit separators	Grey	SCFM6	1SNA114825R0500	20	4.00
		SCF6	1SNA118707R0300	20	
		CBM5	1SNA178745R1400	50	
5 Shield connectors					
6 Terminal block markers	White	RC510	1SNA231000R0700	1	5.20

Complete list of accessories is indicated in the terminal block datasheet. Some accessories such as jumper bars may modify the terminal block's ratings: complete information in the accessories catalogue pages.

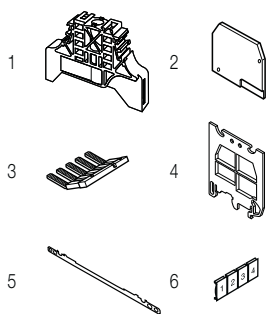

All the technical data for UL/CSA standard and dimensions in inches are in italic. Technical data valid for copper conductors only.

MA2.5/5.SNBT screw clamp terminal blocks

Disconnect with blade - with test socket

5 mm 0.197 in spacing



MA2.5/5.SNBT

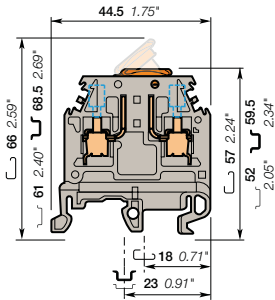

5 mm 0.197 in spacing

Description

- Ease your test operations with the two built-in test socket,
- Ease your disconnect operations with the disconnect blade operated by hand or with screwdriver,
- Same profile as MA2.5/5 feed-through terminal block for aligned marking and identical end section use.

Ordering details

Description	Color	Type	Order code	Pkg qty	Weight (1 pce) g
Disconnect	Grey-orange	MA2.5/5.SNBT	1SNA115700R0500	50	11.00
		MA2.5/5.SNBT	1SNA115701R2200	50	11.00
	Grey-grey	MA2.5/5.SNBTA	1SNA115505R1600	50	11.00
		Blue-grey	MA2.5/5.SNBTA	1SNA125505R1000	50

Main technical data

Connecting capacity	IEC	UL	CSA
1 conductor per clamp	Rigid - Solid / Stranded	0.5-4 mm ²	28-12 AWG
	Flexible with insulated ferrule	0.5-2.5 mm ²	
	Gauge	A3	
Rated current / Rated cross section	10 A / 2.5 mm ²		15 A / 12 AWG
Rated short-time withstand current (1s)	120 A		
Rated voltage	320 V		600 V
Impulse withstand voltage	4000 V		
Protection	IP10	NEMA	

Mounting instructions

Rail		G32, TH 35-7.5, TH 35-15
Wire stripping length		10 mm 0.39 in
Tool		Flat screwdriver Ø 3.5 mm Ø 0.138 in
Torque		0.4 - 0.6 N.m 3.5 - 5.3 lb.in

The connecting capacity data for one Rigid - Solid / Stranded - Flexible conductor (when applicable) is a mandatory information required by IEC, UL and CSA standards. All other data are provided as supplementary information only. For more details, please consult our CB, UL or CSA certificates and technical datasheet available on <http://www.abb.com>

CE	RoHS	cCSAus	Gost R
----	------	--------	--------

Accessories

Description	Color	Type	Order code	Pkg qty	Weight (1 pce) g
1 End stops	Grey	BAM2	1SNA206351R1600	50	12.00
		BADL	1SNA399903R0200	50	4.70
2 End sections	Grey	FEM6	1SNA118368R1600	20	2.40
3 Lateral jumper bars	Grey	PC5-2	1SNA113542R1000	10	1.80
		PC5-10	1SNA113544R1200	10	6.00
4 Circuit separators	Grey	SCFM6	1SNA114825R0500	20	4.00
		SCF6	1SNA118707R0300	20	
		FC2	1SNA007865R2600	100	
5 Test plugs	Black	FC2	1SNA007865R2600	100	
6 Shield connectors		CBM5	1SNA178745R1400	50	
7 Terminal block markers	White	RC510	1SNA231000R0700	1	5.20

Complete list of accessories is indicated in the terminal block datasheet. Some accessories such as jumper bars may modify the terminal block's ratings: complete information in the accessories catalogue pages.

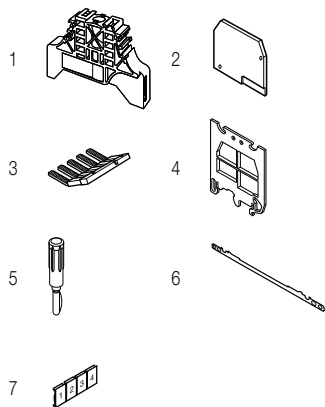

All the technical data for UL/CSA standard and dimensions in inches are in italic. Technical data valid for copper conductors only.

M4/6.SNB screw clamp terminal blocks

Disconnect with blade - 6 mm 0.236 in spacing



Description

- Ease your disconnect operations with the disconnect blade operated by hand or with screwdriver,
- Same profile as M4/6 feed-through terminal block for aligned marking.

Ordering details

Description	Color	Type	Order code	Pkg qty	Weight (1 pce) g
Disconnect	Grey, Orange	M4/6.SNB	1SNA115986R0000	50	11.00
	Orange, Orange	M4/6.SNB	1SNA105053R2200	50	11.00
	Grey, Grey	M4/6.SNB	1SNA115686R1300	50	11.00
	Beige, Grey	M4/6.SNB	1SNA195686R1400	50	11.00

Main technical data

Connecting capacity		IEC	UL	CSA	Mounting instructions	
1 conductor per clamp	Rigid - Solid / Stranded	0.5-4 mm ²	22-10 AWG	24-10 AWG	Rail	G32, TH 35-7.5, TH 35-15
	Flexible with insulated ferrule	0.5-4 mm ²			Wire stripping length	9.5 mm 0.37 in
	Gauge	A4			Tool	Flat screwdriver Ø 4 mm Ø 0.16 in
Rated current / Rated cross section		20 A / 4 mm ²	10 A / 10 AWG	15 A / 10 AWG	Torque	0.5 - 0.6 N.m 4.4 - 5.3 lb.in
Rated short-time withstand current (1s)		300 A				
Rated voltage		400 V	300 V	600 V		
Impulse withstand voltage		4000 V				
Protection		IP20	NEMA 1			

The connecting capacity data for one Rigid - Solid / Stranded - Flexible conductor (when applicable) is a mandatory information required by IEC, UL and CSA standards. All other data are provided as supplementary information only. For more details, please consult our CB, UL or CSA certificates and technical datasheet available on <http://www.abb.com>

CE	RoHS	USR	cCSAus	Gost R					
----	------	-----	--------	--------	--	--	--	--	--

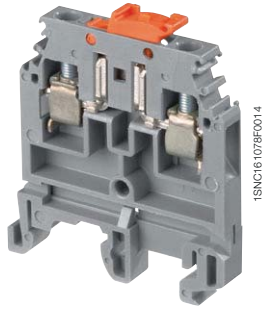

M4/6.SNB

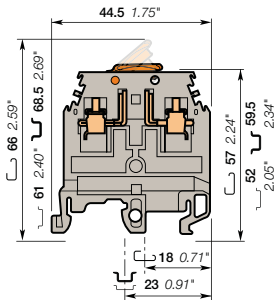

6 mm 0.236 in spacing

Accessories

Description	Color	Type	Order code	Pkg qty	Weight (1 pce) g
1 End stops	Grey	BAM2	1SNA206351R1600	50	12.00
		BADL	1SNA399903R0200	50	4.70
2 End sections	Grey	FEM62	1SNA114994R0700	20	2.40
3 Jumper bars	Grey	AD2.5	1SNA114205R2000	50	1.60
4 Lateral jumper bars		PC61-10	1SNA163311R2200	10	5.00
5 Circuit separators	Grey	SCFM6	1SNA114825R0500	20	4.00
6 Shield connectors		CBM5	1SNA178745R1400	50	
7 Terminal block markers	White	RC610	1SNA233000R0100	1	7.50

Complete list of accessories is indicated in the terminal block datasheet. Some accessories such as jumper bars may modify the terminal block's ratings: complete information in the accessories catalogue pages.



All the technical data for UL/CSA standard and dimensions in inches are in italic. Technical data valid for copper conductors only.

M4/6.SNBT screw clamp terminal blocks

Disconnect with blade - with test socket - 6 mm 0.236 in spacing

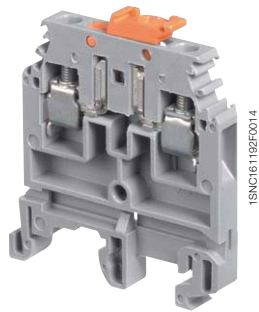

M4/6.SNBT

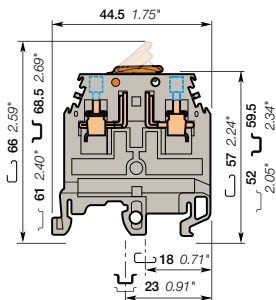

6 mm 0.236 in spacing

Description

- Ease your test operations with the two built-in test sockets,
- Ease your disconnect operations with the disconnect blade operated by hand or with a screwdriver,
- Same profile as M4/6 feed-through terminal block for aligned marking.

Ordering details

Description	Color	Type	Order code	Pkg qty	Weight (1 pce) g
Disconnect With 2 tests sockets DIA 2 mm 0.079 in	Grey, orange	M4/6.SNBT	1SNA115987R0100	50	11.00
	Grey, grey	M4/6.SNBT	1SNA115438R1200	50	11.00
	Beige, grey	M4/6.SNBT	1SNA195438R1300	50	11.00
With 2 tests sockets DIA 2.3 mm 0.091 in	Grey, orange	M4/6.SNBT	1SNA206538R0200	50	11.00
	Beige, orange	M4/6.SNBT	1SNA115495R0400	50	11.00

Main technical data

Connecting capacity	IEC	UL	CSA
1 conductor per clamp	Rigid - Solid / Stranded	0.5-4 mm ²	22-10 AWG
	Flexible with insulated ferrule	0.5-4 mm ²	24-10 AWG
	Gauge	A4	
Rated current / Rated cross section	20 A / 4 mm ²	10 A / 10 AWG	15 A / 10 AWG
Rated short-time withstand current (1s)	300 A		
Rated voltage	400 V	300 V	600 V
Impulse withstand voltage	4000 V		
Protection	IP20	NEMA 1	

Mounting instructions

Rail		G32, TH 35-7.5, TH 35-15
Wire stripping length		9.5 mm 0.374 in
Tool		Flat screwdriver Ø 4 mm Ø 0.157 in
Torque		0.5 - 0.6 N.m 4.4 - 5.3 lb.in

The connecting capacity data for one Rigid - Solid / Stranded - Flexible conductor (when applicable) is a mandatory information required by IEC, UL and CSA standards. All other data are provided as supplementary information only. For more details, please consult our CB, UL or CSA certificates and technical datasheet available on <http://www.abb.com>

CE	RoHS	UL	cCSAus	Gost R

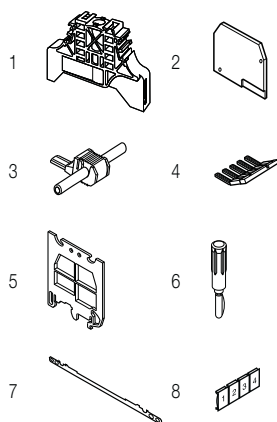

Accessories

Description	Color	Type	Order code	Pkg qty	Weight (1 pce) g
1 End stops	Grey	BAM2	1SNA206351R1600	50	12.00
		BADL	1SNA39903R0200	50	4.70
2 End sections	Grey	FEM62	1SNA114994R0700	20	2.40
3 Jumper bars	Grey	AD2.5	1SNA114205R2000	50	1.60
4 Lateral jumper bars		PC61-10	1SNA163311R2200	10	5.00
5 Circuit separators	Grey	SCFM6	1SNA114825R0500	20	4.00
6 Test plugs	Black	FC2	1SNA007865R2600	100	
7 Shield connectors		CBM5	1SNA178745R1400	50	
8 Terminal block markers	White	RC610	1SNA233000R0100	1	7.50

Complete list of accessories is indicated in the terminal block datasheet. Some accessories such as jumper bars may modify the terminal block's ratings: complete information in the accessories catalogue pages.

All the technical data for UL/CSA standard and dimensions in inches are in italic. Technical data valid for copper conductors only.

M6/8.SNB screw clamp terminal blocks

Disconnect with blade - 8 mm 0.315 in spacing



6 mm²
8 AWG

2

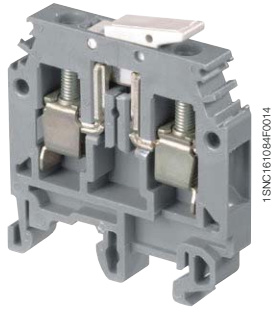

M6/8.SNB

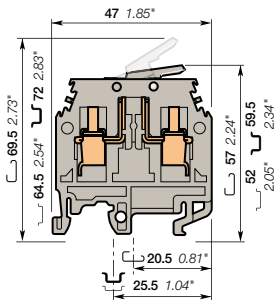

8 mm 0.315 in spacing

Description

- Ease your disconnect operations with the disconnect blade operated by hand or with screwdriver,
- Same profile as M6/8 feed-through terminal block for aligned marking.

Ordering details

Description	Color	Type	Order code	Pkg qty	Weight (1 pce) g
Disconnect	Grey, Grey	M6/8.SNB	1SNA115688R2500	50	19.00
	Orange, Orange	M6/8.SNB	1SNA105055R2400	50	19.00

Main technical data

Connecting capacity	IEC	UL	CSA
1 conductor per clamp	Rigid - Solid / Stranded	0.5-10 mm ²	22-8 AWG
	Flexible with insulated ferrule	0.5-6 mm ²	
	Gauge	A5	
Rated current / Rated cross section	15 A / 6 mm ²	20 A / 8 AWG	20 A / 8 AWG
Rated short-time withstand current (1s)	180 A		
Rated voltage	400 V	300 V	600 V
Impulse withstand voltage	4000 V		
Protection	IP20	NEMA 1	

Mounting instructions

Rail		G32, TH 35-7.5, TH 35-15
Wire stripping length		12 mm 0.47 in
Tool		Flat screwdriver Ø 4-5 mm Ø 0.16-0.20 in
Torque		0.8 - 1 N.m 7.1 - 8.9 lb.in

The connecting capacity data for one Rigid - Solid / Stranded - Flexible conductor (when applicable) is a mandatory information required by IEC, UL and CSA standards. All other data are provided as supplementary information only. For more details, please consult our CB, UL or CSA certificates and technical datasheet available on <http://www.abb.com>

CE	RoHS	USF	cCSAus	Gost R

Accessories

Description	Color	Type	Order code	Pkg qty	Weight (1 pce) g	
1 End stops	Grey	BAM2	1SNA206351R1600	50	12.00	
		BADL	1SNA399903R0200	50	4.70	
2 End sections	Grey	FEM8	1SNA113373R2600	20	3.00	
3 Jumper bars	Grey	AD2.5	1SNA114205R2000	50	1.60	
4 Lateral jumper bars		2 poles	PC8-2	1SNA116538R1700	10	3.00
		3 poles	PC8-3	1SNA116539R1000	10	4.00
		4 poles	PC8-4	1SNA116540R2500	10	6.00
		10 poles	PC8-10	1SNA163313R2400	10	
5 Circuit separators	Grey	SCFM6	1SNA114825R0500	20	4.00	
6 Test plugs	Black	FC2	1SNA007865R2600	100		
7 Terminal block markers	White	RC810	1SNA234000R0200	1	8.20	

Complete list of accessories is indicated in the terminal block datasheet. Some accessories such as jumper bars may modify the terminal block's ratings: complete information in the accessories catalogue pages.

All the technical data for UL/CSA standard and dimensions in inches are in italic. Technical data valid for copper conductors only.

M4/6.D2.SNBT screw clamp terminal blocks

Disconnect with blade - with test socket - 6 mm 0.236 in spacing



M4/6.D2.SNBT

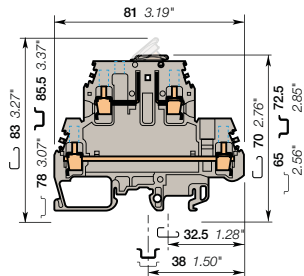

6 mm 0.236 in spacing

Description

- Save space with double deck terminal blocks: 1 disconnect circuit on top + 1 independent feed-through circuit on bottom in just 6 mm 0.236 in spacing,
- Ease your disconnect operations with the disconnect blade operated by hand or with screwdriver,
- Same profile as M4/6.D2 feed-through terminal block for aligned marking and identical end section use.

Ordering details

Description	Color	Type	Order code	Pkg qty	Weight (1 pce)
Disconnect With 4 tests sockets DIA 2 mm 0.079 in	Grey <input type="checkbox"/>	M4/6.D2.SNBT	1SNA115561R1500	50	21.00 g

Main technical data

Connecting capacity	IEC	UL	CSA
1 conductor per clamp	Rigid - Solid / Stranded Flexible with insulated ferrule Gauge	0.5-4 mm ² 0.5-4 mm ² A4	24-12 AWG 24-10 AWG
Rated current / Rated cross section	10 A / 4 mm ²	20 A / 12 AWG	15 A / 10 AWG
Rated short-time withstand current (1s)	120 A		
Rated voltage	400 V	300 V	600 V
Impulse withstand voltage	4000 V		
Protection	IP20	NEMA 1	

Mounting instructions

Rail		G32, TH 35-7.5, TH 35-15
Wire stripping length		9.5 mm 0.374 in
Tool		Flat screwdriver Ø 4 mm Ø 0.157 in
Torque		0.5 - 0.6 N.m 4.4 - 5.3 lb.in

The connecting capacity data for one Rigid - Solid / Stranded - Flexible conductor (when applicable) is a mandatory information required by IEC, UL and CSA standards. All other data are provided as supplementary information only, for more details, please consult our CB, UL or CSA certificates and technical datasheet available on <http://www.abb.com>

CE	RoHS	UL	CSA	Gost R

Accessories

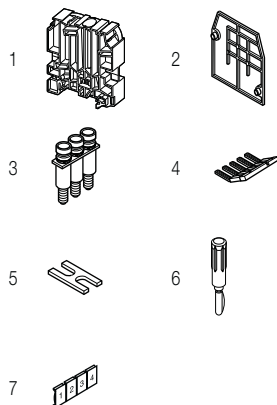

Description	Color	Type	Order code	Pkg qty	Weight (1 pce)
1 End stops 12 mm 0.472 in	Grey <input type="checkbox"/>	BADH	1SNA116900R2700	50	24.00
2 End sections 1 mm 0.039 in	Grey <input type="checkbox"/>	FEMS6D	1SNA116591R0500	20	3.70
3 Jumper bars 2 poles 32 A	Grey <input type="checkbox"/>	BJM6D-2	1SNA179668R2000	10	4.00
3 poles		BJM6D-3	1SNA179669R2100	10	6.00
4 poles		BJM6D-4	1SNA179670R2600	10	8.00
5 poles		BJM6D-5	1SNA179671R1300	10	10.00
10 poles		BJM6D-10	1SNA179672R1400	10	20.00
4 Lateral jumper bars 10 poles 35 A		PC61-10	1SNA163311R2200	10	5.00
5 Cross spacing jumpers 5 mm 0.200 in - 6 mm 0.236 in - 8 mm 0.315 in		EL6	1SNA173627R2100	10	0.10
6 Test plugs DIA 2 mm 0.079 in	Black <input type="checkbox"/>	FC2	1SNA007865R2600	100	7.50
7 Terminal block markers Blank card	White <input type="checkbox"/>	RC610	1SNA233000R0100	1	7.50

Complete list of accessories is indicated in the terminal block datasheet. Some accessories such as jumper bars may modify the terminal block's ratings: complete information in the accessories catalogue pages.

All the technical data for UL/CSA standard and dimensions in inches are in *italics*.
Technical data valid for copper conductors only.

M4/6.SB screw clamp terminal blocks

Disconnect with plug - 6 mm 0.236 in spacing



2

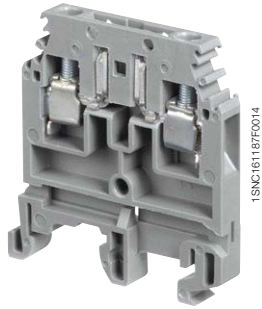

M4/6.SB

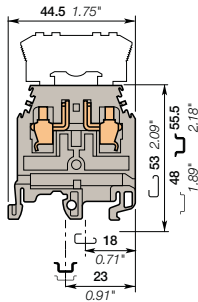

6 mm 0.236 in spacing

Description

- Ease your disconnect operations with the disconnect component holder plug,
- Same profile as M4/6 feed-through terminal block for aligned marking.

Ordering details

Description	Color	Type	Order code	Pkg qty	Weight (1 pce) g
Disconnect By polarized plug	Grey <input type="checkbox"/>	M4/6.SB	1SNA115435R0700	50	10.00

Main technical data

Connecting capacity	IEC	UL	CSA
1 conductor per clamp	Rigid - Solid / Stranded	0.5-4 mm ²	22-10 AWG
	Flexible	0.5-4 mm ²	24-10 AWG
	Flexible with insulated ferrule		
Gauge	A4		
Rated current / Rated cross section			
	10 A / 4 mm ²	10 A / 10 AWG	15 A / 10 AWG
Rated short-time withstand current (1s)			
	120 A		
Rated voltage			
	250 V	300 V	600 V
Impulse withstand voltage			
	4000 V		
Protection			
	IP20	NEMA 1	

Mounting instructions

Rail		G32, TH 35-7.5, TH 35-15
Wire stripping length		9.5 mm 0.374 in
Tool		Flat screwdriver Ø 4 mm Ø 0.157 in
Torque		0.5 - 0.8 N.m 4.4 - 7.1 lb.in

The connecting capacity data for one Rigid - Solid / Stranded - Flexible conductor (when applicable) is a mandatory information required by IEC, UL and CSA standards. All other data are provided as supplementary information only. For more details, please consult our CB, UL or CSA certificates and technical datasheet available on <http://www.abb.com>

CE	RoHS	RoHS	USR	cCSAus	Gost R
----	------	------	-----	--------	--------

Accessories

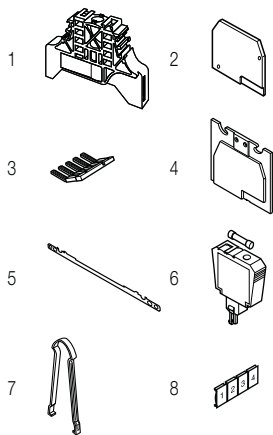

Description	Color	Type	Order code	Pkg qty	Weight (1 pce) g
1 End stops	Grey <input type="checkbox"/>	BAM2	1SNA206351R1600	50	12.00
		BADL	1SNA399903R0200	50	4.70
2 End sections	Grey <input type="checkbox"/>	FEM62	1SNA114994R0700	20	2.40
3 Lateral jumper bars		PC61-10	1SNA163311R2200	10	5.00
4 Circuit separators	Grey <input type="checkbox"/>	SCF6	1SNA118707R0300	20	
5 Shield connectors		CBM5	1SNA178745R1400	50	
6 Component plugs	Beige <input type="checkbox"/>	BNSV62	1SNA196854R1500	50	6.00
		BNF652-D1-BE	1SNA196966R1500	50	7.00
		BNF652L-BE	1SNA196967R1600	50	7.00
		BNF652	1SNA196998R1600	50	6.00
		BNF652D-BE	1SNA196999R1700	50	7.00
		BFAUTO	1SNA293486R2400	50	1.00
7 Extraction tools	Black <input type="checkbox"/>	BNS6DG1	1SNA400146R0000	1	6.00
		EXBN2	1SNA171018R2000	1	
8 Terminal block markers	White <input type="checkbox"/>	RC610	1SNA233000R0100	1	7.50

Complete list of accessories is indicated in the terminal block datasheet.

Some accessories such as jumper bars may modify the terminal block's ratings: complete information in the accessories catalogue pages.

All the technical data for UL/CSA standard and dimensions in inches are in italic.
Technical data valid for copper conductors only.

M6/8.SB screw clamp terminal blocks

Disconnect with plug - 8 mm 0.315 in spacing

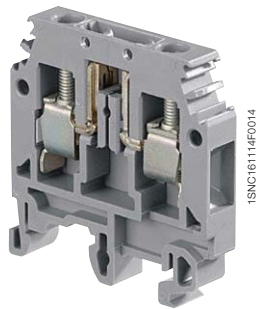

M6/8.SB

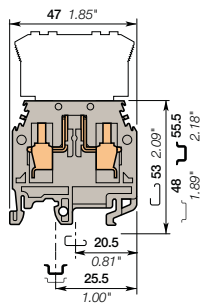

8 mm 0.315 in spacing

Description

- Ease your disconnect operations with the disconnect component holder plug,
- Same profile as M6/8 feed-through terminal block for aligned marking.

Ordering details

Description	Color	Type	Order code	Pkg qty	Weight (1 pce) g
Disconnect By polarized plug	Grey <input type="checkbox"/>	M6/8.SB	1SNA115436R0000	50	17.00

Main technical data

Connecting capacity		IEC	UL	CSA	Mounting instructions	
1 conductor per clamp	Rigid - Solid / Stranded	0.5-10 mm ²	22-8 AWG	22-8 AWG	Rail	G32, TH 35-7.5, TH 35-15
	Flexible with insulated ferrule	0.5-6 mm ²			Wire stripping length	12 mm 0.472 in
	Gauge	A5			Tool	Flat screwdriver Ø 4 - 5 mm Ø 0.157 - 0.197 in
Rated current / Rated cross section		15 A / 6 mm ²	20 A / 8 AWG	20 A / 8 AWG	Torque	0.8 - 1 N.m 7.1 - 8.9 lb.in
Rated short-time withstand current (1s)		180 A				
Rated voltage		400 V	300 V	600 V		
Impulse withstand voltage		4000 V				
Protection		IP20	NEMA 1			

The connecting capacity data for one Rigid - Solid / Stranded - Flexible conductor (when applicable) is a mandatory information required by IEC, UL and CSA standards. All other data are provided as supplementary information only. For more details, please consult our CB, UL or CSA certificates and technical datasheet available on <http://www.abb.com>

--	--	--	--	--	--	--	--	--	--

Accessories

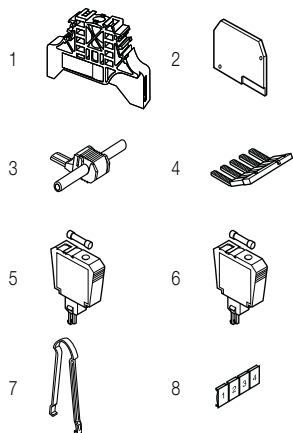

Description	Color	Type	Order code	Pkg qty	Weight (1 pce) g
1 End stops	Grey <input type="checkbox"/>	BAM2	1SNA206351R1600	50	12.00
		BADL	1SNA399903R0200	50	4.70
2 End sections	Grey <input type="checkbox"/>	FEM8	1SNA113373R2600	20	3.00
3 Jumper bars	Grey <input type="checkbox"/>	AD2.5	1SNA114205R2000	50	1.60
4 Lateral jumper bars		PC8-10	1SNA163313R2400	10	14.00
5 Component plugs	Orange <input type="checkbox"/>	BNF52	1SNA105133R1700	50	8.00
		BNF52	1SNA116924R0200	50	8.00
		BNSV82	1SNA116927R0500	50	8.00
		BNF52	1SNA196924R0300	50	8.00
		BNSV82	1SNA196927R0600	50	8.00
6 Short circuit plugs	Grey <input type="checkbox"/>	BNCT82	1SNA116926R0400	50	9.00
		BNCT82	1SNA196926R0500	50	9.00
7 Extraction tools		EXBN2	1SNA171018R2000	1	
8 Terminal block markers	White <input type="checkbox"/>	RC810	1SNA234000R0200	1	8.20

Complete list of accessories is indicated in the terminal block datasheet. Some accessories such as jumper bars may modify the terminal block's ratings: complete information in the accessories catalogue pages.

All the technical data for UL/CSA standard and dimensions in inches are in italic. Technical data valid for copper conductors only.

M4/6.D2.SB screw clamp terminal blocks

Disconnect with plug - with test socket - 6 mm 0.236 in spacing



4 mm²

2



1SNC16164F0014

M4/6.D2.SB

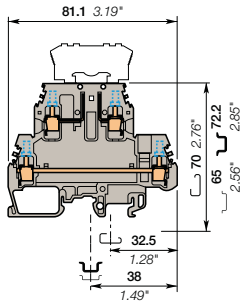

6 mm 0.236 in spacing

Description

- Save space with double deck terminal blocks: 1 disconnect circuit on top + 1 independent feed-through circuit on bottom in just 6 mm 0.236 in spacing,
- Ease your disconnect operations with the disconnect component holder plug.

Ordering details

Description	Color	Type	Order code	Pkg qty	Weight (1 pce)
Disconnect By polarized plug with 4 test sockets DIA 2 mm 0.079 in - 1 feed-through circuit on lower deck	Grey <input type="checkbox"/>	M4/6.D2.SBT	1SNA115702R2300	50	21.00

Main technical data

Connecting capacity	IEC	UL	CSA	Rail	G32. TH 35-7.5. TH 35-15
1 conductor per clamp	Rigid - Solid / Stranded Flexible with insulated ferrule Gauge	0.5-4 mm ² 0.5-4 mm ² A4		Wire stripping length	9.5 mm 0.374 in
				Tool	Flat screwdriver Ø 4 mm Ø 0.157 in
Rated current / Rated cross section		10 A / 4 mm ²		Torque	0.5 - 0.6 N.m 4.4 - 5.3 lb.in
Rated short-time withstand current (1s)		120 A			
Rated voltage		250 V			
Impulse withstand voltage		4000 V			
Protection		IP20	NEMA 1		

The connecting capacity data for one Rigid - Solid / Stranded - Flexible conductor (when applicable) is a mandatory information required by IEC, UL and CSA standards. All other data are provided as supplementary information only. For more details, please consult our CB, UL or CSA certificates and technical datasheet available on <http://www.abb.com>

CE	RoHS	Gost R
----	------	--------

Accessories

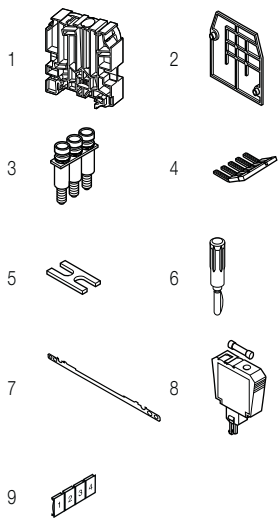

Description	Color	Type	Order code	Pkg qty	Weight (1 pce)
1 End stops 12 mm 0.472 in	Grey <input type="checkbox"/>	BADH	1SNA116900R2700	50	24.00
2 End sections 1 mm 0.039 in	Grey <input type="checkbox"/>	FEMS6D	1SNA116591R0500	20	3.70
3 Jumper bars 2 poles 32 A		BJMI6D-2	1SNA179668R2000	10	4.00
3 poles		BJMI6D-3	1SNA179669R2100	10	6.00
4 poles		BJMI6D-4	1SNA179670R2600	10	8.00
5 poles		BJMI6D-5	1SNA179671R1300	10	10.00
10 poles		BJMI6D-10	1SNA179672R1400	10	20.00
4 Lateral jumper bars 10 poles 35 A		PC61-10	1SNA163311R2200	10	5.00
5 Cross spacing jumpers 5 mm 0.200 in - 6 mm 0.236 in - 8 mm 0.315 in		EL6	1SNA173627R2100	10	0.10
6 Test plugs DIA 2 mm 0.079 in	Black <input type="checkbox"/>	FC2	1SNA007865R2600	100	
7 Shield connectors		CBD2S	1SNA178408R1400	50	
8 Component plugs With solder leads and screws	Grey <input type="checkbox"/>	BNSV62	1SNA116854R1400	50	6.00
	Beige <input type="checkbox"/>	BNSV62	1SNA196854R1500	50	6.00
With 48V blown fuse indicator	Beige <input type="checkbox"/>	BNF652-D1-BE	1SNA196966R1500	50	7.00
With 110-230V blown fuse indicator		BNF652L-BE	1SNA196967R1600	50	7.00
For 5x20 fuses		BNF652	1SNA196998R1600	50	6.00
With 24V blown fuse indicator		BNF652D-BE	1SNA196999R1700	50	7.00
For FUAUTO fuses	Black <input type="checkbox"/>	BFAUTO	1SNA299486R2400	50	1.00
9 Terminal block markers Blank card	White <input type="checkbox"/>	RC610	1SNA233000R0100	1	7.50

Complete list of accessories is indicated in the terminal block datasheet.

Some accessories such as jumper bars may modify the terminal block's ratings: complete information in the accessories catalogue pages.

All the technical data for UL/CSA standard and dimensions in inches are in *italics*.
Technical data valid for copper conductors only.

M6/8.STP screw clamp terminal blocks

Disconnect with push-turn knob - with test socket

8 mm 0.315 in spacing



M6/8.STP

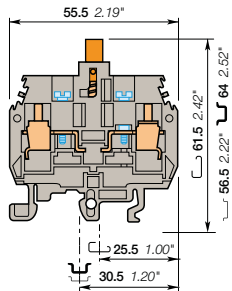

8 mm 0.315 in spacing

Description

- Ease your disconnect operations with the disconnect 1/4 turn push-turn knob,
- Possibility to seal in the open and closed position,
- Ease your test operations with the built-in test socket.

Ordering details

Description	Color	Type	Order code	Pkg qty	Weight (1 pce) g
Disconnect With 2 test sockets DIA 4 mm 0.157 in	Grey, orange	M6/8.STP1	1SNA115529R1500	25	21.00

Main technical data

Connecting capacity	IEC	UL	CSA	Rail	Wire stripping length	Tool	Torque
1 conductor per clamp	Rigid - Solid / Stranded Flexible with insulated ferrule Gauge	0.5-10 mm ² 0.5-6 mm ²		8 AWG	11 mm 0.433 in	Flat screwdriver Ø 4 mm Ø 0.157 in	0.8 - 1 N.m 7.1 - 8.9 lb.in
Rated current / Rated cross section	15 A / 6 mm ²		15 A / 8 AWG				
Rated short-time withstand current (1s)	720 A						
Rated voltage	500 V		600 V				
Impulse withstand voltage							
Protection	IP10	NEMA					

Mounting instructions

The connecting capacity data for one Rigid - Solid / Stranded - Flexible conductor (when applicable) is a mandatory information required by IEC, UL and CSA standards. All other data are provided as supplementary information only. For more details, please consult our CB, UL or CSA certificates and technical datasheet available on <http://www.abb.com>

RoHS	CSA	Gost R
RoHS	CSA	Gost R

Notes

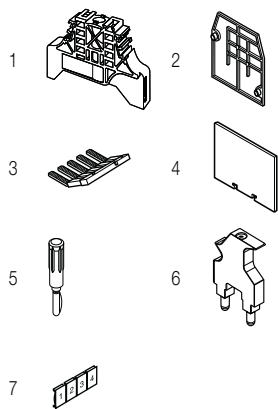
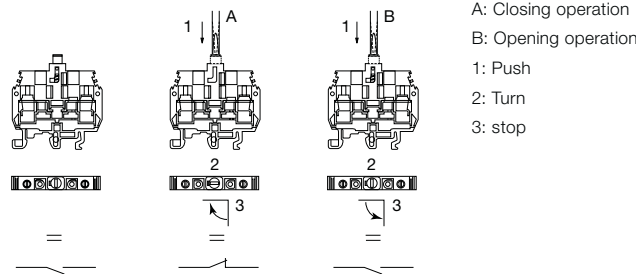

Accessories

Description	Color	Type	Order code	Pkg qty	Weight (1 pce) g
1 End stops	Grey	BAM2	1SNA206351R1600	50	12.00
		BADL	1SNA399903R0200	50	4.70
2 End sections	Grey	FEMT1	1SNA113137R0200	50	2.00
3 Lateral jumper bars		PC8-2	1SNA116538R1700	10	3.00
		PC8-3	1SNA116539R1000	10	4.00
		PC8-4	1SNA116540R2500	10	6.00
		PC8-10	1SNA163313R2400	10	14.00
4 Circuit separators	Grey	SCFT1	1SNA103588R2600	20	20.00
5 Test plugs	White	FC4	1SNA167860R0100	10	10.00
	Red	FC4-1	1SNA167927R1000	10	11.00
6 Short circuit plugs	Red	BP8.A4	1SNA173888R2000	10	10.00
	Red	BNSTP2	1SNA196789R2400	20	10.00
	Beige	BNSTP1	1SNA196792R1700	20	14.00
	White	RC810	1SNA234000R0200	1	8.20
7 Terminal block markers		Blank card			

Complete list of accessories is indicated in the terminal block datasheet. Some accessories such as jumper bars may modify the terminal block's ratings: complete information in the accessories catalogue pages.

Feed-through screw clamp terminal blocks

Description	Color	Type	Order code	Pkg qty	Weight (1 pce) g
Feed-through Profile aligned with M6/8 STP...	Grey	M6/8.STP3	1SNA115500R2500	25	21.00

All the technical data for UL/CSA standard and dimensions in inches are in *italics*. Technical data valid for copper conductors only.

M6/8.STP screw clamp terminal blocks

Disconnect with push-turn knob - with test socket

8 mm 0.315 in spacing



6 mm²
8 AWG

2



M6/8.STP

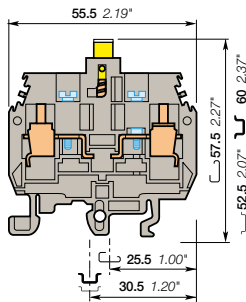

8 mm 0.315 in spacing

Description

- Ease your disconnect operations with the disconnect 1/4 turn push-turn knob,
- Possibility to seal in the open position,
- Ease your test operations with the built-in test socket.

Ordering details

Description	Color	Type	Order code	Pkg qty	Weight (1 pce) g
Disconnect With 2 test sockets DIA 4 mm 0.157 in	Grey, yellow	M6/8.STP	1SNA115277R2000	25	21.00
	Grey, black	M6/8.STP	1SNA105141R2700	25	21.00
	Grey, red	M6/8.STP	1SNA105142R2000	25	21.00

Main technical data

Connecting capacity	IEC	UL	CSA	Mounting instructions
1 conductor per clamp	Rigid - Solid / Stranded Flexible with insulated ferrule Gauge	0.5-10 mm ² 0.5-6 mm ²	22-8 AWG	8 AWG
Rated current / Rated cross section	15 A / 6 mm ²	40 A / 8 AWG	15 A / 8 AWG	
Rated short-time withstand current (1s)	180 A			
Rated voltage	500 V	600 V	600 V	
Impulse withstand voltage				
Protection	IP10	NEMA		

The connecting capacity data for one Rigid - Solid / Stranded - Flexible conductor (when applicable) is a mandatory information required by IEC, UL and CSA standards. All other data are provided as supplementary information only. For more details, please consult our CB, UL or CSA certificates and technical datasheet available on <http://www.abb.com>



Notes

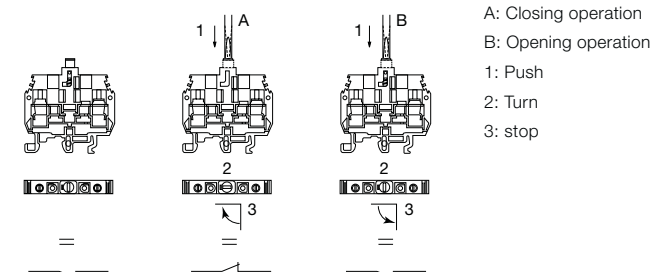

Accessories

Description	Color	Type	Order code	Pkg qty	Weight (1 pce) g
1 End stops	Grey	BAM2	1SNA206351R1600	50	12.00
		BADL	1SNA399903R0200	50	4.70
2 End sections	Grey	FEMT1	1SNA113137R0200	50	2.00
3 Lateral jumper bars		PC8-2	1SNA116538R1700	10	3.00
		PC8-3	1SNA116539R1000	10	4.00
		PC8-4	1SNA116540R2500	10	6.00
		PC8-10	1SNA163313R2400	10	14.00
4 Circuit separators	Grey	SCFT1	1SNA103588R2600	20	20.00
5 Test plugs	White	FC4	1SNA167860R0100	10	10.00
	Red	FC4-1	1SNA167927R1000	10	11.00
6 Short circuit plugs		BP8.A4	1SNA173888R2000	10	
	Red	BNSTP2	1SNA196789R2400	20	10.00
	Beige	BNSTP1	1SNA196792R1700	20	14.00
7 Terminal block markers	White	RC810	1SNA234000R0200	1	8.20

Complete list of accessories is indicated in the terminal block datasheet. Some accessories such as jumper bars may modify the terminal block's ratings: complete information in the accessories catalogue pages.

Feed-through screw clamp terminal blocks

Description	Color	Type	Order code	Pkg qty	Weight (1 pce) g
Feed-through Profile aligned with M6/8 STP...	Grey	M6/8.STP3	1SNA115500R2500	25	21.00

All the technical data for UL/CSA standard and dimensions in inches are in italic. Technical data valid for copper conductors only.

M6/8.STP screw clamp terminal blocks

Feed-through - 8 mm 0.315 in spacing

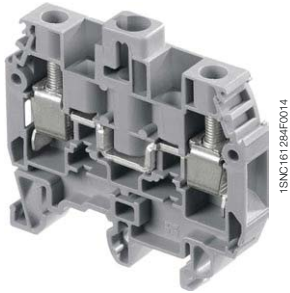

M6/8.STP

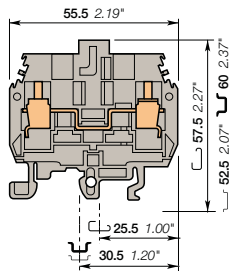

8 mm 0.315 in spacing

Description

- Simplify the alternated feed-through and disconnect circuits operations with the same profile as M6/8 STP...
- The wiring of the alternated feed-through and disconnect circuits is easier.

Ordering details

Description	Color	Type	Order code	Pkg qty	Weight (1 pce) g
Feed-through	Grey <input type="checkbox"/>	M6/8.STP3	1SNA115500R2500	25	21.00

Main technical data

Connecting capacity		IEC	UL	CSA	Mounting instructions	
1 conductor per clamp	Rigid - Solid / Stranded	0.5-10 mm ²	22-8 AWG	8 AWG	Rail	G32, TH 35-7.5, TH 35-15
	Flexible with insulated ferrule	0.5-6 mm ²			Wire stripping length	11 mm 0.433 in
	Gauge				Tool	Flat screwdriver Ø 4 mm Ø 0.157 in
Rated current / Rated cross section		41 A / 6 mm ²	40 A / 8 AWG	15 A / 8 AWG		
Rated short-time withstand current (1s)		720 A				
Rated voltage		500 V	600 V	600 V		
Impulse withstand voltage						
Protection		IP20	NEMA 1		Torque 0.8 - 1 N.m 7.1 - 8.9 lb.in	

The connecting capacity data for one Rigid - Solid / Stranded - Flexible conductor (when applicable) is a mandatory information required by IEC, UL and CSA standards. All other data are provided as supplementary information only. For more details, please consult our CB, UL or CSA certificates and technical datasheet available on <http://www.abb.com>



Accessories

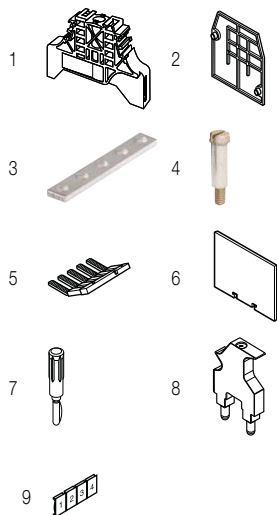

Description	Color	Type	Order code	Pkg qty	Weight (1 pce) g	
1 End stops	Grey <input type="checkbox"/>	10 mm 0.394 in	BAM2	1SNA206351R1600	50 12.00	
		9 mm 0.354 in	BADL	1SNA399903R0200	50 4.70	
2 End sections	Grey <input type="checkbox"/>	2.8 mm 0.110 in	FEMT1	1SNA113137R0200	50 2.00	
		2 poles	BJS8	1SNA164581R1300	10 3.10	
		3 poles		1SNA164582R1400	10 3.10	
		4 poles		1SNA164583R1500	10 3.10	
3 Jumper bars		41 A				
		20 poles	BJS8-20	1SNA174789R0500	5 3.20	
		Sub assembly post + screw + washer	EV6I	1SNA206394R0200	20 2.00	
4 Fastening kits		2 poles	PC8-2	1SNA116538R1700	10 3.00	
		3 poles	PC8-3	1SNA116539R1000	10 4.00	
		4 poles	PC8-4	1SNA116540R2500	10 6.00	
		10 poles	PC8-10	1SNA163313R2400	10 14.00	
		1 mm 0.039 in	Grey <input type="checkbox"/>	SCFT1	1SNA103588R2600	20 20.00
5 Lateral jumper bars		2 poles	PC8-2	1SNA116538R1700	10 3.00	
		3 poles	PC8-3	1SNA116539R1000	10 4.00	
		4 poles	PC8-4	1SNA116540R2500	10 6.00	
6 Circuit separators	Grey <input type="checkbox"/>	1 mm 0.039 in	SCFT1	1SNA103588R2600	20 20.00	
		DIA 4 mm 0.157 in	White <input type="checkbox"/>	FC4	1SNA167860R0100	10 10.00
7 Test plugs	Red <input type="checkbox"/>	DIA 4 mm 0.157 in IP20	FC4-1	1SNA167927R1000	10 11.00	
		DIA 4 mm 0.157 in	BP8.A4	1SNA173888R2000	10 10.00	
8 Short circuit plugs	Red <input type="checkbox"/>	With test DIA 4 mm 0.157 in	BNSTP2	1SNA196789R2400	20 10.00	
			Beige <input type="checkbox"/>	BNSTP1	1SNA196792R1700	20 14.00
			White <input type="checkbox"/>	RC810	1SNA234000R0200	1 8.20
9 Terminal block markers	White <input type="checkbox"/>	Blank card				

Complete list of accessories is indicated in the terminal block datasheet. Some accessories such as jumper bars may modify the terminal block's ratings: complete information in the accessories catalogue pages.

All the technical data for UL/CSA standard and dimensions in inches are in italic. Technical data valid for copper conductors only.

M6/8.ST screw clamp terminal blocks

Test disconnect with a screwdriver sliding link

8 mm 0.315 in spacing



2

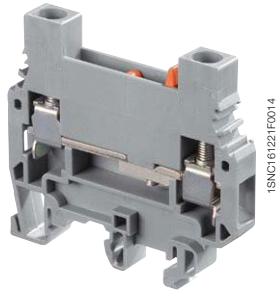

M6/8.ST

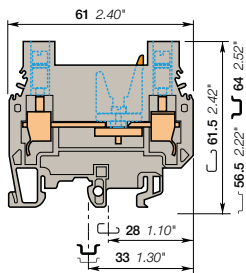

8 mm 0.315 in spacing

Description

Compact disconnect terminal blocks:

- Secure your disconnect operations with the disconnect orange sliding link operated with a screwdriver,
- Ease your test operations with the two built-in test sockets screws compatible with DIA 4 mm 0.157 in test plugs.

Ordering details

Description	Color	Type	Order code	Pkg qty	Weight (1 pce)
Disconnect With 2 test sockets DIA 4 mm 0.157 in	Grey <input type="checkbox"/>	M6/8.STA	1SNA115359R0200	25	30.00

Main technical data

Connecting capacity	IEC	UL	CSA	Mounting instructions	
1 conductor per clamp	Rigid - Solid / Stranded Flexible with insulated ferrule Gauge	0.5-10 mm ² 0.5-6 mm ² A5	22 - 8 AWG	Rail	G32, TH 35-7.5, TH 35-15
				Wire stripping length	11 mm 0.43 in
				Screw clamp Tool	Flat screwdriver Ø 5.5 mm Ø 0.217 in
				Torque	0.8 - 1 N.m 7.1 - 8.9 lb.in
Rated current / Rated cross section	30 A / 6 mm ²	50 A / 8 AWG		Disconnect device Tool	Flat screwdriver Ø 4 mm Ø 0.157 in
Rated short-time withstand current (1s)	480 A			Torque	0.4 - 0.6 N.m 3.5 - 5.3 lb.in
Rated voltage	500 V	600 V			
Impulse withstand voltage					
Protection	IP20	NEMA 1			

The connecting capacity data for one Rigid - Solid / Stranded - Flexible conductor (when applicable) is a mandatory information required by IEC, UL and CSA standards. All other data are provided as supplementary information only. For more details, please consult our CB, UL or CSA certificates and technical datasheet available on <http://www.abb.com>

--	--	--	--	--	--	--	--	--	--

Accessories

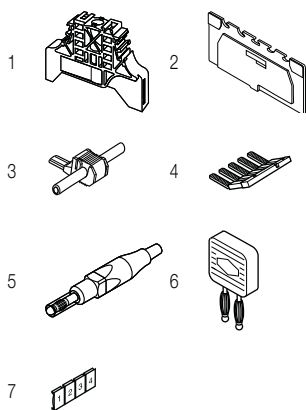

Description	Color	Type	Order code	Pkg qty	Weight (1 pce)
1 End stops	Grey <input type="checkbox"/>	BAM2	1SNA206351R1600	50	12.00
		BADL	1SNA399903R0200	50	4.70
2 End sections	Grey <input type="checkbox"/>	FEMT4	1SNA114778R0500	10	5.60
		FEMSTA	1SNA116979R2100	10	3.60
3 Jumper bars	Grey <input type="checkbox"/>	AD2.5	1SNA114205R2000	50	1.60
4 Lateral jumper bars	Black <input type="checkbox"/>	PC8-2	1SNA116538R1700	10	3.00
		PC8-3	1SNA116539R1000	10	4.00
		PC8-4	1SNA116540R2500	10	6.00
		PC8-10	1SNA163313R2400	10	14.00
5 Test plugs	Red <input type="checkbox"/>	FC4-1	1SNA167927R1000	10	11.00
6 Short circuit plugs		BP8.A4	1SNA173888R2000	10	
7 Terminal block markers	White <input type="checkbox"/>	RC810	1SNA234000R0200	1	8.20

Complete list of accessories is indicated in the terminal block datasheet. Some accessories such as jumper bars may modify the terminal block's ratings: complete information in the accessories catalogue pages.

All the technical data for UL/CSA standard and dimensions in inches are in italic. Technical data valid for copper conductors only.

M6/8.ST screw clamp terminal blocks

Test disconnect with a screwdriver sliding link

8 mm 0.315 in spacing



M6/8.ST

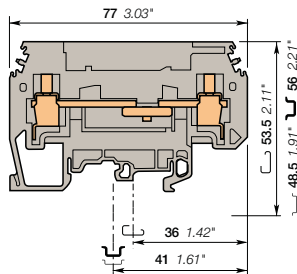

8 mm 0.315 in spacing

Description

Secure your disconnect operations with the disconnect sliding link operated with a screwdriver.

Ordering details

Description	Color	Type	Order code	Pkg qty	Weight (1 pce) g
Disconnect	Grey <input type="checkbox"/>	M6/8.ST	1SNA115236R1700	25	30.00

Main technical data

Connecting capacity		IEC	UL	CSA	Mounting instructions	
1 conductor per clamp	Rigid - Solid / Stranded	0.5-10 mm ²	18 - 8 AWG	18-8 AWG	Rail	G32, TH 35-7.5, TH 35-15
	Flexible with insulated ferrule	0.5-6 mm ²			Wire stripping length	13 mm 0.51 in
	Gauge	A5			Screw clamp Tool	Flat screwdriver Ø 5 mm Ø 0.197 in 0.8 - 1 N.m 7.1 - 8.9 lb.in
Rated current / Rated cross section		40 A / 6 mm ²	30 A / 8 AWG	30 A / 8 AWG	Torque	0.8 - 1 N.m 7.1 - 8.9 lb.in
Rated short-time withstand current (1s)		720 A			Disconnect device Tool	Flat screwdriver Ø 3.5 mm Ø 0.138 in
Rated voltage		630 V	150 V	150 V	Torque	0.4 - 0.6 N.m 3.5 - 5.3 lb.in
Impulse withstand voltage						
Protection		IP20	NEMA 1			

The connecting capacity data for one Rigid - Solid / Stranded - Flexible conductor (when applicable) is a mandatory information required by IEC, UL and CSA standards. All other data are provided as supplementary information only. For more details, please consult our CB, UL or CSA certificates and technical datasheet available on <http://www.abb.com>

CE	RoHS	UL	CSA	Gost R
----	------	----	-----	--------

Accessories

Description	Color	Type	Order code	Pkg qty	Weight (1 pce) g
1 End stops	Grey <input type="checkbox"/>	BAM2	1SNA206351R1600	50	12.00
		BADL	1SNA399903R0200	50	4.70
2 End sections	Grey <input type="checkbox"/>	FEMT2	1SNA113629R2700	10	2.00
3 Jumper bars		BJS8-20	1SNA174789R0500	5	3.20
4 Fastening kits		EV8S	1SNA168401R0300	20	3.00
5 Lateral jumper bars 50 A	Black <input type="checkbox"/>	PC8-10	1SNA163313R2400	10	14.00
		PC8-R1	1SNA400711R0600	10	6.60
		PC8-R2	1SNA400712R0700	10	7.84
		PC8-R3	1SNA400713R0000	10	9.00
		PC8-R4	1SNA400724R0300	10	4.50
6 Circuit separators	Grey <input type="checkbox"/>	SCFT2	1SNA114522R0500	20	
7 Test sockets	Yellow <input type="checkbox"/>	AJS9	1SNA179726R0200	25	5.00
	Black <input type="checkbox"/>	AJS9-1	1SNA206680R1500	25	3.60
	Green <input type="checkbox"/>	AJS9-2	1SNA206681R0200	25	3.60
	Grey <input type="checkbox"/>	AJS9-3	1SNA206682R0300	25	3.60
	Blue <input type="checkbox"/>	AJS9-4	1SNA206683R0400	25	3.60
	Red <input type="checkbox"/>	AJS9-5	1SNA206720R1400	25	3.60
		AL4-M3	1SNA206721R0100	50	1.10
8 Test plugs	Red <input type="checkbox"/>	FC4-1	1SNA167927R1000	10	11.00
9 Short circuit bridges	Yellow <input type="checkbox"/>	SC-JB8-2	1SNK900652R0000	25	2.00
		SC-JB8-3	1SNK900653R0000	25	3.40
		SC-JB8-4	1SNK900654R0000	25	4.70

Complete list of accessories is indicated in the terminal block datasheet. Some accessories such as jumper bars may modify the terminal block's ratings: complete information in the accessories catalogue pages.

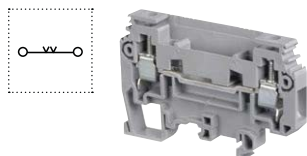

Feed-through screw clamp terminal blocks

Description	Color	Type	Order code	Pkg qty	Weight (1 pce) g
Feed-through Profile aligned with M6/8.ST...	Grey <input type="checkbox"/>	M6/8.ST7	1SNA115243R2600	25	20.00

All the technical data for UL/CSA standard and dimensions in inches are in *italics*. Technical data valid for copper conductors only.

M6/8.ST screw clamp terminal blocks

Test disconnect with a screwdriver sliding link

8 mm 0.315 in spacing



6 mm²
8 AWG

2

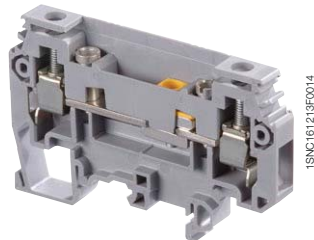

1SNC161219FD014

M6/8.ST

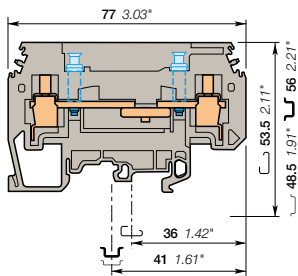

8 mm 0.315 in spacing

Description

- Secure your disconnect operations with the disconnect sliding link operated with a screwdriver,
- Ease your test operations with the 2 independent built-in test sockets compatible with DIA 4 mm 0.157 in test plugs.

Ordering details

Description	Color	Type	Order code	Pkg qty	Weight (1 pce)
Disconnect With 2 test sockets DIA 4 mm 0.157 in	Grey <input type="checkbox"/>	M6/8.ST1	1SNA115237R1000	25	30.00

Main technical data

Connecting capacity	IEC	UL	CSA	Mounting instructions	
1 conductor per clamp	Rigid - Solid / Stranded Flexible with insulated ferrule Gauge	0.5-10 mm ² 0.5-6 mm ² A5	18 - 8 AWG	18-8 AWG	Rail G32, TH 35-7.5, TH 35-15
				Wire stripping length	13 mm 0.51 in
				Screw clamp Tool	Flat screwdriver Ø 5 mm Ø 0.197 in
				Torque	0.8 - 1 N.m 7.1 - 8.9 lb.in
Rated current / Rated cross section	40 A / 6 mm ²	30 A / 8 AWG	30 A / 8 AWG	Disconnect device Tool	Flat screwdriver Ø 3.5 mm Ø 0.138 in
Rated short-time withstand current (1s)	720 A			Torque	0.4 - 0.6 N.m 3.5 - 5.3 lb.in
Rated voltage	630 V	150 V	150 V		
Impulse withstand voltage					
Protection		NEMA			

The connecting capacity data for one Rigid - Solid / Stranded - Flexible conductor (when applicable) is a mandatory information required by IEC, UL and CSA standards. All other data are provided as supplementary information only. For more details, please consult our CB, UL or CSA certificates and technical datasheet available on <http://www.abb.com>

--	--	--	--	--	--

Accessories

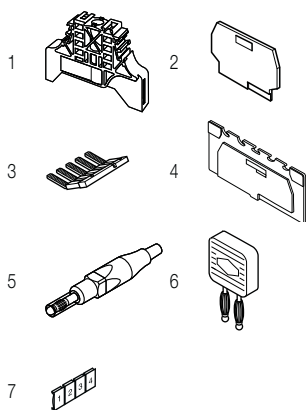

Description	Color	Type	Order code	Pkg qty	Weight (1 pce)
1 End stops	Grey <input type="checkbox"/>	BAM2	1SNA206351R1600	50	12.00
		BADL	1SNA399903R0200	50	4.70
2 End sections	Grey <input type="checkbox"/>	FEMT2	1SNA113629R2700	10	2.00
3 Lateral jumper bars 50 A	Black <input type="checkbox"/>	PC8-10	1SNA163313R2400	10	14.00
		PC8-R1	1SNA400711R0600	10	6.60
		PC8-R2	1SNA400712R0700	10	7.84
		PC8-R3	1SNA400713R0000	10	9.00
		PC8-R4	1SNA400724R0300	10	4.50
4 Circuit separators	Grey <input type="checkbox"/>	SCFT2	1SNA114522R0500	20	
5 Test plugs	Red <input type="checkbox"/>	FC4-1	1SNA167927R1000	10	11.00
6 Short circuit plugs		BP8-A4	1SNA173888R2000	10	
7 Terminal block markers	White <input type="checkbox"/>	RC810	1SNA234000R0200	1	8.20

Complete list of accessories is indicated in the terminal block datasheet. Some accessories such as jumper bars may modify the terminal block's ratings: complete information in the accessories catalogue pages.

Feed-through screw clamp terminal blocks

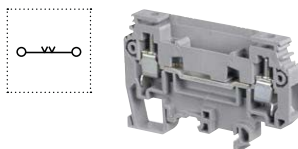

Description	Color	Type	Order code	Pkg qty	Weight (1 pce)
Feed-through Profile aligned with M6/8.ST...	Grey <input type="checkbox"/>	M6/8.ST7	1SNA115243R2600	25	20.00

All the technical data for UL/CSA standard and dimensions in inches are in italic. Technical data valid for copper conductors only.

M6/8.ST screw clamp terminal blocks

Test disconnect with insulated rod sliding link

8 mm 0.315 in spacing



6 mm²
8 AWG

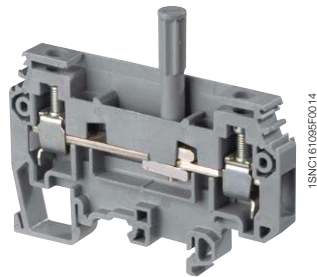

M6/8.ST

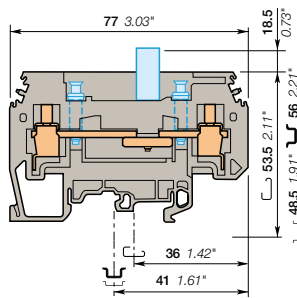

8 mm 0.315 in spacing

Description

- Secure your disconnect operations with the disconnect sliding link operated with a screwdriver,
- Ease your test operations with the two independent built-in test sockets compatible with DIA 4 mm 0.157 in test plugs.

Ordering details

Description	Color	Type	Order code	Pkg qty	Weight (1 pce) g
Disconnect With 2 test sockets DIA 4 mm 0.157 in	Grey <input type="checkbox"/>	M6/8.ST3	1SNA115239R2200	25	30.00

Main technical data

Connecting capacity	IEC	UL	CSA	Rail	Mounting instructions
1 conductor per clamp	Rigid - Solid / Stranded Flexible with insulated ferrule Gauge	0.5-10 mm ² 0.5-6 mm ² A5	18 - 8 AWG	18-8 AWG	Wire stripping length Screw clamp Tool Torque Disconnect device Tool Torque
Rated current / Rated cross section	40 A / 6 mm ²	30 A / 8 AWG	30 A / 8 AWG		G32, TH 35-7.5, TH 35-15 Flat screwdriver Ø 5 mm Ø 0.197 in 0.8 - 1 N.m 7.1 - 8.9 lb.in
Rated short-time withstand current (1s)	720 A				
Rated voltage	630 V	150 V	150 V		Flat screwdriver Ø 3.5 mm Ø 0.138 in
Impulse withstand voltage					0.4 - 0.6 N.m 3.5 - 5.3 lb.in
Protection		NEMA			

The connecting capacity data for one Rigid - Solid / Stranded - Flexible conductor (when applicable) is a mandatory information required by IEC, UL and CSA standards. All other data are provided as supplementary information only. For more details, please consult our CB, UL or CSA certificates and technical datasheet available on <http://www.abb.com>

CE	RoHS	UL	CSA	Gost R
----	------	----	-----	--------

Accessories

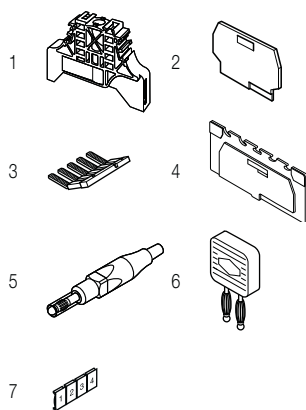

Description	Color	Type	Order code	Pkg qty	Weight (1 pce) g
1 End stops	Grey <input type="checkbox"/>	BAM2	1SNA206351R1600	50	12.00
		BADL	1SNA399903R0200	50	4.70
2 End sections	Grey <input type="checkbox"/>	FEMT2	1SNA113629R2700	10	2.00
3 Lateral jumper bars 50 A	Black <input type="checkbox"/>	PC8-10	1SNA163313R2400	10	14.00
		PC8-R1	1SNA400711R0600	10	6.60
		PC8-R2	1SNA400712R0700	10	7.84
		PC8-R3	1SNA400713R0000	10	9.00
		PC8-R4	1SNA400724R0300	10	4.50
4 Circuit separators	Grey <input type="checkbox"/>	SCFT2	1SNA114522R0500	20	
5 Test plugs	Red <input type="checkbox"/>	FC4-1	1SNA167927R1000	10	11.00
6 Short circuit plugs		BP8.A4	1SNA173888R2000	10	
7 Terminal block markers	White <input type="checkbox"/>	RC810	1SNA234000R0200	1	8.20

Complete list of accessories is indicated in the terminal block datasheet. Some accessories such as jumper bars may modify the terminal block's ratings: complete information in the accessories catalogue pages.

Feed-through screw clamp terminal blocks

Description	Color	Type	Order code	Pkg qty	Weight (1 pce) g
Feed-through Profile aligned with M6/8.ST...	Grey <input type="checkbox"/>	M6/8.ST7	1SNA115243R2600	25	20.00

All the technical data for UL/CSA standard and dimensions in inches are in *italy*. Technical data valid for copper conductors only.

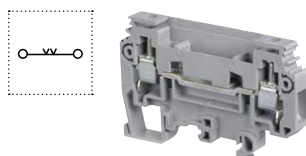

M6/8.ST screw clamp terminal blocks

Test disconnect with a screwdriver sliding link

8 mm 0.315 in spacing

2

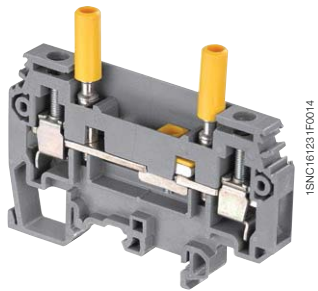

1SNC161231P0014

M6/8.ST

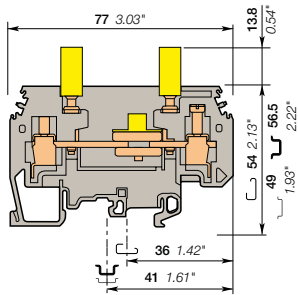

8 mm 0.315 in spacing

Description

Terminal blocks especially designed for current transformers circuits:

- Easy and secured current measurement thanks to the two built-in test yellow sockets compatible with IP20 DIA 4 mm 0.157 in test plugs,
- Convenient short-circuit operations with the PCS sliding short circuiting bridges from 2 to 4 poles,
- Tests sockets available as well in black, green, grey and blue.

Ordering details

Description	Color	Type	Order code	Pkg qty	Weight (1 pce)
Disconnect With two yellow test sockets DIA 4 mm 0.157 in	Grey <input type="checkbox"/>	M6/8.ST1.IP20	1SNA115971R1000	25	40.00

Main technical data

Connecting capacity	IEC	UL	CSA
1 conductor per clamp			
Rigid - Solid / Stranded	0.5 - 10 mm ²	18 - 8 AWG	18 - 8 AWG
Flexible with insulated ferrule	0.5 - 6 mm ²		
Gauge	A5		
Rated current / Rated cross section	40 A / 6 mm ²	30 A / 8 AWG	30 A / 8 AWG
Rated short-time withstand current (1s)	720 A		
Rated voltage	630 V	150 V	150 V
Impulse withstand voltage	8000 V		
Protection	IP20	NEMA 1	

Mounting instructions

Rail		G32, TH 35-7.5, TH 35-15
Wire stripping length		13 mm 0.51 in
Screw clamp Tool		Flat screwdriver Ø 3.5 mm Ø 0.138 in 0.8 - 1 N.m 7.1 - 8.9 lb.in
Torque		
Disconnect device Tool		Flat screwdriver Ø 3.5 mm Ø 0.138 in
Torque		0.5 N.m 4.45 lb.in
Test socket Tool		Flat screwdriver Ø 3.5 mm Ø 0.138 in
Torque		0.6 N.m 5.34 lb.in

The connecting capacity data for one Rigid - Solid / Stranded - Flexible conductor (when applicable) is a mandatory information required by IEC, UL and CSA standards. All other data are provided as supplementary information only. For more details, please consult our CB, UL or CSA certificates and technical datasheet available on <http://www.abb.com>

--	--	--	--	--

Accessories

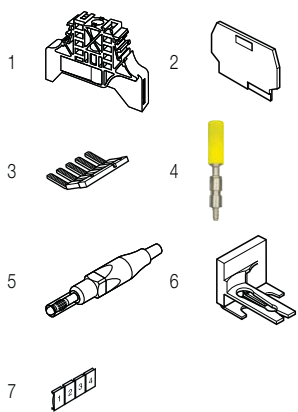

Description	Color	Type	Order code	Pkg qty	Weight (1 pce)	
1 End stops	Grey <input type="checkbox"/>	BAM2	1SNA206351R1600	50	12.00	
		BADL	1SNA399903R0200	50	4.70	
2 End sections	Grey <input type="checkbox"/>	FEMT2	1SNA113629R2700	10	2.00	
3 Lateral jumper bars 50 A	Black <input type="checkbox"/>	PC8-10	1SNA163313R2400	10	14.00	
		PC8-R1	1SNA400711R0600	10	6.60	
		PC8-R2	1SNA400712R0700	10	7.84	
		PC8-R3	1SNA400713R0000	10	9.00	
		PC8-R4	1SNA400724R0300	10	4.50	
4 Test sockets	DIA 4 mm 0.157 in IP20					
	Black <input type="checkbox"/>	AJS9-1	1SNA206680R1500	25	3.60	
	Green <input type="checkbox"/>	AJS9-2	1SNA206681R0200	25	3.60	
	Grey <input type="checkbox"/>	AJS9-3	1SNA206682R0300	25	3.60	
	Blue <input type="checkbox"/>	AJS9-4	1SNA206683R0400	25	3.60	
	Red <input type="checkbox"/>	AJS9-5	1SNA206720R1400	25	3.60	
5 Test plugs	DIA 4 mm 0.157 in IP20	Red <input type="checkbox"/>	FC4-1	1SNA167927R1000	10	11.00
6 Short circuit bridges	2 poles	Yellow <input type="checkbox"/>	SC-JB8-2	1SNK900652R0000	25	2.00
	3 poles		SC-JB8-3	1SNK900653R0000	25	3.40
	4 poles		SC-JB8-4	1SNK900654R0000	25	4.70
7 Terminal block markers	Blank card	White <input type="checkbox"/>	RC810	1SNA234000R0200	1	8.20

Complete list of accessories is indicated in the terminal block datasheet. Some accessories such as jumper bars may modify the terminal block's ratings: complete information in the accessories catalogue pages.

Feed-through screw clamp terminal blocks

Description	Color	Type	Order code	Pkg qty	Weight (1 pce)
Feed-through Profile aligned with M6/8.ST...	Grey <input type="checkbox"/>	M6/8.ST7	1SNA115243R2600	25	20.00

All the technical data for UL/CSA standard and dimensions in inches are in *italics*. Technical data valid for copper conductors only.

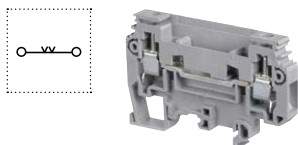

M6/8.ST screw clamp terminal blocks

Feed-through - 8 mm 0.315 in spacing

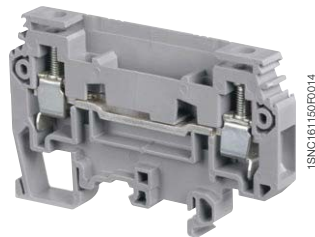

M6/8.ST

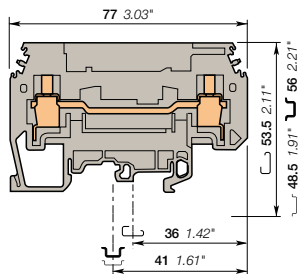

8 mm 0.315 in spacing

Description

Profile aligned with M6/8 ST.

Ordering details

Description	Color	Type	Order code	Pkg qty	Weight (1 pce) g
Feed-through	Grey <input type="checkbox"/>	M6/8.ST7	1SNA115243R2600	25	20.00

Main technical data

Connecting capacity		IEC	UL	CSA
1 conductor per clamp	Rigid - Solid / Stranded	0.5-10 mm ²	18 - 8 AWG	18-8 AWG
	Flexible with insulated ferrule	0.5-6 mm ²		
	Gauge	A5		
Rated current / Rated cross section		40 A / 6 mm ²	40 A / 8 AWG	40 A / 8 AWG
Rated short-time withstand current (1s)		720 A		
Rated voltage		630 V	150 V	150 V
Impulse withstand voltage				
Protection			NEMA	

Mounting instructions

Rail		G32, TH 35-7.5, TH 35-15
Wire stripping length		13 mm 0.51 in
Tool		Flat screwdriver Ø 5 mm Ø 0.197 in
Torque		0.8 - 1 N.m 7.1 - 8.9 lb.in

The connecting capacity data for one Rigid - Solid / Stranded - Flexible conductor (when applicable) is a mandatory information required by IEC, UL and CSA standards. All other data are provided as supplementary information only. For more details, please consult our CB, UL or CSA certificates and technical datasheet available on <http://www.abb.com>

--	--	--	--	--

Accessories

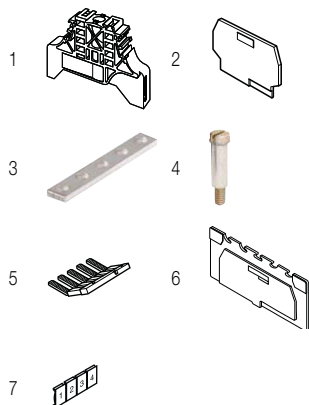

Description	Color	Type	Order code	Pkg qty	Weight (1 pce) g	
1 End stops	Grey <input type="checkbox"/>	BAM2	1SNA206351R1600	50	12.00	
		BADL	1SNA399903R0200	50	4.70	
2 End sections	Grey <input type="checkbox"/>	FEMT2	1SNA113629R2700	10	2.00	
3 Jumper bars		BJS8-20	1SNA174789R0500	5	3.20	
4 Fastening kits		Sub assembly post + screw + washer	EV8S	1SNA168401R0300	20	3.00
5 Lateral jumper bars	Black <input type="checkbox"/>	2 poles	PC8-2	1SNA116538R1700	10	3.00
		3 poles	PC8-3	1SNA116539R1000	10	4.00
		4 poles	PC8-4	1SNA116540R2500	10	6.00
		10 poles	PC8-10	1SNA163313R2400	10	14.00
			PC8-R1	1SNA400711R0600	10	6.60
			PC8-R2	1SNA400712R0700	10	7.84
			PC8-R3	1SNA400713R0000	10	9.00
	PC8-R4	1SNA400724R0300	10	4.50		
6 Circuit separators	Grey <input type="checkbox"/>	SCFT2	1SNA114522R0500	20	8.20	
7 Terminal block markers	White <input type="checkbox"/>	RC810	1SNA234000R0200	1	8.20	

Complete list of accessories is indicated in the terminal block datasheet.

Some accessories such as jumper bars may modify the terminal block's ratings: complete information in the accessories catalogue pages.

All the technical data for UL/CSA standard and dimensions in inches are in italic.
Technical data valid for copper conductors only.

M4/8.SF screw clamp terminal blocks

For 5 x 20 and 5 x 25 fuses - 8 mm 0.315 in spacing



Description

Protect your circuits with 5x20 and 5x25 fuse terminal blocks (fuse not supplied with terminal blocks).

Ordering details

Description	Color	Type	Order code	Pkg qty	Weight (1 pce) g
Fuse	Grey <input type="checkbox"/>	M4/8.SF	1SNA115657R2500	50	14.00

Main technical data

Connecting capacity		IEC	UL	CSA
1 conductor per clamp	Rigid - Solid / Stranded	0.5-6 mm ²	22-12 AWG	24-12 AWG
	Flexible with insulated ferrule	0.5-4 mm ²		
	Gauge	A4		
Rated current / Rated cross section		6.3 A / 4 mm ²	15 A / 12 AWG	10 A / 12 AWG
Rated short-time withstand current (1s)				
Rated voltage		630 V	600 V	250 V
Impulse withstand voltage		8000 V		
Protection		IP20	NEMA 1	

Mounting instructions

Rail		G32, TH 35-7.5, TH 35-15
Wire stripping length		9.5 mm 0.37 in
Tool		Flat screwdriver Ø 4 mm Ø 0.157 in
Torque		0.5 - 0.8 N.m 4.4 - 7.1 lb.in

The connecting capacity data for one Rigid - Solid / Stranded - Flexible conductor (when applicable) is a mandatory information required by IEC, UL and CSA standards. All other data are provided as supplementary information only. For more details, please consult our CB, UL or CSA certificates and technical datasheet available on <http://www.abb.com>

CE	RoHS	ULSR	CSA	Gost R



M4/8.SF

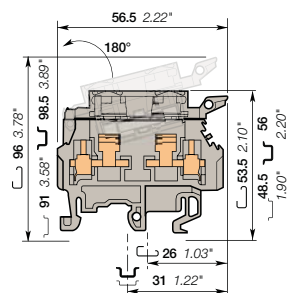

8 mm 0.315 in spacing

Accessories

Description	Color	Type	Order code	Pkg qty	Weight (1 pce) g	
1 End stops	Grey <input type="checkbox"/>	10 mm	BAM2	1SNA206351R1600	50	12.00
		9 mm	BADL	1SNA399903R0200	50	4.70
2 End sections	Grey <input type="checkbox"/>	1.5 mm	FEM8S	1SNA116951R1500	20	2.60
3 Jumper bars	Grey <input type="checkbox"/>	1 poles	AD2.5	1SNA114205R2000	50	1.60
4 Lateral jumper bars		10 poles	PC81-10	1SNA173523R1100	10	5.00
5 Fuses	Grey <input type="checkbox"/>	0.5 A	FU520	1SNA008288R1500	10	
		3.15 A		1SNA008289R1600	10	
		1 A		1SNA008290R1300	10	
		2 A		1SNA008291R0000	10	
		5 A		1SNA008292R0100	10	
6 Assembly rods	Grey <input type="checkbox"/>	2 poles	TGA8	1SNA168672R1100	10	1.00
		3 poles		1SNA168673R1200	10	
		4 poles		1SNA168674R1300	10	
		Neutral cartridges	CN5	1SNA179371R1600	10	3.90
8 Spring retaining rings	White <input type="checkbox"/>	ANT	1SNA168675R1400	10		
9 Terminal block markers	White <input type="checkbox"/>	RC810	1SNA234000R0200	1	8.20	

Complete list of accessories is indicated in the terminal block datasheet. Some accessories such as jumper bars may modify the terminal block's ratings: complete information in the accessories catalogue pages.

Feed-through screw clamp terminal blocks

Description	Color	Type	Order code	Pkg qty	Weight (1 pce) g
Feed-through	Grey <input type="checkbox"/>	M4/8	1SNA115523R0700	50	11.00

All the technical data for UL/CSA standard and dimensions in inches are in italic. Technical data valid for copper conductors only.

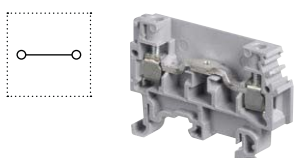
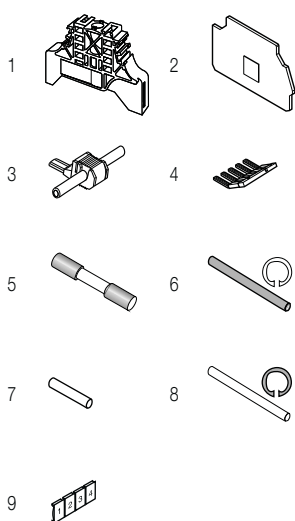

M4/8.SF screw clamp terminal blocks

For 5x20 and 5x25 fuses - 8 mm 0.315 in spacing

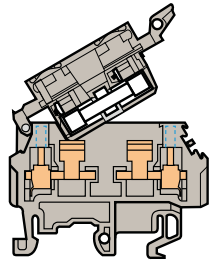

8 mm 0.315 in spacing

Standard block

Ordering details

Description	Color	Type	Order code	Pkg qty	Weight (1 pce) g
Fuse	Orange	M4/8.SF2	1SNA105135R1100	50	14.00

Main technical data	IEC	UL	CSA	Nota
Rated voltage	630 V	600 V		
Impulse withstand voltage	8000 V			
Protection	IP20	NEMA 1		

--	--	--	--	--	--	--	--	--	--	--	--	--	--	--	--	--	--	--	--	--

2

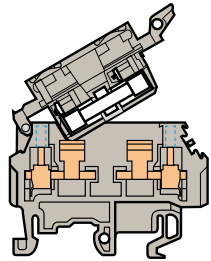
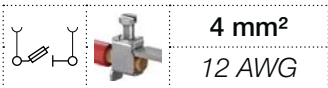

8 mm 0.315 in spacing

With 2 test socket DIA 2 mm 0.079 in

Ordering details

Description	Color	Type	Order code	Pkg qty	Weight (1 pce) g
Fuse With 2 test socket DIA 2 mm 0.079 in	Grey	M4/8.SFT	1SNA115662R2200	50	14.00

Main technical data	IEC	UL	CSA	Nota
Rated voltage	400 V	600 V	250 V	
Impulse withstand voltage	4000 V			
Protection	IP20	NEMA 1		

--	--	--	--	--	--	--	--	--	--	--	--	--	--	--	--	--	--	--	--	--

Accessories

Description	Color	Type	Order code	Pkg qty	Weight (1 pce) g
1 Test plugs DIA 2 mm 0.079 in	Black	FC2	1SNA007865R2600	100	



1

All the technical data for UL/CSA standard and dimensions in inches are in italic.
Technical data valid for copper conductors only.

M4/8.SF screw clamp terminal blocks

For 5x20 and 5x25 fuses - With blown fuse indicator

8 mm 0.315 in spacing



Description

- Protect your circuits with 5x20 and 5x25 fuse terminal blocks (fuse not supplied with terminal blocks),
- Quickly identify the defective circuit thanks to the blown fuse indicator.

Ordering details

Description	Color	Type	Order code	Pkg qty	Weight (1 pce) g
Fuse With blown fuse indicator by LED 24-60 V DC/ 110 V AC	Grey <input type="checkbox"/>	M4/8.SFD3	1SNA115935R0400	50	14.00

Main technical data

Connecting capacity	IEC	UL	CSA	Mounting instructions
1 conductor per clamp Rigid - Solid / Stranded Flexible with insulated ferrule Gauge	0.5-6 mm ² 0.5-4 mm ² A4			Rail G32, TH 35-7.5, TH 35-15 Wire stripping length 9.5 mm 0.374 in Tool Flat screwdriver Ø 4 mm Ø 0.157 in
Rated current / Rated cross section	6.3 A / 4 mm ²			
Rated short-time withstand current (1s)				Torque 0.5 - 0.8 N.m 4.4 - 7.1 lb.in
Rated voltage	400 V			
Impulse withstand voltage	4000 V			
Protection	IP20	NEMA 1		

The connecting capacity data for one Rigid - Solid / Stranded - Flexible conductor (when applicable) is a mandatory information required by IEC, UL and CSA standards. All other data are provided as supplementary information only. For more details, please consult our CB, UL or CSA certificates and technical datasheet available on <http://www.abb.com>

--	--	--

Notes

- Blocks with LED indicator are labeled "+" on the outside of the lever. The indicator can be reversed in the field if required.
- Leakage current : 24 V : < 0.5 mA / 110 V : < 2.2 mA

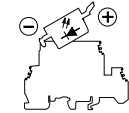

M4/8.SF

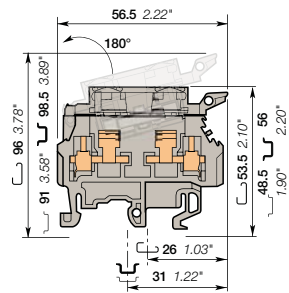

8 mm 0.315 in spacing

Accessories

Description	Color	Type	Order code	Pkg qty	Weight (1 pce) g
1 End stops 10 mm 0.394 in 9 mm 0.354 in	Grey <input type="checkbox"/>	BAM2 BADL	1SNA206351R1600 1SNA399903R0200	50 50	12.00 4.70
2 End sections 1.5 mm 0.059 in	Grey <input type="checkbox"/>	FEM8S	1SNA116951R1500	20	2.60
3 Jumper bars 1 poles 24 A	Grey <input type="checkbox"/>	AD2.5	1SNA114205R2000	50	1.60
4 Lateral jumper bars 10 poles 35 A		PC81-10	1SNA173523R1100	10	5.00
5 Fuses 0.5 A 3.15 A 1 A 2 A 5 A		FU520	1SNA008288R1500 1SNA008289R1600 1SNA008290R1300 1SNA008291R0000 1SNA008292R0100	10 10 10 10 10	
6 Assembly rods 2 poles 3 poles 4 poles		TGA8	1SNA168672R1100 1SNA168673R1200 1SNA168674R1300	10 10 10	1.00
7 Spring retaining rings		ANT	1SNA168675R1400	10	
8 Terminal block markers Blank card	White <input type="checkbox"/>	RC810	1SNA234000R0200	1	8.20

Complete list of accessories is indicated in the terminal block datasheet. Some accessories such as jumper bars may modify the terminal block's ratings: complete information in the accessories catalogue pages.

All the technical data for UL/CSA standard and dimensions in inches are in italic. Technical data valid for copper conductors only.

M4/8.SF screw clamp terminal blocks

For 5x20 and 5x25 fuses - With blown fuse indicator

8 mm 0.315 in spacing

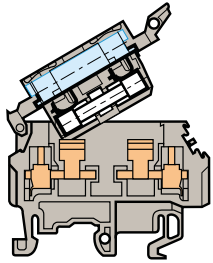

8 mm 0.315 in spacing

With blown fuse indicator

Ordering details

Description	Color	Type	Order code	Pkg qty	Weight (1 pce) g
Fuse With blown fuse indicator by neon 110-230 V AC	Grey <input type="checkbox"/>	M4/8.SFL	1SNA115661R2100	50	14.00
With blown fuse indicator by LED 24 V AC/DC	Grey <input type="checkbox"/>	M4/8.SFD	1SNA115663R2300	50	14.00

Main technical data	IEC	UL	CSA	Leakage current :
Rated voltage	400 V	600 V	250 V	24 V : < 4.5 mA
Impulse withstand voltage	4000 V			110 V : < 0.5 mA
Protection	IP20	NEMA 1		230 V : < 0.7 mA



2

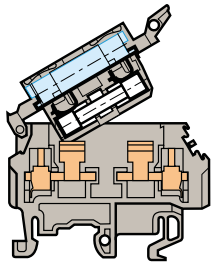
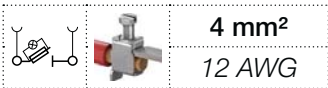

8 mm 0.315 in spacing

With blown fuse indicator and 2 test socket DIA 2 mm 0.079 in

Ordering details

Description	Color	Type	Order code	Pkg qty	Weight (1 pce) g
Fuse With blown fuse indicator by LED 24 V AC/DC and 2 test socket DIA 2 mm 0.079 in	Grey <input type="checkbox"/>	M4/8.SFDT	1SNA115665R2500	50	14.00
With blown fuse indicator by neon 110-230 V AC and 2 test socket DIA 2 mm 0.079 in	Grey <input type="checkbox"/>	M4/8.SFLT	1SNA115667R2700	50	14.00

Main technical data	IEC	UL	CSA	Leakage current :
Rated voltage	400 V	600 V	250 V	24 V : < 4.5 mA
Impulse withstand voltage	4000 V			110 V : < 0.5 mA
Protection	IP20	NEMA 1		230 V : < 0.7 mA

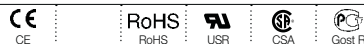

Accessories

Description	Color	Type	Order code	Pkg qty	Weight (1 pce) g
1 Test plugs DIA 2 mm 0.079 in	Black <input checked="" type="checkbox"/>	FC2	1SNA007865R2600	100	



1

All the technical data for UL/CSA standard and dimensions in inches are in italic. Technical data valid for copper conductors only.

M4/8.SN screw clamp terminal blocks

Disconnect with lever - with test socket - 8 mm 0.315 in spacing



2

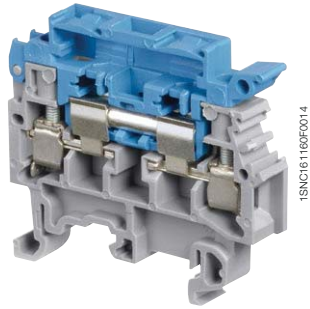

1SNC1611609001.4

M4/8.SN

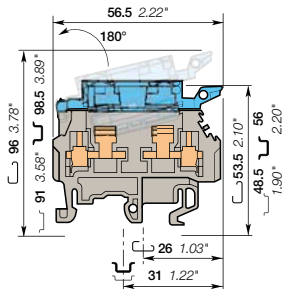

8 mm 0.315 in spacing

Description

- Simplify the disconnect operations for the disconnect terminal blocks installed next to fuse terminal blocks M4/8.SF...
- With the same profile as M4/8.SF, the M4/8.SN disconnect lever is easily operated by hand and the wiring of the alternated disconnect and fuse circuits is easier,
- Link bar for lever included in terminal.

Ordering details

Description	Color	Type	Order code	Pkg qty	Weight (1 pce) g
Disconnect	Grey, blue	M4/8.SN	1SNA115659R0700	50	13.00
Disconnect with 2 test socket DIA 2 mm 0.079 in	Grey, blue	M4/8.SNT	1SNA115668R0000	50	13.00

Main technical data

Connecting capacity		IEC	UL	CSA	Mounting instructions	
1 conductor per clamp	Rigid - Solid / Stranded	0.5-6 mm ²	22-12 AWG	24-12 AWG	Rail	G32, TH 35-7.5, TH 35-15
	Flexible with insulated ferrule	0.5-4 mm ²			Wire stripping length	9.5 mm 0.37 in
	Gauge	A4			Tool	Flat screwdriver Ø 4 mm Ø 0.157 in
Rated current / Rated cross section		6.3 A / 4 mm ²	15 A / 12 AWG	10 A / 12 AWG	Torque	0.5 - 0.8 N.m 4.4 - 7.1 lb.in
Rated short-time withstand current (1s)		90 A				
Rated voltage		630 V	600 V	250 V		
Impulse withstand voltage		8000 V				
Protection		IP20	NEMA 1			

The connecting capacity data for one Rigid - Solid / Stranded - Flexible conductor (when applicable) is a mandatory information required by IEC, UL and CSA standards. All other data are provided as supplementary information only. For more details, please consult our CB, UL or CSA certificates and technical datasheet available on <http://www.abb.com>

CE	RoHS	UR	CSA	Gost R
----	------	----	-----	--------

Accessories

Description	Color	Type	Order code	Pkg qty	Weight (1 pce) g
1 End stops	Grey	BAM2	1SNA206351R1600	50	12.00
		BADL	1SNA399903R0200	50	4.70
2 End sections	Grey	FEM8S	1SNA116951R1500	20	2.60
3 Lateral jumper bars		PC81-10	1SNA173523R1100	10	5.00
4 Assembly rods		TGA8	1SNA168672R1100	10	1.00
			1SNA168673R1200	10	
			1SNA168674R1300	10	
			1SNA168675R1400	10	
5 Spring retaining rings		ANT	1SNA168675R1400	10	
6 Terminal block markers	White	RC810	1SNA234000R0200	1	8.20

Complete list of accessories is indicated in the terminal block datasheet. Some accessories such as jumper bars may modify the terminal block's ratings: complete information in the accessories catalogue pages.

All the technical data for UL/CSA standard and dimensions in inches are in italic. Technical data valid for copper conductors only.

M4/8 screw clamp terminal blocks

Feed-Through - 8 mm 0.315 in spacing



4 mm²



M4/8

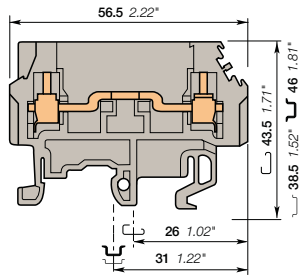

8 mm 0.315 in spacing

Description

- Simplify the alternated feed-through and fuse circuits operations,
- With the same profile as M4/8.SF, the wiring of the alternated feed-through and fuse circuits is easier.

Ordering details

Description	Color	Type	Order code	Pkg qty	Weight (1 pce) g
Feed-Through	Grey <input type="checkbox"/>	M4/8	1SNA115523R0700	50	11.00

Main technical data

Connecting capacity		IEC	UL	CSA	Mounting instructions	
1 conductor per clamp	Rigid - Solid / Stranded	0.2-4 mm ²			Rail	G32, TH 35-7.5, TH 35-15
	Flexible with insulated ferrule	0.22-4 mm ²			Wire stripping length	9.5 mm 0.37 in
	Gauge	A4			Tool	Flat screwdriver Ø 4 mm Ø 0.157 in
Rated current / Rated cross section		26 A / 4 mm ²			Torque	0.5 - 0.8 N.m 4.4 - 7.1 lb.in
Rated short-time withstand current (1s)		480 A				
Rated voltage		500 V				
Impulse withstand voltage						
Protection				NEMA		

The connecting capacity data for one Rigid - Solid / Stranded - Flexible conductor (when applicable) is a mandatory information required by IEC, UL and CSA standards. All other data are provided as supplementary information only, for more details, please consult our CB, UL or CSA certificates and technical datasheet available on <http://www.abb.com>

CE	RoHS	Gost R			
----	------	--------	--	--	--

Accessories

Description	Color	Type	Order code	Pkg qty	Weight (1 pce) g
1 End stops	Grey <input type="checkbox"/>	BAM2	1SNA206351R1600	50	12.00
		BADL	1SNA399903R0200	50	4.70
2 End sections	Grey <input type="checkbox"/>	FEM8S	1SNA116951R1500	20	2.60
3 Jumper bars	Grey <input type="checkbox"/>	AD2.5	1SNA114205R2000	50	1.60
4 Lateral jumper bars		PC81-10	1SNA173523R1100	10	5.00
5 Test sockets		AL2	1SNA163070R0000	50	
		AL3	1SNA163261R0000	50	1.20
6 Test plugs	Black <input type="checkbox"/>	FC2	1SNA007865R2600	100	
7 Terminal block markers	White <input type="checkbox"/>	RC810	1SNA234000R0200	1	8.20

Complete list of accessories is indicated in the terminal block datasheet. Some accessories such as jumper bars may modify the terminal block's ratings: complete information in the accessories catalogue pages.

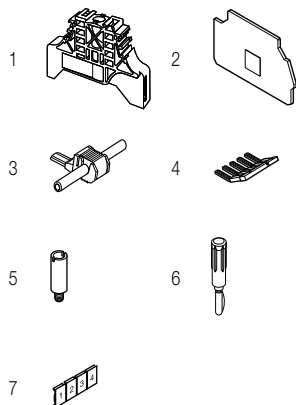

All the technical data for UL/CSA standard and dimensions in inches are in italic. Technical data valid for copper conductors only.

M4/8.D2.SF screw clamp terminal blocks

For 5 x 20 and 5 x 25 fuses - 8 mm 0.315 in spacing



2



M4/8.D2.SF

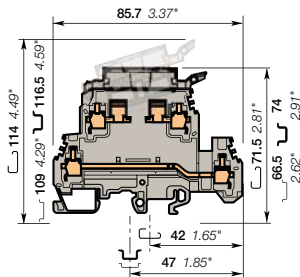

8 mm 0.315 in spacing

Description

- Protect your circuits with 5x20 and 5x25 fuse terminal blocks (fuse not supplied with terminal blocks),
- Save space with double deck terminal blocks: 2 independent circuits 1 fuse on upper deck + 1 feed-through.

Ordering details

Description	Color	Type	Order code	Pkg qty	Weight (1 pce) g
Fuse	Grey <input type="checkbox"/>	M4/8.D2.SF	1SNA115604R2100	50	26.00

Main technical data

Connecting capacity		IEC	UL	CSA	Mounting instructions	
1 conductor per clamp	Rigid - Solid / Stranded	0.5-6 mm ²	24-12 AWG	24-12 AWG	Rail	G32, TH 35-7.5, TH 35-15
	Flexible with insulated ferrule	0.5-4 mm ²			Wire stripping length	9.5 mm 0.37 in
	Gauge	A4			Tool	Flat screwdriver Ø 4 mm Ø 0.157 in
Rated current / Rated cross section		6.3 A / 4 mm ²	20 A / 12 AWG	10 A / 12 AWG	Torque	0.5 - 0.8 N.m 4.4 - 7.1 lb.in
Rated short-time withstand current (1s)						
Rated voltage		630 V	300 V	250 V		
Impulse withstand voltage		8000 V				
Protection		IP20	NEMA 1			

The connecting capacity data for one Rigid - Solid / Stranded - Flexible conductor (when applicable) is a mandatory information required by IEC, UL and CSA standards. All other data are provided as supplementary information only. For more details, please consult our CB, UL or CSA certificates and technical datasheet available on <http://www.abb.com>

CE	RoHS	UL US	CSA	Gost R

Accessories

Description	Color	Type	Order code	Pkg qty	Weight (1 pce) g		
1 End stops	Grey <input type="checkbox"/>	BADH	1SNA116900R2700	50	24.00		
2 End sections	Grey <input type="checkbox"/>	FEM8D2S	1SNA116913R0700	20	10.00		
3 Jumper bars		2 poles	41 A	BJM18-2	1SNA176669R1600	10	4.50
		3 poles		BJM18-3	1SNA176670R1300	10	6.00
		4 poles		BJM18-4	1SNA176671R0000	10	10.00
		10 poles		BJM18-10	1SNA176673R0200	10	20.00
4 Lateral jumper bars		10 poles	35 A	PC81-10	1SNA173523R1100	10	5.00
5 Cross spacing jumpers		5 mm 0.200 in - 6 mm 0.236 in - 8 mm 0.315 in		EL6	1SNA173627R2100	10	0.10
6 Test sockets		DIA 2 mm 0.079 in		AL2	1SNA163043R2100	50	0.90
		DIA 3 mm 0.120 in		AL3	1SNA163261R0000	50	1.20
		DIA 4 mm 0.157 in		AL4-M3	1SNA206721R0100	50	1.10
7 Fuses		0.5 A		FU520	1SNA008288R1500	10	
		1 A			1SNA008290R1300	10	
		2 A			1SNA008291R0000	10	
8 Assembly rods		2 poles		TGA8	1SNA168672R1100	10	1.00
		3 poles			1SNA168673R1200	10	
		4 poles			1SNA168674R1300	10	
9 Neutral cartridges				CN5	1SNA179371R1600	10	3.90
10 Spring retaining rings				ANT	1SNA168675R1400	10	
11 Terminal block markers	White <input type="checkbox"/>	Blank card		RC810	1SNA234000R0200	1	8.20

Complete list of accessories is indicated in the terminal block datasheet.

Some accessories such as jumper bars may modify the terminal block's ratings: complete information in the accessories catalogue pages.

All the technical data for UL/CSA standard and dimensions in inches are in italic. Technical data valid for copper conductors only.

M4/8.D2.SF screw clamp terminal blocks

For 5 x 20 and 5 x 25 fuses - with blown fuse indicator

8 mm 0.315 in spacing

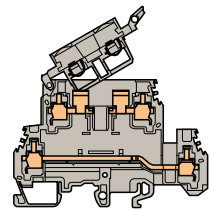
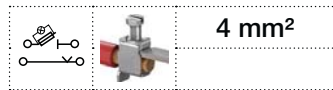

8 mm 0.315 in spacing

With blown fuse indicator by LED

Ordering details

Description	Color	Type	Order code	Pkg qty	Weight (1 pce) g
Fuse With blown fuse indicator by LED 24-60 V DC / 110 V AC	Grey <input type="checkbox"/>	M4/8.D2.SFD3	1SNA115936R0500	50	30.00

Main technical data	IEC	UL	CSA	Leakage current :
Rated voltage	500 V			24 V : < 0.5 mA
Impulse withstand voltage	6000 V			110 V : < 2.2 mA
Protection	IP20	NEMA 1		
CE	RoHS	Gost R		

2

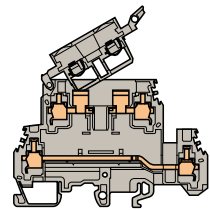

8 mm 0.315 in spacing

With blown fuse indicator by neon

Ordering details

Description	Color	Type	Order code	Pkg qty	Weight (1 pce) g
Fuse With blown fuse indicator by neon 110-230 V AC	Grey <input type="checkbox"/>	M4/8.D2.SFL	1SNA115646R2200	50	30.00

Main technical data	IEC	UL	CSA	Leakage current :
Rated voltage	500 V	300 V	250 V	110 V : < 0.5 mA
Impulse withstand voltage	6000 V			230 V : < 0.7 mA
Protection	IP20	NEMA 1		
CE	RoHS	UL	CSA	Gost R

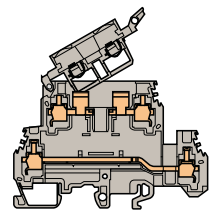
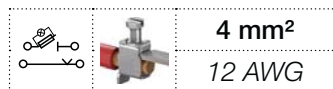

8 mm 0.315 in spacing

With blown fuse indicator

Ordering details

Description	Color	Type	Order code	Pkg qty	Weight (1 pce) g
Fuse With blown fuse indicator by LED 24 V AC/DC	Grey <input type="checkbox"/>	M4/8.D2.SFD	1SNA115647R2300	50	30.00

Main technical data	IEC	UL	CSA	Leakage current :
Rated voltage	500 V		250 V	24 V : < 4.5 mA
Impulse withstand voltage	6000 V			
Protection	IP20	NEMA 1		
CE	RoHS	CSA	Gost R	

All the technical data for UL/CSA standard and dimensions in inches are in italic.
Technical data valid for copper conductors only.

D4/8.D2.P.SF screw clamp terminal blocks

For 5 x 20 and 5 x 25 fuses - 8 mm 0.315 in spacing



Description

- Protect your circuits with 5x20 and 5x25 fuse terminal blocks (fuse not supplied with terminal blocks),
- Save space with double deck terminal blocks: 2 independent circuits 1 fuse on upper deck + 1 feed-through + 1 ground.

Ordering details

Description	Color	Type	Order code	Pkg qty	Weight (1 pce) g
Fuse	Grey <input type="checkbox"/>	D4/8.D2.P.SF	1SNA400270R2000	25	35.00

Main technical data

Connecting capacity	IEC	UL	CSA
1 conductor per clamp			
Rigid - Solid / Stranded	0.5-6 mm ²	20-12 AWG	20-12 AWG
Flexible with insulated ferrule	0.5-4 mm ²		
Gauge	A4		
Rated current / Rated cross section	6.3 A / 4 mm ²	6.3 A / 12 AWG	6.3 A / 12 AWG
Rated short-time withstand current (1s)			
Rated voltage	300 V	300 V	300 V
Impulse withstand voltage	6000 V		
Protection	IP20	NEMA 1	

Mounting instructions

Rail		TH 35-7.5, TH 35-15
Wire stripping length		9.5 mm 0.37 in
Tool		Flat screwdriver Ø 4 mm Ø 0.157 in
Torque		0.5 - 0.8 N.m 4.4 - 7.1 lb.in

The connecting capacity data for one Rigid - Solid / Stranded - Flexible conductor (when applicable) is a mandatory information required by IEC, UL and CSA standards. All other data are provided as supplementary information only. For more details, please consult our CB, UL or CSA certificates and technical datasheet available on <http://www.abb.com>

CE	RoHS	ULR	CSA	Gost R

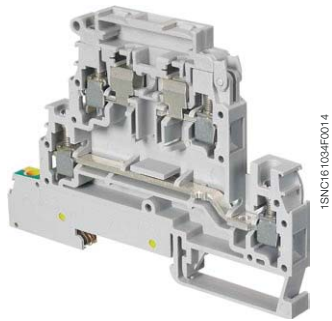

D4/8.D2.P.SF

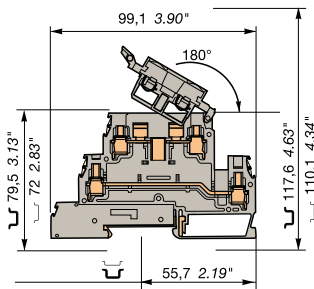

8 mm 0.315 in spacing

Accessories

Description	Color	Type	Order code	Pkg qty	Weight (1 pce) g
1 End stops 12 mm 0.472 in	Grey <input type="checkbox"/>	BADH	1SNA116900R2700	50	24.00
2 End sections 1.5 mm 0.059 in	Grey <input type="checkbox"/>	FEM8D2S1	1SNA400273R1700	20	4.60
3 Jumper bars 2 poles 41 A		BJM8	1SNA168520R0500	10	5.00
3 poles			1SNA168521R2200	10	7.00
4 poles			1SNA168522R2300	10	9.50
10 poles			1SNA168974R0000	10	23.70
4 Lateral jumper bars 10 poles 35 A		PC81-10	1SNA173523R1100	10	5.00
5 Cross spacing jumpers 5 mm 0.200 in - 6 mm 0.236 in - 8 mm 0.315 in		EL6	1SNA173627R2100	10	0.10
6 Test sockets DIA 2 mm 0.079 in		AL2	1SNA163043R2100	50	0.90
DIA 4 mm 0.157 in		AL4-M3	1SNA206721R0100	50	1.10
7 Fuses 0.5 A		FU520	1SNA008288R1500	10	
1 A			1SNA008290R1300	10	
2 A			1SNA008291R0000	10	
8 Assembly rods 2 poles		TGA8	1SNA168672R1100	10	1.00
3 poles			1SNA168673R1200	10	
4 poles			1SNA168674R1300	10	
9 Neutral cartridges		CN5	1SNA179371R1600	10	3.90
10 Spring retaining rings		ANT	1SNA168675R1400	10	
11 Terminal block markers Blank card	White <input type="checkbox"/>	RC810	1SNA234000R0200	1	8.20

Complete list of accessories is indicated in the terminal block datasheet.

Some accessories such as jumper bars may modify the terminal block's ratings: complete information in the accessories catalogue pages.

All the technical data for UL/CSA standard and dimensions in inches are in italic.
Technical data valid for copper conductors only.

D4/8.D2.P.SF screw clamp terminal blocks

For 5 x 20 and 5 x 25 fuses - with blown fuse indicator

8 mm 0.315 in spacing

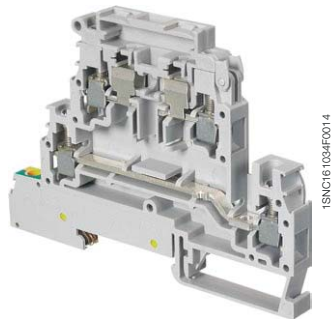

D4/8.D2.P.SF

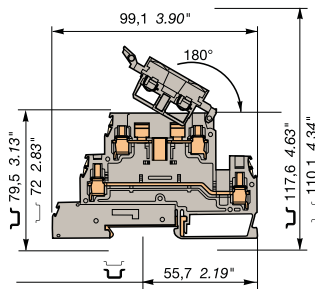

8 mm 0.315 in spacing

Description

- Protect your circuits with 5x20 and 5x25 fuse terminal blocks (fuse not supplied with terminal blocks),
- Save space with double deck terminal blocks: 2 independent circuits 1 fuse on upper deck + 1 feed-through + 1 ground,
- Quickly identify the defective circuit thanks to the blown fuse indicator.

Ordering details

Description	Color	Type	Order code	Pkg qty	Weight (1 pce) g
Fuse With blown fuse indicator by neon 110-230 V AC	Grey <input type="checkbox"/>	D4/8.D2.PSFL	1SNA400271R1500	25	35.00
Fuse With blown fuse indicator by LED 24-60 V DC / 110 V AC	Grey <input type="checkbox"/>	D4/8.D2.PSFD	1SNA400272R1600	25	35.00

Main technical data

Connecting capacity	IEC	UL	CSA
1 conductor per clamp	Rigid - Solid / Stranded Flexible with insulated ferrule Gauge	0.5-6 mm ² 0.5-4 mm ² A4	20-12 AWG 20-12 AWG
Rated current / Rated cross section	6.3 A / 4 mm ²	6.3 A / 12 AWG	6.3 A / 12 AWG
Rated short-time withstand current (1s)			
Rated voltage	300 V	300 V	300 V
Impulse withstand voltage	6000 V		
Protection	IP20	NEMA 1	

Mounting instructions

Rail		TH 35-7.5, TH 35-15
Wire stripping length		9.5 mm 0.37 in
Tool		Flat screwdriver Ø 4 mm Ø 0.157 in
Torque		0.5 - 0.8 N.m 4.4 - 7.1 lb.in

The connecting capacity data for one Rigid - Solid / Stranded - Flexible conductor (when applicable) is a mandatory information required by IEC, UL and CSA standards. All other data are provided as supplementary information only. For more details, please consult our CB, UL or CSA certificates and technical datasheet available on <http://www.abb.com>

--	--	--	--	--

Notes



- Blocks with LED indicator are labeled "+" on the outside of the lever. The indicator can be reversed in the field if required.
- Leakage current D4/8.D2.PSFL : 110 V : < 0.5 mA / 230 V : < 0.7 mA
- Leakage current D4/8.D2.PSFD : 24 V : < 0.5 mA / 110 V : < 2.2 mA

Accessories

Description	Color	Type	Order code	Pkg qty	Weight (1 pce) g
1 End stops	Grey <input type="checkbox"/>	BADH	1SNA116900R2700	50	24.00
2 End sections	Grey <input type="checkbox"/>	FEM8D2S1	1SNA400273R1700	20	4.60
3 Jumper bars		BJM8	1SNA168520R0500	10	5.00
			1SNA168521R2200	10	7.00
			1SNA168522R2300	10	9.50
			1SNA168974R0000	10	23.70
4 Lateral jumper bars		PC81-10	1SNA173523R1100	10	5.00
5 Cross spacing jumpers		EL6	1SNA173627R2100	10	0.10
6 Test sockets		AL2	1SNA163043R2100	50	0.90
		AL4-M3	1SNA206721R0100	50	1.10
7 Fuses		FJ520	1SNA008288R1500	10	
			1SNA008290R1300	10	
			1SNA008291R0000	10	
8 Assembly rods		TGA8	1SNA168672R1100	10	1.00
			1SNA168673R1200	10	
			1SNA168674R1300	10	
9 Neutral cartridges		CN5	1SNA179371R1600	10	3.90
10 Spring retaining rings		ANT	1SNA168675R1400	10	
11 Terminal block markers	White <input type="checkbox"/>	RC810	1SNA234000R0200	1	8.20

Complete list of accessories is indicated in the terminal block datasheet. Some accessories such as jumper bars may modify the terminal block's ratings: complete information in the accessories catalogue pages.

All the technical data for UL/CSA standard and dimensions in inches are in *italics*. Technical data valid for copper conductors only.

ML10/13.SF screw clamp terminal blocks

For 6.3 x 25 and 6.3 x 32 fuses - 13 mm 0.512 in spacing







Description

Protect your circuits with 6.35 x 25.4 mm ($\frac{1}{4} \times 1$ in) and 6.35 x 32 mm ($\frac{1}{4} \times 1\frac{1}{4}$ in) fuse terminal blocks (fuse not supplied with terminal blocks).

Ordering details

Description	Color	Type	Order code	Pkg qty	Weight (1 pce)
Fuse	Black ■	ML10/13.SF	1SNA199095R1300	20	51.00

Main technical data

Connecting capacity	IEC	UL	CSA	Mounting instructions	
1 conductor per clamp	Rigid - Solid / Stranded Flexible with insulated ferrule Gauge	0.5-16 mm ² 0.5-10 mm ² A6	22-10 AWG	22-8 AWG	Rail  G32, TH 35-7.5, TH 35-15 Wire stripping length  12 mm 0.472 in Tool  Flat screwdriver Ø 5.5 mm Ø 0.217 in
Rated current / Rated cross section	10 A / 10 mm ²	25 A / 10 AWG	25 A / 8 AWG		
Rated short-time withstand current (1s)					
Rated voltage	800 V	600 V	600 V		
Impulse withstand voltage	8000 V				
Protection	NEMA				
Torque  1.2 - 1.4 N.m 10.6 - 12.3 lb.in					

The connecting capacity data for one Rigid - Solid / Stranded - Flexible conductor (when applicable) is a mandatory information required by IEC, UL and CSA standards. All other data are provided as supplementary information only. For more details, please consult our CB, UL or CSA certificates and technical datasheet available on <http://www.abb.com>

CE	RoHS	USR	CSA	Gost R					
----	------	-----	-----	--------	--	--	--	--	--

Notes

A: Use of the BJS requires the user to cut out the partition.

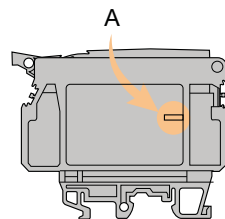

ML10/13.SF

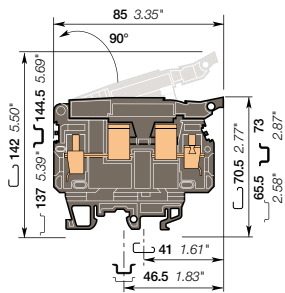

13 mm 0.512 in spacing

Accessories

Description	Color	Type	Order code	Pkg qty	Weight (1 pce)
1 End stops	Grey □	BAM2	1SNA206351R1600	50	12.00
		BADL	1SNA206659R2300	50	4.70
2 End sections	Black ■	FEM13U	1SNA199635R2400	10	5.80
3 Lateral jumper bars		PC13-10	1SNA173510R2000	10	26.00
4 Test sockets		AL2	1SNA163043R2100	50	0.90
		AL3	1SNA163261R0000	50	1.20
		AL4-M3	1SNA206721R0100	50	1.10
5 Test plugs	Black ■	FC2	1SNA007865R2600	100	
	White □	FC4	1SNA167860R0100	10	10.00
6 Fuses		FU633	1SNA168556R0500	10	
			1SNA168558R1700	10	
			1SNA168560R1500	10	
7 Assembly rods		TGA13	1SNA168564R0500	10	
			1SNA168565R0600	10	
			1SNA168566R0700	10	
8 Spring retaining rings		ANT	1SNA168675R1400	10	
9 Terminal block markers	White □	RC1010	1SNA238000R1600	1	1.30

Complete list of accessories is indicated in the terminal block datasheet. Some accessories such as jumper bars may modify the terminal block's ratings: complete information in the accessories catalogue pages.

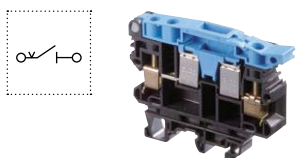
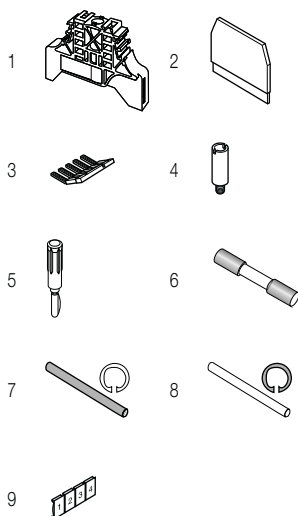

Disconnect screw clamp terminal blocks

Description	Color	Type	Order code	Pkg qty	Weight (1 pce)
Disconnect	Black, blue ■	ML10/13.SN	1SNA199105R2200	20	59.00

All the technical data for UL/CSA standard and dimensions in inches are in *italics*. Technical data valid for copper conductors only.

ML10/13.SF screw clamp terminal blocks

For 6.3 x 25 and 6.3 x 32 fuses - with blown fuse indicator

13 mm 0.512 in spacing

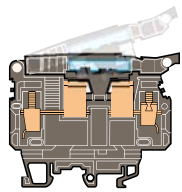

13 mm 0.512 in spacing

With blown fuse indicator by neon

Ordering details

Description	Color	Type	Order code	Pkg qty	Weight (1 pce) g
Fuse With blown fuse indicator by neon 110-230 V AC	Black ■	ML10/13.SFL	1SNA199168R0000	20	54.00

Main technical data	IEC	UL	CSA	Leakage current :
Rated voltage	800 V	600 V	600 V	110 V : < 0.5 mA
Impulse withstand voltage	8000 V			230 V : < 0.7 mA
Protection	NEMA			

CE	RoHS	UR	CSA	Gost R															
CE	RoHS	UR	CSA	Gost R															

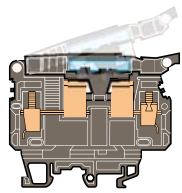

13 mm 0.512 in spacing

With blown fuse indicator by LED

Ordering details

Description	Color	Type	Order code	Pkg qty	Weight (1 pce) g
Fuse With blown fuse indicator by LED 24 V AC/DC	Black ■	ML10/13.SFD	1SNA199166R2600	20	54.00

Main technical data	IEC	UL	CSA	Leakage current :
Rated voltage	800 V	600 V	600 V	24 V : < 4.5 mA
Impulse withstand voltage	8000 V			
Protection	NEMA			

CE	RoHS	UR	CSA	Gost R															
CE	RoHS	UR	CSA	Gost R															

All the technical data for UL/CSA standard and dimensions in inches are in italic.
 Technical data valid for copper conductors only.

ML10/13.SN screw clamp terminal blocks

Disconnect with lever - 13 mm 0.512 in spacing



10 mm²
10 AWG

2

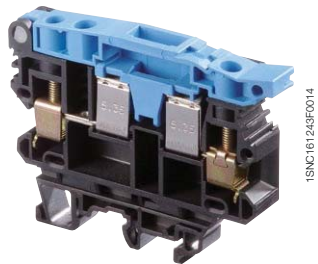

1SNC161245P0014

ML10/13.SN

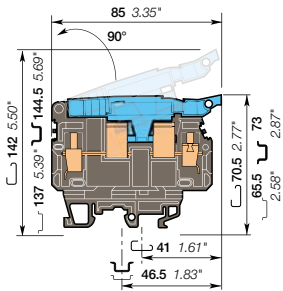

13 mm 0.512 in spacing

Description

- Simplify the disconnect operations for the disconnect terminal blocks installed next to fuse terminal blocks ML10/13.SF...
- With the same profile as ML10/13.SF, the ML10/13.SN disconnect lever is easily operated by hand and the wiring of the alternated disconnect and fuse circuits is easier,
- Link bar for lever included in terminal block.

Ordering details

Description	Color	Type	Order code	Pkg qty	Weight (1 pce) g
Disconnect With test sockets DIA 2 mm 0.079 in	Black, blue	ML10/13.SN	1SNA199105R2200	20	59.00

Main technical data

Connecting capacity		IEC	UL	CSA	Mounting instructions	
1 conductor per clamp	Rigid - Solid / Stranded	0.5-16 mm ²	22-10 AWG	22-8 AWG	Rail	G32, TH 35-7.5, TH 35-15
	Flexible with insulated ferrule Gauge	0.5-10 mm ²			Wire stripping length	12 mm 0.472 in
		A6			Tool	Flat screwdriver Ø 5.5 mm Ø 0.217 in
Rated current / Rated cross section		16 A / 10 mm ²	25 A / 10 AWG	25 A / 8 AWG	Torque	1.2 - 1.4 N.m 10.6 - 12.3 lb.in
Rated short-time withstand current (1s)		180 A				
Rated voltage		800 V	600 V	600 V		
Impulse withstand voltage		8000 V				
Protection			NEMA			

The connecting capacity data for one Rigid - Solid / Stranded - Flexible conductor (when applicable) is a mandatory information required by IEC, UL and CSA standards. All other data are provided as supplementary information only. For more details, please consult our CB, UL or CSA certificates and technical datasheet available on <http://www.abb.com>

CE	RoHS	UL	CSA	Gost R
CE	RoHS	UL	CSA	Gost R

Notes

A: Use of the BJS requires the user to cut out the partition.

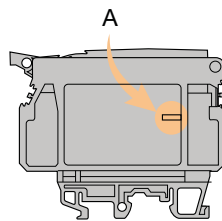

Accessories

Description	Color	Type	Order code	Pkg qty	Weight (1 pce) g
1 End stops	Grey	BAM2	1SNA206351R1600	50	12.00
		BADL	1SNA399903R0200	50	4.70
2 End sections	Black	FEM13U	1SNA199635R2400	10	5.80
3 Lateral jumper bars		PC13-10	1SNA173510R2000	10	26.00
4 Test sockets		AL2	1SNA163043R2100	50	0.90
		AL3	1SNA163261R0000	50	1.20
		AL4-M3	1SNA206721R0100	50	1.10
5 Test plugs	Black	FC2	1SNA007865R2600	100	
	White	FC4	1SNA167860R0100	10	
6 Assembly rods		2 poles	1SNA168564R0500	10	
		3 poles	1SNA168565R0600	10	
		4 poles	1SNA168566R0700	10	
7 Spring retaining rings		ANT	1SNA168675R1400	10	
8 Terminal block markers	Blank card	White	RC1010	1	1.30

Complete list of accessories is indicated in the terminal block datasheet.

Some accessories such as jumper bars may modify the terminal block's ratings: complete information in the accessories catalogue pages.

All the technical data for UL/CSA standard and dimensions in inches are in italic.

Technical data valid for copper conductors only.

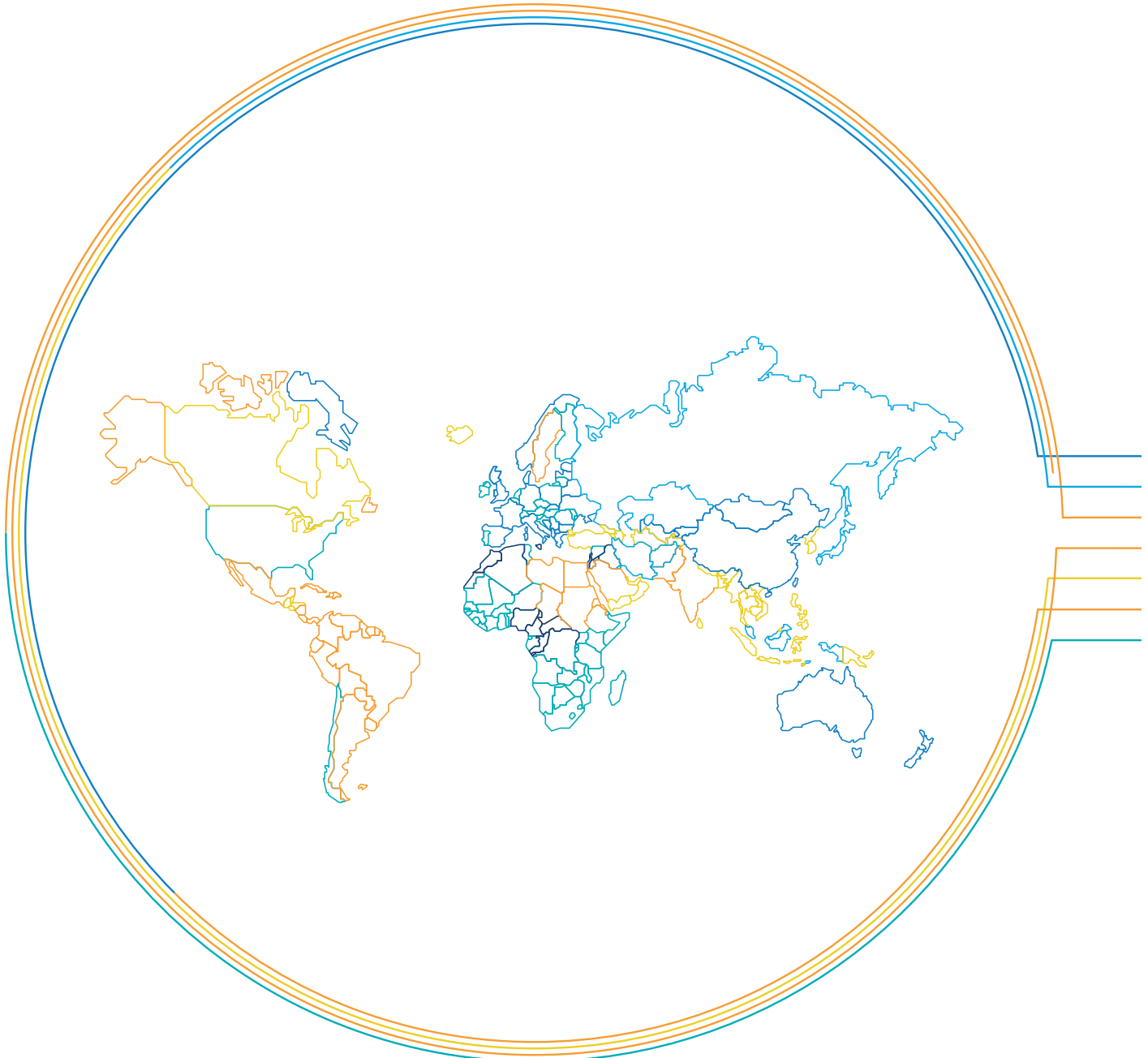



SNA series, terminal blocks

Spring clamp technology

Overview

92

Feed-through

2.5 mm ² / 12 AWG	D2.5/5.2L	2 connections	93
	D2.5/5.3L	3 connections	94
	D2.5/5.4L	4 connections	95
	D2.5/5.1.3L	Angled block with 3 connections	96
	D2.5/5.1.4L	Angled block with 4 connections	97
4 mm ² / 10 AWG	D4/6.2L	2 connections	98
	D4/6.3L	3 connections	99
	D4/6.4L	4 connections	100
6 mm ² / 8 AWG	D6/8.2L	2 connections	101
	D6/8.3L	3 connections	102
10 mm ² / 6 AWG	D10/10.1.2L	2 connections	103
	D10/10.3L	3 connections	104
16 mm ² / 6 AWG	D16/12.2L	2 connections	105
	D16/12.3L	3 connections	106
35 mm ² / 2 AWG	D35/16.2L	2 connections	107

Ground

2.5 mm ² / 12 AWG	D2.5/5.P.2L	2 connections	108
	D2.5/5.P.3L	3 connections	109
	D2.5/5.P.4L	4 connections	110
	D2.5/5.P.I.3L	3 connections	111
	D2.5/5.P.I.4L	4 connections	112
4 mm ² / 10 AWG	D4/6.P.2L	2 connections	113
	D4/6.P.3L	3 connections	114
	D4/6.P.4L	4 connections	115
6 mm ² / 8 AWG	D6/8.P.2L	2 connections	116
	D6/8.P.3L	3 connections	117
10 mm ² / 6 AWG	D10/10.1.P.2L	2 connections	118
	D10/10.P.3L	3 connections	119
16 mm ² / 6 AWG	D16/12.P.2L	2 connections	120
	D16/12.P.3L	3 connections	121
35 mm ² / 2 AWG	D35/16.P.2L	2 connections	122

Double deck

2.5 mm ² / 12 AWG	D2.5/5.D2.L		123
------------------------------	--------------------	--	-----

Triple deck

2.5 mm ² / 12 AWG	D2.5/5.T3.L		124
	D2.5/5.T3.P.L	Triple deck + ground	125
	D2.5/5.T1.L	6 common connections	126
	D2.5/5.T1.P.L	7 ground connections	127

Disconnect

2.5 mm ² / 12 AWG	D2.5/5.SNBT.2L	2 connections	128
	D2.5/5.SNBT.4L	4 connections	129

For 5x20 and 5x25 mm fuses (0.197x0.787 in and 0.197x0.984 in)

2.5 mm ² / 12 AWG	D2.5/8.SF.2L	Fuse holders	130
	D2.5/8.SNT.2L	Disconnect - profile aligned with D2.5/8.SF.2L	132



SNA series, terminal blocks

Spring clamp technology

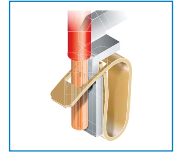

3



Feed-through

Section											
IEC	UL/CSA										
2.5 mm ²	12 AWG	D2.5/5.2L	5 mm 0.197 in	D2.5/5.3L	5 mm 0.197 in	D2.5/5.4L	5 mm 0.197 in	D2.5/5.1.3L	5 mm 0.197 in	D2.5/5.1.4L	5 mm 0.197 in
4 mm ²	10 AWG	D4/6.2L	6 mm 0.236 in	D4/6.3L	6 mm 0.236 in	D4/6.4L	6 mm 0.236 in				
6 mm ²	8 AWG	D6/8.2L	8 mm 0.315 in	D6/8.3L	8 mm 0.315 in						
10 mm ²	6 AWG	D10/10.1.2L	10 mm 0.394 in	D10/10.3L	10 mm 0.394 in						
16 mm ²	6 AWG	D16/12.2L	12 mm 0.472 in	D16/12.3L	12 mm 0.472 in						
35 mm ²	2 AWG	D35/16.2L	16 mm 0.630 in								



Ground

Section											
IEC	UL/CSA										
2.5 mm ²	12 AWG	D2.5/5.P.2L	5 mm 0.197 in	D2.5/5.P.3L	5 mm 0.197 in	D2.5/5.P.4L	5 mm 0.197 in	D2.5/5.I.P.3L	5 mm 0.197 in	D2.5/5.I.P.4L	5 mm 0.197 in
4 mm ²	10 AWG	D4/6.P.2L	6 mm 0.236 in	D4/6.P.3L	6 mm 0.236 in	D4/6.P.4L	6 mm 0.236 in				
6 mm ²	8 AWG	D6/8.P.2L	8 mm 0.315 in	D6/8.P.3L	8 mm 0.315 in						
10 mm ²	6 AWG	D10/10.1.P.2L	10 mm 0.394 in	D10/10.P.3L	10 mm 0.394 in						
16 mm ²	6 AWG	D16/12.P.2L	12 mm 0.472 in	D16/12.P.3L	12 mm 0.472 in						
35 mm ²	2 AWG	D35/16.P.2L	16 mm 0.630 in								



Double deck Triple deck Triple deck + ground Disconnect For 5 x 20 and 5 x 25 mm fuses (0.197" x 0.787" and 0.197" x 0.984")

Section											
IEC	UL/CSA										
2.5 mm ²	12 AWG	D2.5/5.D.2L	5 mm 0.197 in	D2.5/5.T.L	5 mm 0.197 in	D2.5/5.T3.PL	5 mm 0.197 in	D2.5/5.T1.PL	5 mm 0.197 in	D2.5/5.SNBT...	5 mm 0.197 in
										D2.5/8.SF.2L	5 mm 0.197 in
										D2.5/8.SNT.2L	5 mm 0.197 in

All the technical data for UL/CSA standard and dimensions in inches are in *italics*.

- Terminal - Hole for testing or jumpering - Testing point - Fuse holder - Blown-fuse indicator - Ground connection, linked to the DIN rail
- Interconnection between decks - Disconnect function

D2.5/5.2L spring terminal blocks

Feed-through with 2 connections - 5 mm 0.197 in spacing

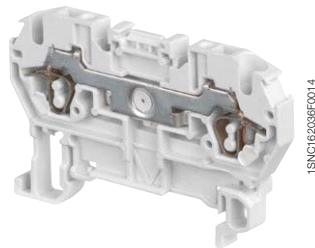

D2.5/5.2L

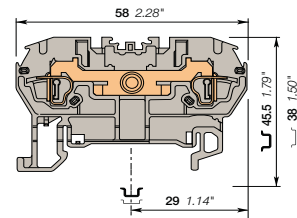

5 mm 0.197 in spacing

Description

- Easy to access thanks to its front wiring entry,
- Clamping contact pressure non dependent on the operator and automatic creeping compensation,
- Numerous built-in functions: double jumpering system, clearly visible top marker, test sockets, etc,
- Functional through ergonomic design (alignment).

Ordering details

Description	Color	Type	Order code	Pkg qty	Weight (1 pce) g
Feed-through 2 connections	Grey	D2.5/5.2L	1SNA290021R2700	50	6.00
	Blue	D2.5/5.N.2L	1SNA290023R2100	50	6.00
	Orange	D2.5/5.2L	1SNA290022R2000	50	6.00
	Yellow	D2.5/5.2L	1SNA290027R2500	50	6.00
	Green	D2.5/5.2L	1SNA290028R0600	50	6.00
	Red	D2.5/5.2L	1SNA290024R2200	50	6.00
	Purple	D2.5/5.2L	1SNA290465R0100	50	6.00
	Brown	D2.5/5.2L	1SNA290464R0000	50	6.00
	White	D2.5/5.2L	1SNA290025R2300	50	6.00
	Black	D2.5/5.2L	1SNA290026R2400	50	6.00

Main technical data

Connecting capacity		IEC	UL	CSA	Mounting instructions	
1 conductor per clamp	Rigid - Solid / Stranded	0.12-4 mm ²	26-12 AWG	26-12 AWG	Rail	TH 35-7.5, TH 35-15
	Flexible with non insulated ferrule	0.12-2.5 mm ²			Wire stripping length	9.5 mm 0.37 in
	with insulated ferrule				Tool	Flat screwdriver Ø 3.5 mm Ø 0.138 in
Gauge	A2					
Rated current / Rated cross section		24 A / 2.5 mm ²	15 A / 12 AWG	15 A / 12 AWG		
Rated short-time withstand current (1s)		300 A				
Rated voltage		800 V	600 V	600 V		
Impulse withstand voltage		8000 V				
Protection		IP20	NEMA 1			

The connecting capacity data for one Rigid - Solid / Stranded - Flexible conductor (when applicable) is a mandatory information required by IEC, UL and CSA standards. All other data are provided as supplementary information only. For more details, please consult our CB, UL or CSA certificates and technical datasheet available on <http://www.abb.com>

RoHS	RoHS	UL	UL	CSA	CSA	PC	PC	Gost R	Gost R
------	------	----	----	-----	-----	----	----	--------	--------

Accessories

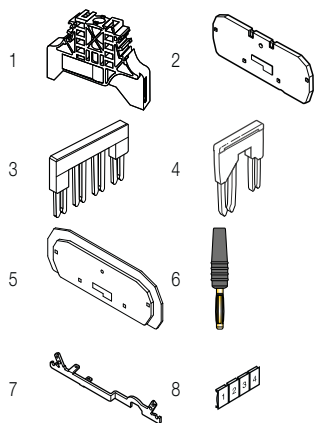

Description	Color	Type	Order code	Pkg qty	Weight (1 pce) g	
1 End stops	Grey	BADL	1SNA399903R0200	50	4.70	
		BAM2	1SNA206351R1600	50	12.00	
2 End sections	Grey	FED5.2L	1SNA291061R2400	20	2.00	
3 Jumper bars	Orange	2 poles	BJDL5-2	1SNA291102R2300	50	1.00
		3 poles	BJDL5-3	1SNA291103R2400	50	0.70
		4 poles	BJDL5-4	1SNA291104R2500	50	0.80
		5 poles	BJDL5-5	1SNA291105R2600	20	0.90
		10 poles	BJDL5-10	1SNA291110R2600	20	1.20
		4 Cross spacing jumpers	Orange	5 mm 0.200 in - 6 mm 0.236 in	BJDPL5.6-2	1SNA291150R0600
5 mm 0.200 in - 8 mm 0.315 in	BJDPL5.8-2			1SNA291160R0000	20	1.65
5 mm 0.200 in - 10 mm 0.400 in	BJDPL5.10-2			1SNA291480R2200	20	0.50
5 Circuit separators	Orange	SCD5.2L	1SNA291352R0400	20	2.20	
6 Test plugs	Black	FC2.MC	1SNA107239R0300	20	1.00	
7 Shield connectors	Black	CBD5.2L	1SNA291077R2400	50	2.00	
8 Terminal block markers	White	RC510	1SNA231000R0700	1	5.20	

Complete list of accessories is indicated in the terminal block datasheet. Some accessories such as jumper bars may modify the terminal block's ratings: complete information in the accessories catalogue pages.

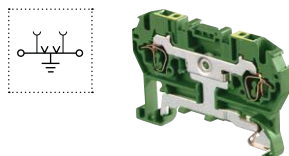

Ground spring terminal blocks

Description	Color	Type	Order code	Pkg qty	Weight (1 pce) g
Ground Screwless rail connection	Green-yellow	D2.5/5.P.2L	1SNA290029R0700	50	9.00

All the technical data for UL/CSA standard and dimensions in inches are in *italics*. Technical data valid for copper conductors only.

D2.5/5.3L spring terminal blocks

Feed-through with 3 connections - 5 mm 0.197 in spacing



D2.5/5.3L

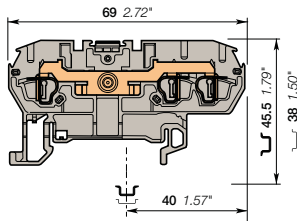

5 mm 0.197 in spacing

Description

- Easy to access thanks to its front wiring entry,
- Clamping contact pressure non dependent on the operator and automatic creeping compensation,
- Numerous built-in functions: double jumper system, clearly visible top marker, test sockets, etc,
- Functional through ergonomic design (alignment).

Ordering details

Description	Color	Type	Order code	Pkg qty	Weight (1 pce) g
Feed-through 3 connections	Grey	D2.5/5.3L	1SNA290031R2100	50	7.00
	Blue	D2.5/5.N.3L	1SNA290033R2300	50	7.00
	Orange	D2.5/5.3L	1SNA290032R2200	50	7.00
	Yellow	D2.5/5.3L	1SNA290037R2700	50	7.00
	Green	D2.5/5.3L	1SNA290038R0000	50	7.00
	Red	D2.5/5.3L	1SNA290034R2400	50	7.00
	White	D2.5/5.3L	1SNA290035R2500	50	7.00
	Black	D2.5/5.3L	1SNA290036R2600	50	7.00

Main technical data

Connecting capacity		IEC	UL	CSA	Mounting instructions	
1 conductor per clamp	Rigid - Solid / Stranded	0.12-4 mm ²	26-12 AWG	26-12 AWG	Rail	TH 35-7.5, TH 35-15
	Flexible with non insulated ferrule	0.12-2.5 mm ²			Wire stripping length	9.5 mm 0.37 in
	with insulated ferrule				Tool	Flat screwdriver Ø 3.5 mm Ø 0.138 in
	Gauge	A2				
Rated current / Rated cross section		24 A / 2.5 mm ²	15 A / 12 AWG	15 A / 12 AWG		
Rated short-time withstand current (1s)		300 A				
Rated voltage		800 V	600 V	600 V		
Impulse withstand voltage		8000 V				
Protection		IP20	NEMA 1			

The connecting capacity data for one Rigid - Solid / Stranded - Flexible conductor (when applicable) is a mandatory information required by IEC, UL and CSA standards. All other data are provided as supplementary information only. For more details, please consult our CB, UL or CSA certificates and technical datasheet available on <http://www.abb.com>



Accessories

Description	Color	Type	Order code	Pkg qty	Weight (1 pce) g	
1 End stops	Grey	BADL	1SNA399903R0200	50	4.70	
		BAM2	1SNA206351R1600	50	12.00	
2 End sections	Grey	FED5.3L	1SNA291051R2200	20	1.90	
3 Jumper bars	Orange	2 poles 24 A	BJDL5-2	1SNA291102R2300	50	1.00
		3 poles	BJDL5-3	1SNA291103R2400	50	0.70
		4 poles	BJDL5-4	1SNA291104R2500	50	0.80
		5 poles	BJDL5-5	1SNA291105R2600	20	0.90
		10 poles	BJDL5-10	1SNA291110R2600	20	1.20
		5 mm 0.200 in - 6 mm 0.236 in	BJDPL5.6-2	1SNA291150R0600	20	0.20
4 Cross spacing jumpers	Orange	5 mm 0.200 in - 8 mm 0.315 in	BJDPL5.8-2	1SNA291160R0000	20	1.65
		5 mm 0.200 in - 10 mm 0.400 in	BJDPL5.10-2	1SNA291480R2200	20	0.50
5 Circuit separators	Orange	SCD5.3L	1SNA291362R0600	20	2.60	
6 Test plugs	Black	FC2.MC	1SNA107239R0300	20	1.00	
7 Terminal block markers	White	RC510	1SNA231000R0700	1	5.20	

Complete list of accessories is indicated in the terminal block datasheet. Some accessories such as jumper bars may modify the terminal block's ratings: complete information in the accessories catalogue pages.

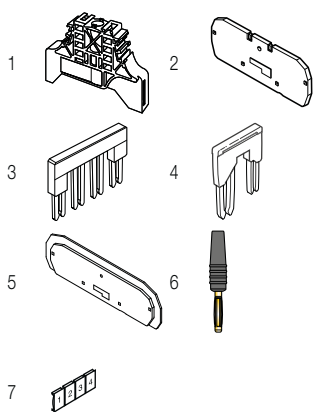

Ground spring terminal blocks

Description	Color	Type	Order code	Pkg qty	Weight (1 pce) g
Ground Screwless rail connection	Green-yellow	D2.5/5.P.3L	1SNA290039R0100	50	11.00

All the technical data for UL/CSA standard and dimensions in inches are in italic. Technical data valid for copper conductors only.

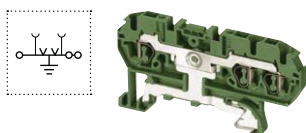

D2.5/5.4L spring terminal blocks

Feed-through with 4 connections - 5 mm 0.197 in spacing

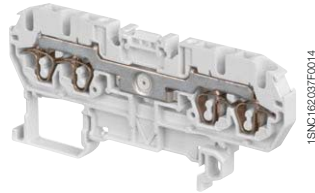

D2.5/5.4L

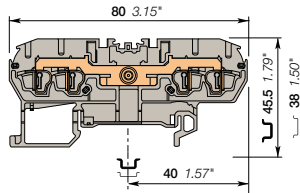

5 mm 0.197 in spacing

Description

- Easy to access thanks to its front wiring entry,
- Clamping contact pressure non dependent on the operator and automatic creeping compensation,
- Numerous built-in functions: double jumper system, clearly visible top marker, test sockets, etc,
- Functional through ergonomic design (alignment).

Ordering details

Description	Color	Type	Order code	Pkg qty	Weight (1 pce) g
Feed-through 4 connections	Grey	D2.5/5.4L	1SNA290011R2500	50	8.00
	Blue	D2.5/5.N.4L	1SNA290013R2700	50	8.00
	Orange	D2.5/5.4L	1SNA290012R2600	50	8.00
	Yellow	D2.5/5.4L	1SNA290017R2300	50	8.00
	Green	D2.5/5.4L	1SNA290018R0400	50	8.00
	Red	D2.5/5.4L	1SNA290014R2000	50	8.00
	White	D2.5/5.4L	1SNA290015R2100	50	8.00
	Black	D2.5/5.4L	1SNA290016R2200	50	8.00

Main technical data

Connecting capacity		IEC	UL	CSA	Mounting instructions	
1 conductor per clamp	Rigid - Solid / Stranded	0.12-4 mm ²	26-12 AWG	26-12 AWG	Rail	TH 35-7.5, TH 35-15
	Flexible with non insulated ferrule	0.12-2.5 mm ²			Wire stripping length	9.5 mm 0.37 in
	with insulated ferrule				Tool	Flat screwdriver Ø 3.5 mm Ø 0.138 in
	Gauge	A2				
Rated current / Rated cross section		24 A / 2.5 mm ²	15 A / 12 AWG	15 A / 12 AWG		
Rated short-time withstand current (1s)		300 A				
Rated voltage		800 V	600 V	600 V		
Impulse withstand voltage		8000 V				
Protection		IP20	NEMA 1			

The connecting capacity data for one Rigid - Solid / Stranded - Flexible conductor (when applicable) is a mandatory information required by IEC, UL and CSA standards. All other data are provided as supplementary information only. For more details, please consult our CB, UL or CSA certificates and technical datasheet available on <http://www.abb.com>



Accessories

Description	Color	Type	Order code	Pkg qty	Weight (1 pce) g	
1 End stops	Grey	BADL	1SNA399903R0200	50	4.70	
	Grey	BAM2	1SNA206351R1600	50	12.00	
2 End sections	Grey	FED5.4L	1SNA291041R2000	20	2.20	
3 Jumper bars	Orange	2 poles	BJDL5-2	1SNA291102R2300	50	1.00
		3 poles	BJDL5-3	1SNA291103R2400	50	0.70
		4 poles	BJDL5-4	1SNA291104R2500	50	0.80
		5 poles	BJDL5-5	1SNA291105R2600	20	0.90
		10 poles	BJDL5-10	1SNA291110R2600	20	1.20
4 Cross spacing jumpers	Orange	5 mm 0.200 in - 6 mm 0.236 in	BJDPL5.6-2	1SNA291150R0600	20	0.20
		5 mm 0.200 in - 8 mm 0.315 in	BJDPL5.8-2	1SNA291160R0000	20	1.65
		5 mm 0.200 in - 10 mm 0.400 in	BJDPL5.10-2	1SNA291480R2200	20	0.50
5 Circuit separators	Orange	SCD5.4L	1SNA291372R0000	20	2.90	
6 Test plugs	Black	FC2.MC	1SNA107239R0300	20	1.00	
7 Terminal block markers	White	RC510	1SNA231000R0700	1	5.20	

Complete list of accessories is indicated in the terminal block datasheet. Some accessories such as jumper bars may modify the terminal block's ratings: complete information in the accessories catalogue pages.

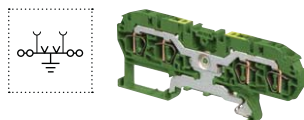
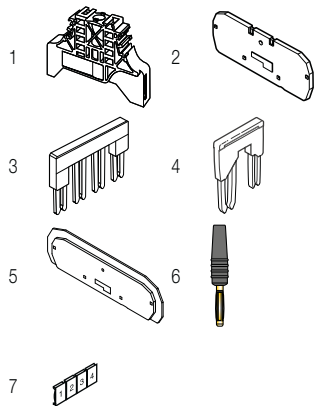

Ground spring terminal blocks

Description	Color	Type	Order code	Pkg qty	Weight (1 pce) g
Ground	Green-yellow	D2.5/5.P.4L	1SNA290019R0500	50	12.00

All the technical data for UL/CSA standard and dimensions in inches are in *italics*. Technical data valid for copper conductors only.

D2.5/5.1.3L spring terminal blocks

Feed-through with 3 connections - 5 mm 0.197 in spacing



2.5 mm²
12 AWG

Description

- Easy to access thanks to its front wiring entry,
- Clamping contact pressure non dependent on the operator and automatic creeping compensation,
- Numerous built-in functions: double jumper system, clearly visible top marker, test sockets, etc.

Ordering details

Description	Color	Type	Order code	Pkg qty	Weight (1 pce) g
Feed-through 3 connections	Grey	D2.5/5.1.3L	1SNA399068R1700	50	8.00
	Blue	D2.5/5.1.N.3L	1SNA399067R0600	50	8.00
	Orange	D2.5/5.1.3L	1SNA399260R2000	50	8.00
	Yellow	D2.5/5.1.3L	1SNA400219R1100	50	8.00

Main technical data

Connecting capacity	IEC	UL	CSA	Mounting instructions	
1 conductor per clamp	Rigid - Solid / Stranded	0.12-4 mm ²	26-12 AWG	Rail	TH 35-7.5, TH 35-15
	Flexible with non insulated ferrule	0.12-2.5 mm ²		Wire stripping length	9.5 mm 0.37 in
	with insulated ferrule			Tool	Flat screwdriver Ø 3.5 mm Ø 0.138 in
	Gauge	A2			
Rated current / Rated cross section	24 A / 2.5 mm ²	20 A / 12 AWG	15 A / 14 AWG		
Rated short-time withstand current (1s)	300 A				
Rated voltage	800 V	600 V	600 V		
Impulse withstand voltage	8000 V				
Protection	IP20	NEMA 1			

The connecting capacity data for one Rigid - Solid / Stranded - Flexible conductor (when applicable) is a mandatory information required by IEC, UL and CSA standards. All other data are provided as supplementary information only. For more details, please consult our CB, UL or CSA certificates and technical datasheet available on <http://www.abb.com>

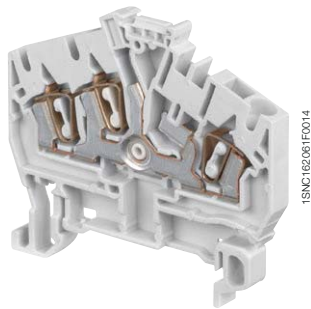

D2.5/5.1.3L

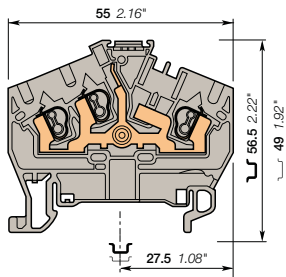

5 mm 0.197 in spacing

Accessories

Description	Color	Type	Order code	Pkg qty	Weight (1 pce) g	
1 End stops	Grey	BADL	1SNA399903R0200	50	4.70	
		BAM2	1SNA206351R1600	50	12.00	
2 End sections	Grey	FED5.1.3L	1SNA290311R0600	20	2.10	
3 Jumper bars	Orange	2 poles 24 A	BJDL5-2	1SNA291102R2300	50	1.00
		3 poles	BJDL5-3	1SNA291103R2400	50	0.70
		4 poles	BJDL5-4	1SNA291104R2500	50	0.80
		5 poles	BJDL5-5	1SNA291105R2600	20	0.90
		10 poles	BJDL5-10	1SNA291110R2600	20	1.20
4 Test plugs	Black	FC2.MC	1SNA107239R0300	20	1.00	
5 Shield connectors		CBD5.2L	1SNA291077R2400	50	2.00	
6 Terminal block markers	White	RC510	1SNA231000R0700	1	5.20	

Complete list of accessories is indicated in the terminal block datasheet. Some accessories such as jumper bars may modify the terminal block's ratings: complete information in the accessories catalogue pages.

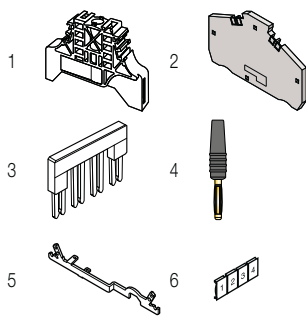

Ground spring terminal blocks

Description	Color	Type	Order code	Pkg qty	Weight (1 pce) g
Ground	Green-yellow	D2.5/5.1.P.3L	1SNA399072R0300	50	11.00

All the technical data for UL/CSA standard and dimensions in inches are in *italics*. Technical data valid for copper conductors only.

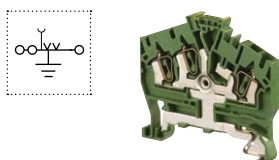

D2.5/5.I.4L spring terminal blocks

Feed-through with 4 connections - 5 mm 0.197 in spacing

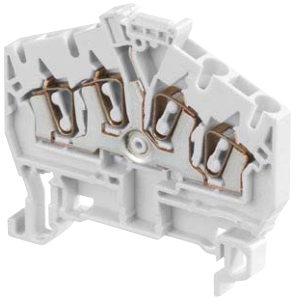

D2.5/5.I.4L

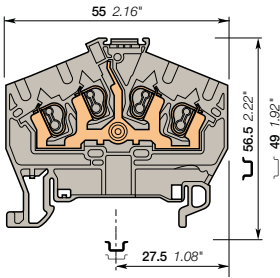

5 mm 0.197 in spacing

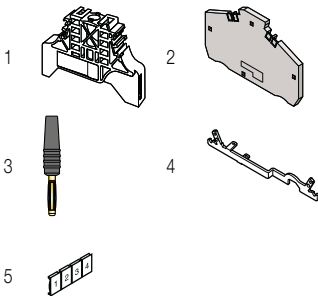

Description

- Easy to access thanks to its front wiring entry,
- Clamping contact pressure non dependent on the operator and automatic creeping compensation,
- Numerous built-in functions: clearly visible top marker, test sockets, etc.

Ordering details

Description	Color	Type	Order code	Pkg qty	Weight (1 pce) g
Feed-through 4 connections	Grey	D2.5/5.I.4L	1SNA399071R0200	50	9.00
	Blue	D2.5/5.I.N.4L	1SNA399070R1500	50	9.00
	Orange	D2.5/5.I.4L	1SNA399270R2200	50	9.00

Main technical data

Connecting capacity		IEC	UL	CSA	Mounting instructions	
1 conductor per clamp	Rigid - Solid / Stranded	0.12-4 mm²	26-12 AWG	26-14 AWG	Rail	TH 35-7.5, TH 35-15
	Flexible with non insulated ferrule	0.12-2.5 mm²			Wire stripping length	9.5 mm 0.37 in
	with insulated ferrule				Tool	Flat screwdriver Ø 3.5 mm Ø 0.138 in
	Gauge	A2				
Rated current / Rated cross section		24 A / 2.5 mm²	20 A / 12 AWG	15 A / 14 AWG		
Rated short-time withstand current (1s)		300 A				
Rated voltage		800 V	600 V	600 V		
Impulse withstand voltage		8000 V				
Protection		IP20	NEMA 1			

The connecting capacity data for one Rigid - Solid / Stranded - Flexible conductor (when applicable) is a mandatory information required by IEC, UL and CSA standards. All other data are provided as supplementary information only. For more details, please consult our CB, UL or CSA certificates and technical datasheet available on <http://www.abb.com>



Accessories

Description	Color	Type	Order code	Pkg qty	Weight (1 pce) g
1 End stops	Grey	BADL	1SNA399903R0200	50	4.70
		BAM2	1SNA206351R1600	50	12.00
2 End sections	Grey	FED5.I.3L	1SNA290311R0600	20	2.10
3 Test plugs	Black	FC2.MC	1SNA107239R0300	20	1.00
4 Shield connectors		CBD5.2L	1SNA291077R2400	50	2.00
5 Terminal block markers	White	RC510	1SNA231000R0700	1	5.20

Complete list of accessories is indicated in the terminal block datasheet. Some accessories such as jumper bars may modify the terminal block's ratings: complete information in the accessories catalogue pages.

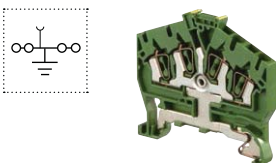

Ground spring terminal blocks

Description	Color	Type	Order code	Pkg qty	Weight (1 pce) g
Ground	Green-yellow	D2.5/5.I.P.4L	1SNA399073R0400	50	12.00

All the technical data for UL/CSA standard and dimensions in inches are in *italics*. Technical data valid for copper conductors only.

D4/6.2L spring terminal blocks

Feed-through with 2 connections - 6 mm 0.236 in spacing

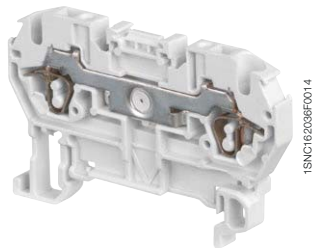

1SNC162006F0014

D4/6.2L

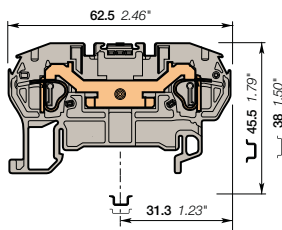

6 mm 0.236 in spacing

Description

- Easy to access thanks to its front wiring entry,
- Clamping contact pressure non dependent on the operator and automatic creeping compensation,
- Numerous built-in functions: double jumper system, clearly visible top marker, test sockets, etc,
- Functional through ergonomic design (alignment).

Ordering details

Description	Color	Type	Order code	Pkg qty	Weight (1 pce) g
Feed-through 2 connections	Grey	D4/6.2L	1SNA290061R0700	50	8.00
	Blue	D4/6.N.2L	1SNA290063R0100	50	8.00
	Orange	D4/6.2L	1SNA290062R0000	50	8.00
	Yellow	D4/6.2L	1SNA290067R0500	50	8.00
	Red	D4/6.2L	1SNA290064R0200	50	8.00
	Black	D4/6.2L	1SNA290066R0400	50	8.00

Main technical data

Connecting capacity	IEC	UL	CSA	Mounting instructions
1 conductor per clamp	Rigid - Solid / Stranded	0.2-6 mm ²	24-10 AWG	24-10 AWG
	Flexible with non insulated ferrule with insulated ferrule Gauge	0.2-4 mm ²		
		A4		
Rated current / Rated cross section	32 A / 4 mm ²	25 A / 10 AWG	25 A / 10 AWG	
Rated short-time withstand current (1s)	480 A			
Rated voltage	800 V	600 V	600 V	
Impulse withstand voltage	8000 V			
Protection	IP20	NEMA 1		

Mounting instructions

Rail		TH 35-7.5, TH 35-15
Wire stripping length		11 mm 0.43 in
Tool		Flat screwdriver Ø 4 mm Ø 0.157 in

The connecting capacity data for one Rigid - Solid / Stranded - Flexible conductor (when applicable) is a mandatory information required by IEC, UL and CSA standards.

All other data are provided as supplementary information only. For more details, please consult our CB, UL or CSA certificates and technical datasheet available on <http://www.abb.com>

RoHS		RoHS
UL		UL
CSA		CSA
Gost R		Gost R

Accessories

Description	Color	Type	Order code	Pkg qty	Weight (1 pce) g	
1 End stops	Grey	BADL	1SNA399903R0200	50	4.70	
		BAM2	1SNA206351R1600	50	12.00	
2 End sections	Grey	FED5.2L	1SNA291061R2400	20	2.00	
3 Jumper bars	Orange	2 poles	BJDL6-2	1SNA291128R2400	50	0.30
		3 poles	BJDL6-3	1SNA291129R2500	50	0.40
		4 poles	BJDL6-4	1SNA291194R1700	50	0.50
		5 poles	BJDL6-5	1SNA291195R1000	20	0.60
		6 poles	BJDL6-6	1SNA291196R1000	20	0.60
4 Cross spacing jumpers	Orange	5 mm 0.200 in - 6 mm 0.236 in	BJDPL5.6-2	1SNA291150R0600	20	0.20
		6 mm 0.236 in - 8 mm 0.315 in	BJDPL6.8-2	1SNA291170R0200	20	0.20
		6 mm 0.236 in - 10 mm 0.400 in	BJDPL6.10-2	1SNA291482R1000	20	1.00
		6 mm 0.236 in - 12 mm 0.473 in	BJDPL6.12-2	1SNA399613R0600	20	3.10
5 Circuit separators	Orange	SCD5.2L	1SNA291352R0400	20	2.20	
6 Test plugs	Black	FC2.MC	1SNA107239R0300	20	1.00	
7 Terminal block markers	White	RC610	1SNA233000R0100	1	7.50	

Complete list of accessories is indicated in the terminal block datasheet.

Some accessories such as jumper bars may modify the terminal block's ratings: complete information in the accessories catalogue pages.

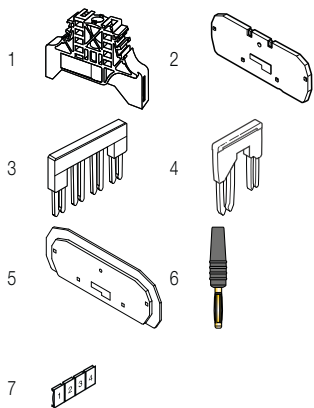

Ground spring terminal blocks

Description	Color	Type	Order code	Pkg qty	Weight (1 pce) g
Ground	Green-yellow	D4/6.P.2L	1SNA290069R1700	50	12.00

All the technical data for UL/CSA standard and dimensions in inches are in *italics*.

Technical data valid for copper conductors only.

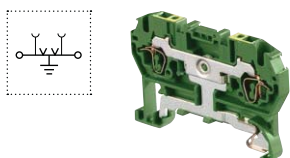

D4/6.3L spring terminal blocks

Feed-through with 3 connections - 6 mm 0.236 in spacing



4 mm²
10 AWG

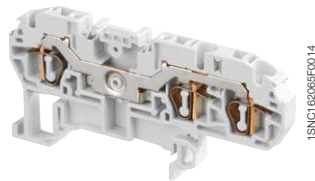

D4/6.3L

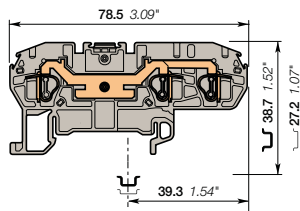

6 mm 0.236 in spacing

Description

- Easy to access thanks to its front wiring entry,
- Clamping contact pressure non dependent on the operator and automatic creeping compensation,
- Numerous built-in functions: double jumper system, clearly visible top marker, test sockets, etc,
- Functional through ergonomic design (alignment).

Ordering details

Description	Color	Type	Order code	Pkg qty	Weight (1 pce) g
Feed-through 3 connections	Grey	D4/6.3L	1SNA290405R0600	50	12.00
	Blue	D4/6.N.3L	1SNA290407R0000	50	12.00
	Orange	D4/6.3L	1SNA290406R0700	50	12.00

Main technical data

Connecting capacity	IEC	UL	CSA
1 conductor per clamp	Rigid - Solid / Stranded	0.2-6 mm ²	24-10 AWG
	Flexible	0.2-4 mm ²	24-10 AWG
	with non insulated ferrule		
	with insulated ferrule		
Gauge	A4		
Rated current / Rated cross section	32 A / 4 mm ²	25 A / 10 AWG	25 A / 10 AWG
Rated short-time withstand current (1s)	480 A		
Rated voltage	800 V	600 V	600 V
Impulse withstand voltage	8000 V		
Protection	IP20	NEMA 1	

Mounting instructions

Rail		TH 35-7.5, TH 35-15
Wire stripping length		11 mm 0.43 in
Tool		Flat screwdriver Ø 4 mm Ø 0.157 in

The connecting capacity data for one Rigid - Solid / Stranded - Flexible conductor (when applicable) is a mandatory information required by IEC, UL and CSA standards. All other data are provided as supplementary information only. For more details, please consult our CB, UL or CSA certificates and technical datasheet available on <http://www.abb.com>



Accessories

Description	Color	Type	Order code	Pkg qty	Weight (1 pce) g	
1 End stops	Grey	BADL	1SNA399903R0200	50	4.70	
		BAM2	1SNA206351R1600	50	12.00	
2 End sections	Grey	FED6.3L	1SNA291694R2400	20	2.50	
3 Jumper bars	Orange	2 poles	BJDL6-2	1SNA291128R2400	50	0.30
		3 poles	BJDL6-3	1SNA291129R2500	50	0.40
		4 poles	BJDL6-4	1SNA291194R1700	50	0.50
		5 poles	BJDL6-5	1SNA291195R1000	20	0.60
		4 Cross spacing jumpers	Orange	BJDPL5.6-2	1SNA291150R0600	20
		6 mm 0.236 in - 8 mm 0.315 in	BJDPL6.8-2	1SNA291170R0200	20	0.20
		6 mm 0.236 in - 10 mm 0.400 in	BJDPL6.10-2	1SNA291482R1000	20	1.00
		6 mm 0.236 in - 12 mm 0.473 in	BJDPL6.12-2	1SNA399613R0600	20	3.10
		5 Test plugs	Black	FC2.MC	1SNA107239R0300	20
6 Terminal block markers	White	RC610	1SNA233000R0100	1	7.50	

Complete list of accessories is indicated in the terminal block datasheet. Some accessories such as jumper bars may modify the terminal block's ratings: complete information in the accessories catalogue pages.

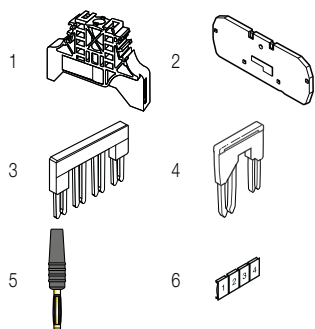

Ground spring terminal blocks

Description	Color	Type	Order code	Pkg qty	Weight (1 pce) g
Ground	Green-yellow	D4/6.P.3L	1SNA290409R1200	50	11.00

All the technical data for UL/CSA standard and dimensions in inches are in *italics*. Technical data valid for copper conductors only.

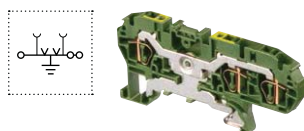

D4/6.4L spring terminal blocks

Feed-through with 4 connections - 6 mm 0.236 in spacing

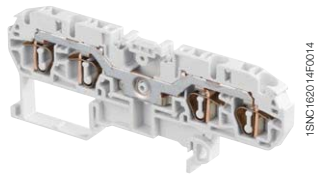

1SNC162014F0014

D4/6.4L

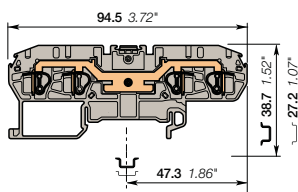

6 mm 0.236 in spacing

Description

- Easy to access thanks to its front wiring entry,
- Clamping contact pressure non dependent on the operator and automatic creeping compensation,
- Numerous built-in functions: double jumper system, clearly visible top marker, test sockets, etc,
- Functional through ergonomic design (alignment).

Ordering details

Description	Color	Type	Order code	Pkg qty	Weight (1 pce) g
Feed-through 4 connections	Grey <input type="checkbox"/>	D4/6.4L	1SNA290410R0600	50	14.00
	Blue <input type="checkbox"/>	D4/6.N.4L	1SNA290412R2400	50	14.00
	Orange <input type="checkbox"/>	D4/6.4L	1SNA290411R2300	50	14.00

Main technical data

Connecting capacity		IEC	UL	CSA	Mounting instructions	
1 conductor per clamp	Rigid - Solid / Stranded	0.2-6 mm ²	24-10 AWG	24-10 AWG	Rail	TH 35-7.5, TH 35-15
	Flexible with non insulated ferrule	0.2-4 mm ²			Wire stripping length	11 mm 0.43 in
	Flexible with insulated ferrule				Tool	Flat screwdriver Ø 4 mm Ø 0.157 in
	Gauge	A4				
Rated current / Rated cross section		32 A / 4 mm ²	25 A / 10 AWG	25 A / 10 AWG		
Rated short-time withstand current (1s)		480 A				
Rated voltage		800 V	600 V	600 V		
Impulse withstand voltage		8000 V				
Protection		IP20	NEMA 1			

The connecting capacity data for one Rigid - Solid / Stranded - Flexible conductor (when applicable) is a mandatory information required by IEC, UL and CSA standards. All other data are provided as supplementary information only. For more details, please consult our CB, UL or CSA certificates and technical datasheet available on <http://www.abb.com>



Accessories

Description	Color	Type	Order code	Pkg qty	Weight (1 pce) g	
1 End stops	Grey <input type="checkbox"/>	BADL	1SNA399903R0200	50	4.70	
		BAM2	1SNA206351R1600	50	12.00	
2 End sections	Grey <input type="checkbox"/>	FED6.4L	1SNA291696R2600	20	2.85	
3 Jumper bars	Orange <input type="checkbox"/>	2 poles	BJDL6-2	1SNA291128R2400	50	0.30
		3 poles	BJDL6-3	1SNA291129R2500	50	0.40
		4 poles	BJDL6-4	1SNA291194R1700	50	0.50
		5 poles	BJDL6-5	1SNA291195R1000	20	0.60
		4 Cross spacing jumpers	Orange <input type="checkbox"/>	BJDPL5.6-2	1SNA291150R0600	20
		BJDPL6.8-2	1SNA291170R0200	20	0.20	
		BJDPL6.10-2	1SNA291482R1000	20	1.00	
		BJDPL6.12-2	1SNA399613R0600	20	3.10	
5 Test plugs	Black <input type="checkbox"/>	FC2.MC	1SNA107239R0300	20	1.00	
6 Terminal block markers	White <input type="checkbox"/>	RC610	1SNA233000R0100	1	7.50	

Complete list of accessories is indicated in the terminal block datasheet. Some accessories such as jumper bars may modify the terminal block's ratings: complete information in the accessories catalogue pages.

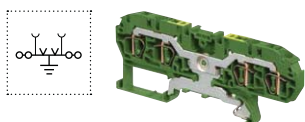
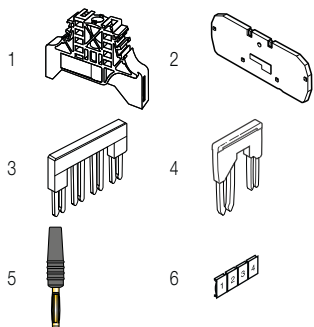

Ground spring terminal blocks

Description	Color	Type	Order code	Pkg qty	Weight (1 pce) g
Ground	Green-yellow <input type="checkbox"/>	D4/6.P.4L	1SNA290414R2600	50	14.00

All the technical data for UL/CSA standard and dimensions in inches are in *italics*. Technical data valid for copper conductors only.

D6/8.2L spring terminal blocks

Feed-through with 2 connections - 8 mm 0.315 in spacing

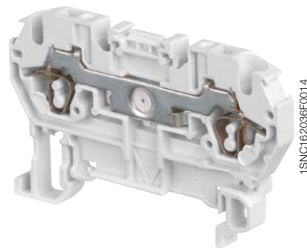
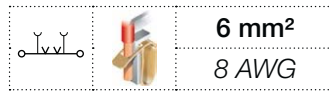

D6/8.2L

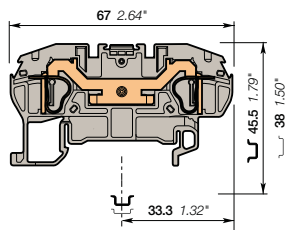

8 mm 0.315 in spacing

Description

- Easy to access thanks to its front wiring entry,
- Clamping contact pressure non dependent on the operator and automatic creeping compensation,
- Numerous built-in functions: double jumper system, clearly visible top marker, test sockets, etc,
- Functional through ergonomic design (alignment).

Ordering details

Description	Color	Type	Order code	Pkg qty	Weight (1 pce) g
Feed-through 2 connections	Grey <input type="checkbox"/>	D6/8.2L	1SNA290081R2400	50	12.00
	Blue <input type="checkbox"/>	D6/8.N.2L	1SNA290083R2600	50	12.00
	Orange <input type="checkbox"/>	D6/8.2L	1SNA290082R2500	50	12.00
	Yellow <input type="checkbox"/>	D6/8.2L	1SNA290087R2200	50	12.00
	Red <input type="checkbox"/>	D6/8.2L	1SNA290084R2700	50	12.00
	Black <input type="checkbox"/>	D6/8.2L	1SNA290086R2100	50	12.00

Main technical data

Connecting capacity		IEC	UL	CSA	Rail	TH 35-7.5, TH 35-15
1 conductor per clamp	Rigid - Solid / Stranded	0.5-10 mm ²	22-8 AWG	22-8 AWG	Wire stripping length	13 mm 0.53 in
	Flexible with non insulated ferrule	0.5-6 mm ²			Tool	Flat screwdriver Ø 5.5 mm Ø 0.217 in
	with insulated ferrule Gauge	A5				
Rated current / Rated cross section		41 A / 6 mm ²	40 A / 8 AWG	40 A / 8 AWG		
Rated short-time withstand current (1s)		720 A				
Rated voltage		800 V	600 V	600 V		
Impulse withstand voltage		8000 V				
Protection		IP20	NEMA 1			

The connecting capacity data for one Rigid - Solid / Stranded - Flexible conductor (when applicable) is a mandatory information required by IEC, UL and CSA standards. All other data are provided as supplementary information only. For more details, please consult our CB, UL or CSA certificates and technical datasheet available on <http://www.abb.com>

RoHS	RoHS	UL	UL	CSA	CSA	PC	PC	Gost R	Gost R
------	------	----	----	-----	-----	----	----	--------	--------

Accessories

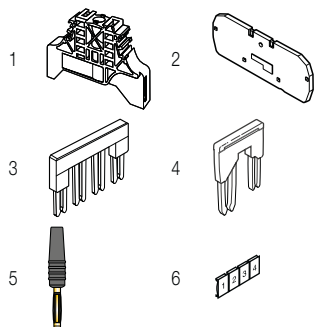

Description	Color	Type	Order code	Pkg qty	Weight (1 pce) g
1 End stops	Grey <input type="checkbox"/>	BADL	1SNA399903R0200	50	4.70
	Grey <input type="checkbox"/>	BAM2	1SNA206351R1600	50	12.00
2 End sections	Grey <input type="checkbox"/>	FED8.2L	1SNA291161R2500	20	2.00
3 Jumper bars	Orange <input type="checkbox"/>	BJDL8-2	1SNA291122R1600	50	0.20
		BJDL8-3	1SNA291123R1700	50	0.40
		BJDL8-4	1SNA291144R2400	50	0.50
		BJDL8-5	1SNA291145R2500	20	3.90
		BJDPL5.8-2	1SNA291160R0000	20	1.65
4 Cross spacing jumpers	Orange <input type="checkbox"/>	BJDPL6.8-2	1SNA291170R0200	20	0.20
		BJDPL8.10-2	1SNA291484R1200	20	1.50
		FC2.MC	1SNA107239R0300	20	1.00
5 Test plugs	Black <input type="checkbox"/>	FC2.MC	1SNA107239R0300	20	1.00
6 Terminal block markers	White <input type="checkbox"/>	RC810	1SNA234000R0200	1	8.20

Complete list of accessories is indicated in the terminal block datasheet. Some accessories such as jumper bars may modify the terminal block's ratings: complete information in the accessories catalogue pages.

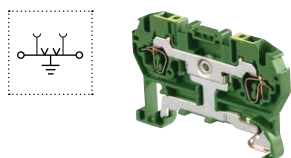

Ground spring terminal blocks

Description	Color	Type	Order code	Pkg qty	Weight (1 pce) g
Ground	Green-yellow <input type="checkbox"/>	D6/8.P.2L	1SNA290089R0400	50	16.00

All the technical data for UL/CSA standard and dimensions in inches are in *italics*. Technical data valid for copper conductors only.

D6/8.3L spring terminal blocks

Feed-through with 3 connections - 8 mm 0.315 in spacing

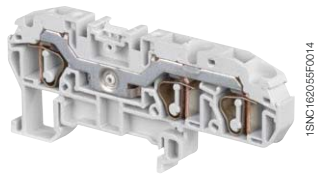

1SNC16205F0014

D6/8.3L

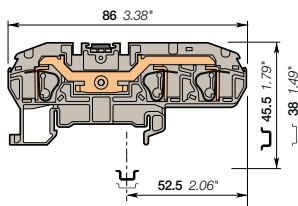

8 mm 0.315 in spacing

Description

- Easy to access thanks to its front wiring entry,
- Clamping contact pressure non dependent on the operator and automatic creeping compensation,
- Numerous built-in functions: double jumper system, clearly visible top marker, test sockets, etc,
- Functional through ergonomic design (alignment).

Ordering details

Description	Color	Type	Order code	Pkg qty	Weight (1 pce) g
Feed-through 3 connections	Grey	D6/8.3L	1SNA290418R0200	30	16.00
	Blue	D6/8.N.3L	1SNA290419R0300	30	16.00
	Orange	D6/8.3L	1SNA290420R0000	30	16.00

Main technical data

Connecting capacity		IEC	UL	CSA	Mounting instructions	
1 conductor per clamp	Rigid - Solid / Stranded	0.5-10 mm ²	20-8 AWG	22-8 AWG	Rail	TH 35-7.5, TH 35-15
	Flexible with non insulated ferrule	0.5-6 mm ²			Wire stripping length	13 mm 0.51 in
	with insulated ferrule				Tool	Flat screwdriver Ø 5.5 mm Ø 0.217 in
	Gauge	A5				
Rated current / Rated cross section		41 A / 6 mm ²	40 A / 8 AWG	40 A / 8 AWG		
Rated short-time withstand current (1s)		720 A				
Rated voltage		800 V	600 V	600 V		
Impulse withstand voltage		8000 V				
Protection		IP20	NEMA 1			

The connecting capacity data for one Rigid - Solid / Stranded - Flexible conductor (when applicable) is a mandatory information required by IEC, UL and CSA standards. All other data are provided as supplementary information only. For more details, please consult our CB, UL or CSA certificates and technical datasheet available on <http://www.abb.com>



Accessories

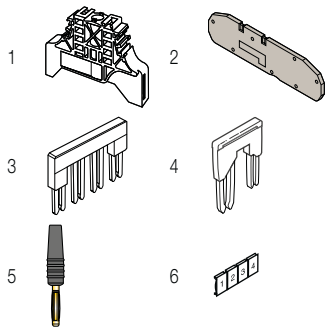

Description	Color	Type	Order code	Pkg qty	Weight (1 pce) g			
1 End stops	Grey	BADL	1SNA399903R0200	50	4.70			
		BAM2	1SNA206351R1600	50	12.00			
2 End sections	Grey	FED8.3L	1SNA291711R2400	20	3.40			
	Orange		1SNA291713R2600	20	3.40			
3 Jumper bars	Orange	2 poles	41 A	BJDL8-2	1SNA291122R1600	50	0.20	
		3 poles		BJDL8-3	1SNA291123R1700	50	0.40	
		4 poles		BJDL8-4	1SNA291144R2400	50	0.50	
		5 poles		BJDL8-5	1SNA291145R2500	20	3.90	
		5 poles		BJDPL8.10-2	1SNA291484R1200	20	1.50	
4 Cross spacing jumpers	Orange	5 mm 0.200 in - 8 mm 0.315 in		BJDPL5.8-2	1SNA291160R0000	20	1.65	
		6 mm 0.236 in - 8 mm 0.315 in		BJDPL6.8-2	1SNA291170R0200	20	0.20	
		8 mm 0.315 in - 10 mm 0.400 in		BJDPL8.10-2	1SNA291484R1200	20	1.50	
5 Test plugs		DIA 2 mm 0.079 in		Black	FC2.MC	1SNA107239R0300	20	1.00
6 Terminal block markers		Blank card		White	RC810	1SNA234000R0200	1	8.20

Complete list of accessories is indicated in the terminal block datasheet. Some accessories such as jumper bars may modify the terminal block's ratings: complete information in the accessories catalogue pages.

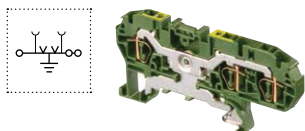

Ground spring terminal blocks

Description	Color	Type	Order code	Pkg qty	Weight (1 pce) g
Ground	Green-yellow	D6/8.P.3L	1SNA290422R2600	30	20.80

All the technical data for UL/CSA standard and dimensions in inches are in *italics*. Technical data valid for copper conductors only.

D10/10.1.2L spring terminal blocks

Feed-through with 2 connections - 10 mm 0.394 in spacing

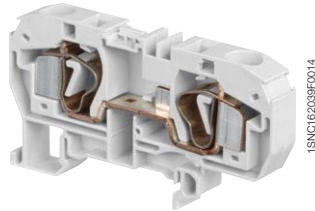

D10/10.1.2L

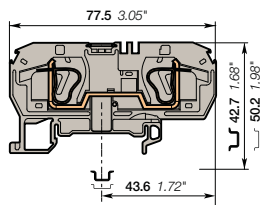

10 mm 0.394 in spacing

Description

- Easy to access thanks to its front wiring entry,
- Clamping contact pressure non dependent on the operator and automatic creeping compensation,
- Numerous built-in functions: double jumper system, clearly visible top marker, test sockets, etc,
- Functional through ergonomic design (alignment).

Ordering details

Description	Color	Type	Order code	Pkg qty	Weight (1 pce) g
Feed-through 2 connections	Grey	D10/10.1.2L	1SNA290301R1500	25	11.00
	Blue	D10/10.1.N.2L	1SNA290303R1700	25	11.00
	Orange	D10/10.1.2L	1SNA290302R1600	25	11.00

Main technical data

Connecting capacity		IEC	UL	CSA	Mounting instructions	
1 conductor per clamp	Rigid - Solid / Stranded	0.5-16 mm ²	20-6 AWG	20-6 AWG	Rail	TH 35-7.5, TH 35-15
	Flexible with non insulated ferrule	0.5-10 mm ²			Wire stripping length	12 mm 0.47 in
	with insulated ferrule				Tool	Flat screwdriver Ø 5.5 mm Ø 0.217 in
	Gauge	B6				
Rated current / Rated cross section		57 A / 10 mm ²	50 A / 6 AWG	50 A / 6 AWG		
Rated short-time withstand current (1s)		1200 A				
Rated voltage		1000 V	600 V	600 V		
Impulse withstand voltage		8000 V				
Protection		IP20	NEMA 1			

The connecting capacity data for one Rigid - Solid / Stranded - Flexible conductor (when applicable) is a mandatory information required by IEC, UL and CSA standards. All other data are provided as supplementary information only. For more details, please consult our CB, UL or CSA certificates and technical datasheet available on <http://www.abb.com>



Accessories

Description	Color	Type	Order code	Pkg qty	Weight (1 pce) g	
1 End stops	Grey	BADL	1SNA399903R0200	50	4.70	
		BAM2	1SNA206351R1600	50	12.00	
2 End sections	Grey	FED10.2L	1SNA291461R2200	20	4.10	
3 Jumper bars	Orange	2 poles	BJDL1.10.2	1SNA291472R2500	50	2.45
		3 poles	BJDL1.10.3	1SNA291474R2700	50	3.65
		4 poles	BJDL1.10.4	1SNA291476R2100	50	4.86
		5 poles	BJDL1.10-5	1SNA291478R0300	50	6.05
		4 Cross spacing jumpers	Orange	BJDPL5.10-2	1SNA291480R2200	20
	Orange	6 mm 0.236 in - 10 mm 0.400 in	BJDPL6.10-2	1SNA291482R1000	20	1.00
		8 mm 0.315 in - 10 mm 0.400 in	BJDPL8.10-2	1SNA291484R1200	20	1.50
		5 Test plugs	Black	FC2.MC	1SNA107239R0300	20
6 Terminal block markers	White	RC1010	1SNA238000R1600	1	1.30	

Complete list of accessories is indicated in the terminal block datasheet. Some accessories such as jumper bars may modify the terminal block's ratings: complete information in the accessories catalogue pages.

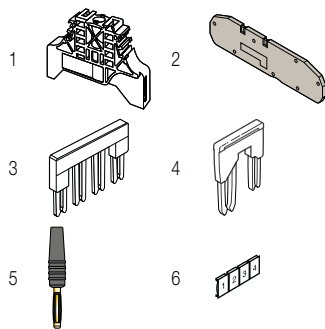

Ground spring terminal blocks

Description	Color	Type	Order code	Pkg qty	Weight (1 pce) g
Ground	Green-yellow	D10/10.1.P.2L	1SNA290309R2500	25	28.00

All the technical data for UL/CSA standard and dimensions in inches are in italic. Technical data valid for copper conductors only.

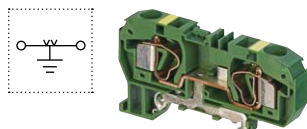

D10/10.3L spring terminal blocks

Feed-through with 3 connections - 10 mm 0.394 in spacing

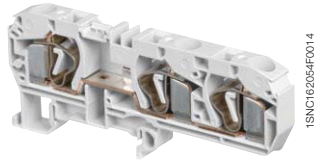

D10/10.3L

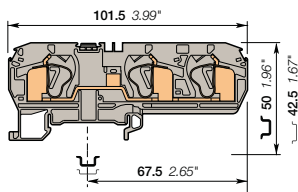

10 mm 0.394 in spacing

Description

- Easy to access thanks to its front wiring entry,
- Clamping contact pressure non dependent on the operator and automatic creeping compensation,
- Numerous built-in functions: double jumper system, clearly visible top marker, test sockets, etc,
- Functional through ergonomic design (alignment).

Ordering details

Description	Color	Type	Order code	Pkg qty	Weight (1 pce) g
Feed-through 3 connections	Grey	D10/10.3L	1SNA290423R2700	25	35.28
	Blue	D10/10.N.3L	1SNA290424R2000	25	35.28
	Orange	D10/10.3L	1SNA290425R2100	25	35.28

Main technical data

Connecting capacity		IEC	UL	CSA
1 conductor per clamp	Rigid - Solid / Stranded	0.5-16 mm ²	20-6 AWG	20-6 AWG
	Flexible with non insulated ferrule	0.5-10 mm ²		
	with insulated ferrule			
	Gauge	B6		
Rated current / Rated cross section		57 A / 10 mm ²	50 A / 6 AWG	50 A / 6 AWG
Rated short-time withstand current (1s)		1200 A		
Rated voltage		1000 V	600 V	600 V
Impulse withstand voltage		8000 V		
Protection		IP20	NEMA 1	

Mounting instructions

Rail		TH 35-7.5, TH 35-15
Wire stripping length		12 mm 0.47 in
Tool		Flat screwdriver Ø 5.5 mm Ø 0.217 in

The connecting capacity data for one Rigid - Solid / Stranded - Flexible conductor (when applicable) is a mandatory information required by IEC, UL and CSA standards. All other data are provided as supplementary information only. For more details, please consult our CB, UL or CSA certificates and technical datasheet available on <http://www.abb.com>



Accessories

Description	Color	Type	Order code	Pkg qty	Weight (1 pce) g	
1 End stops	Grey	BADL	1SNA399903R0200	50	4.70	
		BAM2	1SNA206351R1600	50	12.00	
2 End sections	Grey	FED10.3L	1SNA291731R2000	20	4.00	
3 Jumper bars	Orange	2 poles	BJDL1.10.2	1SNA291472R2500	50	2.45
		3 poles	BJDL1.10.3	1SNA291474R2700	50	3.65
		4 poles	BJDL1.10.4	1SNA291476R2100	50	4.86
		5 poles	BJDL1.10-5	1SNA291478R0300	50	6.05
		4 Cross spacing jumpers	Orange	BJDPL5.10-2	1SNA291480R2200	20
		6 mm 0.236 in - 10 mm 0.400 in	BJDPL6.10-2	1SNA291482R1000	20	1.00
		8 mm 0.315 in - 10 mm 0.400 in	BJDPL8.10-2	1SNA291484R1200	20	1.50
		5 Test plugs	Black	FC2.MC	1SNA107239R0300	20
6 Terminal block markers	White	RC1010	1SNA238000R1600	1	1.30	

Complete list of accessories is indicated in the terminal block datasheet. Some accessories such as jumper bars may modify the terminal block's ratings: complete information in the accessories catalogue pages.

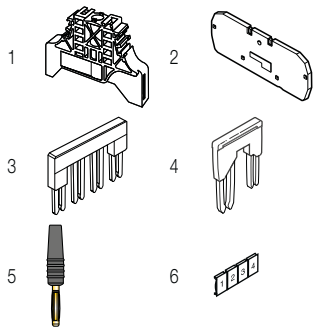

Ground spring terminal blocks

Description	Color	Type	Order code	Pkg qty	Weight (1 pce) g
Ground	Green-yellow	D10/10.P.3L	1SNA290427R2300	25	40.00

All the technical data for UL/CSA standard and dimensions in inches are in italic. Technical data valid for copper conductors only.

D16/12.2L spring terminal blocks

Feed-through with 2 connections - 12 mm 0.472 in spacing

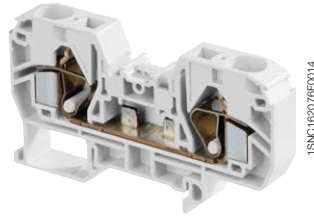

D16/12.2L

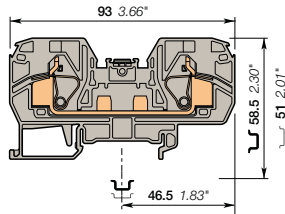

12 mm 0.472 in spacing

Description

- Easy to access thanks to its front wiring entry,
- Clamping contact pressure non dependent on the operator and automatic creeping compensation,
- Numerous built-in functions: double jumper system, clearly visible top marker, test sockets, etc,
- Functional through ergonomic design (alignment).

Ordering details

Description	Color	Type	Order code	Pkg qty	Weight (1 pce) g
Feed-through 2 connections	Grey	D16/12.2L	1SNA399581R2700	25	27.00
	Blue	D16/12.N.2L	1SNA399582R2000	25	27.00
	Yellow	D16/12.2L	1SNA400180R0700	25	27.00
	Red	D16/12.2L	1SNA400179R1100	25	27.00
	Black	D16/12.2L	1SNA400178R1000	25	27.00

Main technical data

Connecting capacity		IEC	UL	CSA	Mounting instructions	
1 conductor per clamp	Rigid - Solid / Stranded	0.5-25 mm ²	20-6 AWG	20-6 AWG	Rail	TH 35-7.5, TH 35-15
	Flexible with non insulated ferrule	0.5-16 mm ²			Wire stripping length	19 mm 0.73 in
	with insulated ferrule				Tool	Flat screwdriver Ø 6.5 mm Ø 0.256 in
Gauge	A7					
Rated current / Rated cross section		76 A / 16 mm ²	54 A / 6 AWG	54 A / 6 AWG		
Rated short-time withstand current (1s)		1920 A				
Rated voltage		1000 V	600 V	600 V		
Impulse withstand voltage		8000 V				
Protection		IP20	NEMA 1			

The connecting capacity data for one Rigid - Solid / Stranded - Flexible conductor (when applicable) is a mandatory information required by IEC, UL and CSA standards. All other data are provided as supplementary information only. For more details, please consult our CB, UL or CSA certificates and technical datasheet available on <http://www.abb.com>



Accessories

Description	Color	Type	Order code	Pkg qty	Weight (1 pce) g
1 End stops	Grey	BADL	1SNA399903R0200	50	4.70
		BAM2	1SNA206351R1600	50	12.00
2 End sections	Grey	FED12.2L	1SNA399571R0400	10	5.00
3 Jumper bars	Orange	BJDL12-2	1SNA399563R0400	25	7.00
4 Cross spacing jumpers	Orange	BJDPL6.12-2	1SNA399613R0600	20	3.10
5 Test plugs	Black	FC2.MC	1SNA107239R0300	20	1.00
6 Terminal block markers	White	RC1010	1SNA238000R1600	1	1.30

Complete list of accessories is indicated in the terminal block datasheet. Some accessories such as jumper bars may modify the terminal block's ratings: complete information in the accessories catalogue pages.

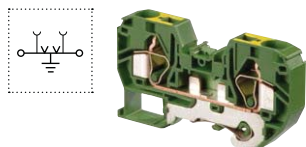
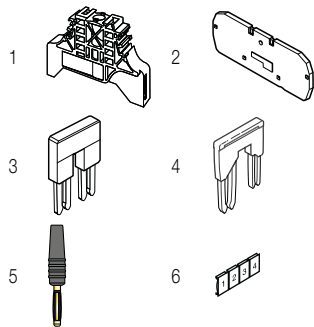

Ground spring terminal blocks

Description	Color	Type	Order code	Pkg qty	Weight (1 pce) g
Ground	Green-yellow	D16/12.P.2L	1SNA399584R2200	25	56.00

All the technical data for UL/CSA standard and dimensions in inches are in *italics*. Technical data valid for copper conductors only.

D16/12.3L spring terminal blocks

Feed-through with 3 connections - 12 mm 0.472 in spacing



16 mm²
4 AWG

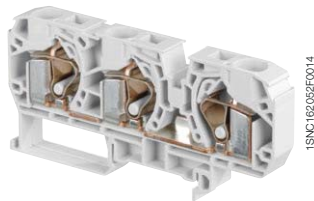

1SNC162025E0014

D16/12.3L

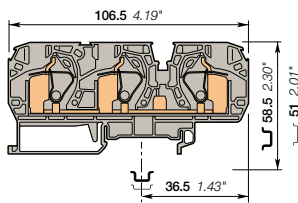

12 mm 0.472 in spacing

Description

- Easy to access thanks to its front wiring entry,
- Clamping contact pressure non dependent on the operator and automatic creeping compensation,
- Numerous built-in functions: double jumper system, clearly visible top marker, test sockets, etc,
- Functional through ergonomic design (alignment).

Ordering details

Description	Color	Type	Order code	Pkg qty	Weight (1 pce) g
Feed-through 3 connections	Grey	D16/12.3L	1SNA290428R0400	10	55.00
	Blue	D16/12.N.3L	1SNA290429R0500	10	55.00
	Orange	D16/12.3L	1SNA290430R0200	10	55.00

Main technical data

Connecting capacity		IEC	UL	CSA	Mounting instructions	
1 conductor per clamp	Rigid - Solid / Stranded	0.5-25 mm ²	20-4 AWG	20-4 AWG	Rail	TH 35-7.5, TH 35-15
	Flexible with non insulated ferrule	0.5-16 mm ²			Wire stripping length	19 mm 0.73 in
	with insulated ferrule				Tool	Flat screwdriver Ø 6.5 mm Ø 0.256 in
	Gauge	A7				
Rated current / Rated cross section		76 A / 16 mm ²	54 A / 4 AWG	54 A / 4 AWG		
Rated short-time withstand current (1s)		1920 A				
Rated voltage		1000 V	600 V	600 V		
Impulse withstand voltage		8000 V				
Protection		IP20	NEMA 1			

The connecting capacity data for one Rigid - Solid / Stranded - Flexible conductor (when applicable) is a mandatory information required by IEC, UL and CSA standards. All other data are provided as supplementary information only. For more details, please consult our CB, UL or CSA certificates and technical datasheet available on <http://www.abb.com>



Accessories

Description	Color	Type	Order code	Pkg qty	Weight (1 pce) g
1 End stops	Grey	BADL	1SNA399903R0200	50	4.70
		BAM2	1SNA206351R1600	50	12.00
2 End sections	Grey	FED12.3L	1SNA291721R2600	20	5.50
3 Jumper bars	Orange	BJDL12-2	1SNA399563R0400	25	7.00
4 Cross spacing jumpers	Orange	BJDPL6.12-2	1SNA399613R0600	20	3.10
5 Test plugs	Black	FC2.MC	1SNA107239R0300	20	1.00
6 Terminal block markers	White	RC1010	1SNA238000R1600	1	1.30

Complete list of accessories is indicated in the terminal block datasheet. Some accessories such as jumper bars may modify the terminal block's ratings: complete information in the accessories catalogue pages.

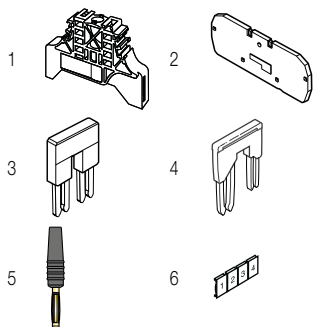

Ground spring terminal blocks

Description	Color	Type	Order code	Pkg qty	Weight (1 pce) g
Ground	Green-yellow	D16/12.P.3L	1SNA290432R2000	10	72.00

All the technical data for UL/CSA standard and dimensions in inches are in italic. Technical data valid for copper conductors only.

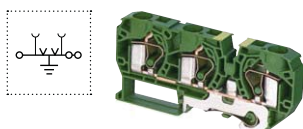

D35/16.2L spring terminal blocks

Feed-through with 2 connections - 16 mm 0.630 in spacing



35 mm²
2 AWG

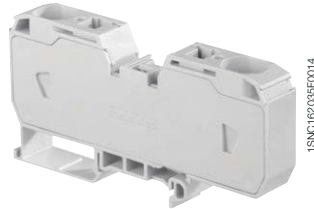

D35/16.2L

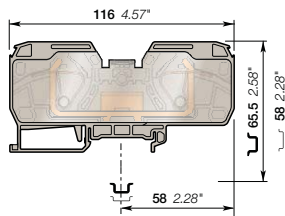

16 mm 0.630 in spacing

Description

- Easy to access thanks to its front wiring entry,
- Clamping contact pressure non dependent on the operator and automatic creeping compensation,
- Numerous built-in functions: double jumper system, clearly visible top marker, test sockets, etc,
- Functional through ergonomic design (alignment).

Ordering details

Description	Color	Type	Order code	Pkg qty	Weight (1 pce) g
Feed-through 2 connections	Grey	D35/16.2L	1SNA399617R0200	10	95.00
	Blue	D35/16.N.2L	1SNA399618R1300	10	95.00
	Yellow	D35/16.2L	1SNA400183R2600	10	95.00
	Red	D35/16.2L	1SNA400182R2200	10	95.00
	Black	D35/16.2L	1SNA400181R2400	10	95.00

Main technical data

Connecting capacity		IEC	UL	CSA	Mounting instructions	
1 conductor per clamp	Rigid - Solid / Stranded	2.5-50 mm ²	14-2 AWG		Rail	TH 35-7.5, TH 35-15
	Flexible with non insulated ferrule	2.5-35 mm ²			Wire stripping length	26 mm 1.02 in
	with insulated ferrule				Tool	Flat screwdriver Ø 6.5 mm Ø 0.256 in
	Gauge	A9				
Rated current / Rated cross section		125 A / 35 mm ²	93 A / 2 AWG			
Rated short-time withstand current (1s)		4200 A				
Rated voltage		1000 V	600 V			
Impulse withstand voltage		8000 V				
Protection		IP20	NEMA 1			

The connecting capacity data for one Rigid - Solid / Stranded - Flexible conductor (when applicable) is a mandatory information required by IEC, UL and CSA standards. All other data are provided as supplementary information only. For more details, please consult our CB, UL or CSA certificates and technical datasheet available on <http://www.abb.com>

RoHS	UL 94V-0	PCB	Gost R
------	----------	-----	--------

Accessories

Description	Color	Type	Order code	Pkg qty	Weight (1 pce) g
1 End stops	Grey	BADH	1SNA116900R2700	50	24.00
2 Jumper bars	Orange	BJDL16-2	1SNA399621R0600	25	10.00
3 Test plugs	Black	FC2.MC	1SNA107239R0300	20	1.00
4 Terminal block markers	White	RC1010	1SNA238000R1600	1	1.30

Complete list of accessories is indicated in the terminal block datasheet. Some accessories such as jumper bars may modify the terminal block's ratings: complete information in the accessories catalogue pages.

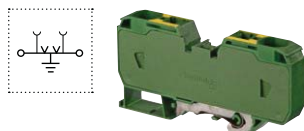
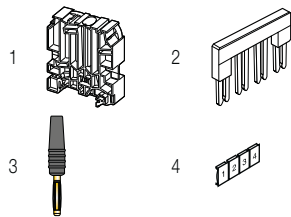

Ground spring terminal blocks

Description	Color	Type	Order code	Pkg qty	Weight (1 pce) g
Ground	Green-yellow	D35/16.P.2L	1SNA399620R1100	10	120.00

All the technical data for UL/CSA standard and dimensions in inches are in *italics*. Technical data valid for copper conductors only.

D2.5/5.P.2L spring terminal blocks

Ground with 2 connections - 5 mm 0.197 in spacing

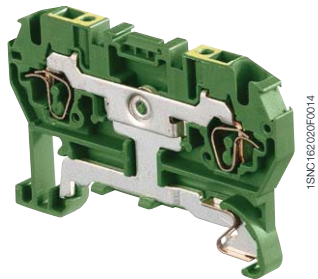

D2.5/5.P.2L

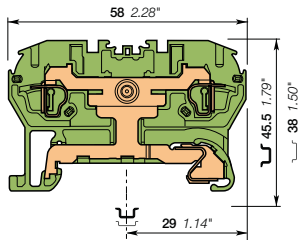

5 mm 0.197 in spacing

Description

- Improve the safety of your installation in the event of a short-circuit thanks to our screwless rail contact,
- Rail contact non operator dependent,
- Performances above the requirements of IEC 60947-7-2 terminal block standard,
- Secure snap on or remove from the rail.

Ordering details

Description	Color	Type	Order code	Pkg qty	Weight (1 pce)
Ground Screwless rail connection	Green-yellow	D2.5/5.P.2L	1SNA290029R0700	50	9.00

Main technical data

Connecting capacity		IEC	UL	CSA	Mounting instructions	
1 conductor per clamp	Rigid - Solid / Stranded	0.12-4 mm ²	26-12 AWG	26-12 AWG	Rail	TH 35-7.5, TH 35-15
	Flexible with non insulated ferrule	0.12-2.5 mm ²			Wire stripping length	9.5 mm 0.37 in
	with insulated ferrule				Tool	Flat screwdriver Ø 3.5 mm Ø 0.138 in
	Gauge	A2				
Rated cross section		2.5 mm ²	12 AWG	12 AWG		
Rated short-time withstand current (1s)		300 A				
Protection		IP20	NEMA 1			

The connecting capacity data for one Rigid - Solid / Stranded - Flexible conductor (when applicable) is a mandatory information required by IEC, UL and CSA standards. All other data are provided as supplementary information only. For more details, please consult our CB, UL or CSA certificates and technical datasheet available on <http://www.abb.com>

RoHS	UL	CSA	Gost R
ReHS	USR CNR		

Accessories

Description	Color	Type	Order code	Pkg qty	Weight (1 pce)
1 End stops	Grey	BADL	1SNA399903R0200	50	4.70
		BAM2	1SNA206351R1600	50	12.00
2 End sections	Grey	FED5.2L	1SNA291061R2400	20	2.00
3 Circuit separators	Orange	SCD5.2L	1SNA291352R0400	20	2.20
4 Terminal block markers	White	RC510	1SNA231000R0700	1	5.20

Complete list of accessories is indicated in the terminal block datasheet. Some accessories such as jumper bars may modify the terminal block's ratings: complete information in the accessories catalogue pages.

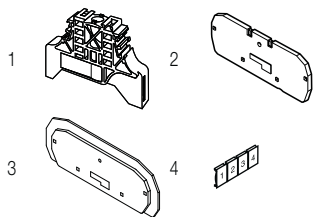

All the technical data for UL/CSA standard and dimensions in inches are in italic. Technical data valid for copper conductors only.

D2.5/5.P.3L spring terminal blocks

Ground with 3 connections - 5 mm 0.197 in spacing



2.5 mm²

12 AWG



1SNC162103F0014

D2.5/5.P.3L

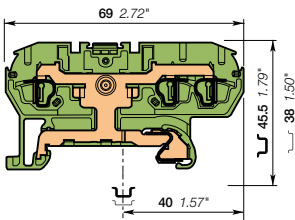

5 mm 0.197 in spacing

Description

- Improve the safety of your installation in the event of a short-circuit thanks to our screwless rail contact,
- Rail contact non operator dependent,
- Performances above the requirements of IEC 60947-7-2 terminal block standard,
- Secure snap on or remove from the rail.

Ordering details

Description	Color	Type	Order code	Pkg qty	Weight (1 pce) g
Ground Screwless rail connection	Green-yellow	D2.5/5.P.3L	1SNA290039R0100	50	11.00

Main technical data

Connecting capacity		IEC	UL	CSA	Mounting instructions	
1 conductor per clamp	Rigid - Solid / Stranded	0.12-4 mm ²	26-12 AWG	26-12 AWG	Rail	TH 35-7.5, TH 35-15
	Flexible with non insulated ferrule	0.12-2.5 mm ²			Wire stripping length	9.5 mm 0.37 in
	with insulated ferrule				Tool	Flat screwdriver Ø 3.5 mm Ø 0.138 in
	Gauge	A2				
Rated cross section		2.5 mm ²	12 AWG	12 AWG		
Rated short-time withstand current (1s)		300 A				
Protection		IP20	NEMA 1			

The connecting capacity data for one Rigid - Solid / Stranded - Flexible conductor (when applicable) is a mandatory information required by IEC, UL and CSA standards. All other data are provided as supplementary information only. For more details, please consult our CB, UL or CSA certificates and technical datasheet available on <http://www.abb.com>



Accessories

Description	Color	Type	Order code	Pkg qty	Weight (1 pce) g
1 End stops	Grey	BADL	1SNA399903R0200	50	4.70
		BAM2	1SNA206351R1600	50	12.00
2 End sections	Grey	FED5.3L	1SNA291051R2200	20	1.90
3 Circuit separators	Orange	SCD5.3L	1SNA291362R0600	20	2.60
4 Terminal block markers	White	RC510	1SNA231000R0700	1	5.20

Complete list of accessories is indicated in the terminal block datasheet. Some accessories such as jumper bars may modify the terminal block's ratings: complete information in the accessories catalogue pages.

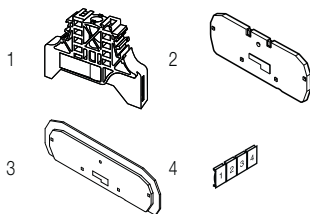

All the technical data for UL/CSA standard and dimensions in inches are in italic. Technical data valid for copper conductors only.

D2.5/5.P.4L spring terminal blocks

Ground with 4 connections - 5 mm 0.197 in spacing



2.5 mm²
12 AWG

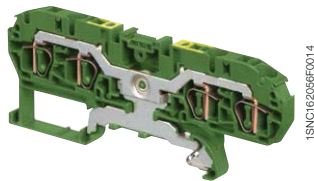

1SNC162059502014

3

D2.5/5.P.4L

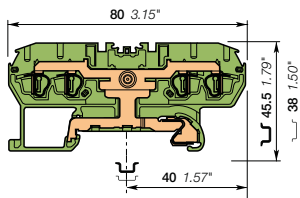

5 mm 0.197 in spacing

Description

- Improve the safety of your installation in the event of a short-circuit thanks to our screwless rail contact,
- Rail contact non operator dependent,
- Performances above the requirements of IEC 60947-7-2 terminal block standard,
- Secure snap on or remove from the rail.

Ordering details

Description	Color	Type	Order code	Pkg qty	Weight (1 pce)
Ground Screwless rail connection	Green-yellow	D2.5/5.P.4L	1SNA290019R0500	50	12.00

Main technical data

Connecting capacity	IEC	UL	CSA	Mounting instructions	
1 conductor per clamp	Rigid - Solid / Stranded Flexible with non insulated ferrule with insulated ferrule Gauge	0.12-4 mm ² 0.12-2.5 mm ² A2	26-12 AWG	26-12 AWG	Rail TH 35-7.5, TH 35-15
					Wire stripping length 9.5 mm 0.37 in
					Tool Flat screwdriver Ø 3.5 mm Ø 0.138 in
Rated cross section	2.5 mm ²	12 AWG	12 AWG		
Rated short-time withstand current (1s)	300 A				
Protection	IP20	NEMA 1			

The connecting capacity data for one Rigid - Solid / Stranded - Flexible conductor (when applicable) is a mandatory information required by IEC, UL and CSA standards. All other data are provided as supplementary information only. For more details, please consult our CB, UL or CSA certificates and technical datasheet available on <http://www.abb.com>



Accessories

Description	Color	Type	Order code	Pkg qty	Weight (1 pce)
1 End stops	Grey	BADL	1SNA399903R0200	50	4.70
		BAM2	1SNA206351R1600	50	12.00
2 End sections	Grey	FED5.4L	1SNA291041R2000	20	2.20
3 Circuit separators	Orange	SCD5.4L	1SNA291372R0000	20	2.90
4 Terminal block markers	White	RC510	1SNA231000R0700	1	5.20

Complete list of accessories is indicated in the terminal block datasheet. Some accessories such as jumper bars may modify the terminal block's ratings: complete information in the accessories catalogue pages.

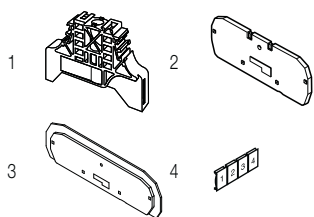

All the technical data for UL/CSA standard and dimensions in inches are in italic. Technical data valid for copper conductors only.

D2.5/5.I.P.3L spring terminal blocks

Ground with 3 connections - 5 mm 0.197 in spacing



D2.5/5.I.P.3L

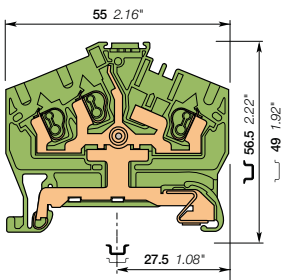

5 mm 0.197 in spacing

Description

- Improve the safety of your installation in the event of a short-circuit thanks to our screwless rail contact,
- Rail contact non operator dependent,
- Performances above the requirements of IEC 60947-7-2 terminal block standard,
- Secure snap on or remove from the rail.

Ordering details

Description	Color	Type	Order code	Pkg qty	Weight (1 pce) g
Ground Screwless rail connection	Green-yellow	D2.5/5.I.P.3L	1SNA399072R0300	50	11.00

Main technical data

Connecting capacity		IEC	UL	CSA	Mounting instructions	
1 conductor per clamp	Rigid - Solid / Stranded	0.12-4 mm ²	26-12 AWG	26-14 AWG	Rail	TH 35-7.5, TH 35-15
	Flexible with non insulated ferrule	0.12-2.5 mm ²			Wire stripping length	9.5 mm 0.37 in
	with insulated ferrule				Tool	Flat screwdriver Ø 3.5 mm Ø 0.138 in
Gauge		A2				
Rated cross section		2.5 mm ²	12 AWG	14 AWG		
Rated short-time withstand current (1s)		300 A				
Protection		IP20	NEMA 1			

The connecting capacity data for one Rigid - Solid / Stranded - Flexible conductor (when applicable) is a mandatory information required by IEC, UL and CSA standards. All other data are provided as supplementary information only. For more details, please consult our CB, UL or CSA certificates and technical datasheet available on <http://www.abb.com>



Accessories

Description	Color	Type	Order code	Pkg qty	Weight (1 pce) g
1 End stops	Grey	BADL	1SNA399903R0200	50	4.70
		BAM2	1SNA206351R1600	50	12.00
2 End sections	Grey	FED5.I.3L	1SNA290311R0600	20	2.10
3 Terminal block markers	White	RC510	1SNA231000R0700	1	5.20

Complete list of accessories is indicated in the terminal block datasheet. Some accessories such as jumper bars may modify the terminal block's ratings: complete information in the accessories catalogue pages.

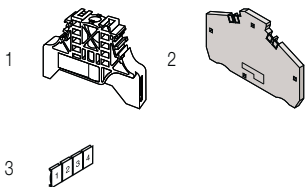

All the technical data for UL/CSA standard and dimensions in inches are in italic. Technical data valid for copper conductors only.

D2.5/5.I.P.4L spring terminal blocks

Ground with 4 connections - 5 mm 0.197 in spacing

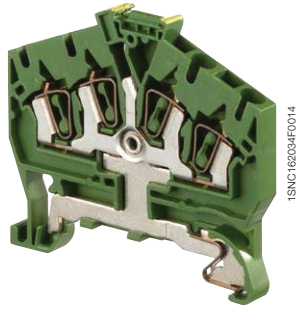

D2.5/5.I.P.4L

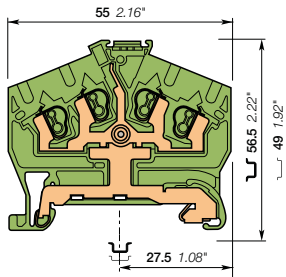

5 mm 0.197 in spacing

Description

- Improve the safety of your installation in the event of a short-circuit thanks to our screwless rail contact,
- Rail contact non operator dependent,
- Performances above the requirements of IEC 60947-7-2 terminal block standard,
- Secure snap on or remove from the rail.

Ordering details

Description	Color	Type	Order code	Pkg qty	Weight (1 pce)
Ground Screwless rail connection:	Green-yellow	D2.5/5.I.P.4L	1SNA399073R0400	50	12.00

Main technical data

Connecting capacity	IEC	UL	CSA	Mounting instructions
1 conductor per clamp	Rigid - Solid / Stranded Flexible with non insulated ferrule with insulated ferrule Gauge	0.12-4 mm ² 0.12-2.5 mm ² A2	26-12 AWG A2	26-14 AWG A2
Rated cross section	2.5 mm ²	12 AWG	14 AWG	
Rated short-time withstand current (1s)	300 A			
Protection	IP20	NEMA 1		
Mounting instructions Rail: TH 35-7.5, TH 35-15 Wire stripping length: 9.5 mm 0.37 in Tool: Flat screwdriver Ø 3.5 mm Ø 0.138 in				

The connecting capacity data for one Rigid - Solid / Stranded - Flexible conductor (when applicable) is a mandatory information required by IEC, UL and CSA standards. All other data are provided as supplementary information only. For more details, please consult our CB, UL or CSA certificates and technical datasheet available on <http://www.abb.com>

RoHS	UL	CSA	Gost R
RoHS	USR CNR	CSA	Gost R

Accessories

Description	Color	Type	Order code	Pkg qty	Weight (1 pce)
1 End stops	Grey	BADL	1SNA399903R0200	50	4.70
		BAM2	1SNA206351R1600	50	12.00
2 End sections	Grey	FED5.I.3L	1SNA290311R0600	20	2.10
3 Terminal block markers	White	RC510	1SNA231000R0700	1	5.20

Complete list of accessories is indicated in the terminal block datasheet.

Some accessories such as jumper bars may modify the terminal block's ratings: complete information in the accessories catalogue pages.

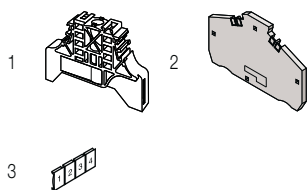

All the technical data for UL/CSA standard and dimensions in inches are in italic. Technical data valid for copper conductors only.

D4/6.P.2L spring terminal blocks

Ground with 2 connections - 6 mm 0.236 in spacing

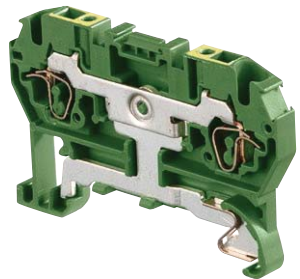

D4/6.P.2L

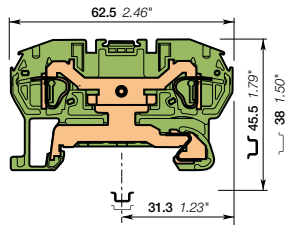

6 mm 0.236 in spacing

Description

- Improve the safety of your installation in the event of a short-circuit thanks to our screwless rail contact,
- Rail contact non operator dependent,
- Performances above the requirements of IEC 60947-7-2 terminal block standard,
- Secure snap on or remove from the rail.

Ordering details

Description	Color	Type	Order code	Pkg qty	Weight (1 pce) g
Ground Screwless rail connection	Green-yellow	D4/6.P.2L	1SNA290069R1700	50	12.00

Main technical data

Connecting capacity		IEC	UL	CSA	Mounting instructions	
1 conductor per clamp	Rigid - Solid / Stranded	0.2-6 mm ²	24-10 AWG	24-10 AWG	Rail	TH 35-7.5, TH 35-15
	Flexible with non insulated ferrule	0.2-4 mm ²			Wire stripping length	11 mm 0.43 in
	with insulated ferrule				Tool	Flat screwdriver Ø 4 mm Ø 0.157 in
	Gauge	A4				
Rated cross section		4.0 mm ²	10 AWG	10 AWG		
Rated short-time withstand current (1s)		480 A				
Protection		IP20	NEMA 1			

The connecting capacity data for one Rigid - Solid / Stranded - Flexible conductor (when applicable) is a mandatory information required by IEC, UL and CSA standards. All other data are provided as supplementary information only. For more details, please consult our CB, UL or CSA certificates and technical datasheet available on <http://www.abb.com>



Accessories

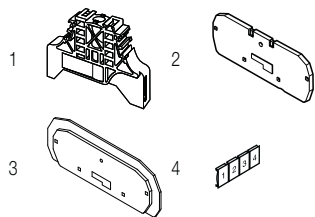

Description	Color	Type	Order code	Pkg qty	Weight (1 pce) g
1 End stops	Grey	BADL	1SNA399903R0200	50	4.70
		BAM2	1SNA206351R1600	50	12.00
2 End sections	Grey	FED5.2L	1SNA291061R2400	20	2.00
3 Circuit separators	Orange	SCD5.2L	1SNA291352R0400	20	2.20
4 Terminal block markers	White	RC610	1SNA233000R0100	1	7.50

Complete list of accessories is indicated in the terminal block datasheet. Some accessories such as jumper bars may modify the terminal block's ratings: complete information in the accessories catalogue pages.

All the technical data for UL/CSA standard and dimensions in inches are in italic. Technical data valid for copper conductors only.

D4/6.P.3L spring terminal blocks

Ground with 3 connections - 6 mm 0.236 in spacing

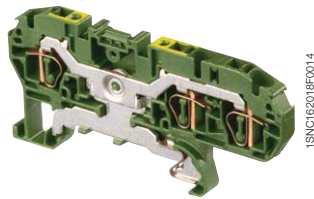

D4/6.P.3L

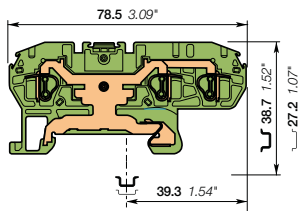

6 mm 0.236 in spacing

Description

- Improve the safety of your installation in the event of a short-circuit thanks to our screwless rail contact,
- Rail contact non operator dependent,
- Performances above the requirements of IEC 60947-7-2 terminal block standard,
- Secure snap on or remove from the rail.

Ordering details

Description	Color	Type	Order code	Pkg qty	Weight (1 pce)
Ground	Screwless rail connection: Green-yellow	D4/6.P.3L	1SNA290409R1200	50	11.00

Main technical data

Connecting capacity		IEC	UL	CSA	Mounting instructions	
1 conductor per clamp	Rigid - Solid / Stranded	0.2-6 mm ²	24-10 AWG	24-10 AWG	Rail	TH 35-7.5, TH 35-15
	Flexible with non insulated ferrule	0.2-4 mm ²			Wire stripping length	11 mm 0.43 in
	with insulated ferrule				Tool	Flat screwdriver Ø 4 mm Ø 0.157 in
	Gauge	A4				
Rated cross section		4.0 mm ²	10 AWG	10 AWG		
Rated short-time withstand current (1s)		480 A				
Protection		IP20	NEMA 1			

The connecting capacity data for one Rigid - Solid / Stranded - Flexible conductor (when applicable) is a mandatory information required by IEC, UL and CSA standards. All other data are provided as supplementary information only. For more details, please consult our CB, UL or CSA certificates and technical datasheet available on <http://www.abb.com>



Accessories

Description	Color	Type	Order code	Pkg qty	Weight (1 pce)
1 End stops	Grey	BADL	1SNA399903R0200	50	4.70
		BAM2	1SNA206351R1600	50	12.00
2 End sections	Grey	FED6.3L	1SNA291694R2400	20	2.50
3 Terminal block markers	White	RC610	1SNA233000R0100	1	7.50

Complete list of accessories is indicated in the terminal block datasheet.

Some accessories such as jumper bars may modify the terminal block's ratings: complete information in the accessories catalogue pages.

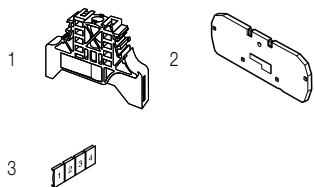

All the technical data for UL/CSA standard and dimensions in inches are in italic. Technical data valid for copper conductors only.

D4/6.P.4L spring terminal blocks

Ground with 4 connections - 6 mm 0.236 in spacing

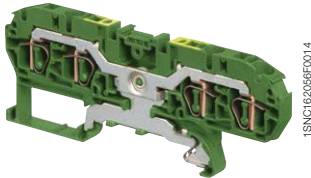

D4/6.P.4L

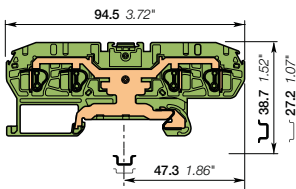

6 mm 0.236 in spacing

Description

- Improve the safety of your installation in the event of a short-circuit thanks to our screwless rail contact,
- Rail contact non operator dependent,
- Performances above the requirements of IEC 60947-7-2 terminal block standard,
- Secure snap on or remove from the rail.

Ordering details

Description	Color	Type	Order code	Pkg qty	Weight (1 pce) g
Ground Screwless rail connection	Green-yellow	D4/6.P.4L	1SNA290414R2600	50	14.00

Main technical data

Connecting capacity		IEC	UL	CSA	Mounting instructions	
1 conductor per clamp	Rigid - Solid / Stranded	0.2-6 mm ²	24-10 AWG	24-10 AWG	Rail	TH 35-7.5, TH 35-15
	Flexible with non insulated ferrule	0.2-4 mm ²			Wire stripping length	11 mm 0.43 in
	with insulated ferrule				Tool	Flat screwdriver Ø 4 mm 0.157 in
	Gauge	A4				
Rated cross section		4.0 mm ²	10 AWG	10 AWG		
Rated short-time withstand current (1s)		480 A				
Protection		IP20	NEMA 1			

The connecting capacity data for one Rigid - Solid / Stranded - Flexible conductor (when applicable) is a mandatory information required by IEC, UL and CSA standards. All other data are provided as supplementary information only. For more details, please consult our CB, UL or CSA certificates and technical datasheet available on <http://www.abb.com>



Accessories

Description	Color	Type	Order code	Pkg qty	Weight (1 pce) g
1 End stops	Grey	BADL	1SNA399903R0200	50	4.70
		BAM2	1SNA206351R1600	50	12.00
2 End sections	Grey	FED6.4L	1SNA291696R2600	20	2.85
3 Terminal block markers	White	RC610	1SNA233000R0100	1	7.50

Complete list of accessories is indicated in the terminal block datasheet.

Some accessories such as jumper bars may modify the terminal block's ratings: complete information in the accessories catalogue pages.

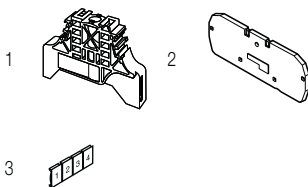

All the technical data for UL/CSA standard and dimensions in inches are in italic. Technical data valid for copper conductors only.

D6/8.P.2L spring terminal blocks

Ground with 2 connections - 8 mm 0.315 in spacing

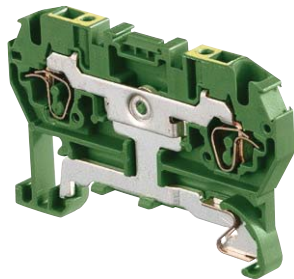

D6/8.P.2L

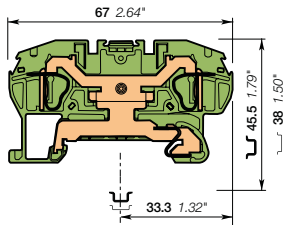

8 mm 0.315 in spacing

Description

- Improve the safety of your installation in the event of a short-circuit thanks to our screwless rail contact,
- Rail contact non operator dependent,
- Performances above the requirements of IEC 60947-7-2 terminal block standard,
- Secure snap on or remove from the rail.

Ordering details

Description	Color	Type	Order code	Pkg qty	Weight (1 pce)
Ground Screwless rail connection	Green-yellow	D6/8.P.2L	1SNA290089R0400	50	16.00

Main technical data

Connecting capacity		IEC	UL	CSA	Mounting instructions	
1 conductor per clamp	Rigid - Solid / Stranded	0.5-10 mm ²	22-8 AWG	22-8 AWG	Rail	TH 35-7.5, TH 35-15
	Flexible with non insulated ferrule	0.5-6 mm ²			Wire stripping length	12.5 mm 0.49 in
	with insulated ferrule				Tool	Flat screwdriver Ø 5.5 mm Ø 0.217 in
Gauge	A5					
Rated cross section		6.0 mm ²	8 AWG	8 AWG		
Rated short-time withstand current (1s)		720 A				
Protection		IP20	NEMA 1			

The connecting capacity data for one Rigid - Solid / Stranded - Flexible conductor (when applicable) is a mandatory information required by IEC, UL and CSA standards. All other data are provided as supplementary information only. For more details, please consult our CB, UL or CSA certificates and technical datasheet available on <http://www.abb.com>



Accessories

Description	Color	Type	Order code	Pkg qty	Weight (1 pce)
1 End stops	Grey	BADL	1SNA399903R0200	50	4.70
		BAM2	1SNA206351R1600	50	12.00
2 End sections	Grey	FED8.2L	1SNA291161R2500	20	2.00
3 Terminal block markers	White	RC810	1SNA234000R0200	1	8.20

Complete list of accessories is indicated in the terminal block datasheet.

Some accessories such as jumper bars may modify the terminal block's ratings: complete information in the accessories catalogue pages.

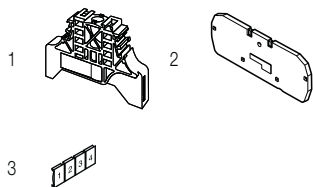

All the technical data for UL/CSA standard and dimensions in inches are in italic. Technical data valid for copper conductors only.

D6/8.P.3L spring terminal blocks

Ground with 3 connections - 8 mm 0.315 in spacing

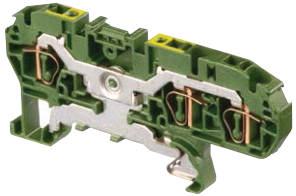

1SNC162018F0014

D6/8.P.3L

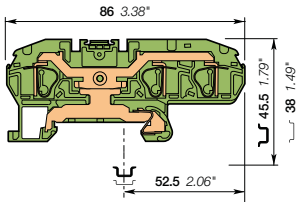

8 mm 0.315 in spacing

Description

- Improve the safety of your installation in the event of a short-circuit thanks to our screwless rail contact,
- Rail contact non operator dependent,
- Performances above the requirements of IEC 60947-7-2 terminal block standard,
- Secure snap on or remove from the rail.

Ordering details

Description	Color	Type	Order code	Pkg qty	Weight (1 pce)
Ground	Screwless rail connection: Green-yellow	D6/8.P.3L	1SNA290422R2600	30	20.80 g

Main technical data

Connecting capacity		IEC	UL	CSA	Mounting instructions	
1 conductor per clamp	Rigid - Solid / Stranded	0.5-10 mm ²	20-8 AWG	22-8 AWG	Rail	TH 35-7.5, TH 35-15
	Flexible with non insulated ferrule	0.5-6 mm ²			Wire stripping length	11 mm 0.42 in
	with insulated ferrule				Tool	Flat screwdriver Ø 5.5 mm Ø 0.217 in
	Gauge	A5				
Rated cross section		6.0 mm ²	8 AWG	8 AWG		
Rated short-time withstand current (1s)		720 A				
Protection		IP20	NEMA 1			

The connecting capacity data for one Rigid - Solid / Stranded - Flexible conductor (when applicable) is a mandatory information required by IEC, UL and CSA standards. All other data are provided as supplementary information only. For more details, please consult our CB, UL or CSA certificates and technical datasheet available on <http://www.abb.com>



Accessories

Description	Color	Type	Order code	Pkg qty	Weight (1 pce)
1 End stops	Grey	BADL	1SNA399903R0200	50	4.70 g
		BAM2	1SNA206351R1600	50	12.00 g
2 End sections	Grey	FED8.3L	1SNA291711R2400	20	3.40 g
3 Terminal block markers	White	RC810	1SNA234000R0200	1	8.20 g

Complete list of accessories is indicated in the terminal block datasheet. Some accessories such as jumper bars may modify the terminal block's ratings: complete information in the accessories catalogue pages.

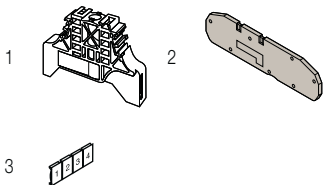

All the technical data for UL/CSA standard and dimensions in inches are in italic. Technical data valid for copper conductors only.

D10/10.1.P.2L spring terminal blocks

Ground with 2 connections - 10 mm 0.394 in spacing

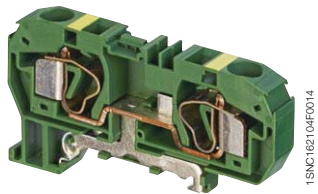

D10/10.1.P.2L

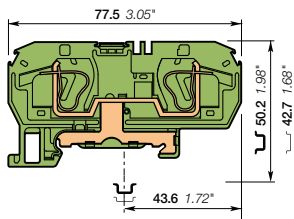

10 mm 0.394 in spacing

Description

- Improve the safety of your installation in the event of a short-circuit thanks to our screwless rail contact,
- Rail contact non operator dependent,
- Performances above the requirements of IEC 60947-7-2 terminal block standard,
- Secure snap on or remove from the rail.

Ordering details

Description	Color	Type	Order code	Pkg qty	Weight (1 pce)
Ground Screwless rail connection	Green-yellow	D10/10.1.P.2L	1SNA290309R2500	25	28.00

Main technical data

Connecting capacity		IEC	UL	CSA	Mounting instructions	
1 conductor per clamp	Rigid - Solid / Stranded	0.5-16 mm ²	20-6 AWG	20-6 AWG	Rail	TH 35-7.5, TH 35-15
	Flexible with non insulated ferrule	0.5-10 mm ²			Wire stripping length	12 mm 0.47 in
	with insulated ferrule				Tool	Flat screwdriver Ø 5.5 mm Ø 0.217 in
	Gauge	B6				
Rated cross section		10.0 mm ²	6 AWG	6 AWG		
Rated short-time withstand current (1s)		1200 A				
Protection		IP20	NEMA 1			

The connecting capacity data for one Rigid - Solid / Stranded - Flexible conductor (when applicable) is a mandatory information required by IEC, UL and CSA standards. All other data are provided as supplementary information only. For more details, please consult our CB, UL or CSA certificates and technical datasheet available on <http://www.abb.com>



Accessories

Description	Color	Type	Order code	Pkg qty	Weight (1 pce)
1 End stops	Grey	BADL	1SNA399903R0200	50	4.70
		BAM2	1SNA206351R1600	50	12.00
2 End sections	Grey	FED10.2L	1SNA291461R2200	20	4.10
3 Jumper bars	Orange	BJDL1.10.2	1SNA291472R2500	50	2.45
4 Terminal block markers	White	RC1010	1SNA238000R1600	1	1.30

Complete list of accessories is indicated in the terminal block datasheet. Some accessories such as jumper bars may modify the terminal block's ratings: complete information in the accessories catalogue pages.

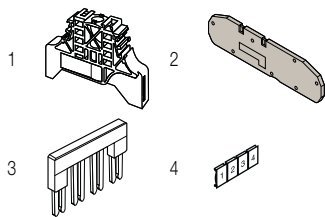

All the technical data for UL/CSA standard and dimensions in inches are in italic. Technical data valid for copper conductors only.

D10/10.P.3L spring terminal blocks

Ground with 3 connections - 10 mm 0.394 in spacing



10 mm²
6 AWG

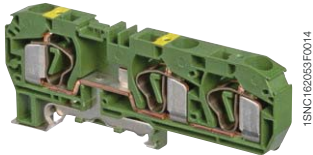

1SNC162067S0201

D10/10.P.3L

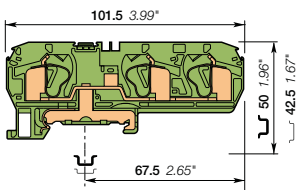

10 mm 0.394 in spacing

Description

- Improve the safety of your installation in the event of a short-circuit thanks to our screwless rail contact,
- Rail contact non operator dependent,
- Performances above the requirements of IEC 60947-7-2 terminal block standard,
- Secure snap on or remove from the rail.

Ordering details

Description	Color	Type	Order code	Pkg qty	Weight (1 pce) g
Ground Screwless rail connection	Green-yellow	D10/10.P.3L	1SNA290427R2300	25	40.00

Main technical data

Connecting capacity		IEC	UL	CSA	Mounting instructions	
1 conductor per clamp	Rigid - Solid / Stranded	0.5-16 mm ²	20-6 AWG	22-8 AWG	Rail	TH 35-7.5, TH 35-15
	Flexible with non insulated ferrule	0.5-10 mm ²			Wire stripping length	12 mm 0.47 in
	with insulated ferrule				Tool	Flat screwdriver Ø 5.5 mm Ø 0.217 in
Gauge	B6					
Rated cross section		10.0 mm ²	6 AWG	8 AWG		
Rated short-time withstand current (1s)		1200 A				
Protection		IP20	NEMA 1			

The connecting capacity data for one Rigid - Solid - Flexible conductor (when applicable) is a mandatory information required by IEC, UL and CSA standards. All other data are provided as supplementary information only. For more details, please consult our CB, UL or CSA certificates and technical datasheet available on <http://www.abb.com>



Accessories

Description	Color	Type	Order code	Pkg qty	Weight (1 pce) g
1 End stops	Grey	BADL	1SNA399903R0200	50	4.70
		BAM2	1SNA206351R1600	50	12.00
2 End sections	Grey	FED10.3L	1SNA291731R2000	20	4.00
3 Jumper bars	Orange	BJDL1.10.2	1SNA291472R2500	50	2.45
4 Terminal block markers	White	RC1010	1SNA238000R1600	1	1.30

Complete list of accessories is indicated in the terminal block datasheet. Some accessories such as jumper bars may modify the terminal block's ratings: complete information in the accessories catalogue pages.

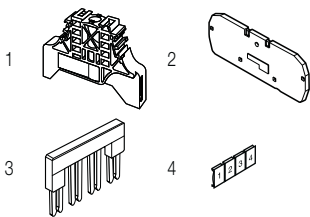

D16/12.P.2L spring terminal blocks

Ground with 2 connections - 12 mm 0.472 in spacing



16 mm²
6 AWG

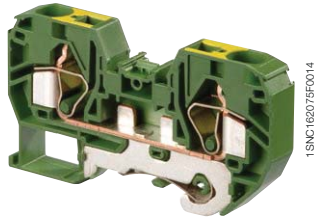

1SNC162075F0014

D16/12.P.2L

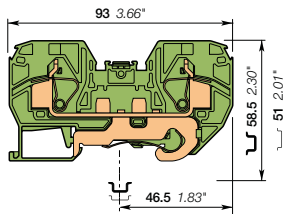

12 mm 0.472 in spacing

Description

- Improve the safety of your installation in the event of a short-circuit thanks to our screwless rail contact,
- Rail contact non operator dependent,
- Performances above the requirements of IEC 60947-7-2 terminal block standard,
- Secure snap on or remove from the rail.

Ordering details

Description	Color	Type	Order code	Pkg qty	Weight (1 pce)
Ground Screwless rail connection	Green-yellow	D16/12.P.2L	1SNA399584R2200	25	56.00

Main technical data

Connecting capacity		IEC	UL	CSA	Mounting instructions	
1 conductor per clamp	Rigid - Solid / Stranded	0.5-25 mm ²	20-6 AWG	20-4 AWG	Rail	TH 35-7.5, TH 35-15
	Flexible with non insulated ferrule	0.5-16 mm ²			Wire stripping length	19 mm 0.73 in
	with insulated ferrule				Tool	Flat screwdriver Ø 6.5 mm Ø 0.256 in
Gauge	A7					
Rated cross section		16.0 mm ²	6 AWG	4 AWG		
Rated short-time withstand current (1s)		1920 A				
Protection		IP20	NEMA 1			

The connecting capacity data for one Rigid - Solid / Stranded - Flexible conductor (when applicable) is a mandatory information required by IEC, UL and CSA standards. All other data are provided as supplementary information only. For more details, please consult our CB, UL or CSA certificates and technical datasheet available on <http://www.abb.com>



Accessories

Description	Color	Type	Order code	Pkg qty	Weight (1 pce)
1 End stops	Grey	BADL	1SNA399903R0200	50	4.70
		BAM2	1SNA206351R1600	50	12.00
2 End sections	Grey	FED12.2L	1SNA399571R0400	10	5.00
3 Jumper bars	Orange	BJDL12-2	1SNA399563R0400	25	7.00
4 Terminal block markers	White	RC1010	1SNA238000R1600	1	1.30

Complete list of accessories is indicated in the terminal block datasheet. Some accessories such as jumper bars may modify the terminal block's ratings: complete information in the accessories catalogue pages.

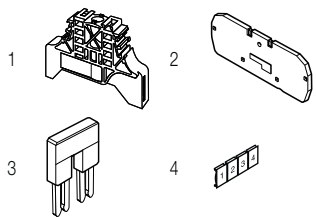

All the technical data for UL/CSA standard and dimensions in inches are in italic. Technical data valid for copper conductors only.

D16/12.P.3L spring terminal blocks

Ground with 3 connections - 12 mm 0.472 in spacing

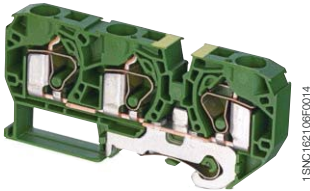

D16/12.P.3L

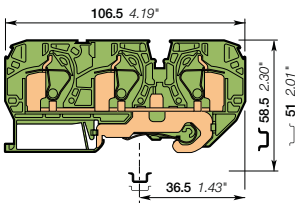

12 mm 0.472 in spacing

Description

- Improve the safety of your installation in the event of a short-circuit thanks to our screwless rail contact,
- Rail contact non operator dependent,
- Performances above the requirements of IEC 60947-7-2 terminal block standard,
- Secure snap on or remove from the rail.

Ordering details

Description	Color	Type	Order code	Pkg qty	Weight (1 pce) g
Ground Screwless rail connection	Green-yellow	D16/12.P.3L	1SNA290432R2000	10	72.00

Main technical data

Connecting capacity		IEC	UL	CSA	Mounting instructions	
1 conductor per clamp	Rigid - Solid / Stranded	0.5-25 mm ²		20-4 AWG	Rail	TH 35-7.5, TH 35-15
	Flexible with non insulated ferrule	0.5-16 mm ²			Wire stripping length	19 mm 0.72 in
	with insulated ferrule				Tool	Flat screwdriver Ø 6.5 mm Ø 0.256 in
	Gauge	A7				
Rated cross section		16.0 mm ²		4 AWG		
Rated short-time withstand current (1s)		1920 A				
Protection		IP20		NEMA1		

The connecting capacity data for one Rigid - Solid / Stranded - Flexible conductor (when applicable) is a mandatory information required by IEC, UL and CSA standards. All other data are provided as supplementary information only. For more details, please consult our CB, UL or CSA certificates and technical datasheet available on <http://www.abb.com>



Accessories

Description	Color	Type	Order code	Pkg qty	Weight (1 pce) g
1 End stops	Grey	BADL	1SNA399903R0200	50	4.70
		BAM2	1SNA206351R1600	50	12.00
2 End sections	Grey	FED12.3L	1SNA291721R2600	20	5.50
3 Jumper bars	Orange	BJDL12-2	1SNA399563R0400	25	7.00
4 Terminal block markers	White	RC1010	1SNA238000R1600	1	1.30

Complete list of accessories is indicated in the terminal block datasheet. Some accessories such as jumper bars may modify the terminal block's ratings: complete information in the accessories catalogue pages.

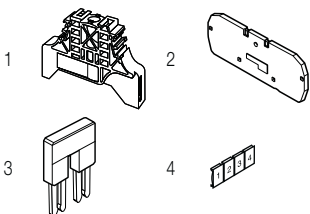

All the technical data for UL/CSA standard and dimensions in inches are in italic. Technical data valid for copper conductors only.

D35/16.P.2L spring terminal blocks

Ground with 2 connections - 16 mm 0.630 in spacing



D35/16.P.2L

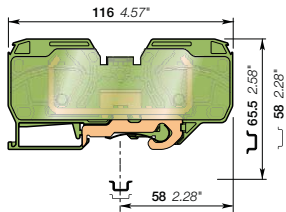

16 mm 0.630 in spacing

Description

- Improve the safety of your installation in the event of a short-circuit thanks to our screwless rail contact,
- Rail contact non operator dependent,
- Performances above the requirements of IEC 60947-7-2 terminal block standard,
- Secure snap on or remove from the rail.

Ordering details

Description	Color	Type	Order code	Pkg qty	Weight (1 pce)
Ground Screwless rail connection	Green-yellow	D35/16.P.2L	1SNA399620R1100	10	120.00

Main technical data

Connecting capacity	IEC	UL	CSA	Mounting instructions	
1 conductor per clamp	Rigid - Solid / Stranded	2.5-50 mm ²		Rail	TH 35-7.5, TH 35-15
	Flexible with non insulated ferrule	2.5-35 mm ²		Wire stripping length	26 mm 1.02 in
	with insulated ferrule			Tool	Flat screwdriver Ø 6.5 mm Ø 0.256 in
Gauge	A9				
Rated cross section	35.0 mm ²				
Rated short-time withstand current (1s)	4200 A				
Protection	IP20	NEMA 1			

The connecting capacity data for one Rigid - Solid / Stranded - Flexible conductor (when applicable) is a mandatory information required by IEC, UL and CSA standards. All other data are provided as supplementary information only. For more details, please consult our CB, UL or CSA certificates and technical datasheet available on <http://www.abb.com>

RoHS	RoHS	RoHS	RoHS	RoHS	RoHS	RoHS	RoHS	RoHS	RoHS

Accessories

Description	Color	Type	Order code	Pkg qty	Weight (1 pce)
1 End stops 12 mm 0.472 in	Grey	BADH	1SNA116900R2700	50	24.00
2 Jumper bars 2 poles 115 A	Orange	BJDL16-2	1SNA399621R0600	25	10.00
3 Terminal block markers Blank card	White	RC1010	1SNA238000R1600	1	1.30

Complete list of accessories is indicated in the terminal block datasheet. Some accessories such as jumper bars may modify the terminal block's ratings: complete information in the accessories catalogue pages.

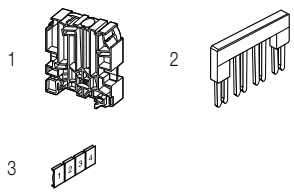

All the technical data for UL/CSA standard and dimensions in inches are in italic. Technical data valid for copper conductors only.

D2.5/5.D2.L spring terminal blocks

Double deck - 5 mm 0.197 in spacing



2.5 mm²
12 AWG

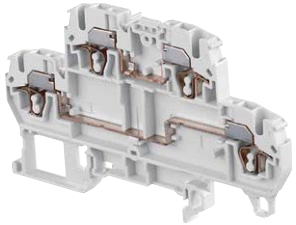

1SNC162015R0014

D2.5/5.D2.L

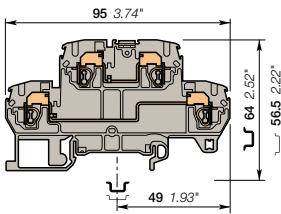

5 mm 0.197 in spacing

Description

- Save space with double deck terminal block in just 5 mm 0.197 in spacing,
- Easy to access thanks to its front wiring entry,
- Clamping contact pressure non dependent on the operator and automatic creeping compensation,
- Numerous built-in functions: jumper system, clearly visible top marker, test sockets, etc.

Ordering details

Description	Color	Type	Order code	Pkg qty	Weight (1 pce) g
Feed-through 2 feed-through circuits, 4 connections	Grey <input type="checkbox"/>	D2.5/5.D2.L	1SNA290161R0000	50	13.00
	Blue <input type="checkbox"/>	D2.5/5.D2.N.L	1SNA290163R0200	50	13.00

Main technical data

Connecting capacity	IEC	UL	CSA
1 conductor per clamp	Rigid - Solid / Stranded	0.12-4 mm ²	26-12 AWG
	Flexible with non insulated ferrule	0.12-2.5 mm ²	26-12 AWG
	with insulated ferrule		
Gauge	A2		
Rated current / Rated cross section	20 A / 2.5 mm ²	20 A / 12 AWG	20 A / 12 AWG
Rated short-time withstand current (1s)	300 A		
Rated voltage	500 V	300 V	300 V
Impulse withstand voltage	6000 V		
Protection	IP20	NEMA 1	

Mounting instructions

Rail		TH 35-7.5, TH 35-15
Wire stripping length		9.5 mm 0.37 in
Tool		Flat screwdriver Ø 3.5 mm Ø 0.138 in

The connecting capacity data for one Rigid - Solid / Stranded - Flexible conductor (when applicable) is a mandatory information required by IEC, UL and CSA standards. All other data are provided as supplementary information only. For more details, please consult our CB, UL or CSA certificates and technical datasheet available on <http://www.abb.com>

RoHS	RoHS	UL	UL	CSA	CSA	PC	PC
RoHS	RoHS	UL	UL	CSA	CSA	PC	PC

Notes

Mounting of the inner deck jumper bar between decks (ITVE.L).

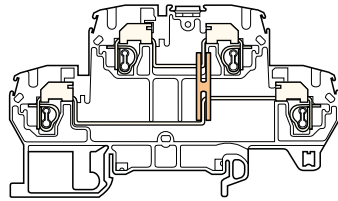

Accessories

Description	Color	Type	Order code	Pkg qty	Weight (1 pce) g
1 End stops 12 mm 0.472 in	Grey <input type="checkbox"/>	BADH	1SNA116900R2700	50	24.00
2 End sections 2.5 mm 0.098 in	Grey <input type="checkbox"/>	FED5.D.L	1SNA291441R2600	20	4.20
3 Jumper bars 2 poles 24 A	Orange <input type="checkbox"/>	BJDL5-2	1SNA291102R2300	50	1.00
		BJDL5-3	1SNA291103R2400	50	0.70
		BJDL5-4	1SNA291104R2500	50	0.80
		BJDL5-5	1SNA291105R2600	20	0.90
		BJDL5-10	1SNA291110R2600	20	1.20
4 Test plugs DIA 2 mm 0.079 in	Black <input type="checkbox"/>	FC2.MC	1SNA107239R0300	20	1.00
5 Inner deck jumper bars		ITVE.L	1SNA291349R1100	50	0.40
6 Terminal block markers Blank card	White <input type="checkbox"/>	RC510	1SNA231000R0700	1	5.20

Complete list of accessories is indicated in the terminal block datasheet. Some accessories such as jumper bars may modify the terminal block's ratings: complete information in the accessories catalogue pages.

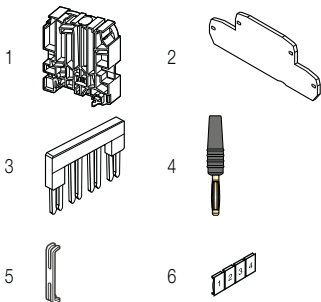

D2.5/5.T3.L spring terminal blocks

Triple deck - 5 mm 0.197 in spacing



2.5 mm²
12 AWG

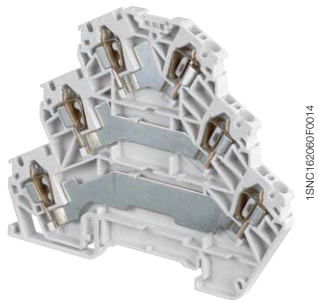

D2.5/5.T3.L

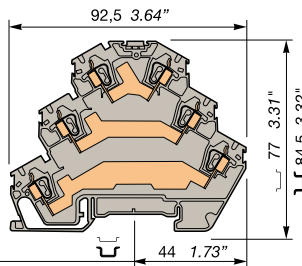

5 mm 0.197 in spacing

Description

- Save space with triple deck terminal block in just 5 mm 0.197 in spacing,
- Easy to access thanks to its front wiring entry,
- Clamping contact pressure non dependent on the operator and automatic creeping compensation,
- Numerous built-in functions: jumper system, clearly visible top marker, test sockets, etc.

Ordering details

Description	Color	Type	Order code	Pkg qty	Weight (1 pce)
Feed-through 3 feed-through circuits, 6 connections	Grey <input type="checkbox"/>	D2.5/5.T3.L	1SNA290456R0000	25	20.20

Main technical data

Connecting capacity		IEC	UL	CSA	Mounting instructions	
1 conductor per clamp	Rigid - Solid / Stranded	0.14-4 mm ²	24-14 AWG	24-14 AWG	Rail	TH 35-7.5, TH 35-15
	Flexible with non insulated ferrule	0.14-2.5 mm ²			Wire stripping length	9.5 mm 0.37 in
	Flexible with insulated ferrule				Tool	Flat screwdriver Ø 3.5 mm Ø 0.138 in
Gauge	A2					
Rated current / Rated cross section		20 A / 2.5 mm ²	15 A / 14 AWG	16 A / 14 AWG		
Rated short-time withstand current (1s)		300 A				
Rated voltage		500 V	150 V	150 V		
Impulse withstand voltage		6000 V				
Protection		IP20	NEMA 1			

The connecting capacity data for one Rigid - Solid / Stranded - Flexible conductor (when applicable) is a mandatory information required by IEC, UL and CSA standards. All other data are provided as supplementary information only. For more details, please consult our CB, UL or CSA certificates and technical datasheet available on <http://www.abb.com>

RoHS <input type="checkbox"/>	UL <input type="checkbox"/>	CSA <input type="checkbox"/>	Gost R <input type="checkbox"/>
-------------------------------	-----------------------------	------------------------------	---------------------------------

Accessories

Description	Color	Type	Order code	Pkg qty	Weight (1 pce)	
1 End stops 12 mm	Grey <input type="checkbox"/>	BADH	1SNA116900R2700	50	24.00	
2 End sections 2.5 mm	Grey <input type="checkbox"/>	FED5.T3.L	1SNA291817R1700	20	6.60	
3 Jumper bars 2 poles 24 A	Orange <input type="checkbox"/>	3 poles	BJDL5-2	1SNA291102R2300	50	1.00
		4 poles	BJDL5-3	1SNA291103R2400	50	0.70
		5 poles	BJDL5-4	1SNA291104R2500	50	0.80
		10 poles	BJDL5-5	1SNA291105R2600	20	0.90
		10 poles	BJDL5-10	1SNA291110R2600	20	1.20
4 Test plugs DIA 2 mm 0.079 in	Black <input type="checkbox"/>	FC2.MC	1SNA107239R0300	20	1.00	
5 Terminal block markers Blank card	White <input type="checkbox"/>	RC510	1SNA231000R0700	1	5.20	

Complete list of accessories is indicated in the terminal block datasheet. Some accessories such as jumper bars may modify the terminal block's ratings: complete information in the accessories catalogue pages.

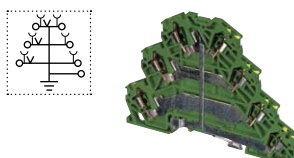
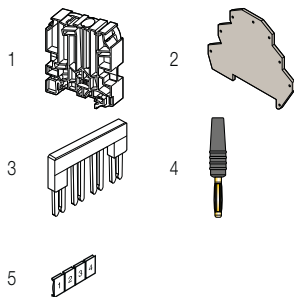

Ground spring terminal blocks

Description	Color	Type	Order code	Pkg qty	Weight (1 pce)
Ground	Green-yellow <input type="checkbox"/>	D2.5/5.T1.PL	1SNA290459R1300	25	25.80

All the technical data for UL/CSA standard and dimensions in inches are in italic. Technical data valid for copper conductors only.

D2.5/5.T3.P.L spring terminal blocks

Triple deck + ground - 5 mm 0.197 in spacing



D2.5/5.T3.P.L

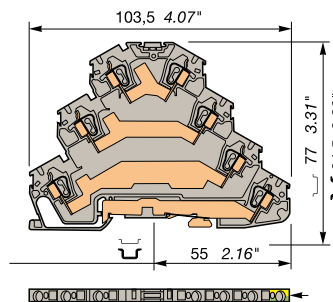

5 mm 0.197 in spacing

Description

- Save space with triple deck terminal block in just 5 mm 0.197 in spacing,
- Easy to access thanks to its front wiring entry,
- Clamping contact pressure non dependent on the operator and automatic creeping compensation,
- Numerous built-in functions: jumper system, clearly visible top marker, test sockets, etc.

Ordering details

Description	Color	Type	Order code	Pkg qty	Weight (1 pce) g
Feed-through + ground 3 feed-through circuits + 1 ground, 7 connections	Grey, Green-Yellow	D2.5/5.T3.PL	1SNA290458R1200	25	24.40

Main technical data

Connecting capacity	IEC	UL	CSA	Mounting instructions	
1 conductor per clamp				Rail	TH 35-7.5, TH 35-15
Rigid - Solid / Stranded	0.14-4 mm ²	24-14 AWG	24-14 AWG	Wire stripping length	9.5 mm 0.37 in
Flexible	0.14-2.5 mm ²			Tool	Flat screwdriver Ø 3.5 mm Ø 0.138 in
with non insulated ferrule					
with insulated ferrule					
Gauge	A2				
Rated current / Rated cross section	20 A / 2.5 mm ²	/ 14 AWG	/ 14 AWG		
Rated short-time withstand current (1s)	300 A				
Rated voltage	500 V				
Impulse withstand voltage	6000 V				
Protection	IP20	NEMA 1			

The connecting capacity data for one Rigid - Solid / Stranded - Flexible conductor (when applicable) is a mandatory information required by IEC, UL and CSA standards. All other data are provided as supplementary information only. For more details, please consult our CB, UL or CSA certificates and technical datasheet available on <http://www.abb.com>

RoHS	ULSR	CSA	Gost R																
------	------	-----	--------	--	--	--	--	--	--	--	--	--	--	--	--	--	--	--	--

Accessories

Description	Color	Type	Order code	Pkg qty	Weight (1 pce) g
1 End stops	Grey	BADH	1SNA116900R2700	50	24.00
2 End sections	Grey	FED5.T3.PL	1SNA291818R2000	20	7.20
3 Jumper bars	Orange	BJDL5-2	1SNA291102R2300	50	1.00
		BJDL5-3	1SNA291103R2400	50	0.70
		BJDL5-4	1SNA291104R2500	50	0.80
		BJDL5-5	1SNA291105R2600	20	0.90
		BJDL5-10	1SNA291110R2600	20	1.20
4 Test plugs	Black	FC2.MC	1SNA107239R0300	20	1.00
5 Terminal block markers	White	RC510	1SNA231000R0700	1	5.20

Complete list of accessories is indicated in the terminal block datasheet. Some accessories such as jumper bars may modify the terminal block's ratings: complete information in the accessories catalogue pages.

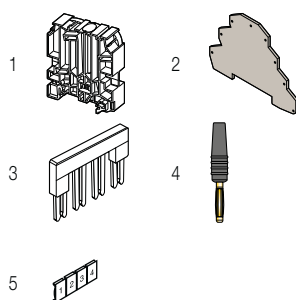

All the technical data for UL/CSA standard and dimensions in inches are in italic. Technical data valid for copper conductors only.

D2.5/5.T1.L spring terminal blocks

Triple deck - 5 mm 0.197 in spacing



2.5 mm²
12 AWG

Description

- Save space with triple deck terminal block in just 5 mm 0.197 in spacing,
- Easy to access thanks to its front wiring entry,
- Clamping contact pressure non dependent on the operator and automatic creeping compensation,
- Numerous built-in functions: jumper system, clearly visible top marker, test sockets, etc.

Ordering details

Description	Color	Type	Order code	Pkg qty	Weight (1 pce)
Feed-through 1 feed-through circuit, 6 connections	Black ■	D2.5/5.T1.L	1SNA290457R0100	25	21.60

Main technical data

Connecting capacity		IEC	UL	CSA	Mounting instructions	
1 conductor per clamp	Rigid - Solid / Stranded	0.14-4 mm ²	24-14 AWG	24-14 AWG	Rail	TH 35-7.5, TH 35-15
	Flexible with non insulated ferrule	0.14-2.5 mm ²			Wire stripping length	9.5 mm 0.37 in
	Flexible with insulated ferrule				Tool	Flat screwdriver Ø 3.5 mm Ø 0.138 in
Gauge	A2					
Rated current / Rated cross section		24 A / 2.5 mm ²	15 A / 14 AWG	20 A / 14 AWG		
Rated short-time withstand current (1s)		300 A				
Rated voltage		500 V	150 V	150 V		
Impulse withstand voltage		6000 V				
Protection		IP20	NEMA 1			

The connecting capacity data for one Rigid - Solid / Stranded - Flexible conductor (when applicable) is a mandatory information required by IEC, UL and CSA standards. All other data are provided as supplementary information only. For more details, please consult our CB, UL or CSA certificates and technical datasheet available on <http://www.abb.com>



D2.5/5.T1.L

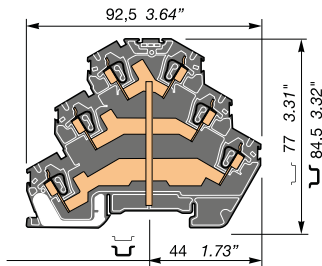

5 mm 0.197 in spacing

Accessories

Description	Color	Type	Order code	Pkg qty	Weight (1 pce)
1 End stops 12 mm 0.472 in	Grey □	BADH	1SNA116900R2700	50	24.00
2 End sections 2.5 mm 0.098 in	Grey □	FED5.T3.L	1SNA291817R1700	20	6.60
3 Jumper bars 2 poles 24 A	Orange ■	BJDL5-2	1SNA291102R2300	50	1.00
		BJDL5-3	1SNA291103R2400	50	0.70
		BJDL5-4	1SNA291104R2500	50	0.80
		BJDL5-5	1SNA291105R2600	20	0.90
		BJDL5-10	1SNA291110R2600	20	1.20
4 Test plugs DIA 2 mm 0.079 in	Black ■	FC2.MC	1SNA107239R0300	20	1.00
5 Terminal block markers Blank card	White □	RC510	1SNA231000R0700	1	5.20

Complete list of accessories is indicated in the terminal block datasheet. Some accessories such as jumper bars may modify the terminal block's ratings: complete information in the accessories catalogue pages.

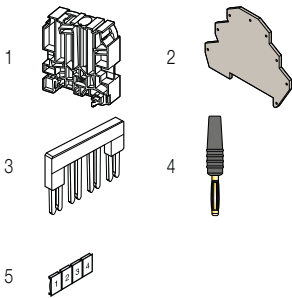

Ground spring terminal blocks

Description	Color	Type	Order code	Pkg qty	Weight (1 pce)
Ground	Green-yellow ■	D2.5/5.T1.PL	1SNA290459R1300	25	25.80

All the technical data for UL/CSA standard and dimensions in inches are in italic. Technical data valid for copper conductors only.

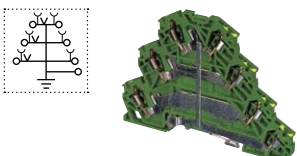

D2.5/5.T1.P.L spring terminal blocks

Ground with 7 connections - 5 mm 0.197 in spacing



2.5 mm²
12 AWG



D2.5/5.T1.P.L

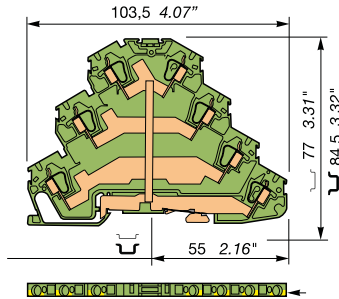

5 mm 0.197 in spacing

Description

- Save space with triple terminal block in just 5 mm 0.197 in spacing,
- Easy to access thanks to its front wiring entry,
- Clamping contact pressure non dependent on the operator and automatic creeping compensation.

Ordering details

Description	Color	Type	Order code	Pkg qty	Weight (1 pce) g
Ground Screwless rail connection	Green-yellow	D2.5/5.T1.PL	1SNA290459R1300	25	25.80

Main technical data

Connecting capacity		IEC	UL	CSA	Mounting instructions	
1 conductor per clamp	Rigid - Solid / Stranded	0.14-4 mm ²	24-14 AWG	24-14 AWG	Rail	TH 35-7.5, TH 35-15
	Flexible with non insulated ferrule	0.14-2.5 mm ²			Wire stripping length	9.5 mm 0.37 in
	with insulated ferrule				Tool	Flat screwdriver Ø 3.5 mm Ø 0.138 in
	Gauge	A2				
Rated cross section		2.5 mm ²	14 AWG	14 AWG		
Rated short-time withstand current (1s)		300 A				
Protection		IP20	NEMA 1			

The connecting capacity data for one Rigid - Solid / Stranded - Flexible conductor (when applicable) is a mandatory information required by IEC, UL and CSA standards. All other data are provided as supplementary information only. For more details, please consult our CB, UL or CSA certificates and technical datasheet available on <http://www.abb.com>



Accessories

Description	Color	Type	Order code	Pkg qty	Weight (1 pce) g
1 End stops 12 mm 0.472 in	Grey	BADH	1SNA116900R2700	50	24.00
2 End sections 2.5 mm 0.098 in	Grey	FED5.T3.PL	1SNA291818R2000	20	7.20
3 Test plugs DIA 2 mm 0.079 in	Black	FC2.MC	1SNA107239R0300	20	1.00
4 Terminal block markers Blank card	White	RC510	1SNA231000R0700	1	5.20

Complete list of accessories is indicated in the terminal block datasheet. Some accessories such as jumper bars may modify the terminal block's ratings: complete information in the accessories catalogue pages.

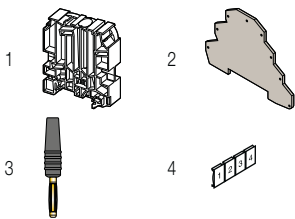

All the technical data for UL/CSA standard and dimensions in inches are in italic. Technical data valid for copper conductors only.

D2.5/5.SNBT.2L spring terminal blocks

Disconnect with blade - with test socket - 5 mm 0.197 in spacing



2.5 mm²
12 AWG

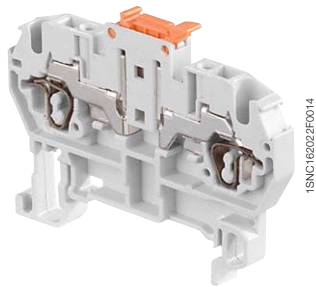

1SNIC16202F0014

D2.5/5.SNBT.2L

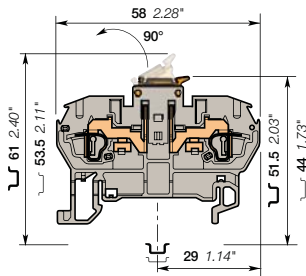

5 mm 0.197 in spacing

Description

- Ease your disconnect operations with the disconnect knife blade operated by hand or with a screwdriver,
- Easy to access thanks to its front wiring entry,
- Clamping contact pressure non dependent on the operator and automatic creeping compensation,
- Numerous built-in functions: double jumper system, clearly visible top marker, test sockets, etc,
- Functional through ergonomic design (alignment).

Ordering details

Description	Color	Type	Order code	Pkg qty	Weight (1 pce) g
Disconnect 2 connections	Grey, orange	D2.5/5.SNBT.2L	1SNA290041R0300	50	7.00
	Blue, orange	D2.5/5.SNBT.2L	1SNA290044R0600	50	7.00
	Orange, orange	D2.5/5.SNBT.2L	1SNA290042R0400	50	7.00

Main technical data

Connecting capacity		IEC	UL	CSA	Mounting instructions	
1 conductor per clamp	Rigid - Solid / Stranded	0.12-4 mm ²	26-12 AWG	26-12 AWG	Rail	TH 35-7.5, TH 35-15
	Flexible with non insulated ferrule	0.12-2.5 mm ²			Wire stripping length	9.5 mm 0.37 in
	with insulated ferrule				Tool	Flat screwdriver Ø 3.5 mm Ø 0.138 in
	Gauge	A2				
Rated current / Rated cross section		10 A / 2.5 mm ²	8 A / 12 AWG	8 A / 12 AWG		
Rated short-time withstand current (1s)		120 A				
Rated voltage		500 V	600 V	600 V		
Impulse withstand voltage		6000 V				
Protection		IP20	NEMA 1			

The connecting capacity data for one Rigid - Solid / Stranded - Flexible conductor (when applicable) is a mandatory information required by IEC, UL and CSA standards. All other data are provided as supplementary information only. For more details, please consult our CB, UL or CSA certificates and technical datasheet available on <http://www.abb.com>



Accessories

Description	Color	Type	Order code	Pkg qty	Weight (1 pce) g	
1 End stops	Grey	BADL	1SNA399903R0200	50	4.70	
		BAM2	1SNA206351R1600	50	12.00	
2 End sections	Grey	FED5.2L	1SNA291061R2400	20	2.00	
3 Jumper bars	Orange	2 poles 24 A	BJDL5-2	1SNA291102R2300	50	1.00
		3 poles	BJDL5-3	1SNA291103R2400	50	0.70
		4 poles	BJDL5-4	1SNA291104R2500	50	0.80
		5 poles	BJDL5-5	1SNA291105R2600	20	0.90
		10 poles	BJDL5-10	1SNA291110R2600	20	1.20
4 Cross spacing jumpers	Orange	5 mm 0.200 in - 6 mm 0.236 in	BJDPL5.6-2	1SNA291150R0600	20	0.20
		5 mm 0.200 in - 8 mm 0.315 in	BJDPL5.8-2	1SNA291160R0000	20	1.65
		5 mm 0.200 in - 10 mm 0.400 in	BJDPL5.10-2	1SNA291480R2200	20	0.50
5 Test plugs	Black	FC2.MC	1SNA107239R0300	20	1.00	
6 Shield connectors		CBD5.2L	1SNA291077R2400	50	2.00	
7 Terminal block markers	White	RC510	1SNA231000R0700	1	5.20	

Complete list of accessories is indicated in the terminal block datasheet. Some accessories such as jumper bars may modify the terminal block's ratings: complete information in the accessories catalogue pages.

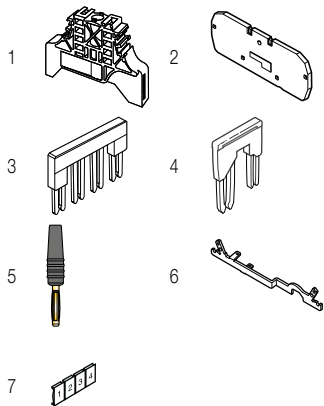

Feed-through spring terminal blocks

Description	Color	Type	Order code	Pkg qty	Weight (1 pce) g
Feed-through	Grey	D2.5/5.2L	1SNA290021R2700	50	6.00

All the technical data for UL/CSA standard and dimensions in inches are in *italics*. Technical data valid for copper conductors only.

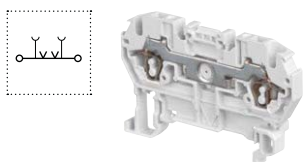

D2.5/5.SNBT.4L spring terminal blocks

Disconnect with blade - with test socket - 5 mm 0.197 in spacing

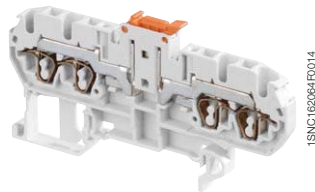

D2.5/5.SNBT.4L

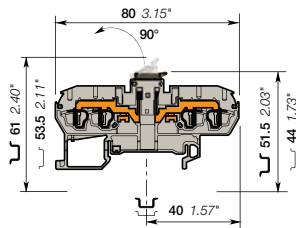

5 mm 0.197 in spacing

Description

- Ease your disconnect operations with the disconnect knife blade operated by hand or with a screwdriver,
- Easy to access thanks to its front wiring entry,
- Clamping contact pressure non dependent on the operator and automatic creeping compensation,
- Numerous built-in functions: double jumper system, clearly visible top marker, test sockets, etc,
- Functional through ergonomic design (alignment).

Ordering details

Description	Color	Type	Order code	Pkg qty	Weight (1 pce) g
Disconnect 4 connections	Grey, orange	D2.5/5.SNBT.4L	1SNA290131R2200	50	10.00
	Blue, orange	D2.5/5.SNBT.N.4L	1SNA290134R2500	50	10.00
	Orange, orange	D2.5/5.SNBT.4L	1SNA290132R2300	50	10.00

Main technical data

Connecting capacity	IEC	UL	CSA
1 conductor per clamp	Rigid - Solid / Stranded	0.12-4 mm ²	26-12 AWG
	Flexible	0.12-2.5 mm ²	
	with non insulated ferrule		
	with insulated ferrule		
	Gauge	A2	
Rated current / Rated cross section	10 A / 2.5 mm ²		20 A / 12 AWG
Rated short-time withstand current (1s)	120 A		
Rated voltage	500 V		300 V
Impulse withstand voltage	6000 V		
Protection	IP20		NEMA 1

Mounting instructions

Rail		TH 35-7.5, TH 35-15
Wire stripping length		9.5 mm 0.37 in
Tool		Flat screwdriver Ø 3.5 mm Ø 0.138 in

The connecting capacity data for one Rigid - Solid / Stranded - Flexible conductor (when applicable) is a mandatory information required by IEC, UL and CSA standards. All other data are provided as supplementary information only. For more details, please consult our CB, UL or CSA certificates and technical datasheet available on <http://www.abb.com>

RoHS		cCSAus	Gost R
------	--	--------	--------

Accessories

Description	Color	Type	Order code	Pkg qty	Weight (1 pce) g	
1 End stops	Grey	BADL	1SNA399903R0200	50	4.70	
		BAM2	1SNA206351R1600	50	12.00	
2 End sections	Grey	FED5.4L	1SNA291041R2000	20	2.20	
3 Jumper bars	Orange	2 poles	BJDL5-2	1SNA291102R2300	50	1.00
		3 poles	BJDL5-3	1SNA291103R2400	50	0.70
		4 poles	BJDL5-4	1SNA291104R2500	50	0.80
		5 poles	BJDL5-5	1SNA291105R2600	20	0.90
		10 poles	BJDL5-10	1SNA291110R2600	20	1.20
		4 Cross spacing jumpers	Orange	5 mm 0.200 in - 6 mm 0.236 in	BJDPL5.6-2	1SNA291150R0600
5 mm 0.200 in - 8 mm 0.315 in	BJDPL5.8-2			1SNA291160R0000	20	1.65
5 mm 0.200 in - 10 mm 0.400 in	BJDPL5.10-2			1SNA291480R2200	20	0.50
5 Test plugs	Black	FC2.MC	1SNA107239R0300	20	1.00	
6 Terminal block markers	White	RC510	1SNA231000R0700	1	5.20	

Complete list of accessories is indicated in the terminal block datasheet. Some accessories such as jumper bars may modify the terminal block's ratings: complete information in the accessories catalogue pages.

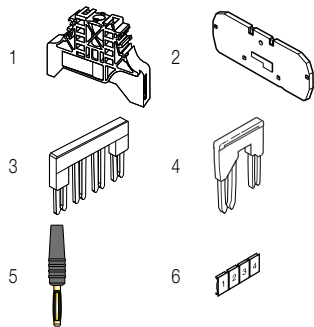

Feed-through spring terminal blocks

Description	Color	Type	Order code	Pkg qty	Weight (1 pce) g
Feed-through	Grey	D2.5/5.4L	1SNA290011R2500	50	8.00

All the technical data for UL/CSA standard and dimensions in inches are in *italics*. Technical data valid for copper conductors only.



D2.5/8.SF.2L spring terminal blocks

For 5 x 20 and 5 x 25 fuses - with test socket - 8 mm 0.315 in spacing



2.5 mm²
12 AWG

Description

- Protect your circuits with 5 x 20 and 5x 25 fuse terminal blocks (fuse not supplied with the terminal blocks),
- Easy to access thanks to its front wiring entry,
- Clamping contact pressure non dependent on the operator and automatic creeping compensation.

Ordering details

Description	Color	Type	Order code	Pkg qty	Weight (1 pce) g
Fuse	Grey	D2.5/8.SFT.2L	1SNA290091R2600	50	14.00
	Orange	D2.5/8.SFT.2L	1SNA290092R2700	50	14.00

Main technical data

Connecting capacity	IEC	UL	CSA	Mounting instructions	
1 conductor per clamp	Rigid - Solid / Stranded	0.12-4 mm ²	26-12 AWG	Rail	TH 35-7.5, TH 35-15
	Flexible with non insulated ferrule with insulated ferrule	0.12-2.5 mm ²		Wire stripping length	9.5 mm 0.37 in
	Gauge	A2		Tool	Flat screwdriver Ø 3.5 mm Ø 0.138 in
Rated current / Rated cross section	6.3 A / 2.5 mm ²	8 A / 12 AWG	8 A / 12 AWG		
Rated short-time withstand current (1s)					
Rated voltage	630 V	600 V	600 V		
Impulse withstand voltage	8000 V				
Protection	IP20	NEMA 1			

The connecting capacity data for one Rigid - Solid / Stranded - Flexible conductor (when applicable) is a mandatory information required by IEC, UL and CSA standards. All other data are provided as supplementary information only. For more details, please consult our CB, UL or CSA certificates and technical datasheet available on <http://www.abb.com>

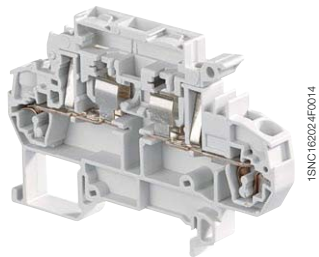

D2.5/8.SF.2L

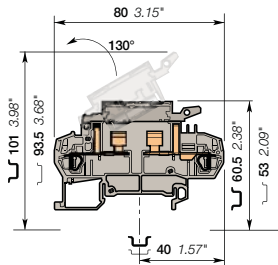

8 mm 0.315 in spacing

Accessories

Description	Color	Type	Order code	Pkg qty	Weight (1 pce) g	
1 End stops	Grey	BADL	1SNA399903R0200	50	4.70	
		BAM2	1SNA206351R1600	50	12.00	
2 End sections	Grey	FED8SF.2L	1SNA291131R1700	20	3.50	
3 Jumper bars	Orange	2 poles	BJDL8-2	1SNA291122R1600	50	0.20
		3 poles	BJDL8-3	1SNA291123R1700	50	0.40
		4 poles	BJDL8-4	1SNA291144R2400	50	0.50
		5 poles	BJDL8-5	1SNA291145R2500	20	3.90
		4 Cross spacing jumpers	Orange	BJDPL5.8-2	1SNA291160R0000	20
		BJDPL6.8-2	1SNA291170R0200	20	0.20	
		BJDPL8.10-2	1SNA291484R1200	20	1.50	
5 Test plugs	Black	FC2.MC	1SNA107239R0300	20	1.00	
6 Fuses		FU520	1SNA008288R1500	10		
			1SNA008290R1300	10		
			1SNA008291R0000	10		
			1SNA168672R1100	10	1.00	
7 Assembly rods		TGA8	1SNA168673R1200	10		
			1SNA168674R1300	10		
			1SNA168675R1400	10		
8 Spring retaining rings		ANT	1SNA168675R1400	10		
9 Terminal block markers	White	RC610	1SNA233000R0100	1	7.50	

Complete list of accessories is indicated in the terminal block datasheet.

Some accessories such as jumper bars may modify the terminal block's ratings: complete information in the accessories catalogue pages.

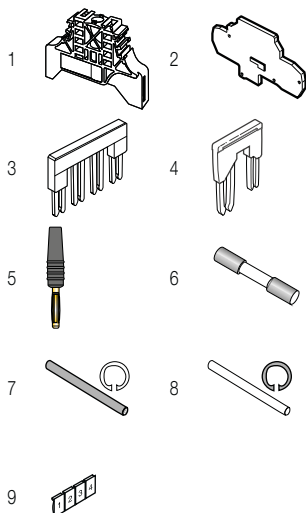

Disconnect spring terminal blocks

Description	Color	Type	Order code	Pkg qty	Weight (1 pce) g
Disconnect	Grey, blue	D2.5/8.SNT.2L	1SNA290097R2400	50	15.00

All the technical data for UL/CSA standard and dimensions in inches are in italic. Technical data valid for copper conductors only.

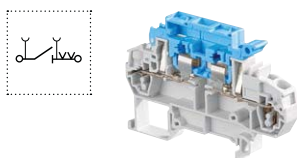

D2.5/8.SF.2L spring terminal blocks

For 5 x 20 and 5 x 25 fuses - with blown fuse indicator and test sockets - 8 mm 0.315 in spacing

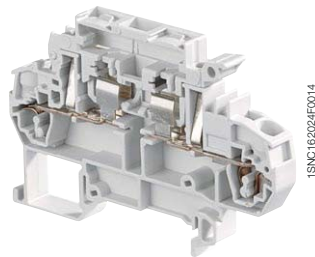

D2.5/8.SF.2L

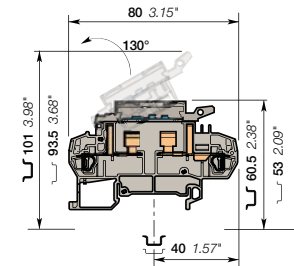

8 mm 0.315 in spacing

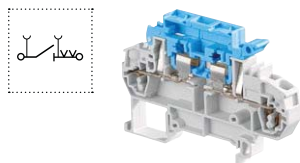
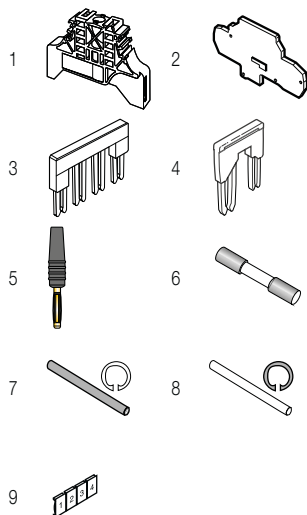

Description

- Protect your circuits with 5 x 20 and 5x 25 fuse terminal blocks (fuse not delivered with the terminal blocks),
- Quickly identify the defective circuit thanks to the blown fuse indicator,
- Easy to access thanks to the front wiring entry,
- Clamping contact pressure non dependent on the operator and automatic creeping compensation.

Ordering details

Description	Color	Type	Order code	Pkg qty	Weight (1 pce) g
Fuse With blown fuse indicator by neon lamp 110-230 V AC and 2 test sockets DIA 2 mm 0.079 in	Grey <input type="checkbox"/>	D2.5/8.SFLT.2L	1SNA290093R2000	50	15.00
With blown fuse indicator by LED 24 VAC/DC and 2 test sockets DIA 2 mm 0.079 in	Grey <input type="checkbox"/>	D2.5/8.SFDT.2L	1SNA290094R2100	50	15.00

Main technical data

Connecting capacity	IEC	UL	CSA
1 conductor per clamp	Rigid - Solid / Stranded	0.12-4 mm ²	26-12 AWG
	Flexible	0.12-2.5 mm ²	26-12 AWG
	with non insulated ferrule with insulated ferrule Gauge	A2	
Rated current / Rated cross section	6.3 A / 2.5 mm ²	8 A / 12 AWG	8 A / 12 AWG
Rated short-time withstand current (1s)			
Rated voltage	630 V	600 V	600 V
Impulse withstand voltage	8000 V		
Protection	IP20	NEMA 1	

Mounting instructions

Rail		TH 35-7.5, TH 35-15
Wire stripping length		9.5 mm 0.37 in
Tool		Flat screwdriver Ø 3.5 mm Ø 0.138 in

The connecting capacity data for one Rigid - Solid / Stranded - Flexible conductor (when applicable) is a mandatory information required by IEC, UL and CSA standards. All other data are provided as supplementary information only. For more details, please consult our CB, UL or CSA certificates and technical datasheet available on <http://www.abb.com>



Notes

Leakage current: 24 V: < 4.5 mA
110 V: < 0.5 mA
230 V: < 0.7 mA

Accessories

Description	Color	Type	Order code	Pkg qty	Weight (1 pce) g	
1 End stops	Grey <input type="checkbox"/>	BADL	1SNA399903R0200	50	4.70	
		BAM2	1SNA206351R1600	50	12.00	
2 End sections	Grey <input type="checkbox"/>	FED8SF.2L	1SNA291131R1700	20	3.50	
3 Jumper bars	Orange <input type="checkbox"/>	2 poles	BJDL8-2	1SNA291122R1600	50	0.20
		3 poles	BJDL8-3	1SNA291123R1700	50	0.40
		4 poles	BJDL8-4	1SNA291144R2400	50	0.50
		5 poles	BJDL8-5	1SNA291145R2500	20	3.90
		5 mm 0.200 in - 8 mm 0.315 in	BJDPL5.8-2	1SNA291160R0000	20	1.65
4 Cross spacing jumpers	Orange <input type="checkbox"/>	6 mm 0.236 in - 8 mm 0.315 in	BJDPL6.8-2	1SNA291170R0200	20	0.20
		8 mm 0.315 in - 10 mm 0.400 in	BJDPL8.10-2	1SNA291484R1200	20	1.50
5 Test plugs	Black <input type="checkbox"/>	FC2.MC	1SNA107239R0300	20	1.00	
6 Fuses		0.5 A	FU520	1SNA008288R1500	10	
		1 A		1SNA008290R1300	10	
		2 A		1SNA008291R0000	10	
7 Assembly rods		2 poles	TGA8	1SNA168672R1100	10	1.00
		3 poles		1SNA168673R1200	10	
		4 poles		1SNA168674R1300	10	
8 Spring retaining rings		ANT	1SNA168675R1400	10		
9 Terminal block markers	Blank card	White <input type="checkbox"/>	RC610	1SNA233000R0100	1	7.50

Complete list of accessories is indicated in the terminal block datasheet. Some accessories such as jumper bars may modify the terminal block's ratings: complete information in the accessories catalogue pages.

Disconnect spring terminal blocks

Description	Color	Type	Order code	Pkg qty	Weight (1 pce) g
Disconnect Profile aligned with D2.5/8.SF..	Grey, blue <input type="checkbox"/>	D2.5/8.SNT.2L	1SNA290097R2400	50	15.00

All the technical data for UL/CSA standard and dimensions in inches are in *italics*. Technical data valid for copper conductors only.

D2.5/8.SNT.2L spring terminal blocks

Disconnect with lever - 8 mm 0.315 in spacing



Description

Save space with compact overall dimensions terminal blocks,
- Link bar for lever included in terminal block.

Ordering details

Description	Color	Type	Order code	Pkg qty	Weight (1 pce) g
Disconnect 2 connections	Grey, blue	D2.5/8.SNT.2L	1SNA290097R2400	50	15.00

Main technical data

Connecting capacity		IEC	UL	CSA	Mounting instructions	
1 conductor per clamp	Rigid - Solid / Stranded	0.12-4 mm ²	26-12 AWG	26-12 AWG	Rail	TH 35-7.5, TH 35-15
	Flexible with non insulated ferrule	0.12-2.5 mm ²			Wire stripping length	9.5 mm 0.37 in
	Flexible with insulated ferrule				Tool	Flat screwdriver Ø 3.5 mm Ø 0.138 in
	Gauge	A2				
Rated current / Rated cross section		6.3 A / 2.5 mm ²	8 A / 12 AWG	8 A / 12 AWG		
Rated short-time withstand current (1s)		90 A				
Rated voltage		630 V	600 V	600 V		
Impulse withstand voltage		8000 V				
Protection		IP20	NEMA 1			

The connecting capacity data for one Rigid - Solid / Stranded - Flexible conductor (when applicable) is a mandatory information required by IEC, UL and CSA standards. All other data are provided as supplementary information only. For more details, please consult our CB, UL or CSA certificates and technical datasheet available on <http://www.abb.com>

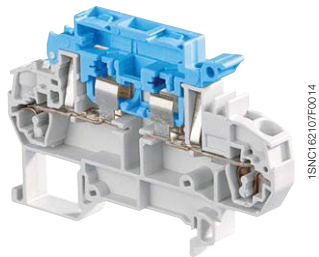

D2.5/8.SNT.2L

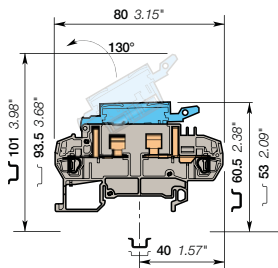

8 mm 0.315 in spacing

Accessories

Description	Color	Type	Order code	Pkg qty	Weight (1 pce) g		
1 End stops	Grey	BADL	1SNA399903R0200	50	4.70		
		BAM2	1SNA206351R1600	50	12.00		
2 End sections	Grey	FED8SF.2L	1SNA291131R1700	20	3.50		
3 Jumper bars	Orange	2 poles	41 A	BJDL8-2	1SNA291122R1600	50	0.20
		3 poles		BJDL8-3	1SNA291123R1700	50	0.40
		4 poles		BJDL8-4	1SNA291144R2400	50	0.50
		5 poles		BJDL8-5	1SNA291145R2500	20	3.90
		4 Cross spacing jumpers	Orange	5 mm 0.200 in - 8 mm 0.315 in	BJDPL5.8-2	1SNA291160R0000	20
		6 mm 0.236 in - 8 mm 0.315 in	BJDPL6.8-2	1SNA291170R0200	20	0.20	
		8 mm 0.315 in - 10 mm 0.400 in	BJDPL8.10-2	1SNA291484R1200	20	1.50	
5 Test plugs	Black	DIA 2 mm 0.079 in	FC2.MC	1SNA107239R0300	20	1.00	
6 Assembly rods		2 poles		TGAB	1SNA168672R1100	10	1.00
		3 poles			1SNA168673R1200	10	
		4 poles			1SNA168674R1300	10	
		7 Spring retaining rings		ANT	1SNA168675R1400	10	
8 Terminal block markers	White	Blank card	RC610	1SNA233000R0100	1	7.50	

Complete list of accessories is indicated in the terminal block datasheet. Some accessories such as jumper bars may modify the terminal block's ratings: complete information in the accessories catalogue pages.

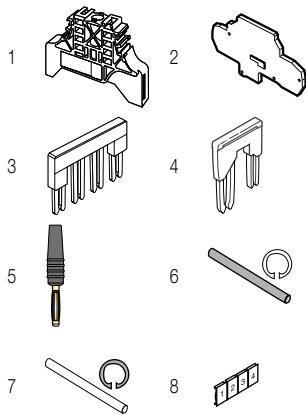

Fuse spring terminal blocks

Description	Color	Type	Order code	Pkg qty	Weight (1 pce) g
Fuse	Grey	D2.5/8.SFT.2L	1SNA290091R2600	50	14.00

All the technical data for UL/CSA standard and dimensions in inches are in italic. Technical data valid for copper conductors only.

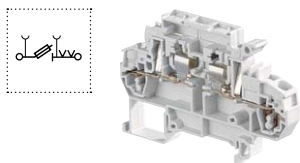

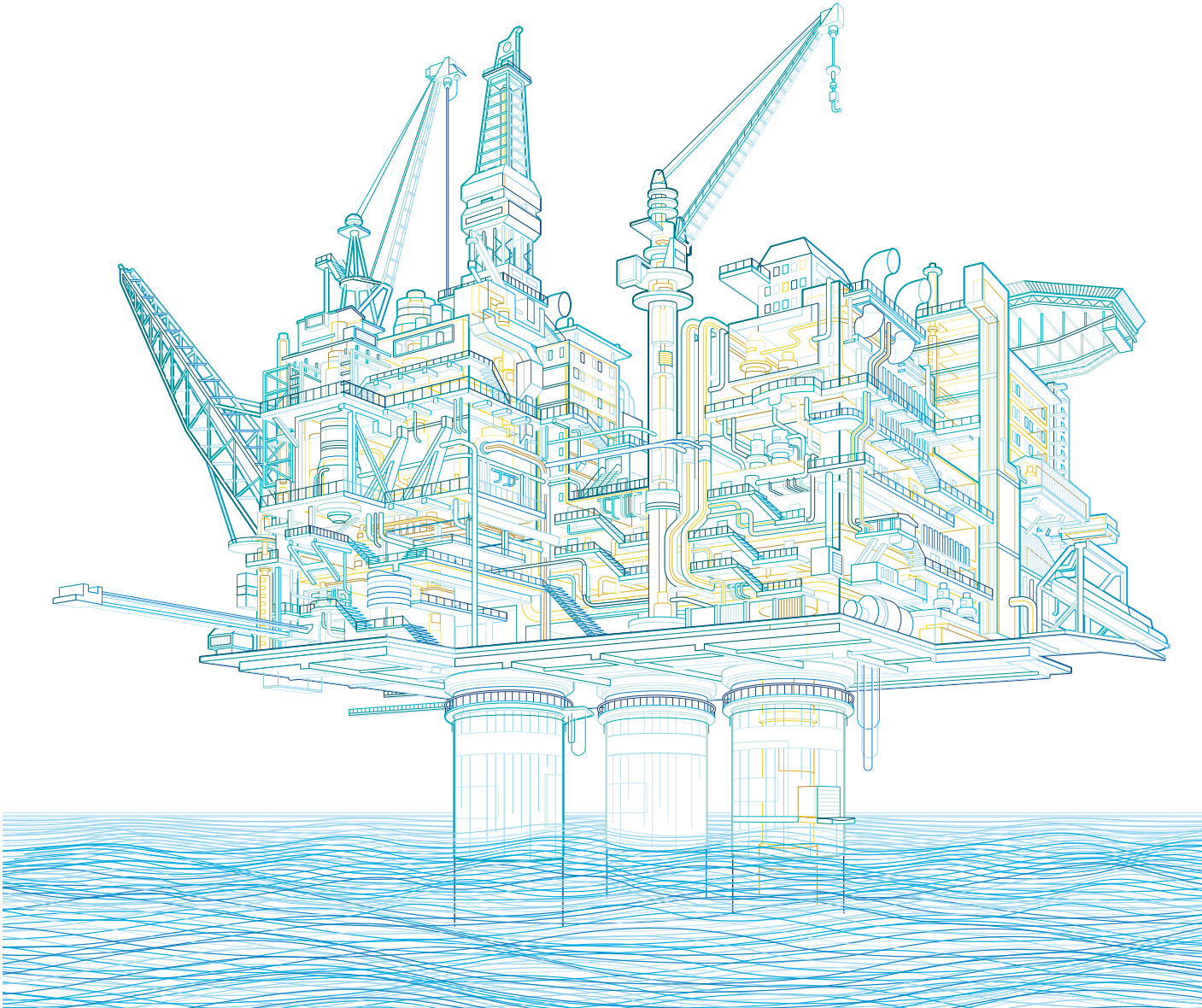

PB

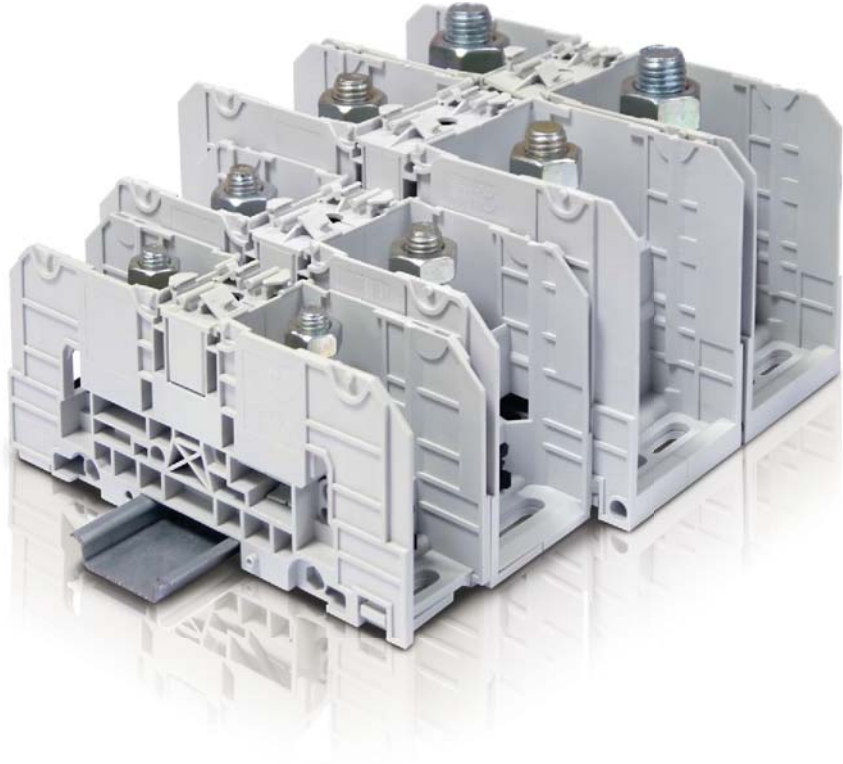

SNA series, terminal blocks

Stud technology

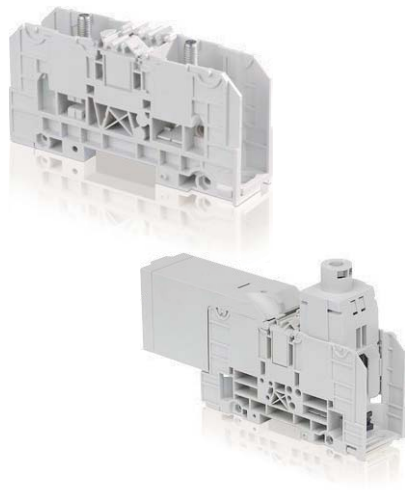

Overview 136

Feed-through stud

35 mm ² / 1 AWG	D35/27.FF	137
70 mm ² / 000 AWG	D70/32.FF	138
120 mm ² / 300 Kcmil	D120/42.FF	139
185 mm ² / 500 Kcmil	D185/55.FF	140
300 mm ² / 1000 Kcmil	D300/55.FF	141

Feed-through stud and screw clamp

35 mm ² / 1 AWG	D35/27.AF	142
70 mm ² / 000 AWG	D70/32.AF	143
120 mm ² / 300 AWG	D120/42.AF	144
185 mm ² / 500 AWG	D185/55.AF	145
Mounting instructions		146

SNA series, terminal blocks

Stud technology

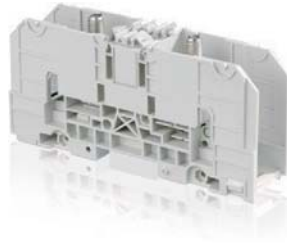

Feed-through

Section			○—v—○		○—v—○
IEC	UL/CSA				
35 mm ²	1 AWG	D35/27.FF	27 mm 1.063 in	D35/27.AF	27 mm 1.063 in
70 mm ²	000 AWG	D70/32.FF	32 mm 1.260 in	D70/32.AF	32 mm 1.260 in
120 mm ²	300 Kcmil	D120/42.FF	42 mm 1.654 in	D120/42.AF	42 mm 1.654 in
185 mm ²	500 Kcmil	D185/55.FF	55 mm 2.165 in	D185/55.AF	55 mm 2.165 in
300 mm ²	1000 Kcmil	D300/55.FF	55 mm 2.165 in		

○ Terminal - v Hole for testing or jumpering

D35/27.FF power terminal blocks

Feed-through - 27 mm 1.062 in spacing

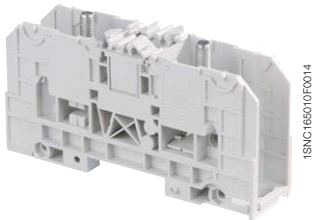

D35/27.FF

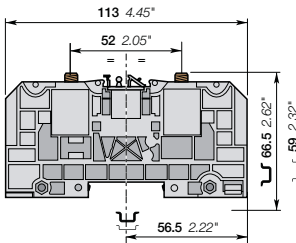

27 mm 1.062 in spacing

Description

- Rated cross section up to 300 mm² / 1000 Kcmil, IP20 protection cover,
- Holding foot on DIN 3 rail with two position for easy mounting, lug mounting in accordance with NF C 20-130 and DIN 46234, various marking options, rail or base mounting.

Ordering details

Description	Color	Type	Order code	Pkg qty	Weight (1 pce) g
Feed-through 2 studs M6 without cover	Grey <input type="checkbox"/>	D35/27.FF	1SNA190001R2000	10	130.00

Main technical data

Connecting capacity	NFC	DIN	UL	CSA
Lugs	Rigid - Solid / Stranded Flexible Gauge	2.5-35 mm ² 2.5-35 mm ² C4	2.5-50 mm ² 2.5-35 mm ²	1 AWG
Screw clamp	Rigid - Solid / Stranded Flexible Gauge		IEC	UL CSA
Bar			IEC	UL CSA
Rated current		125 A	125 A	
Rated cross section		35 mm ²	1 AWG	
Rated voltage		1000 V	600 V	
Impulse withstand voltage		8000 V		

Mounting instructions

Rail		TH 35-7.5, TH 35-15
Lugs		Wrench
Tool		H10 mm
Torque		3 - 6 N.m 26.1 - 52 lb.in
Jumper screw		Allen key
Tool		6 mm 0.236 in
Torque		6 - 12 N.m 52 - 104 lb.in
Screw clamp		
Tool		
Torque		
Wire stripping length		

The connecting capacity data for one Rigid - Solid / Stranded - Flexible conductor (when applicable) is a mandatory information required by IEC, UL and CSA standards. All other data are provided as supplementary information only. For more details, please consult our CB, UL or CSA certificates and technical datasheet available on <http://www.abb.com>

RoHS	UL	PC
RoHS	UL	Gost R

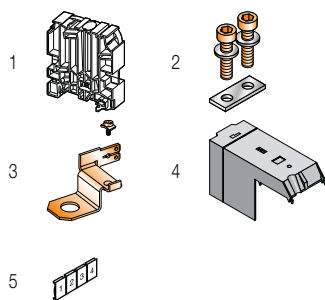

Accessories

Description	Color	Type	Order code	Pkg qty	Weight (1 pce) g
1 End stops 12 mm 0.472 in	Grey <input type="checkbox"/>	BADH	1SNA116900R2700	50	24.00
2 Jumper bars 2 poles		BJS27-2	1SNA205772R1300	5	34.00
3 poles		BJS27-3	1SNA205773R1400	5	52.00
3 Splitters For 6.35x0.8mm faston clips and screws		DRF6	1SNA205767R1600	10	4.00
4 Protecting covers IP20 rotating protecting cover	Grey <input type="checkbox"/>	CPUF35	1SNA190016R1600	10	8.30
5 Terminal block markers Blank card	White <input type="checkbox"/>	RC810	1SNA234000R0200	1	8.20

Complete list of accessories is indicated in the terminal block datasheet. Some accessories such as jumper bars may modify the terminal block's ratings: complete information in the accessories catalogue pages.

All the technical data for UL/CSA standard and dimensions in inches are in italic. Technical data valid for copper conductors only.

D70/32.FF power terminal blocks

Feed-through - 32 mm 1.260 in spacing

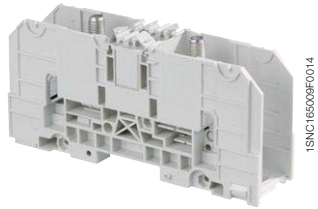

1SNC165009F0014

4

D70/32.FF

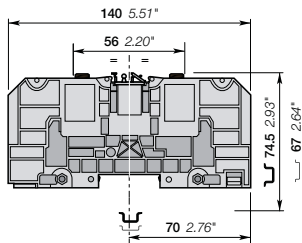

32 mm 1.260 in spacing

Description

- Rated cross section up to 300 mm² / 1000 Kcmil, IP20 protection cover,
- Holding foot on DIN 3 rail with two position for easy mounting, lug mounting in accordance with NF C 20-130 and DIN 46234, various marking options, rail or base mounting.

Ordering details

Description	Color	Type	Order code	Pkg qty	Weight (1 pce)
Feed-through 2 studs M8 without cover	Grey <input type="checkbox"/>	D70/32.FF	1SNA190002R2100	3	269.00

Main technical data

Connecting capacity		NFC	DIN	UL	CSA
Lugs	Rigid - Solid / Stranded	6-95 mm ²	6-70 mm ²	000 AWG	
	Flexible	6-70 mm ²	6-70 mm ²		
	Gauge	C6			
Screw clamp		IEC		UL	CSA
Screw clamp	Rigid - Solid / Stranded				
	Flexible				
	Gauge				
Bar		IEC		UL	CSA
Rated current		192 A		170 A	
Rated cross section		70 mm ²		000 AWG	
Rated voltage		1000 V		600 V	
Impulse withstand voltage		8000 V			

Mounting instructions

Rail		TH 35-7.5, TH 35-15
Lugs		Wrench H13 mm
Tool		
Torque		6 - 12 N.m 52 - 104 lb.in
Jumper screw		Allen key 6 mm 0.236 in
Tool		
Torque		6 - 12 N.m 52 - 104 lb.in
Screw clamp		
Tool		
Torque		
Wire stripping length		

The connecting capacity data for one Rigid - Solid / Stranded - Flexible conductor (when applicable) is a mandatory information required by IEC, UL and CSA standards. All other data are provided as supplementary information only. For more details, please consult our CB, UL or CSA certificates and technical datasheet available on <http://www.abb.com>

RoHS		USR CNR								
------	--	---------	--	--	--	--	--	--	--	--

Accessories

Description	Color	Type	Order code	Pkg qty	Weight (1 pce)
1 End stops 12 mm 0.472 in	Grey <input type="checkbox"/>	BADH	1SNA116900R2700	50	24.00
2 Jumper bars 2 poles		BJS32-2	1SNA205774R1500	5	66.00
3 poles		BJS32-3	1SNA205775R1600	5	105.80
3 Splitters For 6.35x0.8mm faston clips and screws		DRF8	1SNA205768R2700	10	5.00
4 Protecting covers IP20 rotating protecting cover	Grey <input type="checkbox"/>	CPUF70	1SNA190017R1700	10	12.00
5 Terminal block markers Blank card	White <input type="checkbox"/>	RC810	1SNA234000R0200	1	8.20

Complete list of accessories is indicated in the terminal block datasheet. Some accessories such as jumper bars may modify the terminal block's ratings: complete information in the accessories catalogue pages.

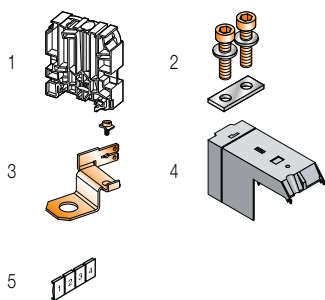

All the technical data for UL/CSA standard and dimensions in inches are in italic. Technical data valid for copper conductors only.

D120/42.FF power terminal blocks

Feed-through - 42 mm 1.653 in spacing

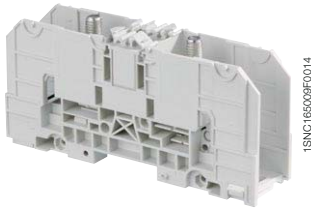

D120/42.FF

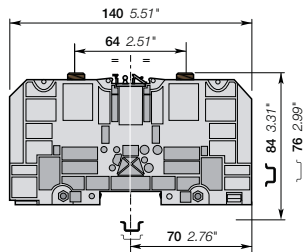

42 mm 1.653 in spacing

Description

- Rated cross section up to 300 mm² / 1000 Kcmil, IP20 protection cover,
- Holding foot on DIN 3 rail with two position for easy mounting, lug mounting in accordance with NF C 20-130 and DIN 46234, various marking options, rail or base mounting.

Ordering details

Description	Color	Type	Order code	Pkg qty	Weight (1 pce) g
Feed-through 2 studs M10 without cover	Grey <input type="checkbox"/>	D120/42.FF	1SNA190003R2200	1	423.00

Main technical data

Connecting capacity		NFC	DIN	UL	CSA
Lugs	Rigid - Solid / Stranded	6-150 mm ²	6-120 mm ²	300 Kcmil	
	Flexible	6-120 mm ²			
	Gauge	C8			
		IEC	UL	CSA	
Screw clamp	Rigid - Solid / Stranded				
	Flexible				
	Gauge				
		IEC	UL	CSA	
Bar					
Rated current		269 A		269 A	
Rated cross section		120 mm ²		300 Kcmil	
Rated voltage		1000 V		600 V	
Impulse withstand voltage		8000 V			

Mounting instructions

Rail		TH 35-7.5, TH 35-15
Lugs		Wrench
Tool		H17 mm
Torque		10 - 20 N.m 87 - 174 lb.in
Jumper screw		Allen key
Tool		6 mm 0.236 in
Torque		6 - 12 N.m 52 - 104 lb.in
Screw clamp		
Tool		
Torque		
Wire stripping length		

The connecting capacity data for one Rigid - Solid / Stranded - Flexible conductor (when applicable) is a mandatory information required by IEC, UL and CSA standards. All other data are provided as supplementary information only. For more details, please consult our CB, UL or CSA certificates and technical datasheet available on <http://www.abb.com>



Accessories

Description	Color	Type	Order code	Pkg qty	Weight (1 pce) g
1 End stops 12 mm 0.472 in	Grey <input type="checkbox"/>	BADH	1SNA116900R2700	50	24.00
2 Jumper bars		BJS42-2	1SNA205776R1700	5	93.00
		BJS42-3	1SNA205777R1000	5	153.00
3 Splitters For 6.35x0.8mm faston clips and screws		DRF10	1SNA205769R2000	10	7.00
4 Protecting covers IP20 rotating protecting cover	Grey <input type="checkbox"/>	CPUF120	1SNA190018R2000	5	24.00
5 Terminal block markers Blank card	White <input type="checkbox"/>	RC810	1SNA234000R0200	1	8.20

Complete list of accessories is indicated in the terminal block datasheet.

Some accessories such as jumper bars may modify the terminal block's ratings: complete information in the accessories catalogue pages.

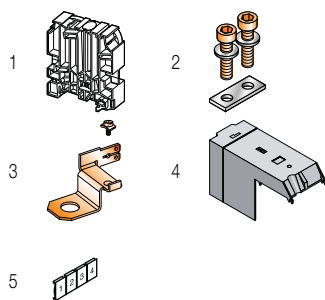

D185/55.FF power terminal blocks

Feed-through - 55 mm 2.165 in spacing



185 mm²
500 Kcmil

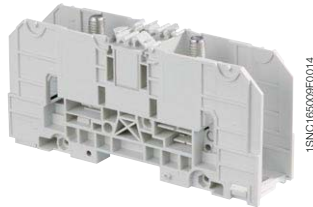

1SNC165009C014

4

D185/55.FF

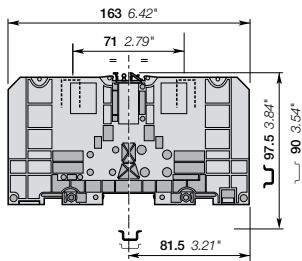

55 mm 2.165 in spacing

Description

- Rated cross section up to 300 mm² / 1000 Kcmil, IP20 protection cover,
- Holding foot on DIN 3 rail with two position for easy mounting, lug mounting in accordance with NF C 20-130 and DIN 46234, various marking options, rail or base mounting.

Ordering details

Description	Color	Type	Order code	Pkg qty	Weight (1 pce)
Feed-through 2 studs M12 without cover	Grey <input type="checkbox"/>	D185/55.FF	1SNA190004R2300	1	615.00

Main technical data

Connecting capacity		NFC	DIN	UL	CSA
Lugs	Rigid - Solid / Stranded	25-240 mm ²	6-185 mm ²	500 Kcmil	
	Flexible	6-185 mm ²			
	Gauge	C11			
		IEC	UL	CSA	
Screw clamp	Rigid - Solid / Stranded				
	Flexible				
	Gauge				
		IEC	UL	CSA	
Bar					
Rated current		353 A		353 A	
Rated cross section		185 mm ²		500 Kcmil	
Rated voltage		1000 V		600 V	
Impulse withstand voltage		8000 V			

Mounting instructions

Rail		TH 35-7.5, TH 35-15
Lugs		Wrench H24 mm
Tool		
Torque		25 - 50 N.m 217 - 435 lb.in
Jumper screw		Allen key 6 mm 0.236 in
Tool		
Torque		6 - 12 N.m 52 - 104 lb.in
Screw clamp		
Tool		
Torque		
Wire stripping length		

The connecting capacity data for one Rigid - Solid / Stranded - Flexible conductor (when applicable) is a mandatory information required by IEC, UL and CSA standards. All other data are provided as supplementary information only. For more details, please consult our CB, UL or CSA certificates and technical datasheet available on <http://www.abb.com>

RoHS		USR CNR																		
------	--	---------	--	--	--	--	--	--	--	--	--	--	--	--	--	--	--	--	--	--

Accessories

Description	Color	Type	Order code	Pkg qty	Weight (1 pce)
1 End stops 12 mm 0.472 in	Grey <input type="checkbox"/>	BADH	1SNA116900R2700	50	24.00
2 Jumper bars		BJS551-2	1SNA205778R2100	5	158.00
		BJS551-3	1SNA205779R2200	5	266.00
3 Splitters For 6.35x0.8mm faston clips and screws		DRF12	1SNA205770R2500	10	8.00
4 Protecting covers IP20 rotating protecting cover	Grey <input type="checkbox"/>	CPUF185	1SNA190019R2100	5	40.00
5 Terminal block markers Blank card	White <input type="checkbox"/>	RC810	1SNA234000R0200	1	8.20

Complete list of accessories is indicated in the terminal block datasheet.

Some accessories such as jumper bars may modify the terminal block's ratings: complete information in the accessories catalogue pages.

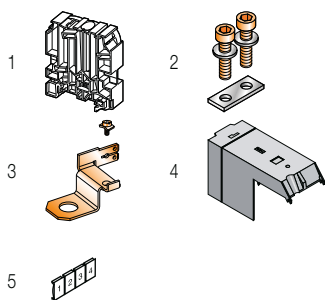

All the technical data for UL/CSA standard and dimensions in inches are in italic.
Technical data valid for copper conductors only.

D300/55.FF power terminal blocks

Feed-through - 55 mm 2.165 in spacing



D300/55.FF

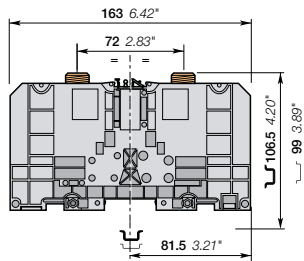

55 mm 2.165 in spacing

Description

- Rated cross section up to 300 mm² / 1000 Kcmil, IP20 protection cover,
- Holding foot on DIN 3 rail with two position for easy mounting, lug mounting in accordance with NF C 20-130 and DIN 46234, various marking options, rail or base mounting.

Ordering details

Description	Color	Type	Order code	Pkg qty	Weight (1 pce) g
Feed-through 2 studs M16 without cover	Grey <input type="checkbox"/>	D300/55.FF	1SNA190005R2400	1	775.00

Main technical data

Connecting capacity		NFC	DIN	UL	CSA
Lugs	Rigid - Solid / Stranded	25-300 mm ²	6-300 mm ²	1000 Kcmil	
	Flexible	6-300 mm ²			
	Gauge				
		IEC	UL	CSA	
Screw clamp	Rigid - Solid / Stranded				
	Flexible				
	Gauge				
		IEC	UL	CSA	
Bar					
Rated current		520 A		460 A	
Rated cross section		300 mm ²		1000 Kcmil	
Rated voltage		1000 V		600 V	
Impulse withstand voltage		8000 V			

Mounting instructions

Rail		TH 35-7.5, TH 35-15
Lugs		Wrench H24 mm
Tool		
Torque		25 - 50 N.m 217 - 435 lb.in
Jumper screw		Allen key 6 mm 0.236 in
Tool		
Torque		6 - 12 N.m 52 - 104 lb.in
Screw clamp		
Tool		
Torque		
Wire stripping length		

The connecting capacity data for one Rigid - Solid / Stranded - Flexible conductor (when applicable) is a mandatory information required by IEC, UL and CSA standards. All other data are provided as supplementary information only. For more details, please consult our CB, UL or CSA certificates and technical datasheet available on <http://www.abb.com>

RoHS	UL	Gost R			

Accessories

Description	Color	Type	Order code	Pkg qty	Weight (1 pce) g
1 End stops 12 mm 0.472 in	Grey <input type="checkbox"/>	BADH	1SNA116900R2700	50	24.00
2 Jumper bars		BJS551-2	1SNA205778R2100	5	158.00
		BJS551-3	1SNA205779R2200	5	266.00
3 Splitters For 6.35x0.8mm faston clips and screws		DRF16	1SNA205771R1200	10	7.00
4 Protecting covers IP20 rotating protecting cover	Grey <input type="checkbox"/>	CPUF185	1SNA190019R2100	5	40.00
5 Terminal block markers Blank card	White <input type="checkbox"/>	RC810	1SNA234000R0200	1	8.20

Complete list of accessories is indicated in the terminal block datasheet.

Some accessories such as jumper bars may modify the terminal block's ratings: complete information in the accessories catalogue pages.

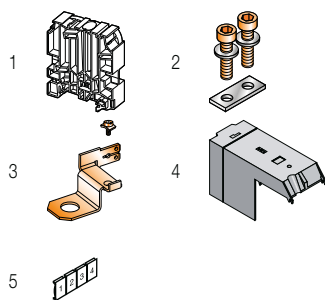

D70/32.AF power terminal blocks

Feed-through - 32 mm 1.260 in spacing

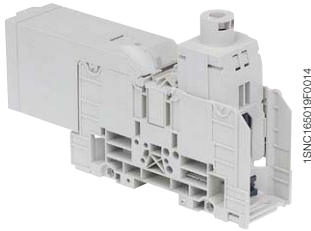

D70/32.AF

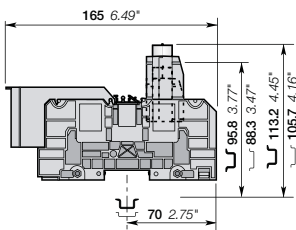

32 mm 1.260 in spacing

Description

- Rated cross section up to 240 mm² / 500 Kcmil, IP20 protection cover,
- Holding foot on DIN 3 rail with two position for easy mounting, lug mounting in accordance with NF C 20-130 and DIN 46234, various marking options, rail or base mounting.

Ordering details

Description	Color	Type	Order code	Pkg qty	Weight (1 pce)
Feed-through 1 stud M8 + 1 wire-clamp; with covers	Grey <input type="checkbox"/>	D70/32.AF	1SNA190007R2600	3	269.00 g

Main technical data

Connecting capacity		NFC	DIN	UL	CSA
Lugs	Rigid - Solid / Stranded	6-95 mm ²	6-70 mm ²	000 AWG	
	Flexible	6-70 mm ²	6-70 mm ²		
	Gauge				
		IEC	UL	CSA	
Screw clamp	Rigid - Solid / Stranded	6-95 mm ²		10-000 AWG	
	Flexible	6-70 mm ²			
	Gauge				
		IEC	UL	CSA	
Bar					
Rated current		192 A		165 A	
Rated cross section		70 mm ²		000 AWG	
Rated voltage		1000 V		600 V	
Impulse withstand voltage		8000 V			

Mounting instructions

Rail		TH 35-7.5, TH 35-15
Lugs		Wrench
Tool		H13 mm
Torque		6 - 12 N.m 52 - 104 lb.in
Jumper screw		Allen key
Tool		6 mm 0.236 in
Torque		6 - 12 N.m 52 - 104 lb.in
Screw clamp		Wrench
Tool		6 mm 0.236 in
Torque		6 - 12 N.m 52 - 104 lb.in
Wire stripping length		33 mm 1.299 in

The connecting capacity data for one Rigid - Solid / Stranded - Flexible conductor (when applicable) is a mandatory information required by IEC, UL and CSA standards. All other data are provided as supplementary information only. For more details, please consult our CB, UL or CSA certificates and technical datasheet available on <http://www.abb.com>



Accessories

Description	Color	Type	Order code	Pkg qty	Weight (1 pce)
1 End stops 12 mm 0.472 in	Grey <input type="checkbox"/>	BADH	1SNA116900R2700	50	24.00 g
2 Jumper bars		BJS32-2	1SNA205774R1500	5	66.00 g
		BJS32-3	1SNA205775R1600	5	105.80 g
3 Splitters For 6.35x0.8mm faston clips and screws		DRF8	1SNA205768R2700	10	5.00 g
4 Protecting covers IP20 rotating protecting cover	Grey <input type="checkbox"/>	CPUF70	1SNA190017R1700	10	12.00 g
5 Terminal block markers Blank card	White <input type="checkbox"/>	RC810	1SNA234000R0200	1	8.20 g

Complete list of accessories is indicated in the terminal block datasheet.

Some accessories such as jumper bars may modify the terminal block's ratings: complete information in the accessories catalogue pages.

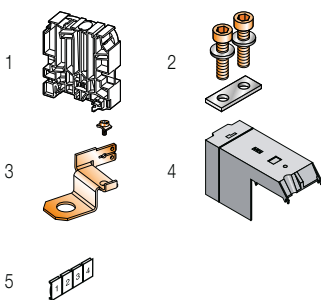

D120/42.AF power terminal blocks

Feed-through - 42 mm 1.653 in spacing

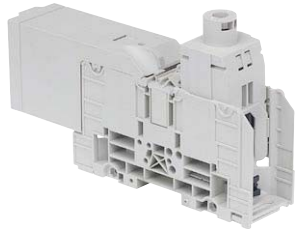

1SNC165019FD014

D120/42.AF

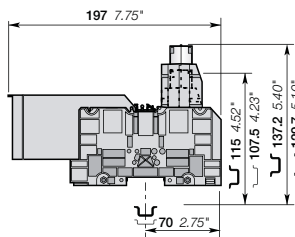

42 mm 1.653 in spacing

Description

- Rated cross section up to 240 mm² / 500 Kcmil, IP20 protection cover,
- Holding foot on DIN 3 rail with two position for easy mounting, lug mounting in accordance with NF C 20-130 and DIN 46234, various marking options, rail or base mounting.

Ordering details

Description	Color	Type	Order code	Pkg qty	Weight (1 pce)
Feed-through 1 stud M10 + 1 wire-clamp with covers	Grey <input type="checkbox"/>	D120/42.AF	1SNA190008R0700	1	423.00

Main technical data

Connecting capacity		NFC	DIN	UL	CSA
Lugs	Rigid - Solid / Stranded	6-150 mm ²	6-120 mm ²	300 Kcmil	
	Flexible	6-120 mm ²			
	Gauge	C8			
Screw clamp		IEC		UL	CSA
Screw clamp	Rigid - Solid / Stranded	6-150 mm ²		10 AWG-300 Kcmil	
	Flexible	6-120 mm ²			
	Gauge				
Bar		IEC		UL	CSA
Rated current		269 A		240 A	
Rated cross section		120 mm ²		300 Kcmil	
Rated voltage		1000 V		600 V	
Impulse withstand voltage		8000 V			

Mounting instructions

Rail		TH 35-7.5, TH 35-15
Lugs		Wrench
Tool		H17 mm
Torque		10 - 20 N.m 87 - 174 lb.in
Jumper screw		Allen key
Tool		6 mm 0.236 in
Torque		6 - 12 N.m 52 - 104 lb.in
Screw clamp		Allen key
Tool		8 mm 0.315 in
Torque		10 - 20 N.m 87 - 174 lb.in
Wire stripping length		38 mm 1.496 in

The connecting capacity data for one Rigid - Solid / Stranded - Flexible conductor (when applicable) is a mandatory information required by IEC, UL and CSA standards. All other data are provided as supplementary information only. For more details, please consult our CB, UL or CSA certificates and technical datasheet available on <http://www.abb.com>



Accessories

Description	Color	Type	Order code	Pkg qty	Weight (1 pce)
1 End stops 12 mm 0.472 in	Grey <input type="checkbox"/>	BADH	1SNA116900R2700	50	24.00
2 Jumper bars 2 poles		BJS42-2	1SNA205776R1700	5	93.00
3 poles		BJS42-3	1SNA205777R1000	5	153.00
3 Splitters For 6.35x0.8mm faston clips and screws		DRF10	1SNA205769R2000	10	7.00
4 Protecting covers IP20 rotating protecting cover	Grey <input type="checkbox"/>	CPUF120	1SNA190018R2000	5	24.00
5 Terminal block markers Blank card	White <input type="checkbox"/>	RC810	1SNA234000R0200	1	8.20

Complete list of accessories is indicated in the terminal block datasheet.

Some accessories such as jumper bars may modify the terminal block's ratings: complete information in the accessories catalogue pages.

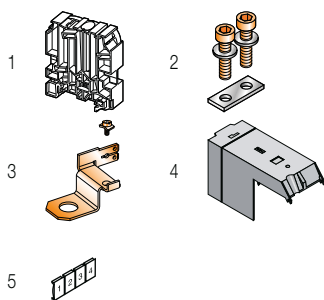

All the technical data for UL/CSA standard and dimensions in inches are in italic. Technical data valid for copper conductors only.

D185/55.AF power terminal blocks

Feed-through - 55 mm 2.165 in spacing

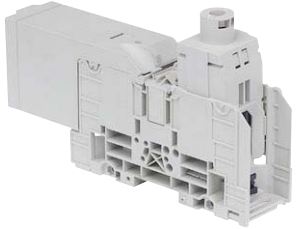

D185/55.AF

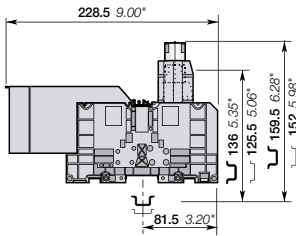

55 mm 2.165 in spacing

Description

- Rated cross section up to 240 mm² / 500 Kcmil, IP20 protection cover,
- Holding foot on DIN 3 rail with two position for easy mounting, lug mounting in accordance with NF C 20-130 and DIN 46234, various marking options, rail or base mounting.

Ordering details

Description	Color	Type	Order code	Pkg qty	Weight (1 pce) g
Feed-through 1 stud M12 + 1 wire-clamp with covers	Grey <input type="checkbox"/>	D185/55.AF	1SNA190009R0000	1	937.00

Main technical data

Connecting capacity		NFC	DIN	UL	CSA
Lugs	Rigid - Solid / Stranded	25-240 mm ²	6-185 mm ²	500 Kcmil	
	Flexible	6-185 mm ²			
	Gauge	C11			
		IEC	UL	CSA	
Screw clamp	Rigid - Solid / Stranded	25-240 mm ²		4 AWG-500 Kcmil	
	Flexible	25-185 mm ²			
	Gauge				
		IEC	UL	CSA	
Bar					
Rated current		353 A		320 A	
Rated cross section		185 mm ²		500 Kcmil	
Rated voltage		1000 V		600 V	
Impulse withstand voltage		8000 V			

Mounting instructions

Rail		TH 35-7.5, TH 35-15
Lugs		Wrench H24 mm
Tool		
Torque		25 - 50 N.m 217 - 435 lb.in
Jumper screw		Allen key 6 mm 0.236 in
Tool		
Torque		6 - 12 N.m 52 - 104 lb.in
Screw clamp		Allen key 10 mm 0.394 in
Tool		
Torque		14 - 20 N.m 121 - 174 lb.in
Wire stripping length		47 mm 1.850 in

The connecting capacity data for one Rigid - Solid / Stranded - Flexible conductor (when applicable) is a mandatory information required by IEC, UL and CSA standards. All other data are provided as supplementary information only. For more details, please consult our CB, UL or CSA certificates and technical datasheet available on <http://www.abb.com>



Accessories

Description	Color	Type	Order code	Pkg qty	Weight (1 pce) g
1 End stops 12 mm 0.472 in	Grey <input type="checkbox"/>	BADH	1SNA116900R2700	50	24.00
2 Jumper bars		BJS551-2	1SNA205778R2100	5	158.00
		BJS551-3	1SNA205779R2200	5	266.00
3 Splitters For 6.35x0.8mm faston clips and screws		DRF12	1SNA205770R2500	10	8.00
4 Protecting covers IP20 rotating protecting cover	Grey <input type="checkbox"/>	CPUF185	1SNA190019R2100	5	40.00
5 Terminal block markers Blank card	White <input type="checkbox"/>	RC810	1SNA234000R0200	1	8.20

Complete list of accessories is indicated in the terminal block datasheet.

Some accessories such as jumper bars may modify the terminal block's ratings: complete information in the accessories catalogue pages.

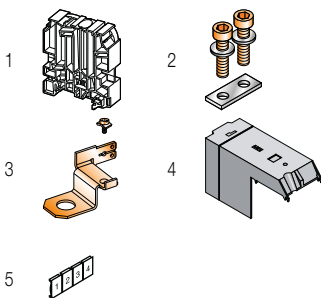

Power terminal blocks

Mounting instructions

Main dimensions mm

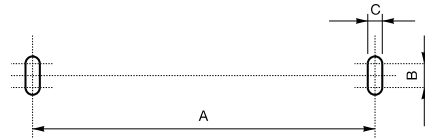
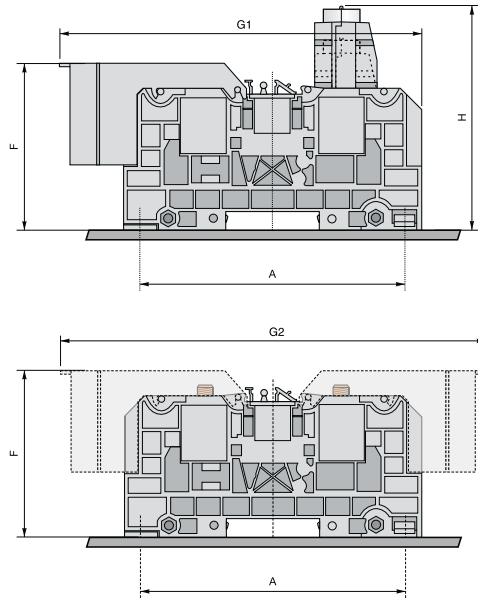

D35/27.AF - D70/32.AF - D120/42.AF
D35/27.FF - D70/32.FF - D120/42.FF

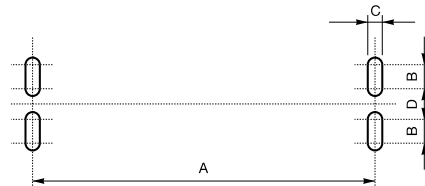

D185/55.AF
D185/55.FF - D300/55.FF

Type	Mounting with:	A	B	C	D	F	G1	G2	H
Dimensions mm									
D35/27...	2 Screws	100.5	7.5	6.5	/	63.5	136.5	160	82.5
D70/32...	2 Screws	120	7.5	6.5	/	72.5	165	190.5	105.7
D120/42...	2 Screws	120	7.5	6.5	/	83.5	197	255.5	129.7
D185/55...	4 Screws	135	13.5	6.5	8.5	103.5	228.5	295	151.5
D300/55...	4 Screws	135	13.5	6.5	8.5	105	/	295	/

Marking

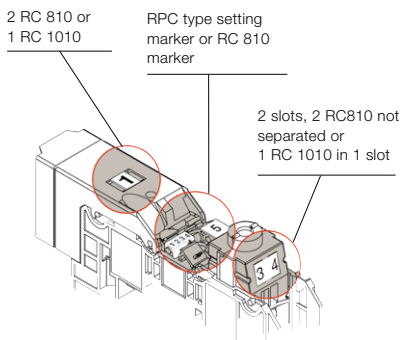

Jumper bar

- move the marker holders up
- cut out the partition
- screw the jumper bar

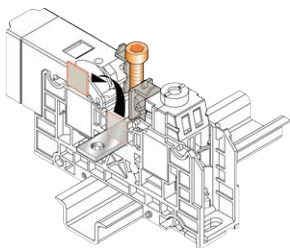

Locking foot operating with screwdriver DIA. 4 mm

Center opening (to be made after jumper bar has been removed) "monostable action".

As soon as the screwdriver is removed, the locking foot comes back to closed position

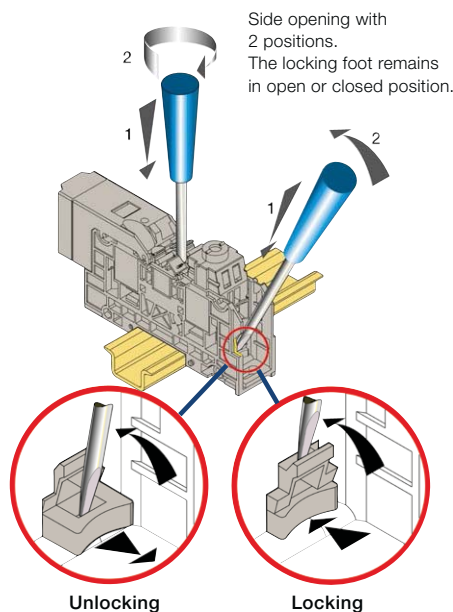

Locking

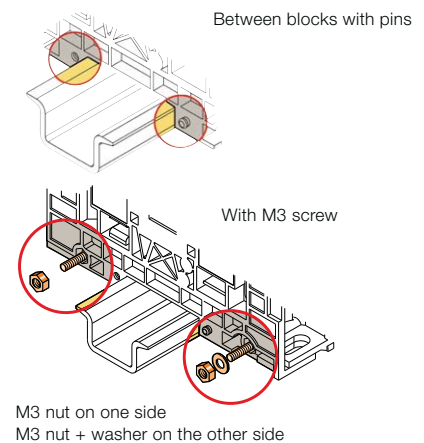

M3 nut on one side
M3 nut + washer on the other side

Mounting of the derivative system

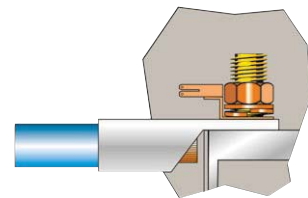

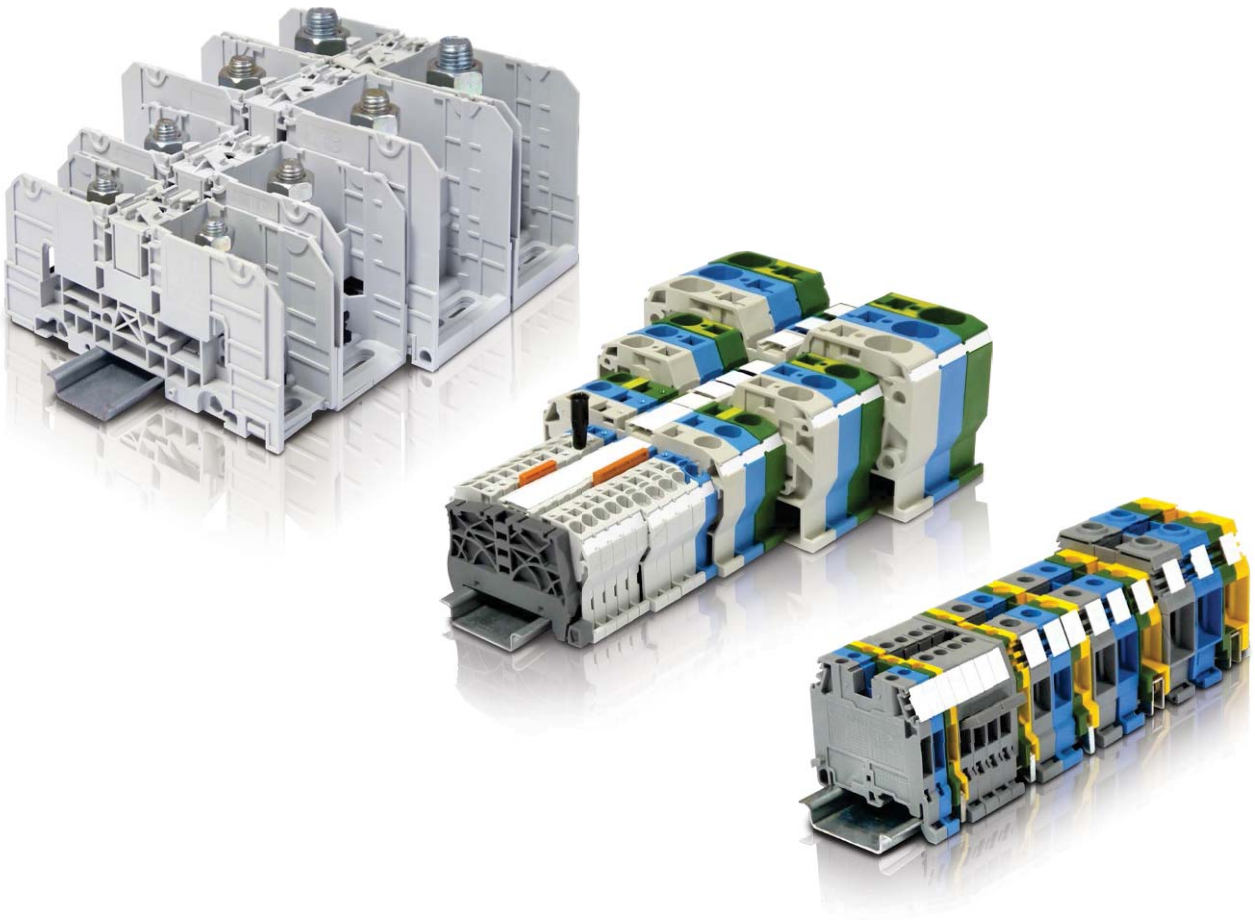

Index

Order code classification

Order code	Type	Page
1SNA007865R2600	FC2	15
1SNA008288R1500	FU520	76
1SNA008289R1600	FU520	76
1SNA008290R1300	FU520	76
1SNA008291R0000	FU520	76
1SNA008292R0100	FU520	76
1SNA103189R2600	SCD	54
1SNA103588R2600	SCFT1	67
1SNA105001R2700	M4/6	16
1SNA105002R2000	M4/6	16
1SNA105004R2200	M6/8	20
1SNA105003R1400	M4/6	16
1SNA105003R21500	M4/6	16
1SNA105044R2100	M4/6.D2	46
1SNA105045R2200	M4/6.D2	46
1SNA105046R2300	M4/6.D2	46
1SNA105047R2400	M4/6.D2	46
1SNA105048R0500	M4/6.D2	46
1SNA105049R0600	M4/6.D2	46
1SNA105051R2000	M4/6	16
1SNA105052R2100	MA2.5/5	14
1SNA105053R2200	M4/6.SNB	60
1SNA105055R2400	M6/8.SNB	62
1SNA105075R2000	MA2.5/5	14
1SNA105077R2200	MA2.5/5	14
1SNA105116R1600	M4/6	16
1SNA105118R2000	M6/8	20
1SNA105120R2600	M10/10	22
1SNA105124R1600	M35/16	25
1SNA105128R2200	M6/8.1	21
1SNA105129R2300	M16/12	24
1SNA105133R1700	BNF52	65
1SNA105135R1100	M4/8.SF2	77
1SNA105141R2700	M6/8.STP	68
1SNA105142R2000	M6/8.STP	68
1SNA105208R1300	M4/6.1	17
1SNA105209R1400	M4/6	16
1SNA105486R1200	MA2.5/5	14
1SNA107239R0300	FC2.MC	93
1SNA113003R1000	SCM6	16
1SNA113102R1000	SCF12	24
1SNA113137R0200	FEMT1	67
1SNA113373R2600	FEM8	62
1SNA113482R0500	SCM6D	46
1SNA113542R1000	PC5-2	14
1SNA113544R1200	PC5-10	14
1SNA113546R1400	PC6-2	16
1SNA113548R2600	PC6-10	16
1SNA113550R2400	EIP	14
1SNA113629R2700	FEMT2	71
1SNA114205R2000	AD2.5	55
1SNA114522R0500	SCFT2	71
1SNA114778R0500	FEMT4	70
1SNA114825R0500	SCFM6	14
1SNA114994R0700	FEM62	60
1SNA115116R0700	M4/6	16
1SNA115118R1100	M6/8	20
1SNA115120R1700	M10/10	22
1SNA115124R0700	M35/16	25
1SNA115126R0100	M4/6.D2.1	47
1SNA115129R1400	M16/12	24
1SNA115166R1100	M4/6.D1	49
1SNA115192R0400	M4/6.4	17
1SNA115204R2000	M4/6.D1.1	48
1SNA115217R1400	M4/6.2	17
1SNA115218R2500	M6/8.2	21
1SNA115219R2600	M6/8.4	21
1SNA115236R1700	M6/8.ST	71
1SNA115237R1000	M6/8.ST1	72
1SNA115239R2200	M6/8.ST3	73
1SNA115243R2600	M6/8.ST7	75
1SNA115259R0600	M4/6.1	17
1SNA115260R0300	M6/8.1	21
1SNA115261R2000	M10/10.1	23
1SNA115271R2200	M4/6.D2	46
1SNA115277R2000	M6/8.STP	68
1SNA115322R1500	M4/6.D2.2	47
1SNA115359R0200	M6/8.STA	70
1SNA115435R0700	M4/6.SB	64
1SNA115436R0000	M6/8.SB	65
1SNA115438R1200	M4/6.SNBT	61
1SNA115468R2000	M4/6.3A	18
1SNA115479R2300	M4/6.4A	19
1SNA115485R0200	MA2.5/5.1	15
1SNA115486R0300	MA2.5/5	14
1SNA115490R1300	MA2.5/5.D2	44
1SNA115491R0000	MA2.5/5.D2.1	45
1SNA115495R0400	M4/6.SNBT	61
1SNA115497R0600	M6/8.D2.1	51
1SNA115498R1700	M6/8.D1	51
1SNA115500R2500	M6/8.STP3	69
1SNA115501R1200	M6/8.D2	50

Order code	Type	Page
1SNA115505R1600	MA2.5/5.SNBTA	59
1SNA115523R0700	M4/8	81
1SNA115529R1500	M6/8.STP1	67
1SNA115530R1200	MA2.5/5.D1.1	45
1SNA115541R1100	D2.5/6.DA	53
1SNA115561R1500	M4/6.D2.SNBT	63
1SNA115604R2100	M4/8.D2.SF	82
1SNA115643R2700	D2.5/6.DPA1	52
1SNA115646R2200	M4/8.D2.SFL	83
1SNA115647R2300	M4/8.D2.SFD	83
1SNA115657R2500	M4/8.SF	76
1SNA115659R0700	M4/8.SN	80
1SNA115661R2100	M4/8.SFL	79
1SNA115662R2200	M4/8.SFT	77
1SNA115663R2300	M4/8.SFD	79
1SNA115665R2500	M4/8.SFDT	79
1SNA115667R2700	M4/8.SFLT	79
1SNA115668R0000	M4/8.SNT	80
1SNA115686R1300	MA2.5.SNB	60
1SNA115688R2500	M6/8.SNB	62
1SNA115699R2000	MA2.5/5.SNB	58
1SNA115700R0500	MA2.5/5.SNBT	59
1SNA115701R2200	MA2.5/5.SNBT	59
1SNA115702R2300	M4/6.D2.SBT	66
1SNA115935R0400	M4/8.SFD3	78
1SNA115936R0500	M4/8.D2.SFD3	83
1SNA115971R1000	M6/8.ST1.IP20	74
1SNA115986R0000	M4/6.SNB	60
1SNA115987R0100	M4/6.SNBT	61
1SNA116538R1700	PC8-2	20
1SNA116539R1000	PC8-3	62
1SNA116540R2500	PC8-4	62
1SNA116576R1500	FEM3A	18
1SNA116591R0500	FEMS6D	63
1SNA116629R2200	FEM4A	19
1SNA116656R2500	FEM8D1	50
1SNA116720R2100	SCMA5D	44
1SNA116728R2500	SCMA5	14
1SNA116771R2000	FED3E	52
1SNA116795R1100	SCFCV1-2	14
1SNA116797R1300	SCFCV4	26
1SNA116854R1400	BNSV62	66
1SNA116900R2700	BADH	26
1SNA116913R0700	FEM8D2S	82
1SNA116924R0200	BNF52	65
1SNA116926R0400	BNCT82	65
1SNA116927R0500	BNSV82	65
1SNA116951R1500	FEM8S	76
1SNA116979R2100	FEMSTA	14
1SNA118368R1600	FEM6	14
1SNA118495R1700	SCF6D	46
1SNA118499R2300	FEM12	44
1SNA118618R0100	FEM2D	24
1SNA118707R0300	SCF6	14
1SNA125116R0100	M4/6.N	16
1SNA125118R1300	M6/8.N	20
1SNA125120R1100	M10/10.N	22
1SNA125124R0100	M35/16.N	25
1SNA125126R0300	M4/6.D2.1.N	47
1SNA125129R1600	M16/12.N	24
1SNA125166R1300	M4/6.D1.N	49
1SNA125204R2200	M4/6.D1.1N	48
1SNA125260R0500	M6/8.1.N	21
1SNA125271R2400	M4/6.D2.1	46
1SNA125468R2200	M4/6.3A.N	18
1SNA125479R2500	M4/6.4A.N	19
1SNA125485R0400	MA2.5/5.1	15
1SNA125486R0500	MA2.5/5.N	14
1SNA125490R1500	MA2.5/5.D2.N	44
1SNA125505R1000	MA2.5/5.SNBTA	59
1SNA163043R2100	AL2	17
1SNA163046R2400	AL2	15
1SNA163070R0000	AL2	47
1SNA163261R0000	AL3	17
1SNA163311R2200	PC61-10	46
1SNA163313R2400	PC8-10	20
1SNA163315R2600	PC10-10	22
1SNA164581R1300	BJS8	69
1SNA164582R1400	BJS8	69
1SNA164583R1500	BJS8	69
1SNA164950R0000	AL2	45
1SNA165111R1400	M35/16.P	40
1SNA165113R1600	M4/6.P	32
1SNA165114R1700	M6/8.P	36
1SNA165115R1000	M10/10.P	38
1SNA165130R2300	M16/12.P	39
1SNA165488R2700	MA2.5/5.P	30
1SNA165809R1000	D4/6.P	33
1SNA165830R2100	D6/8.P	37
1SNA165909R0500	D2.5/5.P	31
1SNA167319R0600	AL2	54
1SNA167860R0100	FC4	17

Order code	Type	Page
1SNA167927R1000	FC4-1	67
1SNA168401R0300	EV8S	71
1SNA168520R0500	BJM8	84
1SNA168521R2200	BJM8	84
1SNA168522R2300	BJM8	84
1SNA168556R0500	FU633	86
1SNA168558R1700	FU633	86
1SNA168560R1500	FU633	86
1SNA168564R0500	TGA13	86
1SNA168565R0600	TGA13	86
1SNA168566R0700	TGA13	86
1SNA168672R1100	TGA8	76
1SNA168673R1200	TGA8	76
1SNA168674R1300	TGA8	76
1SNA168675R1400	ANT	76
1SNA168974R0000	BJM8	84
1SNA171018R2000	EXBN2	64
1SNA173217R2600	BJM62	54
1SNA173510R2000	PC13-10	86
1SNA173523R1100	PC81-10	76
1SNA173530R2400	CBM5D	44
1SNA173627R2100	EL6	14
1SNA173888R2000	BP8.A4	21
1SNA174789R0500	BJS8-20	69
1SNA176259R1300	ITV5	44
1SNA176278R1600	BJM5-2	14
1SNA176279R1700	BJM5-3	14
1SNA176280R0500	BJM5-4	14
1SNA176281R2200	BJM5-5	14
1SNA176282R2300	BJM5-10	14
1SNA176663R0000	BJM6-2	16
1SNA176664R0100	BJM6-3	16
1SNA176665R0200	BJM6-4	16
1SNA176666R0300	BJM6-5	16
1SNA176667R0400	BJM6-10	16
1SNA176669R1600	BJM8-2	20
1SNA176670R1300	BJM8-3	20
1SNA176671R0000	BJM8-4	20
1SNA176672R0100	BJM8-5	20
1SNA176673R0200	BJM8-10	20
1SNA176675R0400	BJM10-2	22
1SNA176676R0500	BJM10-3	22
1SNA176677R0600	BJM10-4	22
1SNA176678R1700	BJM10-5	22
1SNA176679R1000	BJM10-10	22
1SNA176736R2100	BJM5D-2	44
1SNA176737R2200	BJM5D-3	44
1SNA176738R0300	BJM5D-4	44
1SNA176739R0400	BJM5D-5	44
1SNA176740R1100	BJM5D-10	44
1SNA176791R2100	CPV4-5	26
1SNA176816R1200	CPV1-2	14
1SNA177812R1700	EL61	52
1SNA178024R2500	BJD6	52
1SNA178025R2600	BJD6	52
1SNA178026R2700	BJD6	52
1SNA178027R2000	BJD6	52
1SNA178032R2500	BJD6	52
1SNA178033R2600	BJD6	52
1SNA178408R1400	CB2D5	66
1SNA178745R1400	CBM5	14
1SNA179371R1600	CN5	76
1SNA179623R0300	BJDP1	16
1SNA179624R0400	BJDP2	24
1SNA179625R0500	BJDP3	16
1SNA179626R0600	BJM12-2	24
1SNA179628R1000	BJM12-3	24
1SNA179629R1100	BJM12-4	24
1SNA179630R1600	BJM12-5	24
1SNA179631R0300	BJM12-10	24
1SNA179668R2000	BJM6D-2	46
1SNA179669R2100	BJM6D-3	46
1SNA179670R2600	BJM6D-4	46
1SNA179671R1300	BJM6D-5	46
1SNA179672R1400	BJM6D-10	46
1SNA179726R0200	AJS9	71
1SNA187312R1400	CPM	14
1SNA190001R2000	D35/27.FF	137
1SNA190002R2100	D70/32.FF	138
1SNA190003R2200	D120/42.FF	139
1SNA190004R2300	D185/55.FF	140
1SNA190005R2400	D300/55.FF	141
1SNA190006R2500	D35/27.AF	142
1SNA190007R2600	D70/32.AF	143
1SNA190008R0700	D120/42.AF	144
1SNA190009R0000	D185/55.AF	145
1SNA190016R1600	CPUF35	137
1SNA190017R1700	CPUF70	138
1SNA190018R2000	CPUF120	139
1SNA190019R2100	CPUF185	140
1SNA195116R0000	M4/6	16
1SNA195118R1200	M6/8	20

Index

Order code classification

Order code	Type	Page	Order code	Type	Page	Order code	Type	Page
1SNA195120R1000	M10/10	22	1SNA290044R0600	D2.5/5.SNBT.2L	128	1SNA291696R2600	FED6.4L	100
1SNA195124R0000	M35/16	25	1SNA290061R0700	D4/6.2L	98	1SNA291711R2400	FED8.3L	102
1SNA195129R1500	M16/12	24	1SNA290062R0000	D4/6.2L	98	1SNA291713R2600	FED8.3L	102
1SNA195192R0500	M4/6.4	17	1SNA290063R0100	D4/6.N.2L	98	1SNA291721R2600	FED12.3L	106
1SNA195260R0400	M6/8.1	21	1SNA290064R0200	D4/6.2L	98	1SNA291731R2000	FED10.3L	104
1SNA195271R2300	M4/6.D2	46	1SNA290066R0400	D4/6.2L	98	1SNA291817R1700	FED5.T3.L	124
1SNA195438R1300	M4/6.SNBT	61	1SNA290067R0500	D4/6.2L	98	1SNA291818R2000	FED5.T3.PL	125
1SNA195486R0400	MA2.5/5	14	1SNA290069R1700	D4/6.P.2L	113	1SNA299486R2400	BFAUTO	64
1SNA195490R1400	MA2.5/5.D2	44	1SNA290081R2400	D6/8.2L	101	1SNA299683R0100	D4/6.T3	54
1SNA195501R1300	M6/8.D2	50	1SNA290082R2500	D6/8.2L	101	1SNA299684R0200	D4/6.T3.P	55
1SNA195637R1200	M4/6.3A.P	34	1SNA290083R2600	D6/8.N.2L	101	1SNA399067R0600	D2.5/5.I.N.3L	96
1SNA195638R2300	M4/6.4A.P	35	1SNA290084R2700	D6/8.2L	101	1SNA399068R1700	D2.5/5.I.3L	96
1SNA195686R1400	M4/6.SNB	60	1SNA290086R2100	D6/8.2L	101	1SNA399070R1500	D2.5/5.I.N.4L	97
1SNA196789R2400	BNSTP2	67	1SNA290087R2200	D6/8.2L	101	1SNA399071R0200	D2.5/5.I.4L	97
1SNA196792R1700	BNSTP1	67	1SNA290089R0400	D6/8.P.2L	116	1SNA399072R0300	D2.5/5.I.P.3L	111
1SNA196854R1500	BNSV62	64	1SNA290091R2600	D2.5/8.SFT.2L	130	1SNA399073R0400	D2.5/5.I.P.4L	112
1SNA196924R0300	BNF52	65	1SNA290092R2700	D2.5/8.SFT.2L	130	1SNA399260R2000	D2.5/5.I.3L	96
1SNA196926R0500	BNCT82	65	1SNA290093R2000	D2.5/8.SFLT.2L	131	1SNA399270R2200	D2.5/5.I.4L	97
1SNA196927R0600	BNSV82	65	1SNA290094R2100	D2.5/8.SFD.2L	131	1SNA399563R0400	BJDL12-2	105
1SNA196966R1500	BNF652-D1-BE	64	1SNA290097R2400	D2.5/8.SNT.2L	132	1SNA399571R0400	FED12.2L	105
1SNA196967R1600	BNF652L-BE	64	1SNA290131R2200	D2.5/5.SNBT.4L	129	1SNA399581R2700	D16/12.2L	105
1SNA196998R1600	BNF652	64	1SNA290132R2300	D2.5/5.SNBT.4L	129	1SNA399582R2000	D16/12.N.2L	105
1SNA196999R1700	BNF652D-BE	64	1SNA290134R2500	D2.5/5.SNBT.N.4L	129	1SNA399584R2200	D16/12.P.2L	120
1SNA199095R1300	ML10/13.SF	86	1SNA290161R0000	D2.5/5.D2.L	123	1SNA399613R0600	BJDPL6.12-2	98
1SNA199105R2200	ML10/13.SN	88	1SNA290163R0200	D2.5/5.D2.N.L	123	1SNA399617R0200	D35/16.2L	107
1SNA199166R2600	ML10/13.SFD	87	1SNA290301R1500	D10/10.1.2L	103	1SNA399618R1300	D35/16.N.2L	107
1SNA199168R0000	ML10/13.SFL	87	1SNA290302R1600	D10/10.1.2L	103	1SNA399620R1100	D35/16.P.2L	122
1SNA199219R0300	D4/6.T1	55	1SNA290303R1700	D10/10.1.N.2L	103	1SNA399621R0600	BJDL16-2	107
1SNA199220R0000	D4/6.PT1	56	1SNA290309R2500	D10/10.1.P.2L	118	1SNA399704R1200	D240/36.D10	29
1SNA199635R2400	FEM13U	86	1SNA290311R0600	FED5.1.3L	96	1SNA399706R1400	D240/36.D10.N	29
1SNA205767R1600	DRF6	137	1SNA290405R0600	D4/6.3L	99	1SNA399715R0400	D150/31.D10	28
1SNA205768R2700	DRF8	138	1SNA290406R0700	D4/6.3L	99	1SNA399717R0600	D150/31.D10.N	28
1SNA205769R2000	DRF10	139	1SNA290407R0000	D4/6.N.3L	99	1SNA399787R0500	CPBP2	29
1SNA205770R2500	DRF12	140	1SNA290409R1200	D4/6.P.3L	114	1SNA399788R1600	CPBP1	28
1SNA205771R1200	DRF16	141	1SNA290410R0600	D4/6.4L	100	1SNA399903R0200	BADL	14
1SNA205772R1300	BJS27-2	137	1SNA290411R2300	D4/6.4L	100	1SNA400146R0000	BNS6DG1	64
1SNA205773R1400	BJS27-3	137	1SNA290412R2400	D4/6.N.4L	100	1SNA400178R1000	D16/12.2L	105
1SNA205774R1500	BJS32-2	138	1SNA290414R2600	D4/6.P.4L	115	1SNA400179R1100	D16/12.2L	105
1SNA205775R1600	BJS32-3	138	1SNA290418R0200	D6/8.3L	102	1SNA400180R0700	D16/12.2L	105
1SNA205776R1700	BJS42-2	139	1SNA290419R0300	D6/8.N.3L	102	1SNA400181R2400	D35/16.2L	107
1SNA205777R1000	BJS42-3	139	1SNA290420R0000	D6/8.3L	102	1SNA400182R2200	D35/16.2L	107
1SNA205778R2100	BJS551-2	140	1SNA290422R2600	D6/8.P.3L	117	1SNA400183R2600	D35/16.2L	107
1SNA205779R2200	BJS551-3	140	1SNA290423R2700	D10/10.3L	104	1SNA400184R2700	MA2.5/5	14
1SNA206053R0700	BJM31.2	28	1SNA290424R2000	D10/10.N.3L	104	1SNA400186R2100	M6/8	20
1SNA206054R0000	BJM31.3	28	1SNA290425R2100	D10/10.3L	104	1SNA400187R2200	M6/8	20
1SNA206126R2500	BJM36.2	29	1SNA290427R2300	D10/10.P.3L	119	1SNA400188R0300	M10/10	22
1SNA206223R0600	BJM36.3	29	1SNA290428R0400	D16/12.3L	106	1SNA400189R0400	M10/10	22
1SNA206351R1600	BAM2	14	1SNA290429R0500	D16/12.N.3L	106	1SNA400190R0100	M10/10	22
1SNA206404R0500	M4/6	16	1SNA290430R0200	D16/12.3L	106	1SNA400191R2600	M16/12	24
1SNA206538R0200	M4/6.SNBT	61	1SNA290432R2000	D16/12.P.3L	121	1SNA400192R2700	M16/12	24
1SNA206659R2300	BADL	86	1SNA290456R0000	D2.5/5.T3.L	124	1SNA400193R2000	M16/12	24
1SNA206680R1500	AJS9-1	71	1SNA290457R0100	D2.5/5.T1.L	126	1SNA400194R2100	M35/16	25
1SNA206681R0200	AJS9-2	71	1SNA290458R1200	D2.5/5.T3.PL	125	1SNA400195R2200	M35/16	25
1SNA206682R0300	AJS9-3	71	1SNA290459R1300	D2.5/5.T1.PL	127	1SNA400196R2300	M35/16	25
1SNA206683R0400	AJS9-4	71	1SNA290464R0000	D2.5/5.2L	93	1SNA400219R1100	D2.5/5.I.3L	96
1SNA206720R1400	AJS9-5	71	1SNA290465R0100	D2.5/5.2L	93	1SNA400239R1500	M6/8	20
1SNA206721R0100	AL4-M3	17	1SNA291041R2000	FED5.4L	95	1SNA400270R2000	D4/8.D2.PSF	84
1SNA206723R0300	AL4-M4	25	1SNA291051R2200	FED5.3L	94	1SNA400271R1500	D4/8.D2.PSFL	85
1SNA231000R0700	RC510	14	1SNA291061R2400	FED5.2L	93	1SNA400272R1600	D4/8.D2.PSFD	85
1SNA232000R0000	RC65	52	1SNA291077R2400	CBDS.2L	93	1SNA400273R1700	FEM8D2S1	84
1SNA233000R0100	RC610	16	1SNA291102R2300	BJDL5-2	93	1SNA400305R1000	D70/22	26
1SNA234000R0200	RC810	20	1SNA291103R2400	BJDL5-3	93	1SNA400306R1100	D70/22.N	26
1SNA238000R1600	RC1010	22	1SNA291104R2500	BJDL5-4	93	1SNA400370R2400	D95/26	27
1SNA290011R2500	D2.5/5.4L	95	1SNA291105R2600	BJDL5-5	93	1SNA400371R1100	D95/26.N	27
1SNA290012R2600	D2.5/5.4L	95	1SNA291110R2600	BJDL5-10	93	1SNA400620R1700	D95/26.P	42
1SNA290013R2700	D2.5/5.N.4L	95	1SNA291122R1600	PCB8L-2	101	1SNA400711R0600	PC8-R1	71
1SNA290014R2000	D2.5/5.4L	95	1SNA291123R1700	BJDL8-3	101	1SNA400712R0700	PC8-R2	71
1SNA290015R2100	D2.5/5.4L	95	1SNA291128R2400	BJDL6-2	98	1SNA400713R0000	PC8-R3	71
1SNA290016R2200	D2.5/5.4L	95	1SNA291129R2500	BJDL6-3	98	1SNA400724R0300	PC8-R4	71
1SNA290017R2300	D2.5/5.4L	95	1SNA291131R1700	FED8SF.2L	130	1SNA400727R1300	D70/22.P	41
1SNA290018R0400	D2.5/5.4L	95	1SNA291144R2400	BJDL8-4	101	1SNA400778R0000	D150/31.D10.YL	28
1SNA290019R0500	D2.5/5.P.4L	110	1SNA291145R2500	BJDL8-5	101	1SNA400779R0000	D240/36.D10.YL	29
1SNA290021R2700	D2.5/5.2L	93	1SNA291150R0600	BJDPL5.6-2	93	1SNA400789R0000	D70/22.YL	26
1SNA290022R2000	D2.5/5.2L	93	1SNA291160R0000	BJDPL5.8-2	93	1SNA400791R0000	D95/26.YL	27
1SNA290023R2100	D2.5/5.N.2L	93	1SNA291161R2500	FED8.2L	101	1SNK900652R0000	SC-JB8-2	71
1SNA290024R2200	D2.5/5.2L	93	1SNA291170R0200	BJDPL6.8-2	98	1SNK900653R0000	SC-JB8-3	71
1SNA290025R2300	D2.5/5.2L	93	1SNA291194R1700	BJDL6-4	98	1SNK900654R0000	SC-JB8-4	71
1SNA290026R2400	D2.5/5.2L	93	1SNA291195R1000	BJDL6-5	98	1SNK916302R0000	JB16-2	25
1SNA290027R2500	D2.5/5.2L	93	1SNA291349R1100	ITVE.L	123	1SNK916303R0000	JB16-3	25
1SNA290028R0600	D2.5/5.2L	93	1SNA291352R0400	SCD5.2L	93	1SNK916304R0000	JB16-4	25
1SNA290029R0700	D2.5/5.P.2L	108	1SNA291362R0600	SCD5.3L	94	1SNK916305R0000	JB16-5	25
1SNA290031R2100	D2.5/5.3L	94	1SNA291372R0000	SCD5.4L	95	1SNK916310R0000	JB16-10	25
1SNA290032R2200	D2.5/5.3L	94	1SNA291441R2600	FED5.D.L	123	1SNK922302R0000	JB22-2	26
1SNA290033R2300	D2.5/5.N.3L	94	1SNA291461R2200	FED10.2L	103	1SNK922303R0000	JB22-3	26
1SNA290034R2400	D2.5/5.3L	94	1SNA291472R2500	BJDL1.10.2	103	1SNK922305R0000	JB22-5	26
1SNA290035R2500	D2.5/5.3L	94	1SNA291474R2700	BJDL1.10.3	103	1SNK922310R0000	JB22-10	26
1SNA290036R2600	D2.5/5.3L	94	1SNA291476R2100	BJDL1.10.4	103	1SNK926302R0000	JB26-2	27
1SNA290037R2700	D2.5/5.3L	94	1SNA291478R0300	BJDL1.10.5	103	1SNK926303R0000	JB26-3	27
1SNA290038R0000	D2.5/5.3L	94	1SNA291480R2200	BJDPL5.10-2	93	1SNK926305R0000	JB26-5	27
1SNA290039R0100	D2.5/5.P.3L	109	1SNA291482R1000	BJDPL6.10-2	98	1SNK926310R0000	JB26-10	27
1SNA290041R0300	D2.5/5.SNBT.2L	128	1SNA291484R1200	BJDPL8.10-2	101			
1SNA290042R0400	D2.5/5.SNBT.2L	128	1SNA291694R2400	FED6.3L	99			

Index

Type classification

Type	Order code	Page	Type	Order code	Page	Type	Order code	Page
AD2.5	1SNA114205R2000	55	BJM6D-3	1SNA179669R2100	46	D2.5/5.4L	1SNA290011R2500	95
AJS9	1SNA179726R0200	71	BJM6D-4	1SNA179670R2600	46		1SNA290012R2600	95
AJS9-1	1SNA206680R1500	71	BJM6D-5	1SNA179671R1300	46		1SNA290014R2000	95
AJS9-2	1SNA206681R0200	71	BJM8-10	1SNA176673R0200	20		1SNA290015R2100	95
AJS9-3	1SNA206682R0300	71	BJM8-2	1SNA176669R1600	20		1SNA290016R2200	95
AJS9-4	1SNA206683R0400	71	BJM8-3	1SNA176670R1300	20		1SNA290017R2300	95
AJS9-5	1SNA206720R1400	71	BJM8-4	1SNA176671R0000	20		1SNA290018R0400	95
AL2	1SNA163043R2100	17	BJM8-5	1SNA176672R0100	20	D2.5/5.D2.L	1SNA290161R0000	123
	1SNA163046R2400	15	BJS27-2	1SNA205772R1300	137	D2.5/5.D2.N.L	1SNA290163R0200	123
	1SNA163070R0000	47	BJS27-3	1SNA205773R1400	137	D2.5/5.1.3L	1SNA399068R1700	96
	1SNA164950R0000	45	BJS32-2	1SNA205774R1500	138		1SNA399260R2000	96
	1SNA167319R0600	54	BJS32-3	1SNA205775R1600	138		1SNA400219R1100	96
AL3	1SNA163261R0000	17	BJS42-2	1SNA205776R1700	139	D2.5/5.1.4L	1SNA399071R0200	97
AL4-M3	1SNA206721R0100	17	BJS42-3	1SNA205777R1000	139		1SNA399270R2200	97
AL4-M4	1SNA206723R0300	25	BJS551-2	1SNA205778R2100	140	D2.5/5.1.N.3L	1SNA399067R0600	96
ANT	1SNA168675R1400	76	BJS551-3	1SNA205779R2200	140	D2.5/5.1.N.4L	1SNA399070R1500	97
BADH	1SNA116900R2700	26	BJS8	1SNA164581R1300	69	D2.5/5.1.P.3L	1SNA399072R0300	111
BADL	1SNA206659R2300	86		1SNA164582R1400	69	D2.5/5.1.P.4L	1SNA399073R0400	112
	1SNA39903R0200	14	BJS8-20	1SNA164583R1500	69	D2.5/5.N.2L	1SNA290023R2100	93
BAM2	1SNA206351R1600	14	BNCT82	1SNA174789R0500	69	D2.5/5.N.3L	1SNA290033R2300	94
BFAUTO	1SNA299486R2400	64		1SNA116926R0400	65	D2.5/5.N.4L	1SNA290013R2700	95
BJD6	1SNA178024R2500	52	BNF52	1SNA196926R0500	65	D2.5/5.P	1SNA165909R0500	31
	1SNA178025R2600	52		1SNA105133R1700	65	D2.5/5.P.2L	1SNA290029R0700	108
	1SNA178026R2700	52		1SNA116924R0200	65	D2.5/5.P.3L	1SNA290039R0100	109
	1SNA178027R2000	52		1SNA196924R0300	65	D2.5/5.P.4L	1SNA290019R0500	110
	1SNA178032R2500	52	BNF652	1SNA196998R1600	64	D2.5/5.SNBT.2L	1SNA290041R0300	128
	1SNA178033R2600	52	BNF652-D1-BE	1SNA196966R1500	64		1SNA290042R0400	128
	1SNA178034R2700	52	BNF652D-BE	1SNA196999R1700	64		1SNA290044R0600	128
BJDL1.10.2	1SNA291472R2500	103	BNF652L-BE	1SNA196967R1600	64	D2.5/5.SNBT.4L	1SNA290131R2200	129
BJDL1.10.3	1SNA291474R2700	103	BNS6DG1	1SNA400146R0000	64		1SNA290132R2300	129
BJDL1.10.4	1SNA291476R2100	103	BNSSTP1	1SNA196792R1700	67	D2.5/5.SNBT.N.4L	1SNA290134R2500	129
BJDL1.10.5	1SNA291478R0300	103	BNSTP2	1SNA196789R2400	67	D2.5/5.T1.L	1SNA290045R0100	126
BJDL12-2	1SNA399563R0400	105	BNSV62	1SNA116854R1400	66	D2.5/5.T1.PL	1SNA290459R1300	127
BJDL16-2	1SNA399621R0600	107		1SNA196854R1500	64	D2.5/5.T3.L	1SNA290456R0000	124
BJDL5-10	1SNA291110R2600	93	BNSV82	1SNA116927R0500	65	D2.5/5.T3.PL	1SNA290458R1200	125
BJDL5-2	1SNA291102R2300	93		1SNA196927R0600	65	D2.5/5.6.DA	1SNA115541R1100	53
BJDL5-3	1SNA291103R2400	93	BP8.A4	1SNA173888R2000	21	D2.5/6.DPA1	1SNA115643R2700	52
BJDL5-4	1SNA291104R2500	93	CBD2S	1SNA178408R1400	66	D2.5/8.SFDT.2L	1SNA290094R2100	131
BJDL5-5	1SNA291105R2600	93	CBD5.2L	1SNA291077R2400	93	D2.5/8.SFLT.2L	1SNA290093R2000	131
BJDL6-2	1SNA291128R2400	98	CBM5	1SNA178745R1400	14	D2.5/8.SFT.2L	1SNA290091R2600	130
BJDL6-3	1SNA291129R2500	98	CBM5D	1SNA173530R2400	44		1SNA290092R2700	130
BJDL6-4	1SNA291194R1700	98	CN5	1SNA179371R1600	76	D2.5/8.SNT.2L	1SNA290097R2400	132
BJDL6-5	1SNA291195R1000	98	CPBP1	1SNA399788R1600	28	D240/36.D10	1SNA399704R1200	29
BJDL8-2	1SNA291122R1600	101	CPBP2	1SNA399787R0500	29	D240/36.D10.N	1SNA399706R1400	29
BJDL8-3	1SNA291123R1700	101	CPM	1SNA187312R1400	14	D240/36.D10.YL	1SNA400779R0000	29
BJDL8-4	1SNA291144R2400	101	CPUF120	1SNA190018R2000	139	D300/55.FF	1SNA190005R2400	141
BJDL8-5	1SNA291145R2500	101	CPUF185	1SNA190019R2100	140	D35/16.2L	1SNA399617R0200	107
BJDP1	1SNA179623R0300	16	CPUF35	1SNA190016R1600	137		1SNA400181R2400	107
BJDP2	1SNA179624R0400	24	CPUF70	1SNA190017R1700	138		1SNA400182R2200	107
BJDP3	1SNA179625R0500	16	CPV1-2	1SNA176816R1200	14		1SNA400183R2600	107
BJDPL5.10-2	1SNA291480R2200	93	CPV4-5	1SNA176791R2100	26	D35/16.N.2L	1SNA399618R1300	107
BJDPL5.6-2	1SNA291150R0600	93	D10/10.1.2L	1SNA290301R1500	103	D35/16.P.2L	1SNA399620R100	122
BJDPL5.8-2	1SNA291160R0000	93		1SNA290302R1600	103	D35/27.AF	1SNA190006R2500	142
BJDPL6.10-2	1SNA291482R1000	98	D10/10.1.N.2L	1SNA290303R1700	103	D35/27.FF	1SNA190001R2000	137
BJDPL6.12-2	1SNA399613R0600	98	D10/10.1.P.2L	1SNA290309R2500	118	D4/6.2L	1SNA290061R0700	98
BJDPL6.8-2	1SNA291170R0200	98	D10/10.3L	1SNA290423R2700	104		1SNA290062R0000	98
BJDPL8.10-2	1SNA291484R1200	101		1SNA290425R2100	104		1SNA290064R0200	98
BJM62	1SNA173217R2600	54	D10/10.N.3L	1SNA290424R2000	104		1SNA290066R0400	98
BJM8	1SNA168520R0500	84	D10/10.P.3L	1SNA290427R2300	119		1SNA290067R0500	98
	1SNA168521R2200	84	D120/42.AF	1SNA190008R0700	144	D4/6.3L	1SNA290405R0600	99
	1SNA168522R2300	84	D120/42.FF	1SNA190003R2200	139		1SNA290406R0700	99
	1SNA168974R0000	84	D150/31.D10	1SNA399715R0400	28	D4/6.4L	1SNA290410R0600	100
BJMI10-10	1SNA176679R1000	22	D150/31.D10.N	1SNA399717R0600	28		1SNA290411R2300	100
BJMI10-2	1SNA176675R0400	22	D150/31.D10.YL	1SNA400778R0000	28	D4/6.N.2L	1SNA290063R0100	98
BJMI10-3	1SNA176676R0500	22	D16/12.2L	1SNA399581R2700	105	D4/6.N.3L	1SNA290407R0000	99
BJMI10-4	1SNA176677R0600	22		1SNA400178R1000	105	D4/6.N.4L	1SNA290412R2400	100
BJMI10-5	1SNA176678R1700	22	D16/12.3L	1SNA290428R0400	106	D4/6.P	1SNA165809R0100	33
BJMI12-10	1SNA179631R0300	24		1SNA290430R0200	106	D4/6.P.2L	1SNA290069R1700	113
BJMI12-2	1SNA179626R0600	24	D16/12.N.2L	1SNA399582R2000	105	D4/6.P.3L	1SNA290409R1200	114
BJMI12-3	1SNA179628R1000	24	D16/12.N.3L	1SNA290429R0500	106	D4/6.P.4L	1SNA290414R2600	115
BJMI12-4	1SNA179629R1100	24	D16/12.P.2L	1SNA399584R2200	120	D4/6.P.T1	1SNA199220R0000	56
BJMI12-5	1SNA179630R1600	24	D16/12.P.3L	1SNA290432R2000	121	D4/6.T1	1SNA199219R0300	55
BJMI31.2	1SNA206053R0700	28	D16/12.P.4L	1SNA290434R2000	121	D4/6.T3	1SNA299683R0100	54
BJMI31.3	1SNA206054R0000	28	D185/55.AF	1SNA190009R0000	145	D4/6.T3.P	1SNA299684R0200	55
BJMI36.2	1SNA206126R2500	29	D185/55.FF	1SNA190004R2300	140	D4/8.D2.PSF	1SNA400270R2000	84
BJMI36.3	1SNA206223R0600	29	D2.5/5.2L	1SNA290021R2700	93	D4/8.D2.PSFD	1SNA400272R1600	85
BJMI5-10	1SNA176282R2300	14		1SNA290022R2000	93	D4/8.D2.PSFL	1SNA400271R1500	85
BJMI5-2	1SNA176278R1600	14		1SNA290024R2200	93	D6/8.2L	1SNA290081R2400	101
BJMI5-3	1SNA176279R1700	14		1SNA290025R2300	93		1SNA290082R2500	101
BJMI5-4	1SNA176280R0500	14		1SNA290026R2400	93		1SNA290084R2700	101
BJMI5-5	1SNA176281R2200	14		1SNA290027R2500	93		1SNA290086R2100	101
BJMI5D-10	1SNA176740R1100	44		1SNA290028R0600	93	D6/8.3L	1SNA290418R0200	101
BJMI5D-2	1SNA176736R2100	44		1SNA290464R0000	93		1SNA290420R0000	102
BJMI5D-3	1SNA176737R2200	44		1SNA290465R0100	93	D6/8.N.2L	1SNA290083R2600	101
BJMI5D-4	1SNA176738R0300	44	D2.5/5.3L	1SNA290031R2100	94	D6/8.N.3L	1SNA290419R0300	102
BJMI5D-5	1SNA176739R0400	44		1SNA290032R2200	94	D6/8.P	1SNA165803R2100	37
BJMI6-10	1SNA176667R0400	16		1SNA290034R2400	94	D6/8.P.2L	1SNA290089R0400	116
BJMI6-2	1SNA176663R0000	16		1SNA290035R2500	94	D6/8.P.3L	1SNA290422R2600	117
BJMI6-3	1SNA176664R0100	16		1SNA290036R2600	94	D70/22	1SNA400305R1100	26
BJMI6-4	1SNA176665R0200	16		1SNA290037R2700	94	D70/22.N	1SNA400306R100	26
BJMI6-5	1SNA176666R0300	16		1SNA290038R0000	94	D70/22.P	1SNA400772R1300	41
BJMI6D-10	1SNA179672R1400	46						
BJMI6D-2	1SNA179668R2000	46						

Index

Type classification

Type	Order code	Page	Type	Order code	Page	Type	Order code	Page
D70/22.YL	1SNA400789R0000	26		1SNA400192R2700	24	M6/8.D2	1SNA115501R1200	50
D70/32.AF	1SNA190007R2600	143		1SNA400193R2000	24		1SNA195501R1300	50
D70/32.FF	1SNA190002R2100	138	M16/12.N	1SNA125129R1600	24	M6/8.D2.1	1SNA115497R0600	51
D95/26	1SNA400370R2400	27	M16/12.P	1SNA165130R2300	39	M6/8.N	1SNA125118R1300	20
D95/26.N	1SNA400371R1100	27	M35/16	1SNA105124R1600	25	M6/8.P	1SNA165114R1700	36
D95/26.P	1SNA400620R1700	42		1SNA115124R0700	25	M6/8.SB	1SNA115436R0000	65
D95/26.YL	1SNA400791R0000	27		1SNA195124R0000	25	M6/8.SNB	1SNA105055R2400	62
DRF10	1SNA205769R2000	139		1SNA400194R2100	25		1SNA115688R2500	62
DRF12	1SNA205770R2500	140		1SNA400195R2200	25	M6/8.ST	1SNA115236R1700	71
DRF16	1SNA205771R1200	141		1SNA400196R2300	25	M6/8.ST1	1SNA115237R1000	72
DRF6	1SNA205767R1600	137	M35/16.N	1SNA125124R0100	25	M6/8.ST1.IP20	1SNA115971R1000	74
DRF8	1SNA205768R2700	138	M35/16.P	1SNA165111R1400	40	M6/8.ST3	1SNA115239R2200	73
EIP	1SNA113550R2400	14	M4/6	1SNA105001R2700	16	M6/8.ST7	1SNA115243R2600	75
EL6	1SNA173627R2100	14		1SNA105002R2000	16	M6/8.STA	1SNA115359R0200	70
EL61	1SNA177812R1700	52		1SNA105031R1400	16	M6/8.STP	1SNA105141R2700	68
EV8S	1SNA168401R0300	71		1SNA105032R1500	16		1SNA105142R2000	68
EXBN2	1SNA171018R2000	64		1SNA105051R2000	16		1SNA115277R2000	68
FC2	1SNA007865R2600	15		1SNA105116R1600	16	M6/8.STP1	1SNA115529R1500	67
FC2.MC	1SNA107239R0300	93		1SNA105209R1400	16	M6/8.STP3	1SNA115500R2500	69
FC4	1SNA167860R0100	17		1SNA115116R0700	16	MA2.5/5	1SNA105052R2100	14
FC4-1	1SNA167927R1000	67		1SNA195116R0000	16		1SNA105075R2000	14
FED10.2L	1SNA291461R2200	103		1SNA206404R0500	16		1SNA105077R2200	14
FED10.3L	1SNA291731R2000	104	M4/6.1	1SNA105208R1300	17		1SNA105486R1200	14
FED12.2L	1SNA399571R0400	105		1SNA115259R0600	17		1SNA115486R0300	14
FED12.3L	1SNA291721R2600	106	M4/6.2	1SNA115217R1400	17		1SNA195486R0400	14
FED3E	1SNA116771R2000	52	M4/6.3A	1SNA115468R2000	18		1SNA400184R2700	14
FED5.2L	1SNA291061R2400	93	M4/6.3A.N	1SNA125468R2200	18	MA2.5/5.1	1SNA115485R0200	15
FED5.3L	1SNA291051R2200	94	M4/6.3A.P	1SNA195637R1200	34		1SNA125485R0400	15
FED5.4L	1SNA291041R2000	95	M4/6.4	1SNA115192R0400	17	MA2.5/5.D1.1	1SNA115530R1200	45
FED5.D.L	1SNA291441R2600	123		1SNA195192R0500	17	MA2.5/5.D2	1SNA115490R1300	44
FED5.I.3L	1SNA290311R0600	96	M4/6.4A	1SNA115479R2300	19		1SNA195490R1400	44
FED5.T3.L	1SNA291817R1700	124	M4/6.4A.N	1SNA125479R2500	19	MA2.5/5.D2.1	1SNA115491R0000	45
FED5.T3.PL	1SNA291818R2000	125	M4/6.4A.P	1SNA195638R2300	35	MA2.5/5.D2.N	1SNA125490R1500	44
FED6.3L	1SNA291694R2400	99	M4/6.D1	1SNA115166R1100	49	MA2.5/5.N	1SNA125486R0500	14
FED6.4L	1SNA291696R2600	100	M4/6.D1.1	1SNA115204R2000	48	MA2.5/5.P	1SNA1165488R2700	30
FED8.2L	1SNA291161R2500	101	M4/6.D1.1N	1SNA125204R2200	48	MA2.5/5.SNB	1SNA115699R2000	58
FED8.3L	1SNA291711R2400	102	M4/6.D1.N	1SNA125166R1300	49	MA2.5/5.SNBT	1SNA115700R0500	59
	1SNA291713R2600	102	M4/6.D2	1SNA105044R2100	46		1SNA115701R2200	59
FED8SF.2L	1SNA291131R1700	130		1SNA105045R2200	46	MA2.5/5.SNBTA	1SNA115505R1600	59
FEM12	1SNA118618R0100	24		1SNA105046R2300	46		1SNA125505R1000	59
FEM13U	1SNA199635R2400	86		1SNA105047R2400	46	ML10/13.SF	1SNA199095R1300	86
FEM3A	1SNA116576R1500	18		1SNA105048R0500	46	ML10/13.SFD	1SNA199166R2600	87
FEM4A	1SNA116629R2200	19		1SNA105049R0600	46	ML10/13.SFL	1SNA199168R0000	87
FEM6	1SNA118368R1600	14		1SNA115271R2200	46	ML10/13.SN	1SNA199105R2200	88
FEM62	1SNA114994R0700	60		1SNA195271R2300	46	PC10-10	1SNA163315R2600	22
FEM6D	1SNA118499R2300	44	M4/6.D2.1	1SNA115126R0100	47	PC13-10	1SNA173510R2000	86
FEM8	1SNA113373R2600	62	M4/6.D2.1.N	1SNA125126R0300	47	PC5-10	1SNA113544R1200	14
FEM8D1	1SNA116656R2500	50	M4/6.D2.2	1SNA115322R1500	47	PC5-2	1SNA113542R1000	14
FEM8D2S	1SNA116913R0700	82	M4/6.D2.N	1SNA125271R2400	46	PC6-10	1SNA113548R2600	16
FEM8D2S1	1SNA400273R1700	84	M4/6.D2.SBT	1SNA115702R2300	66	PC61-10	1SNA163311R2200	46
FEM8S	1SNA116951R1500	76	M4/6.D2.SNBT	1SNA115561R1500	63	PC6-2	1SNA113546R1400	16
FEMS6D	1SNA116591R0500	63	M4/6.N	1SNA125116R0100	16	PC8-10	1SNA163313R2400	20
FEMSTA	1SNA116979R2100	70	M4/6.P	1SNA165113R1600	32	PC81-10	1SNA173523R1100	76
FEMT1	1SNA113137R0200	67	M4/6.SB	1SNA115435R0700	64	PC8-2	1SNA116538R1700	20
FEMT2	1SNA113629R2700	71	M4/6.SNB	1SNA105053R2200	60	PC8-3	1SNA116539R1000	62
FEMT4	1SNA114778R0500	70		1SNA115686R1300	60	PC8-4	1SNA116540R2500	62
FU520	1SNA008288R1500	76		1SNA115986R0000	60	PC8-R1	1SNA400711R0600	71
	1SNA008289R1600	76		1SNA195686R1400	60	PC8-R2	1SNA400712R0700	71
	1SNA008290R1300	76	M4/6.SNBT	1SNA115438R1200	61	PC8-R3	1SNA400713R0000	71
	1SNA008291R0000	76		1SNA115495R0400	61	PC8-R4	1SNA400724R0300	71
	1SNA008292R0100	76		1SNA115987R0100	61	RC1010	1SNA238000R1600	22
FU633	1SNA168556R0500	86		1SNA195438R1300	61	RC510	1SNA231000R0700	14
	1SNA168558R1700	86	M4/8	1SNA206538R0200	61	RC610	1SNA233000R0100	16
	1SNA168560R1500	86		1SNA115523R0700	81	RC65	1SNA232000R0000	52
ITV5	1SNA176259R1300	44	M4/8.D2.SF	1SNA115604R2100	82	RC810	1SNA234000R0200	20
ITVE.L	1SNA291349R1100	123	M4/8.D2.SFD	1SNA115647R2300	83	SCD	1SNA103189R2600	54
JB16-10	1SNK916310R0000	25	M4/8.D2.SFD3	1SNA115936R0500	83	SCD5.2L	1SNA291352R0400	93
JB16-2	1SNK916302R0000	25	M4/8.D2.SFL	1SNA115646R2200	83	SCD5.3L	1SNA291362R0600	94
JB16-3	1SNK916303R0000	25	M4/8.SF	1SNA115657R2500	76	SCD5.4L	1SNA291372R0000	95
JB16-4	1SNK916304R0000	25	M4/8.SF2	1SNA105135R1100	77	SCF12	1SNA113102R1000	24
JB16-5	1SNK916305R0000	25	M4/8.SFD	1SNA115663R2300	79	SCF6	1SNA118707R0300	14
JB22-10	1SNK922310R0000	26	M4/8.SFD3	1SNA115935R0400	78	SCF6D	1SNA118495R1700	46
JB22-2	1SNK922302R0000	26	M4/8.SFDT	1SNA115665R2500	79	SCFCV1-2	1SNA116795R1100	14
JB22-3	1SNK922303R0000	26	M4/8.SFL	1SNA115661R2100	79	SCFCV4	1SNA116797R1300	26
JB22-5	1SNK922305R0000	26	M4/8.SFLT	1SNA115667R2700	79	SCFM6	1SNA114825R0500	14
JB26-10	1SNK926310R0000	27	M4/8.SFT	1SNA115662R2200	77	SCFT1	1SNA103588R2600	67
JB26-2	1SNK926302R0000	27	M4/8.SN	1SNA115659R0700	80	SCFT2	1SNA114522R0500	71
JB26-3	1SNK926303R0000	27	M4/8.SNT	1SNA115668R0000	80	SC-JB8-2	1SNK900652R0000	71
JB26-5	1SNK926305R0000	27	M6/8	1SNA105004R2200	20	SC-JB8-3	1SNK900653R0000	71
M10/10	1SNA105120R2600	22		1SNA105118R2000	20	SC-JB8-4	1SNK900654R0000	71
	1SNA115120R1700	22		1SNA115118R1100	20	SCM6	1SNA113003R1000	16
	1SNA195120R1000	22		1SNA195118R1200	20	SCM6D	1SNA113482R0500	46
	1SNA400188R0300	22		1SNA400186R2100	20	SCMA5	1SNA116728R2500	14
	1SNA400189R0400	22		1SNA400187R2200	20	SCMA5D	1SNA116720R2100	44
	1SNA400190R0100	22		1SNA400239R1500	20	TGA13	1SNA168564R0500	86
M10/10.1	1SNA115261R2000	23	M6/8.1	1SNA105128R2200	21		1SNA168565R0600	86
M10/10.N	1SNA125120R1100	22		1SNA115260R0300	21		1SNA168566R0700	86
M10/10.P	1SNA165115R1000	38		1SNA195260R0400	21	TGA8	1SNA168672R1100	76
M16/12	1SNA105129R2300	24	M6/8.1.N	1SNA125260R0500	21		1SNA168673R1200	76
	1SNA115129R1400	24	M6/8.2	1SNA115218R2500	21		1SNA168674R1300	76
	1SNA195129R1500	24	M6/8.4	1SNA115219R2600	21			
	1SNA400191R2600	24	M6/8.D1	1SNA115498R1700	51			

Marketing material

www.abb.com

www.abb.com/connecttocontrol

Products → Low Voltage Products and Systems → Connection Devices

Catalogs

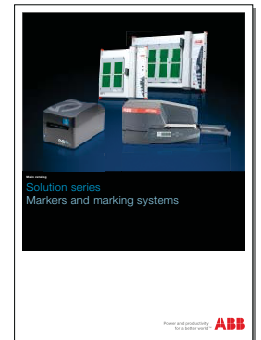
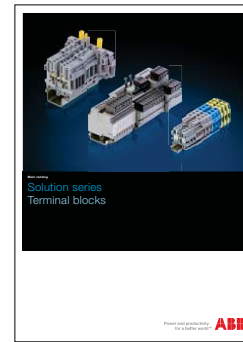
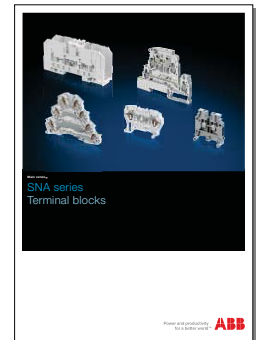
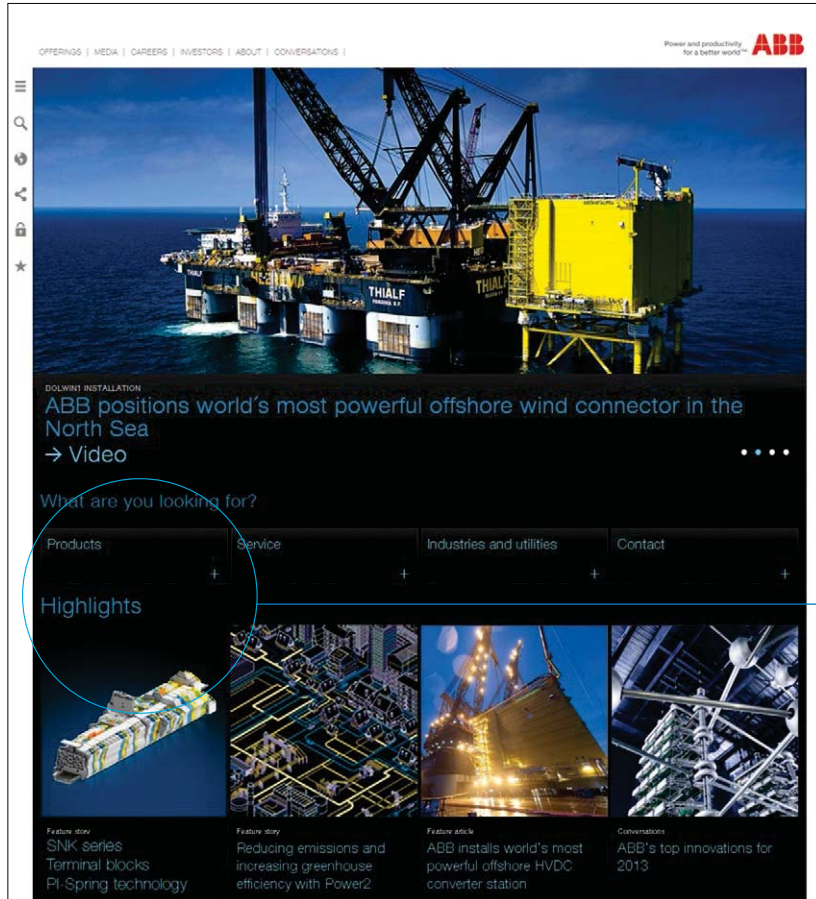

Tools

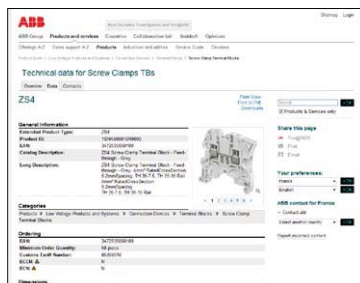

For product detailed information, use product type or order code, ex:
www.abb.com/productdetails/ZS4 or
www.abb.com/productdetails/1SNK505010R0000



Cadenas portal: Download 2D or 3D files according to your needs (STEP, IGES...)

New

SNK series terminal blocks in your pocket

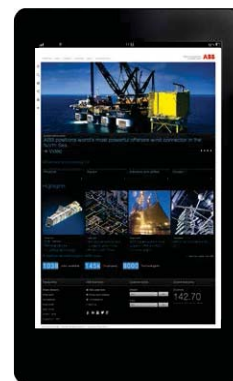

The ABB website compatible with Smartphones and tablets gives you all the information you need.

Always updated
 Always available
 Stay connected!

**Helsinki**

tel. +358 9 540 4940
automation@klinkmann.fi

Yekaterinburg

tel. +7 343 287 19 19
yekaterinburg@klinkmann.spb.ru

Vilnius

tel. +370 5 215 1646
post@klinkmann.lt

St. Petersburg

tel. +7 812 327 3752
klinkmann@klinkmann.spb.ru

Samara

tel. +7 846 273 95 85
samara@klinkmann.spb.ru

Tallinn

tel. +372 668 4500
klinkmann.est@klinkmann.ee

Moscow

tel. +7 495 641 1616
moscow@klinkmann.spb.ru

Kiev

tel. +38 044 495 33 40
klinkmann@klinkmann.kiev.ua

Minsk

tel. +375 17 200 0876
minsk@klinkmann.com

Riga

tel. +371 6738 1617
klinkmann@klinkmann.lv