



Short form catalog

# Motor protection and control

## Manual motor starters, contactors and overload relays

Power and productivity  
for a better world™



# Motor rated operational powers and currents

The currents given below concern standard three-phase four-pole cage motors (1500 r.p.m. at 50 Hz 1800 r.p.m. at 60 Hz). These values are given for guidance and may vary according to the motor manufacturer and depending on the number of poles.

IEC	Motor nominal current: standardized values in blue colour (according to IEC 60947-4-1 Annex G)									
Motor power kW	220 V A	230 V A	240 V A	380 V A	400 V A	415 V A	440 V A	500 V A	660 V A	690 V A
0.06	0.37	0.35	0.34	0.21	0.2	0.19	0.18	0.16	0.13	0.12
0.09	0.54	0.52	0.50	0.32	0.3	0.29	0.26	0.24	0.18	0.17
0.12	0.73	0.7	0.67	0.46	0.44	0.42	0.39	0.32	0.24	0.23
0.18	1	1	1	0.63	0.6	0.58	0.53	0.48	0.37	0.35
0.25	1.6	1.5	1.4	0.9	0.85	0.82	0.74	0.68	0.51	0.49
0.37	2.0	1.9	1.8	1.2	1.1	1.1	1	0.88	0.67	0.64
0.55	2.7	2.6	2.5	1.6	1.5	1.4	1.3	1.2	0.91	0.87
0.75	3.5	3.3	3.2	2.0	1.9	1.8	1.7	1.5	1.15	1.1
1.1	4.9	4.7	4.5	2.8	2.7	2.6	2.4	2.2	1.7	1.6
1.5	6.6	6.3	6	3.8	3.6	3.5	3.2	2.9	2.2	2.1
2.2	8.9	8.5	8.1	5.2	4.9	4.7	4.3	3.9	2.9	2.8
3	11.8	11.3	10.8	6.8	6.5	6.3	5.7	5.2	4	3.8
4	15.7	15	14.4	8.9	8.5	8.2	7.4	6.8	5.1	4.9
5.5	20.9	20	19.2	12.1	11.5	11.1	10.1	9.2	7	6.7
7.5	28.2	27	25.9	16.3	15.5	14.9	13.6	12.4	9.3	8.9
11	39.7	38	36.4	23.2	22	21.2	19.3	17.6	13.4	12.8
15	53.3	51	48.9	30.5	29	28	25.4	23	17.8	17
18.5	63.8	61	58.5	36.8	35	33.7	30.7	28	22	21
22	75.3	72	69	43.2	41	39.5	35.9	33	25.1	24
30	100	96	92	57.9	55	53	48.2	44	33.5	32
37	120	115	110	69	66	64	58	53	40.8	39
45	146	140	134	84	80	77	70	64	49.1	47
55	177	169	162	102	97	93	85	78	59.6	57
75	240	230	220	139	132	127	116	106	81	77
90	291	278	266	168	160	154	140	128	97	93
110	355	340	326	205	195	188	171	156	118	113
132	418	400	383	242	230	222	202	184	140	134
160	509	487	467	295	280	270	245	224	169	162
200	637	609	584	368	350	337	307	280	212	203
250	782	748	717	453	430	414	377	344	261	250
315	983	940	901	568	540	520	473	432	327	313
355	1109	1061	1017	642	610	588	535	488	370	354
400	1255	1200	1150	726	690	665	605	552	418	400
500	1545	1478	1416	895	850	819	745	680	515	493
560	1727	1652	1583	1000	950	916	832	760	576	551
630	1928	1844	1767	1116	1060	1022	929	848	643	615
710	2164	2070	1984	1253	1190	1147	1043	952	721	690
800	2446	2340	2243	1417	1346	1297	1179	1076	815	780
900	2760	2640	2530	1598	1518	1463	1330	1214	920	880
1000	3042	2910	2789	1761	1673	1613	1466	1339	1014	970

UL / CSA	Motor nominal current: standardized values (according to IEC 60947-4-1 Annex G and UL 508)				
Motor power hp	208 V A	220-240 V A	380-415 V A	440-480 V A	550-600 V A
1/2	2.4	2.2	1.3	1.1	0.9
3/4	3.5	3.2	1.8	1.6	1.3
1	4.6	4.2	2.3	2.1	1.7
1-1/2	6.6	6	3.3	3	2.4
2	7.5	6.8	4.3	3.4	2.7
3	10.6	9.6	6.1	4.8	3.9
5	16.7	15.2	9.7	7.6	6.1
7-1/2	24.2	22	14	11	9
10	30.8	28	18	14	11
15	46.2	42	27	21	17
20	59.4	54	34	27	22
25	74.8	68	44	34	27
30	88	80	51	40	32
40	114	104	66	52	41
50	143	130	83	65	52
60	169	154	103	77	62
75	211	192	128	96	77
100	273	248	165	124	99
125	343	312	208	156	125
150	396	360	240	180	144
200	528	480	320	240	192
250	-	604	403	302	242
300	-	722	482	361	289
350	-	828	560	414	336
400	-	954	636	477	382
450	-	1030	-	515	412
500	-	1180	786	590	472

# Motor protection and control

## Manual motor starters, contactors and overload relays

<a href="#">Overview</a>	1
<a href="#">Manual motor starters</a>	2
<a href="#">B mini contactors</a>	3
<a href="#">AS contactors with screw terminals</a>	4
<a href="#">DRAS enclosed starter</a>	5
<a href="#">AF and EK contactors with screw terminals</a>	6
<a href="#">Overload relays</a>	7
<a href="#">R contactors</a>	8
<a href="#">General technical data</a>	9
<a href="#">Index</a>	10
<a href="#">Marketing material</a>	11



More product information and technical data available in main catalog 1SBC100192C0202

For direct product details information, use product type or order code, ex:  
[www.abb.com/productdetails/AF09-30-10-13](http://www.abb.com/productdetails/AF09-30-10-13) or [www.abb.com/productdetails/1SBL137001R1310](http://www.abb.com/productdetails/1SBL137001R1310)

# ABB sets a new standard in motor control and power switching

1

Featuring AF technology as standard, the latest range of ABB's contactors establishes a new industry benchmark. The electronically controlled coil offers multiple benefits over conventional alternatives, and together with ABB's wide product offering – an optimal configuration, every time.



## Access Global Support

The contactor and motor protection range from ABB is compatible with all major national and international standards and is available worldwide via a global distribution network. One contactor coil now handles 100 V – 250 V, AC/DC for use in Europe or Asia as well as North America.



## Simplify design

By reducing contactor coil energy consumption by up to 80%, panels can be built smaller and transformers more compact. All the features of the AF technology, along with access to drawings and coordination tables online, simplifies your design and assembly process.



## Optimize logistics

With its contactor and motor protection range, ABB has managed to reduce the number of contactor coils to just four. The total number of product variants has been reduced by up to 90%. This simplifies the customers' logistics and cuts administration costs.

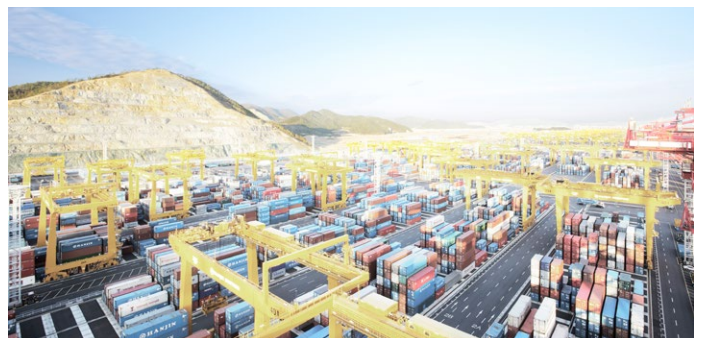

## Secure uptime

Time to prevent stoppages caused by voltage fluctuations. The AF contactor ensures distinct operation in unstable networks and signifies a major advance in motor control and power switching. Voltage sags, dips and surges pose no threat. The AF contactor secures your uptime.



## MacGregor. Keeping turnarounds brief.

Until the AF range was installed, voltage sags were affecting MacGregor's deck cranes. Conventional contactors welded shut, leading to several stoppages a week. No longer. Known for superior quality and an ability to operate in the most hostile environments, MacGregor deck cranes enjoy a global reputation for reliability. A small but vital component, the AF contactor helps maintain this reputation.

To keep things moving, you need Control. Connect to Control.

Explore all our case studies at [www.abb.com/connecttocontrol](http://www.abb.com/connecttocontrol)

**SSAB**  
Making certainty  
standard

**Gamesa**  
Taming the wind

**LKAB**  
Providing fresh air

# Contactors and motor protection

## For a wide variety of segments

1

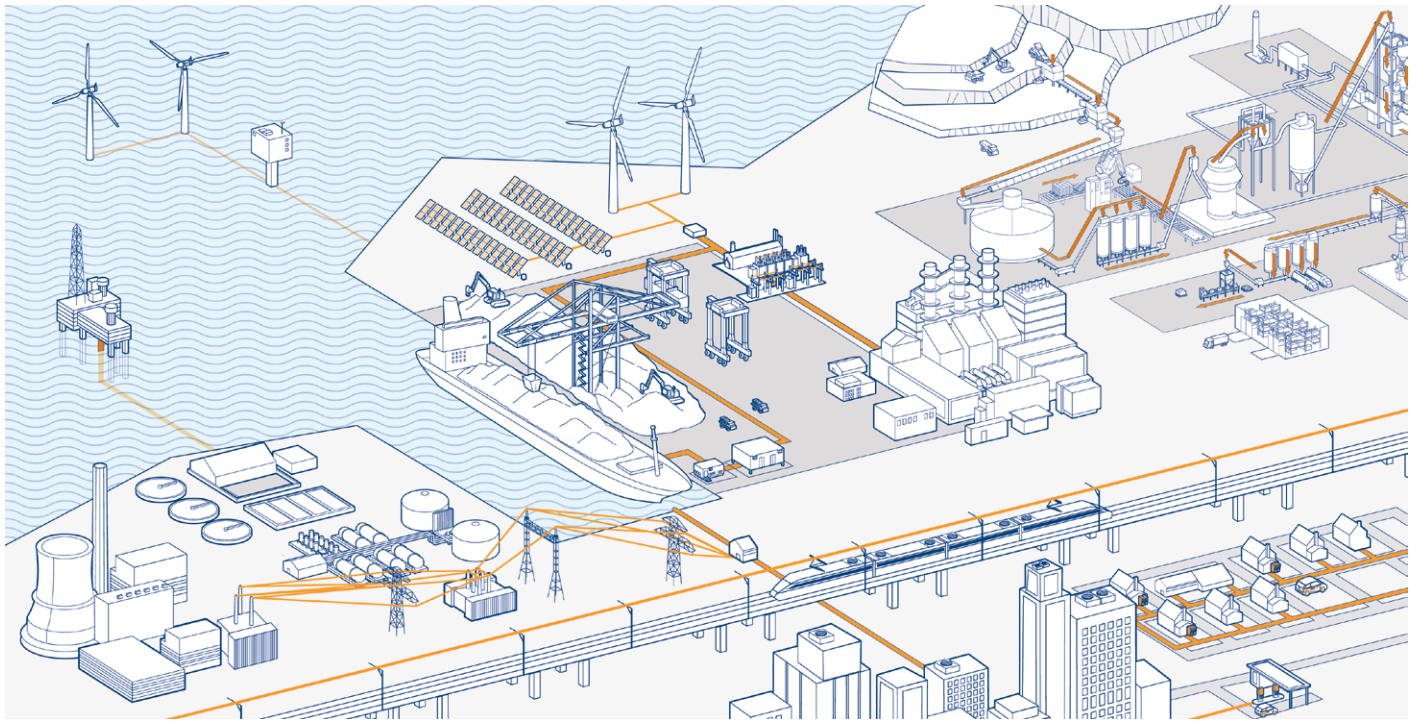

HVAC, General Machinery, Rail, Critical Power, Wind, Solar, Marine and Water & Wastewater

### Contactors for any use

The AF contactor range covers small motor starting solutions from 4 kW / 5 hp up to big power switching solutions with our unique AF2650, the biggest single case block contactor in the world.

The contactor and motor protection range is part of one of the widest product offerings on the market meaning that ABB not only can provide the contactor but the full solution.

In addition to the standard product range ABB also offer products for special needs such as Bar contactors, GAF and contactors for capacitor switching.

### Cooperating with customers

ABB cooperates closely with its customers to ensure that products meet requirements from their specific segments and applications. With over 100 years' experience in motor control and power switching ABB knows how to create efficient solutions for its customers.

# AF technology

## Benefits



### Reliable in all networks

The electronic system within the AF contactor rectifies the AC or DC control circuit voltage to a DC control voltage that is applied on the coil. The contactor is safely operated in an always optimized condition making it virtually noise free.

### Four coils for the entire voltage range

The AF contactor features both AC and DC support. With the complete AF contactor range, functionality is improved. Still, the total number of product variants compared to a conventional range is reduced by 90 %. Only four coils are required to cover 24 V AC, 20 V DC - 500 V AC/DC.

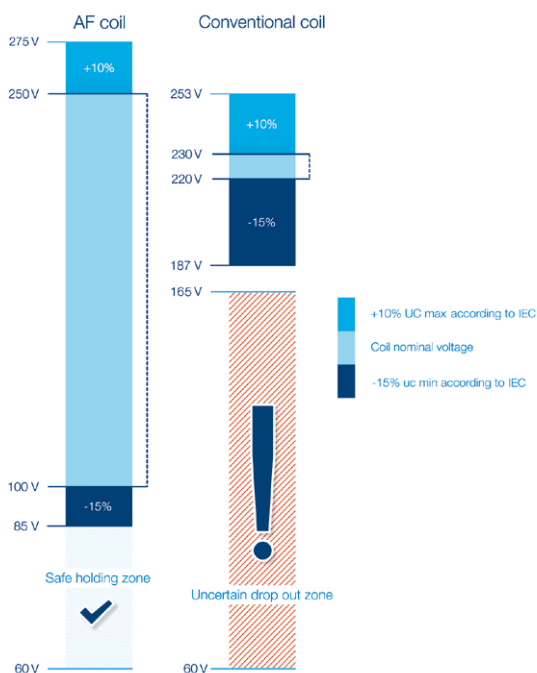

### Wide control voltage range

With conventional contactor technology, different contactors were needed for different network voltages. Thanks to the wide operating range of the AF contactor it can operate just as well in Europe as in Asia or North America. The core coil of the AF contactor range covers 100-250 V AC/DC 50/60 Hz.

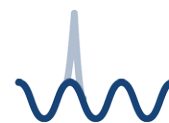

### Built-in surge suppression

With conventional contactor technology it is recommended to use an external surge suppressor, an accessory that could cost as much as half the contactor itself. With the AF technology the surges are handled by the contactor itself and the surge never reaches the control circuit. Neither the surge suppressor nor the actual surge has to be considered anymore. One less product and one less complication to worry about.

# Contactors and motor protection

## Advanced but simple

1

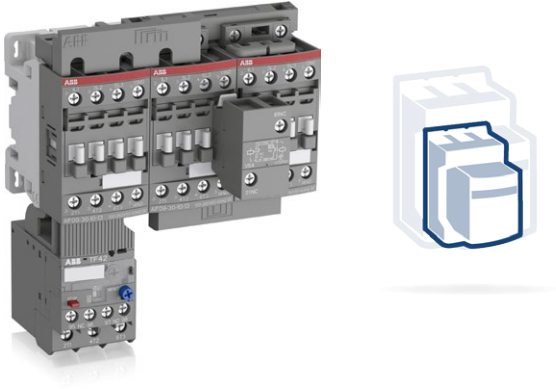

### The AF contactor is compact

The AF contactor is compact in size and has had its width reduced by up to 30 % thanks to an 80 % reduction of the coil's energy consumption.



### The AF contactor is flexible

AF09 ... AF370 is perfect for motor starting applications and for solutions where space is limited. Interlocked reversing pairs require no spacing between contactors meaning you can fit more functionality into cabinets or other small enclosures.



### Coil terminal access in the front

The AF contactor has its coil terminals accessible from the front. The cables or bars do not have to be disconnected in order to perform voltage measurement or servicing work.

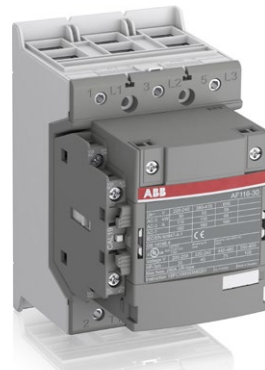

### More functionality without adding width

The AF116 ... AF2650 can take up to 2 side mounted auxiliary contact blocks without adding to its width and are delivered with 1 N.O. + 1 N.C. as standard.





# Contactors and motor protection

## Mechanical features

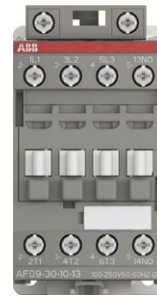
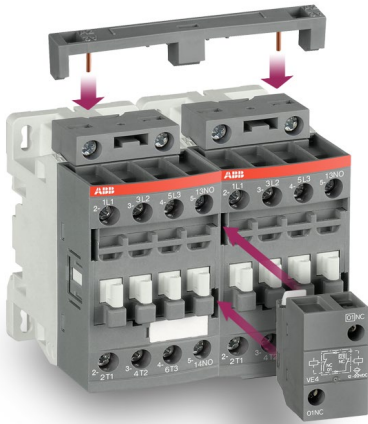

Top-mounted

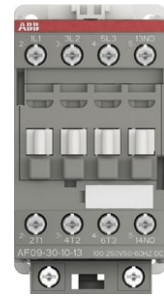

Bottom-mounted

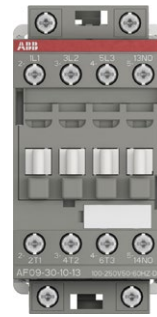

Additional LDC4  
coil terminal block



Front-mounted

### Easy-to-use accessories

Contactors up to 96 A offer free choice of coil terminal access and can take side and front mounted auxiliary contact blocks. All the accessories: Coil connection terminals, mechanical and electrical interlocks and electronic timers are easily connected through the snap-to-connect function.



### Safe control circuit with:

- Mirror contact according to IEC 60947-4-1
- Mechanically linked contacts according to IEC 60947-5-1
- Sealable and transparent protective covers on AF09 ... AF96 and overload relays TF/EF

# 3-pole contactors

# Mini contactors

# Contactors for motor control and

1



IEC (1)	AC-3 Rated operational power	$\theta \leq 60^\circ\text{C}$ (2), 400 V	kW	4	5.5
UL/CSA	3-phase motor rating	480 V	hp	3	5
AC / DC Control supply		Type	—	—	
AC Control supply		Type	B6	B7	
DC Control supply		Type	BC6	BC7	
IEC	AC-3 Rated operational current	$\theta \leq 60^\circ\text{C}$ (2), 400 V	A	8.5	11.5
	AC-1 Rated operational current	$\theta \leq 40^\circ\text{C}$ , 690 V	A	20 (400 V)	20 (400 V)
UL/CSA	General use rating	600 V	A	12 (300 V)	16
NEMA	NEMA Size			—	—

4	5.5	7.5	4	5.5	7.5	11	15	18.5
5	7.5	10	5	7.5	10	15	20	25
—	—	—	AF09	AF12	AF16	AF26	AF30	AF38
AS09	AS12	AS16	AF09	AF12	AF16	AF26	AF30	AF38
ASL09	ASL12	ASL16	AF09	AF12	AF16	AF26	AF30	AF38
9	12	15.5	9	12	18	26	32	38
22	24	24	25	28	30	45	50	50
20	20	20	25	28	30	45	50	50
00	00	0	00	0	—	1	—	—

(1) 1000 V IEC ratings available for AF80, AF96 and AF146 ... AF2650 contactors.  
 (2)  $\theta \leq 55^\circ\text{C}$  for mini contactors and AF400 ... AF2650 contactors.

## Main accessories

Auxiliary contact blocks	Front mounting	CAF6
	Side mounting	CA6
Timers	Electronic	
	Mechanical	
Interlocking units (3)	Mechanical / Electrical	
Connection sets	For reversing contactors	BSM6-30
Surge suppressors	Varistor (AC/DC)	RV-BC6
	RC type (AC)	
	Transil diode (DC)	RD7

CA3-10 (1 x N.O.) CA3-01 (1 x N.C.)	CA4-10 (1 x N.O.) CA4-01 (1 x N.C.) CAL4-11 (1 x N.O. + 1 x N.C.)
TEF3-ON TEF3-OFF VM3	TEF4-ON TEF4-OFF VM4
BER16C-3 RV5 (24...440 V) RC5-1 (24...440 V) RT5 (12...264 V)	VEM4 BER16-4 BER38-4 Built-in surge protection

(3) See available reversing contactors VB6, VB7 and VAS09 ... VAS16.

## Overload relays

Thermal relays		Class 10 (Class 10A for TF140, TA200DU)	T16 (0.10...16 A)
Electronic relays		Class 10E, 20E, 30E	E16DU (0.10...18.9 A)

T16 (0.10...16 A)	TF42 (0.10...38 A)
	EF19 (0.10...18.9 A) EF19 (0.10...18.9 A) EF45 (9...45 A)

## Manual motor starters

	Thermal / magnetic protection Class 10	MS116 (0.10...32 A) lcs up to 50 kA for class 10A
		MS132 (0.10...32 A) lcs up to 100 kA
	Magnetic only types	MO132 (0.16...32A)
Accessories	For contactor mounting	BEA7/132

MS116 (0.10...32 A) lcs up to 50 kA for class 10 A	MS450 (28...50 A) lcs up to 50 kA
MS132 (0.10...32 A) lcs up to 100 kA	MS497 (22...100 A) lcs up to 100 kA
MO132 (0.16...32 A) lcs up to 100 kA	
BEA16-3	BEA16-4 BEA38-4

# power switching

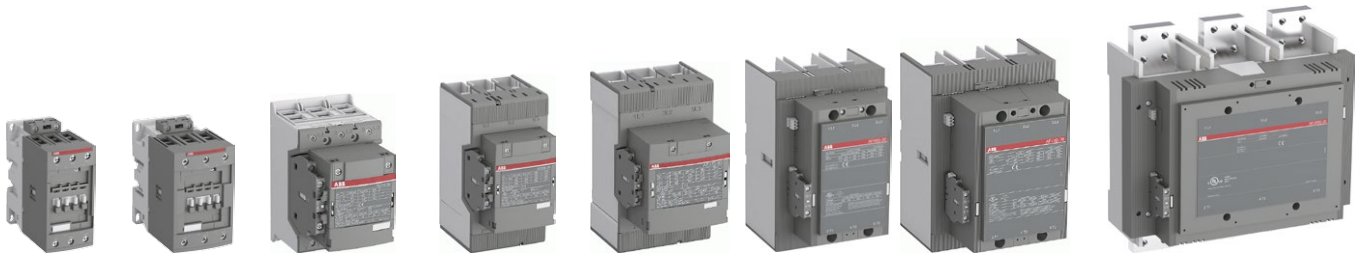

1

18.5	22	30	37	45	55	75	75	90	110	132	160	200	200	250	315	400	—	475	560	—	—																								
30	40	50	60	60	75	100	100	125	150	200	250	300	350	400	500	600	—	800	900	—	—																								
AF40		AF52		AF65		AF80		AF96		AF116		AF140		AF146		AF190		AF205		AF265		AF305		AF370		AF400		AF460		AF580		AF750		AF1250		AF1350				AF1650		AF2050		AF2650	
AF40		AF52		AF65		AF80		AF96		AF116		AF140		AF146		AF190		AF205		AF265		AF305		AF370		AF400		AF460		AF580		AF750		AF1250		AF1350				AF1650		AF2050		AF2650	
AF40		AF52		AF65		AF80		AF96		AF116		AF140		AF146		AF190		AF205		AF265		AF305		AF370		AF400		AF460		AF580		AF750		AF1250		AF1350				AF1650		AF2050		AF2650	
40	53	65	80	96	116	140	146	190	205	265	305	370	400	460	580	750	—	860	1060	—	—																								
70	100	105	125	130	160	200	225	275	350	400	500	600	600	700	800	1050	1260	1350	1650	2050	2650																								
60	80	90	105	115	160	200	200	250	300	350	400	520	550	650	750	900	1210	1350	1650	2100	2700																								
2	—	—	3	—	—	4	—	—	—	5	—	—	—	6	—	7	—	—	8	—	—																								

		CAL19-11 (1 x N.O. + 1 x N.C.)					CAL18-11 (1 x N.O. + 1 x N.C.)						
VM96-4			VM19 (for same size contactors)					VM750H VM750V			VM1650H		
BER65-4	BER96-4	BER140-4	BER205-4	BER370-4	BEM460-30	BEM750-30							

TF65 (22...67 A)	TF96 (40...96 A)	TF140DU (66...142 A) $\theta \leq 55^\circ\text{C}$	TA200DU (66...200 A) $\theta \leq 55^\circ\text{C}$	EF65 (20...70 A)	EF96 (36...100 A)	EF146 (54...150 A)	EF205 (63...210 A)	EF370 (115...380 A)	EF460 (150...500 A)	EF750 (250...800 A)	E1250DU (375...1250 A)
------------------	------------------	--	--	------------------	-------------------	--------------------	--------------------	---------------------	---------------------	---------------------	------------------------

## Short-circuit protection devices

### MCCB and switch-fuses

MS495 (45...100 A) lcs up to 50 kA	
MO496 (32...100 A) lcs up to 100 kA	
MO450 (40...50 A) lcs up to 50 kA	MO495 (63...100 A) lcs up to 50 kA



## 4-pole contactors

## Mini contactors

1



IEC	AC-1 Rated operational current	$\theta \leq 40^\circ\text{C}$ , 690 V	A	<b>16</b>	<b>20</b>
UL/CSA	General use rating	600 V	A	<b>12</b> (300 V)	<b>16</b>
AC / DC Control supply			Type	—	—
AC Control supply			Type	<b>B6</b>	<b>B7</b>
DC Control supply			Type	<b>BC6</b>	<b>BC7</b>

## Contactor relays

## Mini contactor relays



IEC	AC-15 Rated operational current	400 V	A	<b>3</b>
UL/CSA	Pilot duty			<b>A600</b>
AC Control supply			Type	<b>K6-22Z</b> <b>K6-31Z</b> <b>K6-40E</b>
DC Control supply			Type	<b>KC6-22Z</b> <b>KC6-31Z</b> <b>KC6-40E</b>
AC / DC Control supply			Type	—   —   —

## R contactors

## DC Circuit switching



DC-1 Rated current up to 5000 A  
 DC-3/DC-5 Rated current up to 2000 A  
 1500 V with poles in series

IOR.. 63-...-CC to IOR.. 5100-...-CC

## Specific contactors

## DC Circuit switching



100 A, 440 V, DC-1  
**GA75, GAE75** types



275 to 2050 A, 1000 V, DC-1  
**GAF185 to GAF2050** types

## Contactors



25	30	45	55	70	100	125	160	200	275	350	400	500	525	800	1000
25	30	45	55	60	80	105	160	175	230	250	300	350	420	540	—
AF09	AF16	AF26	AF38	AF40	AF52	AF80	AF116	AF140	AF190	AF205	AF265	AF305	AF370	—	—
AF09	AF16	AF26	AF38	AF40	AF52	AF80	AF116	AF140	AF190	AF205	AF265	AF305	AF370	EK550	EK1000
AF09	AF16	AF26	AF38	AF40	AF52	AF80	AF116	AF140	AF190	AF205	AF265	AF305	AF370	EK550	EK1000

## Contactor relays

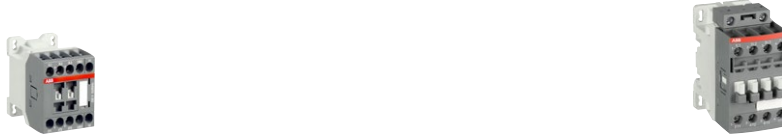

3			3		
A600, Q300			A600, Q600		
NS22E	NS31E	NS40E	NF22E	NF31E	NF40E
NSL22E	NSL31E	NSL40E	NF22E	NF31E	NF40E
—	—	—	NF22E	NF31E	NF40E

## AC Circuit switching

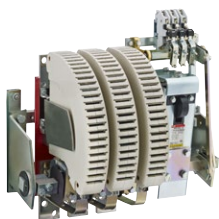

AC-1 Rated current up to 5000 A  
AC-3 Rated power up to 1500 kW  
(1520 A - 440 V)

IOR.. 63-...-MT to IOR.. 5100-...-MT

## Special versions

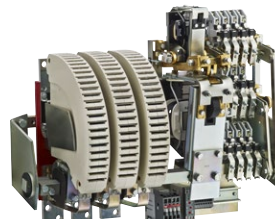

AC/DC Coupling: LOR.. contactors  
Slip ring motor control: FOR .. contactors  
Field discharge: AM(F)-CC-JORE contactors  
AC/DC Switching (N.C./N.O. main poles):  
NOR & JOR contactors  
Latching contactors for energy saving  
and safety requirements: AMA or AME contactors

## Capacitor switching



12.5 to 80 kvar  
UA16..RA to UA110..RA types  
UA16 to UA110 types



# Manual motor starters

<b>Benefits - Features</b>	<b>2/2</b>
<b>Overview</b>	<b>2/4</b>
<b>0.10 to 32 A – with thermal and electromagnetic protection</b>	
<b>I<sub>cs</sub> up to 50 kA</b>	
MS116 manual motor starters	2/6
<b>I<sub>cs</sub> up to 100 kA</b>	
MS132 manual motor starters	2/7
<b>0.16 to 32 A – with electromagnetic protection</b>	
MO132 manual motor starters magnetic only	2/8
<b>0.10 to 25 A – with thermal and electromagnetic protection</b>	
MS132-T circuit breakers for transformer protection	2/9
Main accessories	2/10
<b>22 to 100 A – with thermal and electromagnetic protection</b>	
MS450, MS495, MS497 manual motor starters	2/16
<b>32 to 100 A – with electromagnetic protection</b>	
MO450, MO495, MO496 manual motor starters magnetic only	2/17
Main accessories	2/18
<b>0.10 to 25 A – with thermal and electromagnetic protection</b>	
MS325 manual motor starters with modular DIN rail design	2/21
<b>0.4 to 25 A – with thermal and electromagnetic protection</b>	
MO325 manual motor starters magnetic only	
with modular DIN rail design	2/22
Main accessories	2/23
General accessories	2/26

For direct product details information, use product type or order code, ex:  
[www.abb.com/productdetails/AF09-30-10-13](http://www.abb.com/productdetails/AF09-30-10-13) or [www.abb.com/productdetails/1SBL137001R1310](http://www.abb.com/productdetails/1SBL137001R1310)

# Manual motor starters

## Benefits

### Safe, compact, and cost-saving solution

Various motor protection functions in one device

- Overload
- Short-circuit
- Phase loss sensitivity

Efficient planning and installation perfectly matching the ABB contactor family, leads to high flexibility and increased exchangeability. Simple connecting links ensure the electrical and mechanical connection.

### Products range for different applications available

- Short-circuit breaking capacity up to 100 kA
- Magnetic-only devices (only short-circuit protection)
- Selected types are certified according to ATEX
- Special version for transformer protection

The manual motor starter range is compatible with all major national and international standards.

### Comprehensive accessory range

Manual motor starters can be equipped with busbars, auxiliary contacts, signalling contacts, undervoltage releases and shunt trips. Moreover it is possible to order IP65 door mounting kits, IP65 enclosures and shafts for doors.



Manual motor starters with busbar connection



Product range



Accessory range



Direct-on-line starters

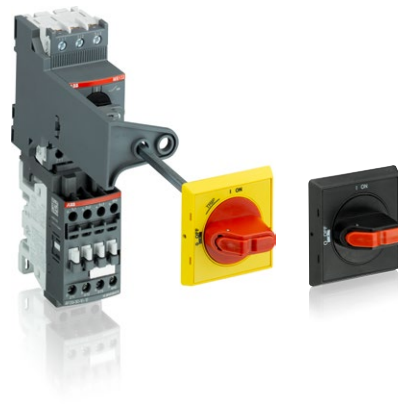

Door mounting kits



# Manual motor starters

## Features

### Features

- Manual control
- Disconnect function
- Handle can be locked in the off position
- Remote control via undervoltage release or shunt trip
- Trip indication
- Temperature compensation
- Adjustable current setting

- Magnetic trip indication for several types available (MS132, and MS132-T)
- One product family in 45 mm width (MS116, MS132, MO132, and MS132-T)
- 15 setting ranges from 0.1 up to 32 A (MS116, MS132, MO132)
- Short-circuit service breaking capacity  $I_{cs}$  up to 100 kA

- 1 Terminals (1L1, 3L2, 5L3)
- 2 Switch position TRIP
- 3 Lockable handle
- 4 Test function
- 5 Status indication for short-circuit
- 6 Current setting range
- 7 Terminals 2T1, 4T2, 6T3

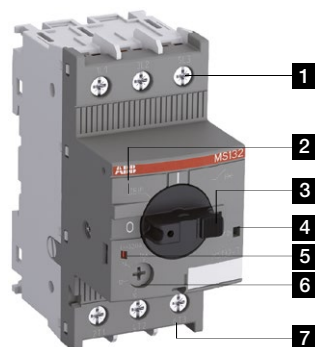

Features of type MS132

- 1 Clear trip indication
- 2 Handle in TRIP position
- 3 Optical indication for short-circuit
- 4 Easy locking

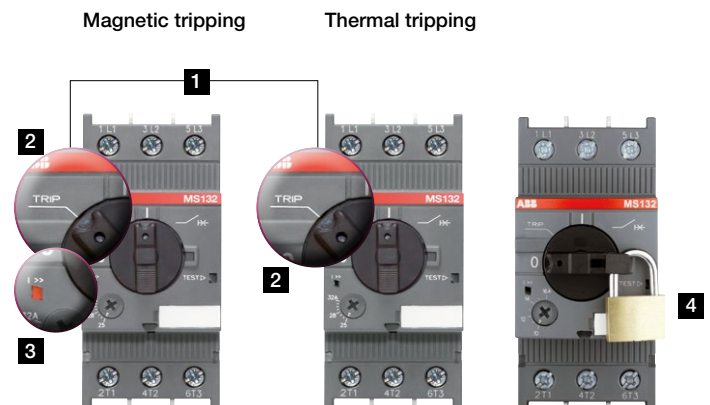

TRIP indication

# Manual motor starters



2

Type	MS116	MS132	MS450	MS495	MS497	MS325
Thermal and electromagnetic protection	Yes	Yes	Yes	Yes		Yes
Electromagnetic protection	-	-	-	-		-
Phase loss sensitivity	Yes	Yes	Yes	Yes		Yes
Switch position	ON/OFF	ON/OFF/TRIP	ON/OFF/TRIP	ON/OFF/TRIP		ON/OFF
Magnetic trip indication	-	Yes	-	-		-
Lockable handle without accessories	-	Yes	Yes	Yes		-
Disconnecting feature	Yes	Yes	Yes	Yes		Yes
Width	45 mm	45 mm	55 mm	70 mm		54 mm
Rated operational current $I_e$	0.16 ... 32 A	0.16 ... 32 A	40 ... 50 A	63 ... 100 A	32 ... 100 A	0.16 ... 25 A
Setting range	0.1 ... 32 A	0.1 ... 32 A	28 ... 50 A	45 ... 100 A	22 ... 100 A	0.1 ... 25 A
Ambient air temperature	-25 ... +55 °C *)	-25 ... +60 °C *)	-20 ... +60 °C *)	-20 ... +60 °C *)		-25 ... +50 °C *)

\*) Compensated

Table for short-circuit ratings for 400 V

Standard range	High performance range	Modular DIN rail design
MS116, MS450, MS495	MS132, MS497	MS325

## Selection parameters

Rated operational power	Setting range for thermal release	Type	Short-circuit breaking capacity		Type	Short-circuit breaking capacity		Type	Short-circuit breaking capacity
			$I_{cu}$	$I_{cs}$		$I_{cu}$	$I_{cs}$		
0.03 kW	0.1 ... 0.16 A	MS116-0.16	50 kA	50 kA	MS132-0.16	100 kA	100 kA	MS325-0.16	100 kA
0.06 kW	0.16 ... 0.25 A	MS116-0.25	50 kA	50 kA	MS132-0.25	100 kA	100 kA	MS325-0.25	100 kA
0.09 kW	0.25 ... 0.4 A	MS116-0.4	50 kA	50 kA	MS132-0.4	100 kA	100 kA	MS325-0.4	100 kA
0.18 kW	0.4 ... 0.63 A	MS116-0.63	50 kA	50 kA	MS132-0.63	100 kA	100 kA	MS325-0.63	100 kA
0.25 kW	0.63 ... 1.0 A	MS116-1.0	50 kA	50 kA	MS132-1.0	100 kA	100 kA	MS325-1	100 kA
0.55 kW	1.0 ... 1.6 A	MS116-1.6	50 kA	50 kA	MS132-1.6	100 kA	100 kA	MS325-1.6	100 kA
0.75 kW	1.6 ... 2.5 A	MS116-2.5	50 kA	50 kA	MS132-2.5	100 kA	100 kA	MS325-2.5	100 kA
1.5 kW	2.5 ... 4.0 A	MS116-4.0	50 kA	50 kA	MS132-4.0	100 kA	100 kA	MS325-4	100 kA
2.2 kW	4.0 ... 6.3 A	MS116-6.3	50 kA	50 kA	MS132-6.3	100 kA	100 kA	MS325-6.3	100 kA
4.0 kW	6.3 ... 10 A	MS116-10	50 kA	50 kA	MS132-10	100 kA	100 kA	MS325-9	100 kA
5.5 kW	8 ... 12 A	MS116-12	25 kA	25 kA	MS132-12	100 kA	100 kA	MS325-12.5	75 kA
7.5 kW	10 ... 16 A	MS116-16	16 kA	16 kA	MS132-16	100 kA	100 kA	MS325-16	60 kA
7.5 kW	16 ... 20 A	MS116-20	15 kA	10 kA	MS132-20	100 kA	100 kA	MS325-20	55 kA
11 kW	20 ... 25 A	MS116-25	15 kA	10 kA	MS132-25	50 kA	50 kA	MS325-25	50 kA
15 kW	25 ... 32 A	MS116-32	10 kA	10 kA	MS132-32	50 kA	25 kA		
15 kW	22 ... 32 A	MS132-32	50 kA	25 kA	MS497-32	100 kA	50 kA		
18.5 kW	28 ... 40 A	MS450-40	50 kA	25 kA	MS497-40	100 kA	50 kA		
22 kW	36 ... 45 A	MS450-45	50 kA	25 kA	MS497-50	100 kA	50 kA		
22 kW	40 ... 50 A	MS450-50	50 kA	25 kA	MS497-50	100 kA	50 kA		
30 kW	45 ... 63 A	MS495-63	50 kA	25 kA	MS497-63	100 kA	50 kA		
37 kW	57 ... 75 A	MS495-75	50 kA	25 kA	MS497-75	100 kA	50 kA		
45 kW	70 ... 90 A	MS495-90	50 kA	25 kA	MS497-90	100 kA	50 kA		
55 kW	80 ... 100 A	MS495-100	50 kA	25 kA	MS497-100	100 kA	50 kA		

The currents given above concern standard three-phase four-pole cage motors (1500 r.p.m. at 50 Hz 1800 r.p.m. at 60 Hz).



MO132	MO450	MO495	MO496	MO325	MS132-T
-	-	-	-	-	Yes
Yes	Yes	Yes	-	Yes	-
-	-	-	-	-	Yes
ON/OFF/TRIP	ON/OFF/TRIP	ON/OFF/TRIP	-	ON/OFF	ON/OFF/TRIP
-	-	-	-	-	Yes
Yes	Yes	Yes	-	Yes	Yes
Yes	Yes	Yes	-	Yes	Yes
45 mm	55 mm	70 mm	-	54 mm	45 mm
0.16 ... 32 A	40 ... 50 A	63 ... 100 A	32 ... 100 A	0.4 ... 25 A	0.16 ... 32 A
-	-	-	-	-	0.1 ... 25 A
-25 ... +60 °C	-20 ... +60 °C	-20 ... +60 °C	-	-25 ... +50 °C	-25 ... +60 °C *)

Standard range MO132, MO450, MO495	High performance range MO132, MO496	Modular DIN rail design MO325	Transformer protection MS132-T
---------------------------------------	--	----------------------------------	-----------------------------------

Type	Short-circuit breaking capacity		Type	Short-circuit breaking capacity		Type	Short-circuit breaking capacity	Type	Short-circuit breaking capacity
	I <sub>cu</sub>	I <sub>cs</sub>		I <sub>cu</sub>	I <sub>cs</sub>				
MO132-0.16	100 kA	100 kA	MO132-0.16	100 kA	100 kA			MS132-0.16T	100 kA
MO132-0.25	100 kA	100 kA	MO132-0.25	100 kA	100 kA			MS132-0.25T	100 kA
MO132-0.4	100 kA	100 kA	MO132-0.4	100 kA	100 kA	MO325-0.4	100 kA	MS132-0.4T	100 kA
MO132-0.63	100 kA	100 kA	MO132-0.63	100 kA	100 kA	MO325-0.63	100 kA	MS132-0.63T	100 kA
MO132-1.0	100 kA	100 kA	MO132-1.0	100 kA	100 kA	MO325-1	100 kA	MS132-1.0T	100 kA
MO132-1.6	100 kA	100 kA	MO132-1.6	100 kA	100 kA	MO325-1.6	100 kA	MS132-1.6T	100 kA
MO132-2.5	100 kA	100 kA	MO132-2.5	100 kA	100 kA	MO325-2.5	100 kA	MS132-2.5T	100 kA
MO132-4.0	100 kA	100 kA	MO132-4.0	100 kA	100 kA	MO325-4	100 kA	MS132-4.0T	100 kA
MO132-6.3	100 kA	100 kA	MO132-6.3	100 kA	100 kA	MO325-6.3	100 kA	MS132-6.3T	100 kA
MO132-10	100 kA	100 kA	MO132-10	100 kA	100 kA	MO325-9	100 kA	MS132-10T	100 kA
MO132-12	100 kA	100 kA	MO132-12	100 kA	100 kA	MO325-12.5	75 kA	MS132-12T	100 kA
MO132-16	100 kA	100 kA	MO132-16	100 kA	100 kA	MO325-16	60 kA	MS132-16T	100 kA
MO132-20	100 kA	100 kA	MO132-20	100 kA	100 kA	MO325-20	55 kA	MS132-20T	100 kA
MO132-25	50 kA	50 kA	MO132-25	50 kA	50 kA	MO325-25	50 kA	MS132-25T	50 kA
MO132-32	50 kA	25 kA	MO132-32	50 kA	25 kA			Transformer protection: The instantaneous short-circuit current setting is 20 times the rated operational current.	
MO132-32	50 kA	25 kA	MO496-32	100 kA	50 kA				
MO450-40	50 kA	25 kA	MO496-40	100 kA	50 kA				
MO450-45	50 kA	25 kA	MO496-50	100 kA	50 kA				
MO450-50	50 kA	25 kA	MO496-50	100 kA	50 kA				
MO495-63	50 kA	25 kA	MO496-63	100 kA	50 kA				
MO495-75	50 kA	25 kA	MO496-75	100 kA	50 kA				
MO495-90	50 kA	25 kA	MO496-90	100 kA	50 kA				
MO495-100	50 kA	25 kA	MO496-100	100 kA	50 kA				

For motor protection, an appropriate thermal or electronic overload relay must be used.

# MS116 manual motor starters

## 0.10 to 32 A – with thermal and electromagnetic protection

2



2CDC241010F0011

MS116-16



2CDC241001F0011

MS116-25



2CDC241013F0011

MS116-0.16-HKF1-11



2CDC241012F0011

MS116-32-HKF1-11

### Description

Manual motor starters (MMS) are protection devices for the main circuit. They combine motor control and protection in a single device. MMS are used mainly to switch motors manually ON/OFF and protect them and the installation fuse-less against short-circuit, overload and phase failures. Fuse-less protection with a manual motor starter saves costs, space and ensures a quick reaction under short-circuit condition, by switching off the motor within milliseconds.

MS116 is a compact and economic range for motor protection up to 15 kW (400 V) / 32 A in width of 45 mm. Further features are the build-in disconnect function, temperature compensation, trip-free mechanism and a rotary handle with a clear switch position indication. The manual motor starter is suitable for three- and single-phase applications. Auxiliary contacts, signaling contacts, undervoltage releases, shunt trips, three-phase bus bars, power in-feed blocks and locking devices for protection against unauthorized changes are available as accessory.

### Ordering details

Rated operational power 400 V AC-3	Setting range	Short-circuit breaking capacity $I_{cs}$ at 400 V AC	Rated instantaneous short-circuit current setting $I_i$	Type	Order code	Weight (1 pcs)
kW	A	kA	A			kg
0.03	0.10 ... 0.16	50	2.00 <sup>1)</sup>	MS116-0.16	1SAM250000R1001	0.225
0.06	0.16 ... 0.25	50	3.10 <sup>1)</sup>	MS116-0.25	1SAM250000R1002	0.225
0.09	0.25 ... 0.40	50	5.00 <sup>1)</sup>	MS116-0.4	1SAM250000R1003	0.225
0.12	0.40 ... 0.63	50	7.90 <sup>1)</sup>	MS116-0.63	1SAM250000R1004	0.225
0.25	0.63 ... 1.00	50	12.5 <sup>1)</sup>	MS116-1.0	1SAM250000R1005	0.225
0.55	1.00 ... 1.60	50	20.0 <sup>1)</sup>	MS116-1.6	1SAM250000R1006	0.265
0.75	1.60 ... 2.50	50	31.3 <sup>1)</sup>	MS116-2.5	1SAM250000R1007	0.265
1.5	2.50 ... 4.00	50	50.0	MS116-4.0	1SAM250000R1008	0.265
2.2	4.00 ... 6.30	50	78.8	MS116-6.3	1SAM250000R1009	0.265
4.0	6.30 ... 10.0	50	150	MS116-10	1SAM250000R1010	0.265
5.5	8.00 ... 12.0	25	180	MS116-12	1SAM250000R1012	0.265
7.5	10.0 ... 16.0	16	240	MS116-16	1SAM250000R1011	0.265
7.5	16.0 ... 20.0	10	300	MS116-20	1SAM250000R1013	0.310
11	20.0 ... 25.0	10	375	MS116-25	1SAM250000R1014	0.310
15	25.0 ... 32.0	10	480	MS116-32	1SAM250000R1015	0.310
0.03	0.10 ... 0.16	50	2.00 <sup>1)</sup>	MS116-0.16-HKF1-11	1SAM250005R1001	0.240
0.06	0.16 ... 0.25	50	3.10 <sup>1)</sup>	MS116-0.25-HKF1-11	1SAM250005R1002	0.240
0.09	0.25 ... 0.40	50	5.00 <sup>1)</sup>	MS116-0.4-HKF1-11	1SAM250005R1003	0.240
0.12	0.40 ... 0.63	50	7.90 <sup>1)</sup>	MS116-0.63-HKF1-11	1SAM250005R1004	0.240
0.25	0.63 ... 1.00	50	12.5 <sup>1)</sup>	MS116-1.0-HKF1-11	1SAM250005R1005	0.240
0.55	1.00 ... 1.60	50	20.0 <sup>1)</sup>	MS116-1.6-HKF1-11	1SAM250005R1006	0.280
0.75	1.60 ... 2.50	50	31.3 <sup>1)</sup>	MS116-2.5-HKF1-11	1SAM250005R1007	0.280
1.5	2.50 ... 4.00	50	50.0	MS116-4.0-HKF1-11	1SAM250005R1008	0.280
2.2	4.00 ... 6.30	50	78.8	MS116-6.3-HKF1-11	1SAM250005R1009	0.280
4.0	6.30 ... 10.0	50	150	MS116-10.0-HKF1-11	1SAM250005R1010	0.280
5.5	8.00 ... 12.0	25	180	MS116-12.0-HKF1-11	1SAM250005R1012	0.280
7.5	10.0 ... 16.0	16	240	MS116-16.0-HKF1-11	1SAM250005R1011	0.280
7.5	16.0 ... 20.0	10	300	MS116-20-HKF1-11	1SAM250005R1013	0.326
11	20.0 ... 25.0	10	375	MS116-25-HKF1-11	1SAM250005R1014	0.326
15	25.0 ... 32.0	10	480	MS116-32-HKF1-11	1SAM250005R1015	0.326

<sup>1)</sup> The data is valid for products, produced after week 34, 2014.

### Main dimensions mm, inches

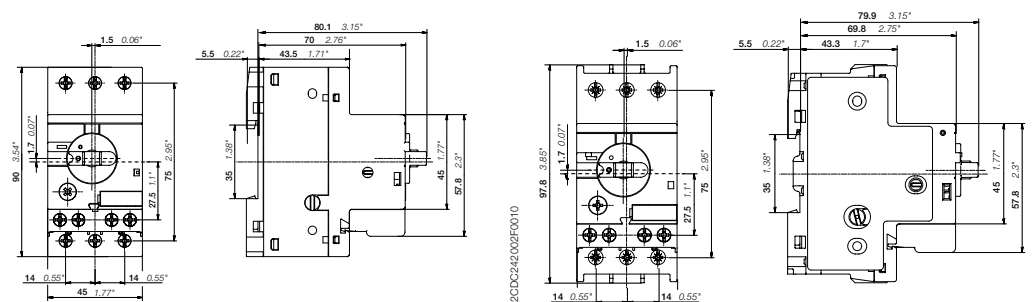

MS116 ≤ 16 A & MS116-HKF1-11 ≤ 16 A

MS116 ≥ 20 A & MS116-HKF1-11 ≥ 20 A

# MS132 manual motor starters

## 0.10 to 32 A – with thermal and electromagnetic protection



1SBC10132F0010

MS132-10



2DCD241001F0011

MS132-32



2DCD24101HF0011

MS132-0.16-HKF1-11



2DCD241015F0011

MS132-32-HKF1-11

### Description

Manual motor starters (MMS) are protection devices for the main circuit. They combine motor control and protection in a single device. MMS are used mainly to switch motors manually ON/OFF and protect them and the installation fuse-less against short-circuit, overload and phase failures. Fuse-less protection with a manual motor starter saves costs, space and ensures a quick reaction under short-circuit condition, by switching off the motor within milliseconds.

MS132 is a compact and powerful range for motor protection up to 15 kW (400 V) / 32 A in width of 45 mm. This type has also a clear and reliable indication of fault in a separate window in the event of short-circuit tripping. Further features are the built-in disconnect function, temperature compensation, trip-free mechanism and a rotary handle with a clear switch position indication. The manual motor starter is suitable for three- and single-phase applications. The handle is lockable to protect against unauthorized changes. Auxiliary contacts, signaling contacts, undervoltage releases, shunt trips, three-phase bus bars, power in-feed blocks.

### Ordering details

Rated operational power 400 V AC-3	Setting range	Short-circuit breaking capacity $I_{cs}$ at 400 V AC	Rated instantaneous short-circuit current setting $I_i$	Type	Order code	Weight (1 pcs)
kW	A	kA	A			kg
0.03	0.10 ... 0.16	100	2.00 <sup>1)</sup>	MS132-0.16	1SAM350000R1001	0.215
0.06	0.16 ... 0.25	100	3.10 <sup>1)</sup>	MS132-0.25	1SAM350000R1002	0.215
0.09	0.25 ... 0.40	100	5.00 <sup>1)</sup>	MS132-0.4	1SAM350000R1003	0.215
0.12	0.40 ... 0.63	100	7.90 <sup>1)</sup>	MS132-0.63	1SAM350000R1004	0.215
0.25	0.63 ... 1.00	100	12.5 <sup>1)</sup>	MS132-1.0	1SAM350000R1005	0.215
0.55	1.00 ... 1.60	100	20.0 <sup>1)</sup>	MS132-1.6	1SAM350000R1006	0.265
0.75	1.60 ... 2.50	100	31.3 <sup>1)</sup>	MS132-2.5	1SAM350000R1007	0.265
1.5	2.50 ... 4.00	100	50.0	MS132-4.0	1SAM350000R1008	0.265
2.2	4.00 ... 6.30	100	78.8	MS132-6.3	1SAM350000R1009	0.265
4.0	6.30 ... 10.0	100	150	MS132-10	1SAM350000R1010	0.265
5.5	8.00 ... 12.0	100	180	MS132-12	1SAM350000R1012	0.310
7.5	10.0 ... 16.0	100	240	MS132-16	1SAM350000R1011	0.310
7.5	16.0 ... 20.0	100	300	MS132-20	1SAM350000R1013	0.310
11	20.0 ... 25.0	50	375	MS132-25	1SAM350000R1014	0.310
15	25.0 ... 32.0	25	480	MS132-32	1SAM350000R1015	0.310
0.03	0.10 ... 0.16	100	2.00 <sup>1)</sup>	MS132-0.16-HKF1-11	1SAM350005R1001	0.231
0.06	0.16 ... 0.25	100	3.10 <sup>1)</sup>	MS132-0.25-HKF1-11	1SAM350005R1002	0.231
0.09	0.25 ... 0.40	100	5.00 <sup>1)</sup>	MS132-0.4-HKF1-11	1SAM350005R1003	0.231
0.12	0.40 ... 0.63	100	7.90 <sup>1)</sup>	MS132-0.63-HKF1-11	1SAM350005R1004	0.231
0.25	0.63 ... 1.00	100	12.5 <sup>1)</sup>	MS132-1.0-HKF1-11	1SAM350005R1005	0.231
0.55	1.00 ... 1.60	100	20.0 <sup>1)</sup>	MS132-1.6-HKF1-11	1SAM350005R1006	0.281
0.75	1.60 ... 2.50	100	31.3 <sup>1)</sup>	MS132-2.5-HKF1-11	1SAM350005R1007	0.281
1.5	2.50 ... 4.00	100	50.0	MS132-4.0-HKF1-11	1SAM350005R1008	0.281
2.2	4.00 ... 6.30	100	78.8	MS132-6.3-HKF1-11	1SAM350005R1009	0.281
4.0	6.30 ... 10.0	100	150	MS132-10.0-HKF1-11	1SAM350005R1010	0.281
5.5	8.00 ... 12.0	100	180	MS132-12.0-HKF1-11	1SAM350005R1012	0.326
7.5	10.0 ... 16.0	100	240	MS132-16.0-HKF1-11	1SAM350005R1011	0.326
7.5	16.0 ... 20.0	100	300	MS132-20-HKF1-11	1SAM350005R1013	0.326
11	20.0 ... 25.0	50	375	MS132-25-HKF1-11	1SAM350005R1014	0.326
15	25.0 ... 32.0	25	480	MS132-32-HKF1-11	1SAM350005R1015	0.326

<sup>1)</sup> The data is valid for products, produced after week 34, 2014.

### Main dimensions mm, inches

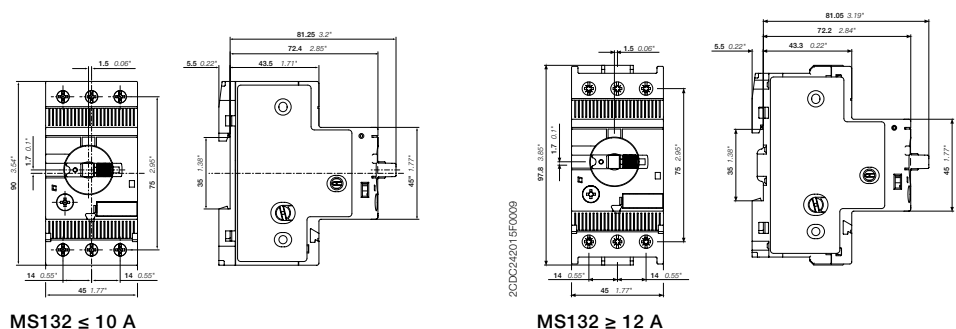

# MO132 manual motor starters magnetic only

## 0.16 to 32 A – with electromagnetic protection

2



2CDC241008F0011

MO132-6.3



2CDC241008F0011

MO132-32

### Description

Manual motor starters magnetic only are electromechanical protection devices for the main circuit. They are used mainly to switch motors manually ON/OFF and protect them fuse-less against short-circuit.

Fuse-less protection with a manual motor starter saves costs, space and ensures a quick reaction under short-circuit condition, by switching off the motor within milliseconds. Fuse-less starter combinations are setup together with contactors and overload relays.

### Ordering details

Rated operational power 400 V AC-3 <sup>1)</sup>	Rated operational current A	Short-circuit breaking capacity $I_{cs}$ at 400 V AC kA	Rated instantaneous short-circuit current setting $I_i$ A	Type	Order code	Weight (1 pcs) kg
0.03	0.16	100	2.00 <sup>2)</sup>	MO132-0.16	1SAM360000R1001	0.215
0.06	0.25	100	3.10 <sup>2)</sup>	MO132-0.25	1SAM360000R1002	0.215
0.09	0.40	100	5.00 <sup>2)</sup>	MO132-0.4	1SAM360000R1003	0.215
0.12	0.63	100	7.90 <sup>2)</sup>	MO132-0.63	1SAM360000R1004	0.215
0.25	1.0	100	12.5 <sup>2)</sup>	MO132-1.0	1SAM360000R1005	0.215
0.55	1.6	100	20.0 <sup>2)</sup>	MO132-1.6	1SAM360000R1006	0.265
0.75	2.5	100	31.3 <sup>2)</sup>	MO132-2.5	1SAM360000R1007	0.265
1.5	4.0	50	50.0	MO132-4.0	1SAM360000R1008	0.265
2.2	6.3	50	78.8	MO132-6.3	1SAM360000R1009	0.265
4.0	10	50	125	MO132-10	1SAM360000R1010	0.265
5.5	12	50	150	MO132-12	1SAM360000R1012	0.310
7.5	16	50	200	MO132-16	1SAM360000R1011	0.310
7.5	20	50	250	MO132-20	1SAM360000R1013	0.310
11	25	50	313	MO132-25	1SAM360000R1014	0.310
15	32	25	400	MO132-32	1SAM360000R1015	0.310

<sup>1)</sup> For overload protection of motors, an appropriate thermal or electronic overload relay must be used

<sup>2)</sup> The data is valid for products, produced after week 34, 2014.

### Main dimensions mm, inches

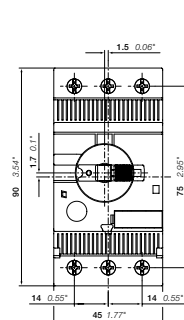

MO132 ≤ 10 A

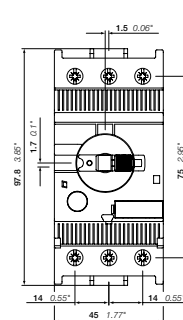
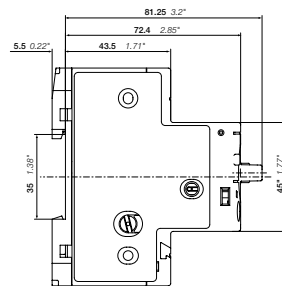

MO132 ≥ 12 A

2CDC242008F0011

2CDC242008F0011

2CDC131062C0201\_3s10

# MS132-T circuit breakers for transformer protection

## 0.10 to 25 A – with thermal and electromagnetic protection



2CDC241002F0014

MS132-10T



2CDC241002F0014

MS132-25T

### Description

Circuit breakers for transformer protection are electro mechanical protection devices specially designed to protect control transformers on the primary side. They allow fuse-less protection against overload and short-circuit, saving space and cost and ensuring a quick reaction under short-circuit condition by switching off the transformer within milliseconds. The short-circuit current setting is fixed to 20 times the operating current to handle the high inrush current generated by transformers. The device allows manual connection and disconnection of the transformer from the mains.

MS132-T is a 45 mm (width) compact and powerful range for transformer protection up to 12.5 kW (400 V) / 25 A. This type has also a clear and reliable indication of fault in a separate window in the event of short-circuit tripping. Further features are the build-in disconnect function, temperature compensation, trip-free mechanism and a rotary handle with a clear switch position indication. The handle is lockable to protect against unauthorized changes. Furthermore it is possible to use the existing MS116/MS132 manual motor starter accessories like auxiliary contacts, signaling contacts, undervoltage releases, shunt trips and power in-feed blocks. Moreover ABB offers special accessories for fast single phase setup.

### Ordering details

Setting range	Short-circuit breaking capacity $I_{cs}$ at 400 V AC	Rated instantaneous short-circuit current setting $I_i$	Type	Order code	Weight (1 pce)
A	kA	A			kg
0.10 ... 0.16	100	3.2	MS132-0.16T	1SAM340000R1001	0.215
0.16 ... 0.25	100	5	MS132-0.25T	1SAM340000R1002	0.215
0.25 ... 0.40	100	8	MS132-0.4T	1SAM340000R1003	0.215
0.40 ... 0.63	100	12.6	MS132-0.63T	1SAM340000R1004	0.215
0.63 ... 1.00	100	20	MS132-1.0T	1SAM340000R1005	0.215
1.00 ... 1.60	100	32	MS132-1.6T	1SAM340000R1006	0.265
1.60 ... 2.50	100	50	MS132-2.5T	1SAM340000R1007	0.265
2.50 ... 4.00	100	80	MS132-4.0T	1SAM340000R1008	0.265
4.00 ... 6.30	100	126	MS132-6.3T	1SAM340000R1009	0.265
6.30 ... 10.0	100	200	MS132-10T	1SAM340000R1010	0.265
8.00 ... 12.0	100	240	MS132-12T	1SAM340000R1012	0.310
10.0 ... 16.0	100	320	MS132-16T	1SAM340000R1011	0.310
16.0 ... 20.0	100	400	MS132-20T	1SAM340000R1013	0.310
20.0 ... 25.0	50	500	MS132-25T	1SAM340000R1014	0.310

Please check for single-phase equipment chapter Main accessories.

### Main dimensions mm, inches

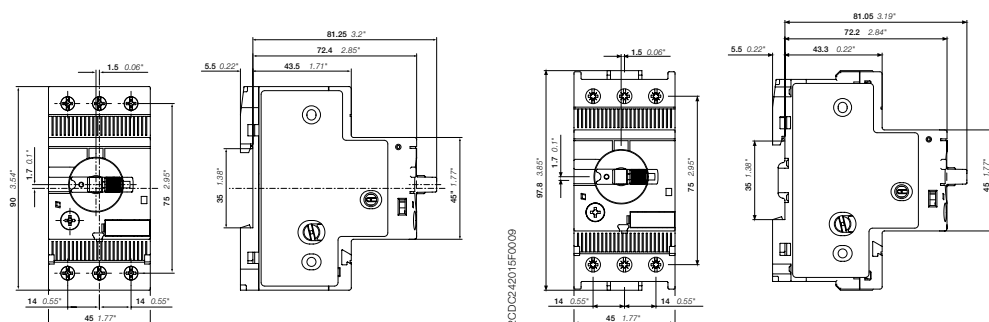

MS132T ≤ 10 A

MS132T ≥ 12 A

2CDC24016F0009

2CDC131062C0201\_4s10

# MS116, MS132, MO132, MS132-T Main accessories

## Manual motor starter with accessories (MS116, MO132)

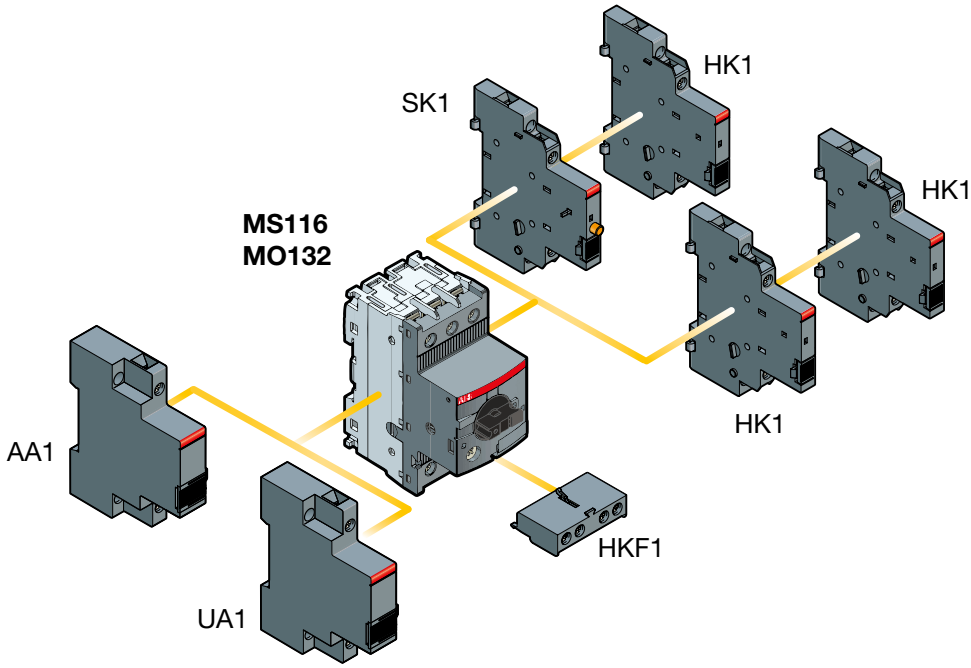

## Manual motor starter with accessories (MS132) and circuit breaker for transformer protection (MS132-T)

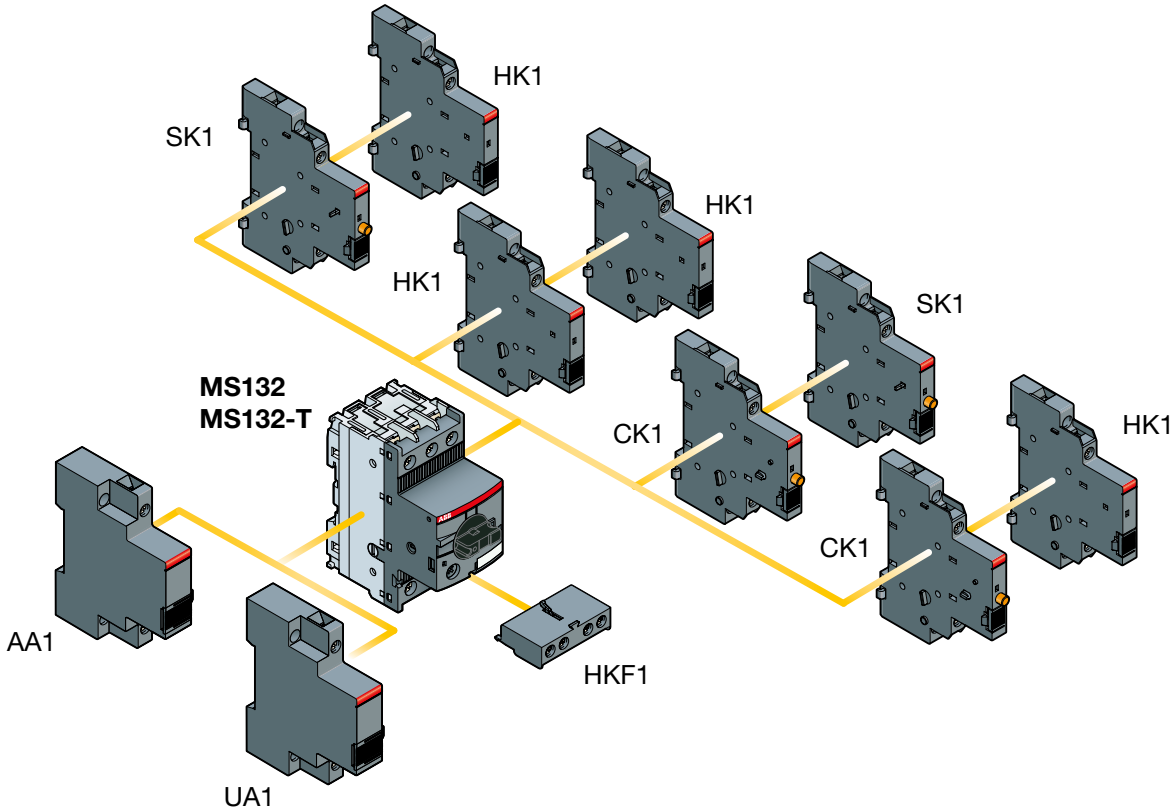



# MS116, MS132, MO132, MS132-T

## Main accessories



HKF1-11

1SBC101209F0014



HK1-11

1SBC101209F0014



SK1-11

1SBC101210F0014



CK1-11

1SBC101286F0014

### Description

MMS and MS132-T can be equipped with auxiliary contacts for lateral/front mounting, signaling contact for lateral mounting, undervoltage release and shunt trips. Two different signaling contacts are available. The accessories can be fitted wiring free and without tools. A variety of combinations is possible as required for the application. The auxiliary contacts change position with the main contacts. The signaling contact SK signals tripping regardless if it was caused by short-circuit or overload. The signaling contact CK signals tripping in case it was caused by short-circuit. Undervoltage release are used for remote tripping of the manual motor starter especially for emergency stop circuits. Shunt trips release the MMS used for remote tripping.

### Ordering details

Suitable for	Auxiliary contacts N.O.	Auxiliary contacts N.C.	Description	Type	Order code	Pkg qty	Weight (1 pce)
						pce	kg
<b>Auxiliary contacts – mountable on the front</b>							
MS116, MS132,	1	1		HKF1-11	1SAM201901R1001	10	0.015
MO132, MS132-T	2	0		HKF1-20	1SAM201901R1002	10	0.015
<b>Auxiliary contacts – mountable on the right</b>							
MS116, MS132,	1	1	max. 2 pieces	HK1-11	1SAM201902R1001	2	0.035
MO132, MS132-T	2	0	max. 2 pieces	HK1-20	1SAM201902R1002	2	0.035
	0	2	max. 2 pieces	HK1-02	1SAM201902R1003	2	0.035
	2	0	with lead contacts	HK1-20L	1SAM201902R1004	2	0.035
<b>Signaling contacts – mountable on the right</b>							
MS116, MS132,	1	1	for tripped alarm, max. 2 pieces	SK1-11	1SAM201903R1001	2	0.035
MO132, MS132-T	2	0	for tripped alarm, max. 2 pieces	SK1-20	1SAM201903R1002	2	0.035
	0	2	for tripped alarm, max. 2 pieces	SK1-02	1SAM201903R1003	2	0.035
MS132, MS132-T	1	1	for short-circuit alarm, max. 2 pieces	CK1-11	1SAM301901R1001	2	0.035
	2	0	for short-circuit alarm, max. 2 pieces	CK1-20	1SAM301901R1002	2	0.035
	0	2	for short-circuit alarm, max. 2 pieces	CK1-02	1SAM301901R1003	2	0.035

### Main dimensions mm, inches

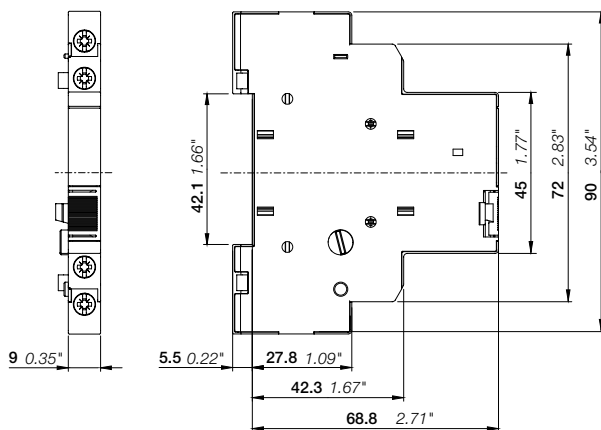

HK1

2DCD242001F0012

# MS116, MS132, MO132, MS132-T

## Main accessories

2



AA1-24

1SBC101211F0014



UA1-24

1SBC101212F0014

### Ordering details

Suitable for	Rated control supply voltage		Type	Order code	Pkg qty	Weight (1 pce)
	50 Hz V AC	60 Hz V AC				
<b>Shunt trips – mountable on the left</b>						
MS116, MS132, MO132, MS132-T	20 ... 24	20 ... 24	AA1-24	1SAM201910R1001	1	0.100
	110	110	AA1-110	1SAM201910R1002	1	0.100
	200 ... 240	200 ... 240	AA1-230	1SAM201910R1003	1	0.100
	350 ... 415	350 ... 415	AA1-400	1SAM201910R1004	1	0.100
<b>Undervoltage releases – mountable on the left</b>						
MS116, MS132, MO132, MS132-T	20	24	UA1-20	1SAM201904R1010	1	0.100
	24	-	UA1-24	1SAM201904R1001	1	0.100
	48	-	UA1-48	1SAM201904R1002	1	0.100
	60	-	UA1-60	1SAM201904R1003	1	0.100
	110	120	UA1-110	1SAM201904R1004	1	0.100
	-	208	UA1-208	1SAM201904R1008	1	0.100
	230	240	UA1-230	1SAM201904R1005	1	0.100
	400	-	UA1-400	1SAM201904R1006	1	0.100
	415	480	UA1-415	1SAM201904R1007	1	0.100
	-	575	UA1-575	1SAM201904R1009	1	0.100

### Main dimensions mm, inches

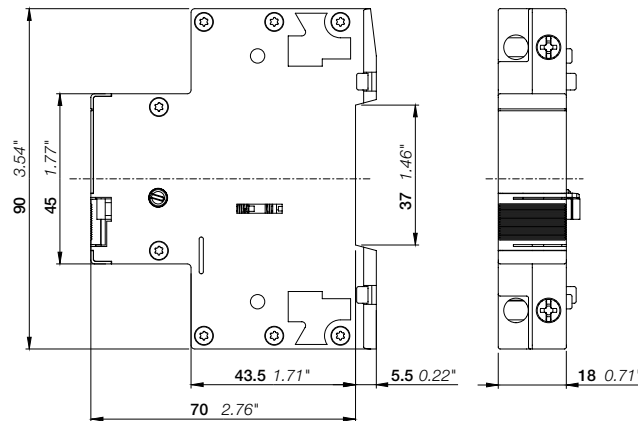

AA1, UA1

2DCD242002F0012

2CDC131050C0201\_3en

# MS116, MS132, MO132

## Main accessories

### Manual motor starter with three-phase busbar systems

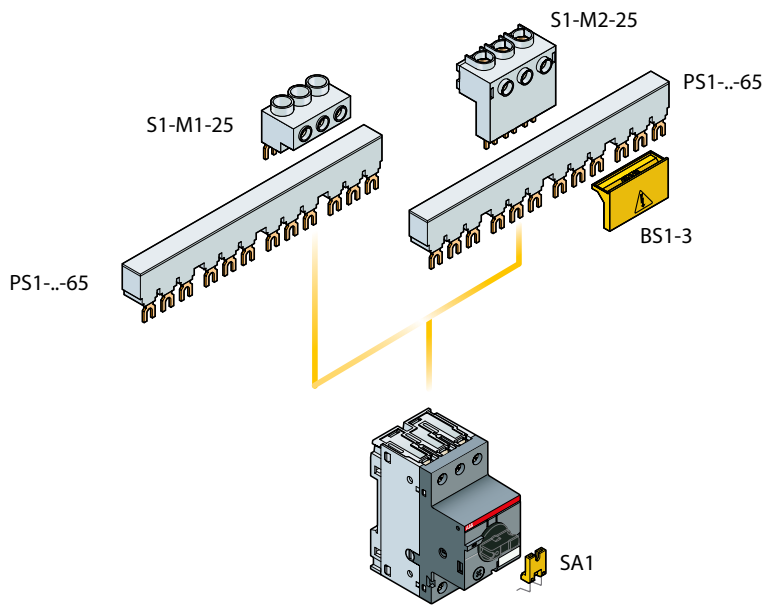

Three-phase busbar up to 65 A

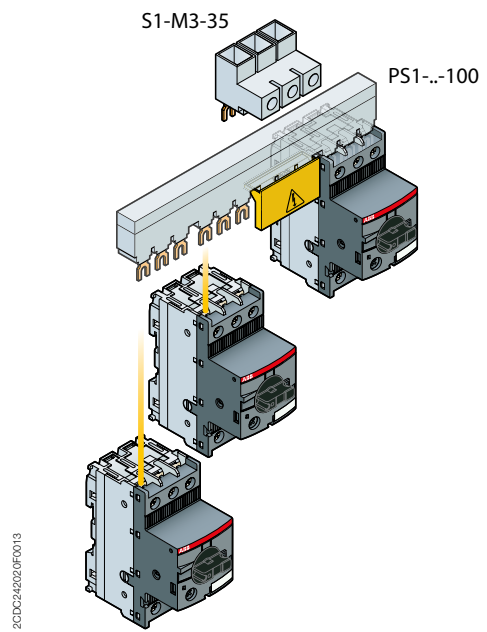

Three-phase busbar up to 100 A

# MS116, MS132, MO132, MS132-T

## Main accessories

2

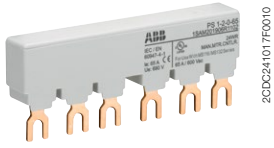

PS1-2-0-65

2CDC241017F0010

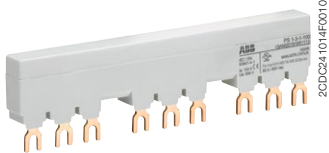

PS1-3-1-100

2CDC241014F0010

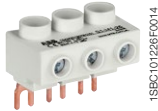

S1-M1-25

1SBC101226F0014



S1-M2-25

1SBC101266F0014



SA2

2CDC241023F0013



SA1

SK0108B91



PB1-1-32

2CDC241004R0014



S1-PB1-25

2CDC241005S0014

### Description

Three-phase busbars ensure a quick and safe connection and are therefore a cost effective solution. A variety of different three-phase busbars up to 100 A are in the assortment. Between 2 and 5 manual motor starters with none, one or two lateral auxiliary contacts can be connected. Different three-phase feeder terminals are available according to the application.

Phase connecting links and phase power infeed blocks are also available for single-phase applications.

### Ordering details

Suitable for	Rated operational current	Number of MMS	Number of lateral aux.	Type	Order code	Pkg qty	Weight (1 pce)
	A					pce	kg
<b>Three-phase busbars</b>							
MS116, MS132, MO132	65	2	0	PS1-2-0-65	1SAM201906R1102	10	0.034
	65	3	0	PS1-3-0-65	1SAM201906R1103	10	0.055
	65	4	0	PS1-4-0-65	1SAM201906R1104	10	0.077
	65	5	0	PS1-5-0-65	1SAM201906R1105	10	0.098
	65	2	1	PS1-2-1-65	1SAM201906R1112	10	0.036
	65	3	1	PS1-3-1-65	1SAM201906R1113	10	0.060
	65	4	1	PS1-4-1-65	1SAM201906R1114	10	0.087
	65	5	1	PS1-5-1-65	1SAM201906R1115	10	0.108
	65	2	2	PS1-2-2-65	1SAM201906R1122	10	0.040
	65	3	2	PS1-3-2-65	1SAM201906R1123	10	0.067
	65	4	2	PS1-4-2-65	1SAM201906R1124	10	0.095
	65	5	2	PS1-5-2-65	1SAM201906R1125	10	0.122
MS116, MS132, MO132	100	3	0	PS1-3-0-100	1SAM201916R1103	10	0.084
	100	4	0	PS1-4-0-100	1SAM201916R1104	10	0.117
	100	5	0	PS1-5-0-100	1SAM201916R1105	10	0.154
	100	3	1	PS1-3-1-100	1SAM201916R1113	10	0.094
	100	4	1	PS1-4-1-100	1SAM201916R1114	10	0.134
	100	5	1	PS1-5-1-100	1SAM201916R1115	10	0.172
	100	3	2	PS1-3-2-100	1SAM201916R1123	10	0.105

Suitable for	Rated operational current	Rated cross section	Mounting form	Type	Order code	Pkg qty	Weight (1 pce)
	A	mm <sup>2</sup>				pce	kg
<b>Three-phase feeder terminals</b>							
MS116, MS132, MO132	65	25	Flat	S1-M1-25	1SAM201907R1101	10	0.038
	65	25	High	S1-M2-25	1SAM201907R1102	10	0.051
	65	25	UL type E and IEC	S1-M3-25	1SAM201907R1103	10	0.042
	100	35	UL type E and IEC	S1-M3-35	1SAM201913R1103	10	0.060

Suitable for	Description	Type	Order code	Pkg qty	Weight (1 pce)
				pce	kg
MS116, MS132, MO132	Protection cover for busbars	BS1-3	1SAM201908R1001	50	0.003
MS116, MS132, MO132, MS132-T	Screw fixing kit	FS116	1SAM201909R1001	1	0.020
	Padlock + two keys	SA2	GJF1101903R0002	10	0.020
MS116	Lock handle	SA1	GJF1101903R0001	10	0.003
	Lock handle box SA1/SA2	SA3	GJF1101903R0003	10	0.050

### Accessories for single-phase connection

MS116, MS132, MO132, MS132-T	Phase connecting link	PB1-1-32	1SAM201914R1001	1	0.009
	Phase power infeed block	S1-PB1-25	1SAM201914R1002	1	0.013

# MS116, MS132, MO132

## Main accessories



2CDC241004F0010

IB132-Y



2CDC241003F0010

IB132-G



2CDC241002F0010

DMS132-Y



2CDC241001F0010

DMS132-G

### Description

IB132 are IP65 enclosures for single MMS installation. Additional mounting of auxiliary and signaling contacts, shunt trips and undervoltage release is possible. The handle is lockable in OFF position. For detailed specification see installation instruction.

DMS132 are IP65 door mounting kits for MMS installation in any enclosure. Additional mounting of auxiliary, signaling, shunt trips and undervoltage release is possible. The handle is lockable in OFF position. For detailed specification see installation instruction.

### Ordering details

Suitable for	Description	Color	Type	Order code	Pkg qty	Weight (1 pce)
					pce	kg
<b>IP65 enclosures (UL: Type 12)</b>						
MS116, MS132, MO132	Padlockable max. 3 padlocks with bail diameter 4 ... 6.5 mm	Yellow/red	IB132-Y	1SAM201911R1011	1	0.370
		Grey/black	IB132-G	1SAM201911R1010	1	0.370
<b>IP65 door mounting kits (UL: Type 12)</b>						
MS116, MS132, MO132	Padlockable max. 3 padlocks with bail diameter 4 ... 6.5 mm	Yellow/red	DMS132-Y	1SAM201912R1011	1	0.170
		Grey/black	DMS132-G	1SAM201912R1010	1	0.170

Indication I-O-T and ON-OFF-T

Please check for further equipment chapter General accessories.

### Main dimensions mm, inches

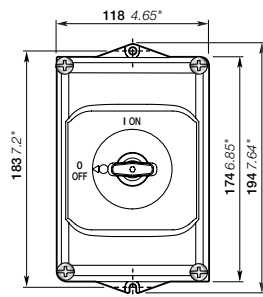

IB132

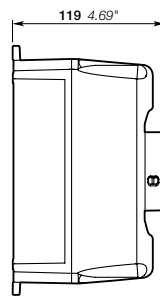

2CDC242011F0011

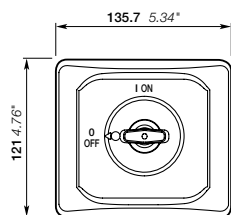

DMS132

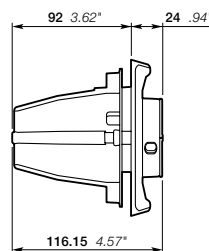

2CDC242012F0011

# MS450, MS495, MS497 manual motor starters

## 22 to 100 A – with thermal and electromagnetic protection

2



2CDD241004F0009

MS450-40



1SBC101184F0014

MS495-40



2CDD241020F0011

MS497-100

### Description

Manual motor starters (MMS) are protection devices for the main circuit. They combine motor control and protection in a single device. MMS are used mainly to switch motors manually ON/OFF and protect them and the installation fuse-less against short-circuit, overload and phase failures. Fuse-less protection with a manual motor starter saves costs, space and ensures a quick reaction under short-circuit condition, by switching off the motor within milliseconds.

Further features are the build-in disconnect function, temperature compensation, trip-free mechanism and a rotary handle with a clear switch position indication. The manual motor starter is suitable for three- and single-phase applications. The handle is lockable to protect against unauthorized changes. Auxiliary contacts, signalling contacts, undervoltage releases, shunt trips, three-phase busbars, power in-feed blocks are available as accessory.

### Ordering details

Rated operational power 400 V AC-3 kW	Setting range A	Short-circuit breaking capacity $I_{cs}$ at 400 V AC kA	Rated instantaneous short-circuit current setting $I_i$ A	Type	Order code	Weight (1 pcs) kg
<b>MS450 manual motor starters</b>						
18.5	28.0 ... 40.0	25	520.00	MS450-40	1SAM450000R1005	1.047
22	36.0 ... 45.0	25	585.00	MS450-45	1SAM450000R1006	1.039
22	40.0 ... 50.0	25	650.00	MS450-50	1SAM450000R1007	1.027
<b>MS495 manual motor starters</b>						
30	45.0 ... 63.0	25	819.00	MS495-63	1SAM550000R1007	2.247
37	57.0 ... 75.0	25	975.00	MS495-75	1SAM550000R1008	2.253
45	70.0 ... 90.0	25	1170.00	MS495-90	1SAM550000R1009	2.280
55	80.0 ... 100.0	25	1235.00	MS495-100	1SAM550000R1010	2.295
<b>MS497 manual motor starters</b>						
15	22.0 ... 32.0	50	416.00	MS497-32	1SAM580000R1004	2.222
18.5	28.0 ... 40.0	50	520.00	MS497-40	1SAM580000R1005	2.203
22	36.0 ... 50.0	50	650.00	MS497-50	1SAM580000R1006	2.230
30	45.0 ... 63.0	50	819.00	MS497-63	1SAM580000R1007	2.255
37	57.0 ... 75.0	50	975.00	MS497-75	1SAM580000R1008	2.266
45	70.0 ... 90.0	50	1170.00	MS497-90	1SAM580000R1009	2.268
55	80.0 ... 100.0	50	1235.00	MS497-100	1SAM580000R1010	2.275

### Main dimensions mm, inches

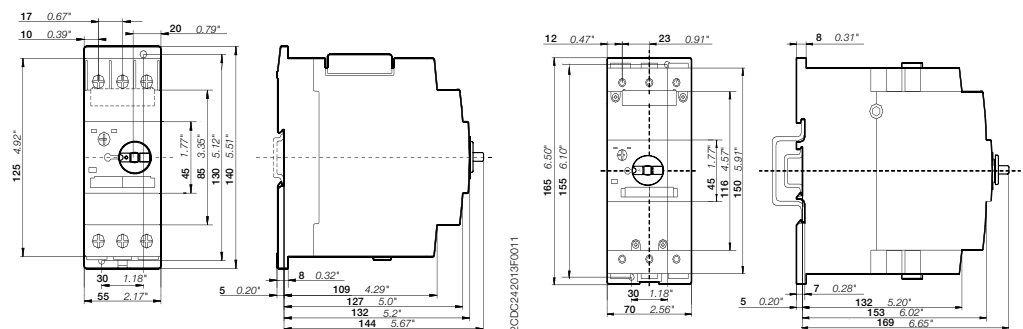

MS450

MS495, MS497

# MO450, MO495, MO496 manual motor starters magnetic only 32 to 100 A – with electromagnetic protection



ST02601

MO450-40



ST02601

MO495-75



2CDC24021F0011

MO496-100

## Description

The manual motor starter magnetic only is used to manually switch on and off motors and to protect them reliably and without the need for a fuse from short-circuits.

Further features are the build-in disconnect function, trip-free mechanism and a rotary handle with a clear switch position indication. The manual motor starter magnetic only is suitable for three- and single-phase applications. The handle is lockable to protect against unauthorized changes. Auxiliary contacts, signalling contacts, undervoltage releases, shunt trips, three-phase busbars, power in-feed blocks are available as accessory.

## Ordering details

Rated operational power 400 V AC-3 <sup>1)</sup> kW	Rated operational current A	Short-circuit breaking capacity I <sub>cs</sub> at 400 V AC kA	Rated instantaneous short-circuit current setting I <sub>n</sub> A	Type	Order code	Weight (1 pcs) kg
<b>MO450 manual motor starter magnetic only</b>						
18.5	40	25	520.00	MO450-40	1SAM460000R1005	1.033
22	45	25	585.00	MO450-45	1SAM460000R1006	1.040
22	60	25	650.00	MO450-50	1SAM460000R1007	1.019
<b>MO495 manual motor starter magnetic only</b>						
30	63	25	819.00	MO495-63	1SAM560000R1007	2.244
37	75	25	975.00	MO495-75	1SAM560000R1008	2.247
45	90	25	1170.00	MO495-90	1SAM560000R1009	2.269
55	100	25	1235.00	MO495-100	1SAM560000R1010	2.292
<b>MO496 manual motor starter magnetic only</b>						
15	32	50	416.00	MO496-32	1SAM590000R1004	2.208
18.5	40	50	520.00	MO496-40	1SAM590000R1005	2.218
22	50	50	650.00	MO496-50	1SAM590000R1006	2.218
30	63	50	819.00	MO496-63	1SAM590000R1007	2.248
37	75	50	975.00	MO496-75	1SAM590000R1008	2.278
45	90	50	1170.00	MO496-90	1SAM590000R1009	2.266
55	100	50	1235.00	MO496-100	1SAM590000R1010	2.293

<sup>1)</sup> For overload protection of motors, an appropriate thermal or electronic overload relay must be used

## Main dimensions mm, inches

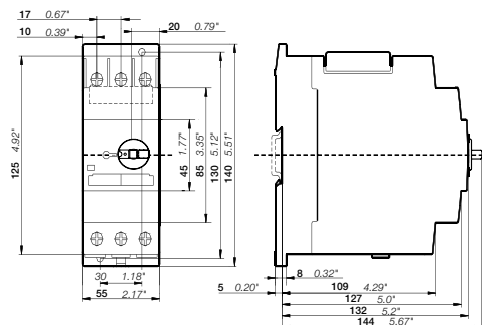

MO450

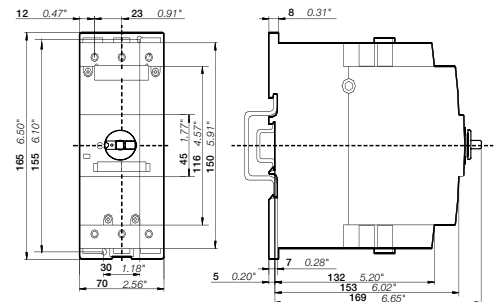

MO495, MO496

# MS45x, MS49x, MO45x, MO49x manual motor starters

## Main accessories

### Manual motor starters MS45x and MS49x with accessories

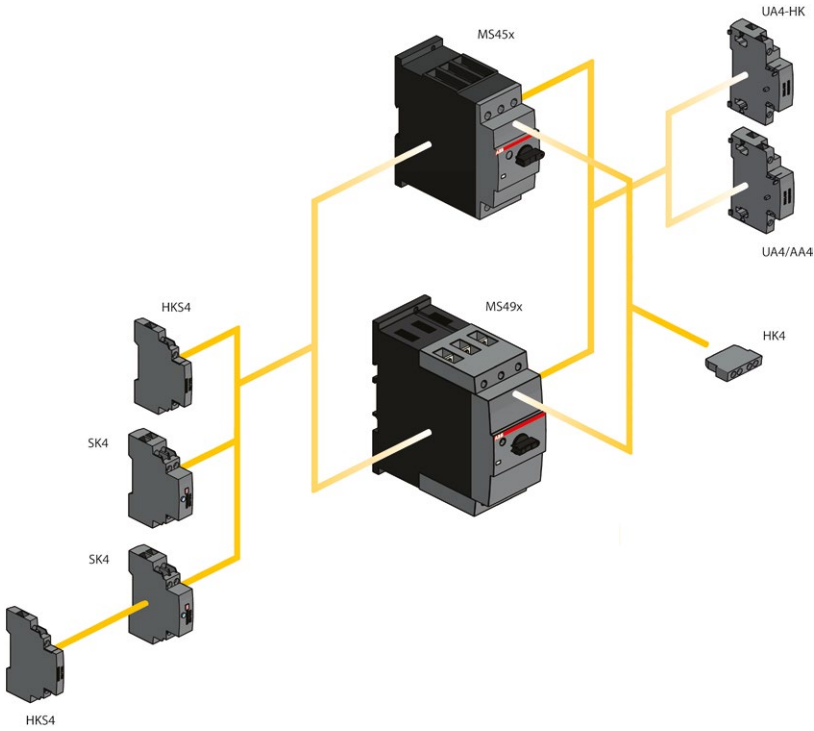

2CDC24025F0011

### Manual motor starters MO45x and MO49x with accessories

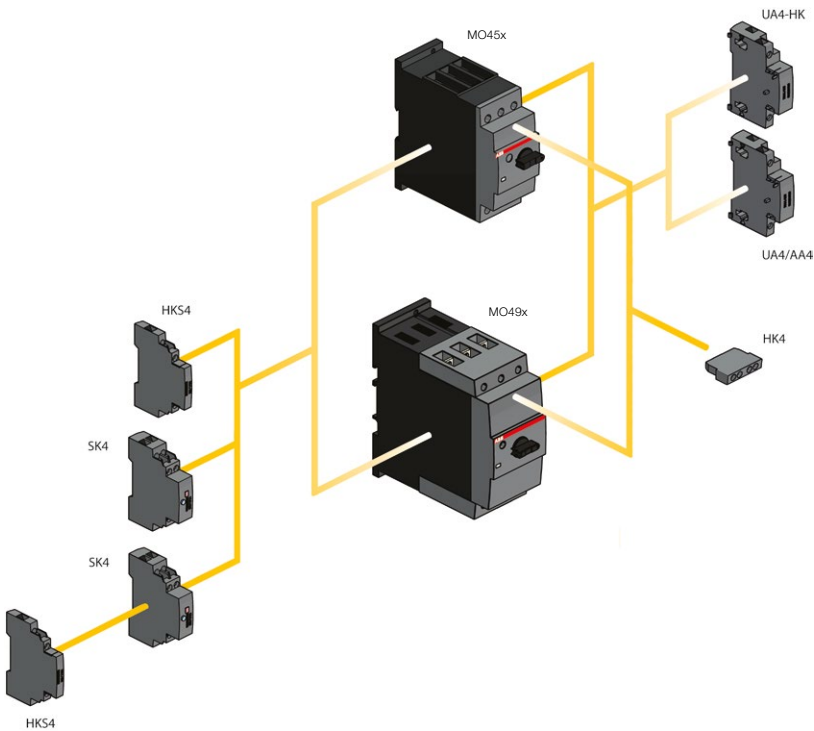

2CDC24025F0011



# MS45x, MS49x, MO45x, MO49x manual motor starters

## Main accessories



HK4-11

2DCD241028F0011



HKS4-20

2DCD241028F0011



SK4-11

2DCD241028F0011



AA4-24

2DCD241028F0011



UA4-110

2DCD241028F0011

### Description

Manual motor starters can be equipped with auxiliary contacts for lateral/front mounting, signalling contact for lateral mounting, undervoltage release and shunt trips. The accessories can be fitted wiring free and without tools. A variety of combinations is possible as required for the application. The auxiliary contacts change position with the main contacts. Undervoltage release are used for remote tripping of the manual motor starter especially for emergency stop circuits. Shunt trips release the MMS used for remote tripping.

### Ordering details

Suitable for	Auxiliary con- tacts N.O.	Auxiliary con- tacts N.C.	Description	Type	Order code	Pkg qty	Weight (1 pcs) kg
<b>Auxiliary contacts – mountable on the front</b>							
MS45x,	1	1	Changeover	HK4-11	1SAM401901R1001	10	0.017
MS49x, MO45x, MO49x				HK4-W	1SAM401901R1002	10	0.015
<b>Auxiliary contacts – mountable on the left</b>							
MS45x,	1	1	Max. 1 piece	HKS4-11	1SAM401902R1001	2	0.045
MS49x,	2	0	Max. 1 piece	HKS4-20	1SAM401902R1002	2	0.045
MO45x, MO49x	0	2	Max. 1 piece	HKS4-02	1SAM401902R1003	2	0.045
<b>Signalling contacts – mountable on the left</b>							
MS45x, MS49x, MO45x, MO49x	2	2	Separate signalling acc. UL508E 1 N.O. + 1 N.C. for short circuit alarm and 1 N.O. + 1 N.C. for tripped alarm, max. 1x SK4-11 + 1 x HKS4-xx	SK4-11	1SAM401904R1001	1	0.093

Suitable for	Rated control supply voltage	Frequency	Type	Order code	Pkg qty	Weight (1 pcs) kg
	V	Hz				kg
<b>Shunt trip units – mountable on the right</b>						
MS45x,	20 ... 24	50/60	AA4-24	1SAM401907R1001	1	0.135
MS49x,	90 ... 110	50/60	AA4-110	1SAM401907R1002	1	0.135
MO45x,	200 ... 240	50/60	AA4-230	1SAM401907R1003	1	0.128
MO49x	350 ... 415	50/60	AA4-400	1SAM401907R1004	1	0.125
<b>Undervoltage releases – mountable on the right</b>						
MS45x,	24	50/60	UA4-24	1SAM401905R1004	1	0.134
MS49x,	110/120	50/60	UA4-110	1SAM401905R1001	1	0.134
MO45x,	230/240	50/60	UA4-230	1SAM401905R1002	1	0.131
MO49x	400/440	50/60	UA4-400	1SAM401905R1003	1	0.129
	230/240	50/60	UA4-HK-230	1SAM401906R1001	1	0.140
	400/440	50/60	UA4-HK-400	1SAM401906R1002	1	0.137

# MS45x, MS49x, MO45x, MO49x manual motor starters

## Main accessories

2

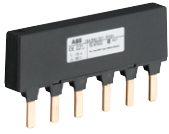

PS4-2-0

2CDC241008F0012

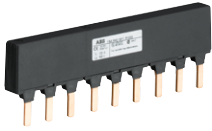

PS4-3-0

2CDC241004F0012

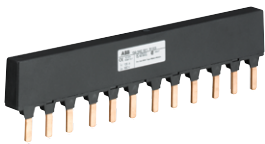

PS4-4-0

2CDC241005F0012



SA2

2CDC241023F0013

### Description

Three-phase busbars ensure a quick and safe connection and are therefore a cost-effective solution. A variety of different three-phase busbars up to 108 A are in the assortment. Between 2 and 4 manual motor starters with none or two lateral auxiliary contacts can be connected.

### Ordering details

Suitable for	Rated operational current A	Number of MMS	Number of lateral aux.	Type	Order code	Pkg qty	Weight (1 pcs) kg
--------------	--------------------------------	------------------	---------------------------	------	------------	------------	-------------------------

#### Three-phase busbars

MS450, MO450	108 A	2	0	PS4-2-0	1SAM401911R1001	5	0.134
	108 A	3	0	PS4-3-0	1SAM401911R1002	5	0.206
	108 A	4	0	PS4-4-0	1SAM401911R1003	5	0.280
	108 A	2	1	PS4-2-2	1SAM401911R1004	5	0.148
	108 A	3	1	PS4-3-2	1SAM401911R1005	5	0.250
	108 A	4	1	PS4-4-2	1SAM401911R1006	5	0.362

Suitable for	Rated operational current A	Rated cross section mm <sup>2</sup>	Mounting form	Type	Order code	Pkg qty	Weight (1 pcs) kg
--------------	--------------------------------	---	------------------	------	------------	------------	-------------------------

#### Three-phase feeder terminals

MS450, MO450	108 A	25	Flat	S4-M1	1SAM401911R1007	2	0.106
-----------------	-------	----	------	-------	-----------------	---	-------

Suitable for	Description	Type	Order code	Pkg qty	Weight (1 pcs) kg
MS450, MO450	Protection cover for busbar	BS4-3	1SAM401911R1008	10	0.001
	Disconnecter module	TB450	1SAM401910R1001	1	0.315
	Terminal shroud	KA450	1SAM401908R1001	1	0.154
MS495, MS497, MO495, MO496	Terminal shroud	KA495	1SAM501901R1001	10	0.018
	Terminal shroud	KA495C <sup>1)</sup>	1SAM501902R1001	10	0.038
	Terminal insulation barrier for UL508E	DX495	1SAM401912R1001	1	0.154
MS450, MS495, MS497, MO450, MO495, MO496	Padlock + two keys	SA2	GJF1101903R0002	10	0.020

<sup>1)</sup> Is plugged onto the housing after removing the box terminals, if using cable lugs.

# MS325 manual motor starters

## 0.10 to 25 A – with thermal and electromagnetic protection



MS325-16

### Description

Manual motor starters (MMS) are protection devices for the main circuit. They combine motor control and protection in a single device. MMS are used mainly to switch motors manually ON/OFF and protect them and the installation fuse-less against short-circuit, overload and phase failures. Fuse-less protection with a manual motor starter saves costs, space and ensures a quick reaction under short-circuit condition, by switching off the motor within milliseconds.

MS325 is a compact and powerful range for motor protection up to 12.5 kW (400 V) / 25 A in width of 54 mm with modular DIN rail design. Further features are the built-in disconnect function, temperature compensation, trip-free mechanism and a rotary handle with a clear switch position indication. The manual motor starters are suitable for three- and single-phase applications. Auxiliary contacts, signalling contacts, undervoltage releases, shunt trips, three-phase busbars, power in-feed blocks are available as accessories.

### Ordering details

Rated operational power 400 V AC-3	Setting range	Short-circuit breaking capacity $I_{cs}$ at 400 V AC	Rated instantaneous short-circuit current setting $I_i$	Type	Order code	Weight (1 pce)
kW	A	kA	A			kg
0.03	0.10 ... 0.16	100	1.56	MS325-0.16	1SAM150000R1001	0.280
0.06	0.16 ... 0.25	100	2.44	MS325-0.25	1SAM150000R1002	0.280
0.09	0.25 ... 0.40	100	3.9	MS325-0.4	1SAM150000R1003	0.280
0.12	0.40 ... 0.63	100	6.14	MS325-0.63	1SAM150000R1004	0.280
0.25	0.63 ... 1.00	100	11.5	MS325-1	1SAM150000R1005	0.310
0.55	1.00 ... 1.60	100	18.4	MS325-1.6	1SAM150000R1006	0.340
0.75	1.60 ... 2.50	100	28.75	MS325-2.5	1SAM150000R1007	0.340
1.5	2.50 ... 4.00	100	50	MS325-4	1SAM150000R1008	0.340
2.2	4.00 ... 6.30	100	78.75	MS325-6.3	1SAM150000R1009	0.340
4.0	6.30 ... 9.00	100	135	MS325-9	1SAM150000R1010	0.340
5.5	9.00 ... 12.5	75	180	MS325-12.5	1SAM150000R1011	0.340
7.5	12.5 ... 16.0	60	240	MS325-16	1SAM150000R1012	0.340
9.0	16.0 ... 20.0	55	300	MS325-20	1SAM150000R1013	0.340
12.5	20.0 ... 25.0	50	375	MS325-25	1SAM150000R1014	0.340
0.03	0.10 ... 0.16	100	1.56	MS325-0.16-HKF11	1SAM150005R0001	0.300
0.06	0.16 ... 0.25	100	2.44	MS325-0.25-HKF11	1SAM150005R0002	0.300
0.09	0.25 ... 0.40	100	3.9	MS325-0.4-HKF11	1SAM150005R0003	0.300
0.12	0.40 ... 0.63	100	6.14	MS325-0.63-HKF11	1SAM150005R0004	0.300
0.25	0.63 ... 1.00	100	11.5	MS325-1-HKF11	1SAM150005R0005	0.330
0.55	1.00 ... 1.60	100	18.4	MS325-1.6-HKF11	1SAM150005R0006	0.360
0.75	1.60 ... 2.50	100	28.75	MS325-2.5-HKF11	1SAM150005R0007	0.360
1.5	2.50 ... 4.00	100	50	MS325-4-HKF11	1SAM150005R0008	0.360
2.2	4.00 ... 6.30	100	78.75	MS325-6.3-HKF11	1SAM150005R0009	0.360
4.0	6.30 ... 10.0	100	135	MS325-9-HKF11	1SAM150005R0010	0.360
5.5	8.00 ... 12.0	75	180	MS325-12.5-HKF11	1SAM150005R0011	0.360
7.5	10.0 ... 16.0	60	240	MS325-16-HKF11	1SAM150005R0012	0.360
9.0	16.0 ... 20.0	55	300	MS325-20-HKF11	1SAM150005R0013	0.360
12.5	20.0 ... 25.0	50	375	MS325-25-HKF11	1SAM150005R0014	0.360

### Main dimensions mm, inches

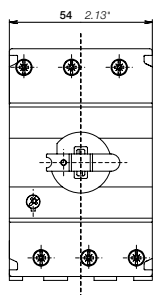

MS325

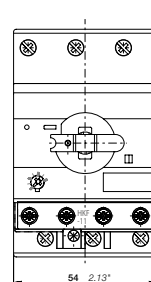
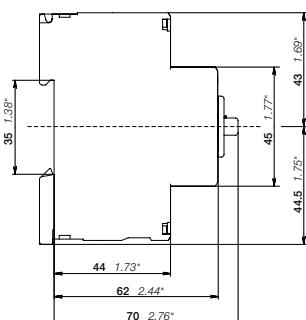

MS325 + HKF11

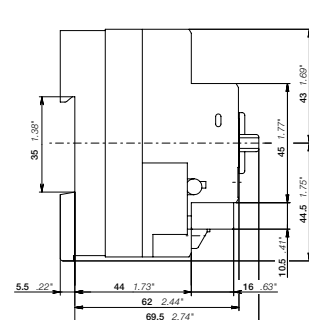

# MO325 manual motor starters magnetic only 0.4 to 25 A – with electromagnetic protection

2



2CDC241008F0009

MO325-16

## Description

The MO325 manual motor starters magnetic only are 54 mm width devices with modular DIN rail design. These devices are used to manually switch on and off motors and to protect them reliably and without the need for a fuse from short-circuits.

Further features are the build-in disconnect function, trip-free mechanism and a rotary handle with a clear switch position indication. The manual motor starter magnetic only is suitable for three- and single-phase applications. Auxiliary contacts, signalling contacts, undervoltage releases, shunt trips, three-phase busbars, power in-feed blocks are available as accessory.

## Ordering details

Rated operational power 400 V AC-3 <sup>1)</sup>	Rated operational current	Short-circuit breaking capacity $I_{cs}$ at 400 V AC	Rated instantaneous short-circuit current setting $I_i$	Type	Order code	Weight (1 pce)
kW	A	kA	A			kg
0.09	0.40	100	3.9	MO325-0.4	1SAM160000R1003	0.280
0.12	0.63	100	6.14	MO325-0.63	1SAM160000R1004	0.280
0.25	1.0	100	11.5	MO325-1	1SAM160000R1005	0.310
0.55	1.6	100	18.4	MO325-1.6	1SAM160000R1006	0.340
0.75	2.5	100	28.75	MO325-2.5	1SAM160000R1007	0.340
1.5	4.0	100	50	MO325-4	1SAM160000R1008	0.340
2.2	6.3	100	78.75	MO325-6.3	1SAM160000R1009	0.340
4.0	9.0	100	135	MO325-9	1SAM160000R1010	0.340
5.5	12.5	75	180	MO325-12.5	1SAM160000R1011	0.340
7.5	16	60	240	MO325-16	1SAM160000R1012	0.340
9.0	20	55	300	MO325-20	1SAM160000R1013	0.340
12.5	25	50	375	MO325-25	1SAM160000R1014	0.340

<sup>1)</sup> For overload protection of motors, an appropriate thermal or electronic overload relay must be used

## Main dimensions mm, inches

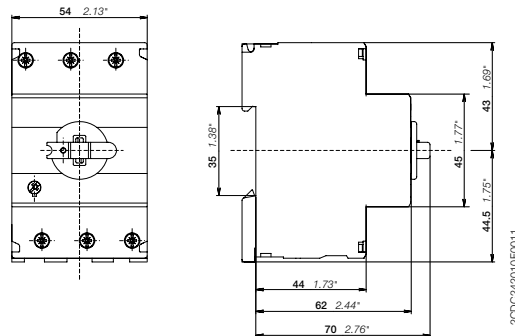

MO325

2CDC242010F0011

2CDC131064C0201\_2s5

# MS325, MO325 manual motor starters

## Main accessories



SA1

2CDC241014R0010



SA2

2CDC241023R0013



SA3

SK0110891

### Description

Three-phase busbars ensure a quick and safe connection and are therefore a cost effective solution. A variety of different three-phase busbars up to 63 A are in the assortment. Between 2 and 5 manual motor starters with none, one or two lateral auxiliary contacts can be connected. Different three-phase feeder terminals are available according to the application.

### Ordering details

Suitable for	Rated operational current A	Number of MMS	Number of lateral aux.	Type	Order code	Pkg qty	Weight (1 pce) kg
<b>Three-phase busbars</b>							
MS325, MO325	63	2	0	PS3-2-0	1SAM101937R0012	10	0.038
	63	3	0	PS3-3-0	1SAM101937R0013	10	0.062
	63	4	0	PS3-4-0	1SAM101937R0014	10	0.087
	63	5	0	PS3-5-0	1SAM101937R0015	10	0.115
	63	6	0	PS3-6-0	1SAM101937R0016	10	0.137
	63	2	1	PS3-2-1	1SAM101937R0022	10	0.040
	63	3	1	PS3-3-1	1SAM101937R0023	10	0.068
	63	4	1	PS3-4-1	1SAM101937R0024	10	0.097
	63	5	1	PS3-5-1	1SAM101937R0025	10	0.126
	63	3	2	PS3-2-2	1SAM101937R0032	10	0.043
	63	4	2	PS3-4-2	1SAM101937R0034	10	0.106

Suitable for	Rated operational current A	Rated cross section mm <sup>2</sup>	Mounting form	Type	Order code	Pkg qty	Weight (1 pce) kg
<b>Three-phase feeder terminals</b>							
MS325, MO325	63	25	Flat	S3-M1	1SAM101938R0001	10	0.041
	63	25	High	S3-M2	1SAM101938R0002	10	0.053
	63	35	UL type E and IEC	S3-M3	1SAM101938R0004	10	0.050

Suitable for	Description	Type	Order code	Pkg qty	Weight (1 pce) kg
MS325, MO325	Protection cover for busbars	BS3-3	1SAM101938R0003	50	0.001
	Lock handle	SA1	GJF1101903R0001	10	0.003
	Padlock + two keys	SA2	GJF1101903R0002	10	0.020
	Lock handle box SA1/SA2	SA3	GJF1101903R0003	10	0.050

# MS325, MO325 manual motor starters

## Main accessories

2

### Description

MS325 and MO325 manual motor starters can be equipped with auxiliary contacts for lateral/front mounting, signalling contact for lateral mounting, undervoltage release and shunt trips. A variety of combinations is possible as required for the application. The auxiliary contacts change position with the main contacts. The signalling contact signals tripping regardless if it was caused by short-circuit or overload. Undervoltage release are used for remote tripping of the manual motor starter especially for emergency stop circuits. Shunt trips release the MMS used for remote tripping.

### Ordering details

Suitable for	Auxiliary contacts N.O.	Auxiliary contacts N.C.	Description	Type	Order code	Pkg qty	Weight (1 pce) kg
<b>Auxiliary contacts – mountable on the front</b>							
MS325,	1	1		HKF-11	1SAM101928R0001	10	0.015
MO325	2	0		HKF-20	1SAM101928R0002	10	0.020
<b>Auxiliary contacts – mountable on the left</b>							
MS325,	1	1	Max. 2 pieces	HK-11	1SAM101901R0001	2	0.030
MO325	2	0	Max. 2 pieces	HK-20	1SAM101901R0002	2	0.030
	0	2	Max. 2 pieces	HK-02	1SAM101901R0003	2	0.030
<b>Signalling contacts – mountable on the left</b>							
MS325,	1	1	For tripped alarm,	SK-11	1SAM101904R0003	10	0.030
MO325			max. 1 piece				
<b>Signalling contacts – mountable on the right</b>							
MS325,	1	1	For short-circuit alarm	CK-11	1SAM101943R0001	10	0.035
MO325							

Suitable for	Rated control supply voltage V	Frequency Hz	Type	Order code	Pkg qty	Weight (1 pce) kg
<b>Shunt trips – mountable as slide in</b>						
MS325,	24 ... 60	50/60	AA-24	1SAM101909R0001	10	0.025
MO325	110 ... 240	50/60	AA-230	1SAM101909R0002	10	0.025
	220 ... 415	50/60	AA-400	1SAM101909R0003	10	0.025
<b>Undervoltage releases – mountable as slide in</b>						
MS325,	24	50	UAF-24	1SAM101903R0024	10	0.02
MO325	48	50	UAF-48	1SAM101903R0048	10	0.02
	60	50	UAF-60	1SAM101903R0060	10	0.02
	110	50	UAF-110	1SAM101903R0110	10	0.02
	230	50	UAF-230	1SAM101903R0230	10	0.02
	400	50	UAF-400	1SAM101903R0400	10	0.02
	415	50	UAF-415	1SAM101903R0415	10	0.02
	500	50	UAF-500	1SAM101903R0500	10	0.02

# MS325, MO325 manual motor starters

## Main accessories



2CDC241004F0010

IB325-Y



2CDC241003F0010

IB325-G



2CDC241002F0010

DMS325-Y



2CDC241001F0010

DMS325-G

### Description

IB325 are IP65 enclosures for single MMS installation. Additional mounting of auxiliary and signalling contacts, shunt trips and undervoltage release is possible. The handle is lockable in OFF position. For detailed specification see installation instruction.

DMS325 are IP65 door mounting kits for MMS installation in any enclosure. Additional mounting of auxiliary, signalling, shunt trips and undervoltage release is possible. The handle is lockable in OFF position. For detailed specification see installation instruction.

### Ordering details

Suitable for	Description	Color	Type	Order code	Pkg qty	Weight (1 pce) kg
<b>IP65 enclosures</b>						
MS325,	Padlockable max. 3 padlocks with bail diameter 4 ... 6.5 mm	Yellow/red	IB325-G	1SAM101940R1000	1	0.370
MO325		Grey/black	IB325-Y	1SAM101940R1001	1	0.370
<b>IP65 door mounting kits</b>						
MS325,	Padlockable max. 3 padlocks with bail diameter 4 ... 6.5 mm	Yellow/red	DMS325-G	1SAM101941R1000	1	0.170
MO325		Grey/black	DMS325-Y	1SAM101941R1001	1	0.170

Indication I-O and ON-OFF

Please check for further equipment chapter General accessories.

### Main dimensions mm, inches

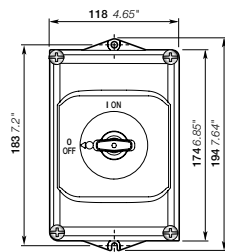

IB325

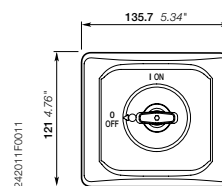
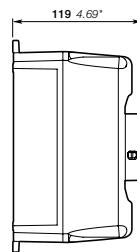

DMS325

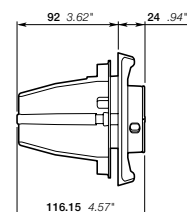

2CDC242012F0011

# MS116, MS132, MO132, MS4xx, MO4xx, MS325, MO325

## General accessories

2



2CDC241003F0011

MSHD-LB



2CDC241002S0011

MSHD-LY



2CDC241004F0011

MSMN



2CDC241001F0012

MSH-AR

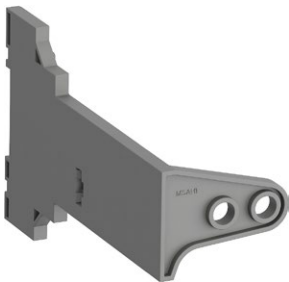

2CDC241017V0013

MSAH1

### Description

With this solution of door coupling rotary mechanism it is possible to operate a manual motor starter in the back of a switch cabinet from outside. The door coupling mechanism prevents opening of the door of a switch cabinet with the manual motor starter in ON position.

The complete mechanism includes handle, shaft, driver, shaft alignment ring and shaft supporter.

All accessories fit for 6 mm shafts with a maximum length of 180 mm. The degree of protection for handles MSHD is IP64.

### Ordering details

Suit-able for	Description	Shaft length mm	Color	Type	Order code	Pkg qty	Weight (1 pcs) kg
<b>Shafts</b>							
MS116,	For MSHD handles. Shaft diameter 6 mm. Shaft extension for door coupling driver.	85		OXS6X85	1SCA101647R1001	1	0.020
MS132,		105		OXS6X105	1SCA108043R1001	1	0.020
MO132,		130		OXS6X130	1SCA101655R1001	1	0.030
MS4xx,		180		OXS6X180	1SCA101659R1001	1	0.040
MO4xx,							
MS325,							
MO325							
<b>IP64 handles (UL: Type 1, 3R, 12)</b>							
MS116,	Padlockable max. 3 padlocks with bail diameter 5 ... 8 mm, door interlock in ON position defeatable, for use with 6 mm OXS6...types up to 180 mm or driver shafts MSOX.		Black	MSHD-LB <sup>1)</sup>	1SAM201920R1001	1	0.065
MS132,			Yellow	MSHD-LY <sup>1)</sup>	1SAM201920R1002	1	0.065
MO132,			Black	MSHD-LTB <sup>2)</sup>	1SAM201920R1011	1	0.065
MS4xx,			Yellow	MSHD-LTY <sup>2)</sup>	1SAM201920R1012	1	0.065
MO4xx,							
MS325,							
MO325							
<b>Driver</b>							
MS116,	Coupling driver for use with 6 mm OXS6... types up to 180 mm.			MSMN <sup>3)</sup>	1SAM101923R0002	1	0.002
MS132,				MSMNO <sup>4)</sup>	1SAM101923R0012	1	0.002
MO132,							
MS4xx,							
MO4xx,							
MS325,							
MO325							
<b>Shaft alignment ring</b>							
MS116,	The MSH-AR supports the long shafts for alignment to the handle inlet. It makes closing panel doors more easy. Use for OXS6X > 105 mm.			MSH-AR	1SAM201920R1000	1	0.010
MS132,							
MO132,							
MS4xx,							
MO4xx,							
MS325,							
MO325							
<b>Shaft supporter</b>							
MS116,	With the MSAH1 it is possible to support the shaft in the extension of handle (MSHD). It is mandatory for the usage of shafts >130 mm.			MSAH1	1SAM201909R1021	1	0.035
MS132,							
MO132							

<sup>1)</sup> Indication I-O and ON-OFF (recommended for MS116, MS4xx, MO4xx)

<sup>2)</sup> Indication I-O and ON-OFF + Trip indication

<sup>3)</sup> Coded - Positioning of ON indication dependent from mounting orientation of the MMS

<sup>4)</sup> Uncoded - Positioning of ON indication independent from mounting orientation of the MMS



# MS116, MS132, MO132, MS4xx, MO4xx, MS325, MO325

## General accessories

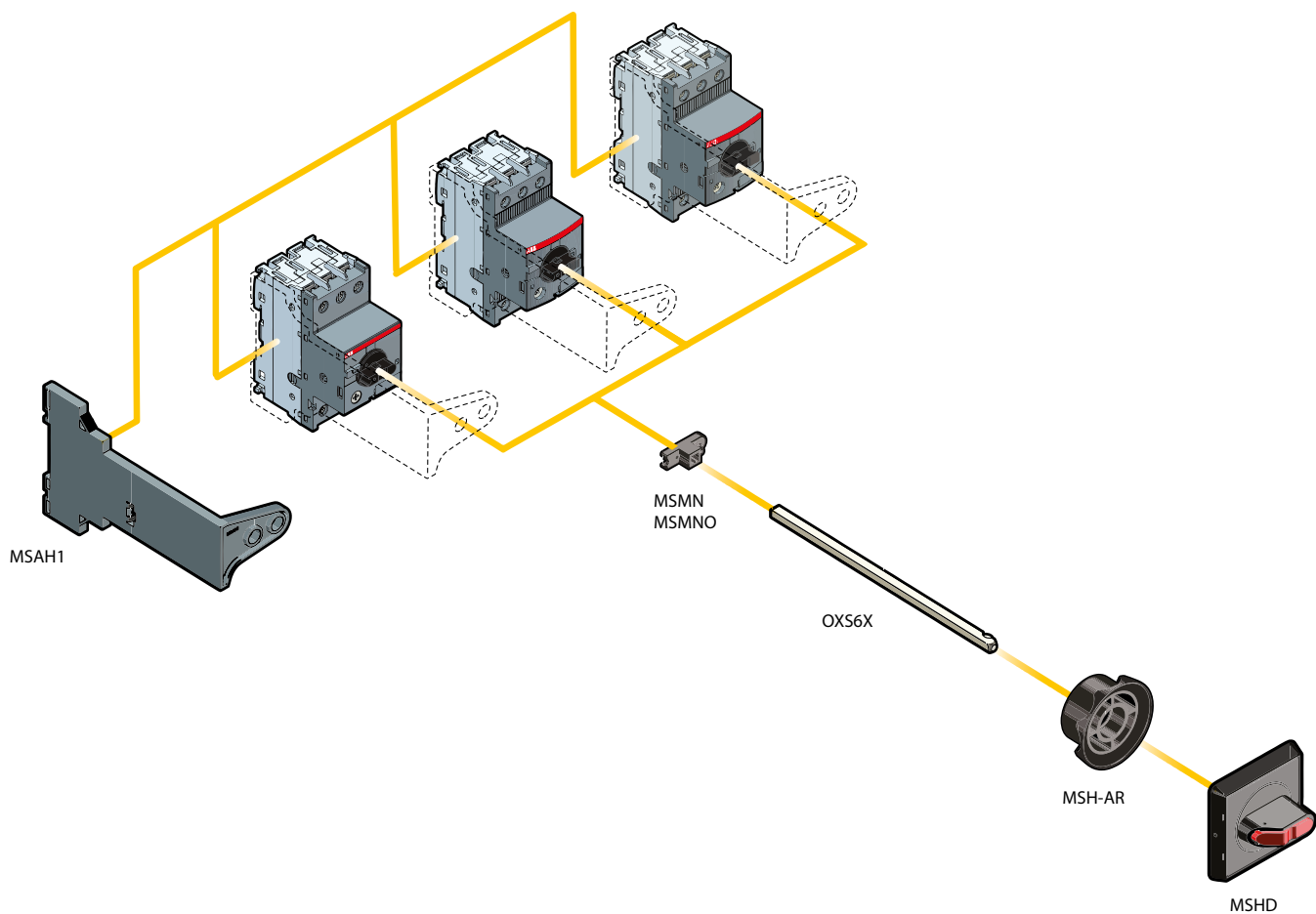



# B mini contactors

## K mini contactor relays

### [Overview](#) 3/2

---

#### With screw terminals

##### 3-pole contactors

B6, B7	AC operated	3/4
BC6, BC7, B7D	DC operated	3/5

##### 3-pole reversing contactors

VB6, VB7	AC operated	3/6
VBC6, VBC7	DC operated	3/7

##### 3-pole interface contactors

BC6, BC7	DC operated	3/8
----------	-------------	-----

##### 3-pole contactors - large coil voltage range

TBC7	DC operated	3/9
------	-------------	-----

##### 4-pole contactors

B6, B7	AC operated	3/10
BC6, B7D	DC operated	3/11

##### 4-pole contactors - large coil voltage range

TBC7	DC operated	3/12
------	-------------	------

##### Contactors relays

K6	AC operated	3/13
KC6	DC operated	3/14

##### Interface contactor relays

KC6	DC operated	3/15
-----	-------------	------

##### Contactors relays - large coil voltage range

TKC6	DC operated	3/16
------	-------------	------



### [Accessories](#) 3/17

---

For direct product details information, use product type or order code, ex:  
[www.abb.com/productdetails/AF09-30-10-13](http://www.abb.com/productdetails/AF09-30-10-13) or [www.abb.com/productdetails/1SBL137001R1310](http://www.abb.com/productdetails/1SBL137001R1310)

# Mini contactors



			Screw terminals					
<b>AC Control supply</b> 								
3-pole contactors			Coil consumption 3.5 W	Type	B6	B7	-	-
3-pole reversing contactors			Coil consumption 3.5 W	Type	-	-	VB6 VB6A <sup>2)</sup>	VB7 VB7A <sup>2)</sup>
4-pole contactors			Coil consumption 3.5 W	Type	B6	B7	-	-
<b>DC Control supply</b> 								
3-pole contactors			Coil consumption 3.5 W	Type	BC6	BC7 B7D <sup>1)</sup>	-	-
3-pole interface contactors			Coil consumption 1.4 ... 2.4 W	Type	BC6	BC7	-	-
3-pole reversing contactors			Coil consumption 3.5 W	Type	-	-	VBC6 VBC6A <sup>2)</sup>	VBC7 VBC7A <sup>2)</sup>
4-pole contactors			Coil consumption 3.5 W	Type	BC6	B7D	-	-
Wide range types			Extended coil voltage and temperature	Type	-	TBC7	-	-
PLC types			Coil consumption 1.7 W	Type	B6S <sup>1)</sup>	B7S <sup>1)</sup>	-	-
IEC	Rated operational power AC-3	220-230-240 V	kW	2.2	3	2.2	3	
		380-400 V	kW	4	5.5	4	5.5	
	Rated operational current AC-1	400 V, $\theta \leq 40^\circ\text{C}$	A	20	20	20	20	
UL/CSA	3-phase motor rating	220-240 V AC	hp	2	3	2	3	
		440-480 V AC	hp	3	5	3	5	
	General use rating		A	12 (300 V)	16 (600 V)	12 (300 V)	16 (600 V)	

<sup>1)</sup> With integrated surge suppressor

<sup>2)</sup> With safety blocking function

## Main accessories

Auxiliary contact blocks	Front mounting	CAF6
	Side mounting	CA6
Connection sets	For reversing contactors	BSM6-30
Surge suppressors	Varistor (AC/DC)	RV-BC6

## Overload relays



Thermal overload relays	Class 10	T16
Thermal and phase failure protection, with single setup possible		
Electronic overload relays	Class 10E, 20E, 30E	E16DU
With single setup possible		

## Manual motor starters

Thermal / magnetic protection	Class 10	MS116, MS132
Magnetic only types		MO132
Connecting link to manual motor starters		BEA7/132

# Contactor relays



			Screw terminals			
<b>AC Control supply</b> 						
4-pole contactor relays			Coil consumption 3.5 W	Type	K6	
<b>DC Control supply</b> 						
4-pole contactor relays			Coil consumption 3.5 W	Type	KC6	
4-pole interface contactor relays			Coil consumption 1.4 ... 2.4 W	Type	KC6	
Wide range types			Extended coil voltage and temperature	Type	TKC6	
IEC	Rated operational current AC-15	220-230-240 V	A	4		
		380-400 V	A	3		
	Rated operational current DC-13	24 V	A	2.5		
<b>Main accessories</b>						
Auxiliary contact blocks	Front mounting	CAF6				
	Side mounting	CA6-11K				



Soldering pins				Flat pins			
B6...P	B7...P	-	-	B6...F	B7...F	-	-
-	-	VB6...P	VB7...P	-	-	VB6...F	VB7...F
-	-	VB6A...P <sup>2)</sup>	VB7A...P <sup>2)</sup>	-	-	VB6A...F <sup>2)</sup>	VB7A...F <sup>2)</sup>
-	-	-	-	-	-	-	-
BC6...P	BC7...P	-	-	BC6...F	BC7...F	-	-
-	B7D...P <sup>1)</sup>	-	-	-	B7D...F <sup>1)</sup>	-	-
BC6...P	BC7...P	-	-	BC6...F	BC7...F	-	-
-	-	VBC6...P	VBC7...P	-	-	VBC6...F	VBC7...F
-	-	VBC6A...P <sup>2)</sup>	VBC7A...P <sup>2)</sup>	-	-	VBC6A...F <sup>2)</sup>	VBC7A...F <sup>2)</sup>
-	-	-	-	-	-	-	-
2,2	3	2,2	3	2,2	3	2,2	3
4	5,5	4	5,5	4	5,5	4	5,5
12	12	12	12	20	20	20	20
2	3	2	3	2	3	2	3
3	5	3	5	3	5	3	5
12 (300 V)	16 (600 V)	12 (300 V)	16 (600 V)	12 (300 V)	16 (600 V)	12 (300 V)	16 (600 V)

-	-
CA6-11K-P	CA6-11K-F
-	-
-	-

-	-
-	-

MS116, MS132	MS116, MS132
MO132	MO132
-	-



Soldering pins		Flat pins	
K6...P		K6...F	
KC6...P		KC6...F	
KC6...P		KC6...F	
4		4	
3		3	
2,5		2,5	
-		-	
CA6-11K-P		CA6-11K-F	

# B6, B7 3-pole mini contactors – with screw terminals

## 4 to 5.5 kW

### AC operated



2CDC211001F0010

B6-30-10

3



2CDC211014F0011

B7-30-10

#### Description

B6, B7 3-pole mini contactors are compact control products mainly used for switching resistive or motor loads up to 690 V AC.

These contactors are designed with:

- 3 main poles and one built-in auxiliary contact
- control circuit: AC operated
  - low coil consumption (3.5 VA at pull-in and at holding)
- add-on auxiliary contact blocks for front or side mounting and a wide range of accessories
- hum-free coil
- designed for rail or wall mounting

#### Ordering details

IEC		UL/CSA		Rated control circuit voltage $U_c$		Auxiliary contacts fitted	Type	Order code	Pkg qty	Weight (1 pce)
Rated operational power	current $\theta \leq 40^\circ\text{C}$	3-phase motor rating	General use rating	50 Hz	60 Hz					kg
400 V AC-3 kW	AC-1 A	480 V hp		V AC	V AC					

#### B6 mini contactors

4	20	3	300 V / 12 A	24	24	1 0	B6-30-10-01	GJL1211001R0101	10	0.175
						0 1	B6-30-01-01	GJL1211001R0011	10	0.175
				42	42	1 0	B6-30-10-02	GJL1211001R0102	10	0.175
						0 1	B6-30-01-02	GJL1211001R0012	10	0.175
				48	48	1 0	B6-30-10-03	GJL1211001R0103	10	0.175
						0 1	B6-30-01-03	GJL1211001R0013	10	0.175
				110 ... 127	110 ... 127	1 0	B6-30-10-84	GJL1211001R8104	10	0.175
						0 1	B6-30-01-84	GJL1211001R8014	10	0.175
				220 ... 240	220 ... 240	1 0	B6-30-10-80	GJL1211001R8100	10	0.175
						0 1	B6-30-01-80	GJL1211001R8010	10	0.175
				380 ... 415	380 ... 415	1 0	B6-30-10-85	GJL1211001R8105	10	0.175
						0 1	B6-30-01-85	GJL1211001R8015	10	0.175

#### B7 mini contactors

5.5	20	5	600 V / 16 A	24	24	1 0	B7-30-10-01	GJL1311001R0101	10	0.175
						0 1	B7-30-01-01	GJL1311001R0011	10	0.175
				42	42	1 0	B7-30-10-02	GJL1311001R0102	10	0.175
						0 1	B7-30-01-02	GJL1311001R0012	10	0.175
				48	48	1 0	B7-30-10-03	GJL1311001R0103	10	0.175
						0 1	B7-30-01-03	GJL1311001R0013	10	0.175
				110 ... 127	110 ... 127	1 0	B7-30-10-84	GJL1311001R8104	10	0.175
						0 1	B7-30-01-84	GJL1311001R8014	10	0.175
				220 ... 240	220 ... 240	1 0	B7-30-10-80	GJL1311001R8100	10	0.175
						0 1	B7-30-01-80	GJL1311001R8010	10	0.175
				380 ... 415	380 ... 415	1 0	B7-30-10-85	GJL1311001R8105	10	0.175
						0 1	B7-30-01-85	GJL1311001R8015	10	0.175

Other types on request

#### Main dimensions mm, inches

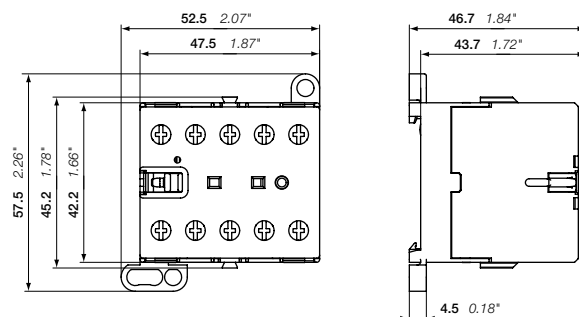

B6, B7

2CDC212001F0011

2CDC102008C0201

# BC6, BC7, B7D 3-pole mini contactors – with screw terminals

## 4 to 5.5 kW

### DC operated



BC6-30-10

2DCD211040F0011



BC7-30-10

2DCD211013F0011

#### Description

BC6, BC7, B7D 3-pole mini contactors are compact control products mainly used for switching resistive or motor loads up to 690 V AC.

These contactors are designed with:

- 3 main poles and one built-in auxiliary contact
- control circuit: DC operated, low consumption (3.5 W at pull-in and at holding)
- hum-free coil
- add-on auxiliary contact blocks for front or side mounting and a wide range of accessories
- designed for rail or wall mounting

#### Ordering details

IEC	UL/CSA		Rated control circuit voltage: $U_c$	Auxiliary contacts fitted	Type	Order code	Pkg qty	Weight (1 pce)
Rated operational power	current $\theta \leq 40^\circ\text{C}$	3-phase motor rating	General use rating					kg
400 V AC-3 kW	AC-1 A	hp	480 V					

#### BC6 mini contactors

Rated operational power	current	3-phase motor rating	General use rating	Rated control circuit voltage: $U_c$	Auxiliary contacts fitted	Type	Order code	Pkg qty	Weight (1 pce)
4	20	3	300 V / 12 A	12	1 0	BC6-30-10-07	GJL1213001R0107	10	0.175
					0 1	BC6-30-01-07	GJL1213001R0017	10	0.175
				24	1 0	BC6-30-10-01	GJL1213001R0101	10	0.175
					0 1	BC6-30-01-01	GJL1213001R0011	10	0.175
				48	1 0	BC6-30-10-16	GJL1213001R1106	10	0.175
					0 1	BC6-30-01-16	GJL1213001R1016	10	0.175
				60	1 0	BC6-30-10-03	GJL1213001R0103	10	0.175
					0 1	BC6-30-01-03	GJL1213001R0013	10	0.175
				110 ... 125	1 0	BC6-30-10-04	GJL1213001R0104	10	0.175
					0 1	BC6-30-01-04	GJL1213001R0014	10	0.175
				220 ... 240	1 0	BC6-30-10-05	GJL1213001R0105	10	0.175
					0 1	BC6-30-01-05	GJL1213001R0015	10	0.175

#### BC7 mini contactors

Rated operational power	current	3-phase motor rating	General use rating	Rated control circuit voltage: $U_c$	Auxiliary contacts fitted	Type	Order code	Pkg qty	Weight (1 pce)
5.5	20	5	600 V / 16 A	12	1 0	BC7-30-10-07	GJL1313001R0107	10	0.175
					0 1	BC7-30-01-07	GJL1313001R0017	10	0.175
				24	1 0	BC7-30-10-01	GJL1313001R0101	10	0.175
					0 1	BC7-30-01-01	GJL1313001R0011	10	0.175
				48	1 0	BC7-30-10-16	GJL1313001R1106	10	0.175
					0 1	BC7-30-01-16	GJL1313001R1016	10	0.175
				60	1 0	BC7-30-10-03	GJL1313001R1103	10	0.175
					0 1	BC7-30-01-03	GJL1313001R0013	10	0.175
				110 ... 125	1 0	BC7-30-10-04	GJL1313001R0104	10	0.175
					0 1	BC7-30-01-04	GJL1313001R0014	10	0.175
				220 ... 240	1 0	BC7-30-10-05	GJL1313001R0105	10	0.175
					0 1	BC7-30-01-05	GJL1313001R0015	10	0.175

#### B7D mini contactors with integrated suppressor diode

Rated operational power	current	3-phase motor rating	General use rating	Rated control circuit voltage: $U_c$	Auxiliary contacts fitted	Type	Order code	Pkg qty	Weight (1 pce)
5.5	20	5	600 V / 16 A	24	1 0	B7D-30-10-01	GJL1317001R0101	10	0.175
					0 1	B7D-30-01-01	GJL1317001R0011	10	0.175
				220	1 0	B7D-30-10-05	GJL1317001R0105	10	0.175
					0 1	B7D-30-01-05	GJL1317001R0015	10	0.175

Other types on request

#### Main dimensions mm, inches

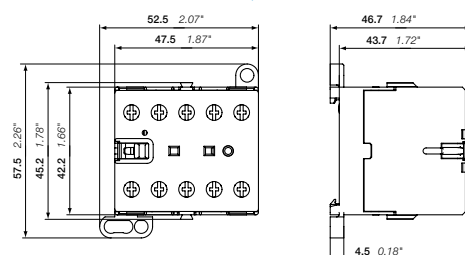

BC6, BC7, B7D

2DCD212001F0011

2DCD102015C0201

# VB6, VB7 3-pole mini reversing contactors – with screw terminals

## 4 to 5.5 kW

### AC operated



2CDC211006F0011

VB7-30-10

3

#### Description

VB6, VB7 3-pole compact design reversing contactors are space optimized control products mainly used for switching resistive or motor loads up to 690 V AC.

These reversing contactors are designed with:

- built-in mechanical interlock. The coils must be mutually interlocked electrically and coils must be de-energised for 50 ms at least to prevent phase to phase short circuit on the arc.
- control circuit: AC operated
  - low coil consumption (3.5 VA at pull-in and at holding)
- hum-free coil
- add-on auxiliary contact blocks for front mounting
- designed for rail or wall mounting

#### Ordering details

IEC		UL/CSA		Rated control circuit voltage $U_c$		Auxiliary contacts fitted	Type	Order code	Pkg qty	Weight (1 pce)				
Rated power	operational current $\theta \leq 40^\circ\text{C}$	3-phase motor rating	General use rating	50 Hz	60 Hz									
400 V AC-3 kW	AC-1 A	480 V hp		V AC	V AC					kg				
<b>VB6 mini reversing contactors</b>														
4	20	3	300 V / 12 A	24	24	1 0	VB6-30-10-01	GJL1211901R0101	5	0.355				
					24	0 1	VB6-30-01-01	GJL1211901R0011	5	0.355				
				42	42	1 0	VB6-30-10-02	GJL1211901R0102	5	0.355				
					42	0 1	VB6-30-01-02	GJL1211901R0012	5	0.355				
				48	48	1 0	VB6-30-10-03	GJL1211901R0103	5	0.355				
					48	0 1	VB6-30-01-03	GJL1211901R0013	5	0.355				
				110 ... 127	110 ... 127	1 0	VB6-30-10-84	GJL1211901R8104	5	0.355				
					110 ... 127	0 1	VB6-30-01-84	GJL1211901R8014	5	0.355				
				220 ... 240	220 ... 240	1 0	VB6-30-10-80	GJL1211901R8100	5	0.355				
					220 ... 240	0 1	VB6-30-01-80	GJL1211901R8010	5	0.355				
				380 ... 415	380 ... 415	1 0	VB6-30-10-85	GJL1211901R8105	5	0.355				
					380 ... 415	0 1	VB6-30-01-85	GJL1211901R8015	5	0.355				
				<b>VB7 mini reversing contactors</b>										
				5.5	20	5	600 V / 16 A	24	24	1 0	VB7-30-10-01	GJL1311901R0101	5	0.355
24	0 1	VB7-30-01-01	GJL1311901R0011						5	0.355				
42	42	1 0	VB7-30-10-02					GJL1311901R0102	5	0.355				
	42	0 1	VB7-30-01-02					GJL1311901R0012	5	0.355				
48	48	1 0	VB7-30-10-03					GJL1311901R0103	5	0.355				
	48	0 1	VB7-30-01-03					GJL1311901R0013	5	0.355				
110 ... 127	110 ... 127	1 0	VB7-30-10-84					GJL1311901R8104	5	0.355				
	110 ... 127	0 1	VB7-30-01-84					GJL1311901R8014	5	0.355				
220 ... 240	220 ... 240	1 0	VB7-30-10-80					GJL1311901R8100	5	0.355				
	220 ... 240	0 1	VB7-30-01-80					GJL1311901R8010	5	0.355				
380 ... 415	380 ... 415	1 0	VB7-30-10-85					GJL1311901R8105	5	0.355				
	380 ... 415	0 1	VB7-30-01-85					GJL1311901R8015	5	0.355				

Other types on request

#### Main dimensions mm, inches

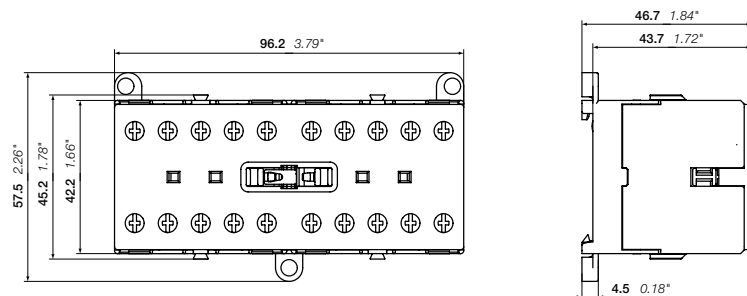

VB6, VB7

2CDC211006F0011

2CDC102016C0201



# VBC6, VBC7 3-pole mini reversing contactors – with screw terminals

## 4 to 5.5 kW

### DC operated



VBC6-30-10

20DC211042F0011



VBC7-30-10

20DC211001F0011

### Description

VBC6, VBC7 3-pole compact design reversing contactors are space optimized control products mainly used for switching resistive or motor loads up to 690 V AC.

These reversing contactors are designed with:

- built-in mechanical interlock. The coils must be mutually interlocked electrically and coils must be de-energised for 50 ms at least to prevent phase to phase short circuit on the arc.
- control circuit: DC operated
  - low coil consumption (3.5 W at pull-in and at holding)
- hum-free coil
- add-on auxiliary contact blocks for front mounting
- designed for rail or wall mounting

### Ordering details

IEC	UL/CSA	Rated control circuit voltage: $U_c$	Auxiliary contacts fitted	Type	Order code	Pkg qty	Weight (1 pce)
Rated operational power	3-phase motor rating	General use rating					kg
400 V AC-3 kW	AC-1 A hp	300 V / 12 A	V DC				

#### VBC6 mini reversing contactors

Rated operational power	3-phase motor rating	General use rating	Rated control circuit voltage: $U_c$	Auxiliary contacts fitted	Type	Order code	Pkg qty	Weight (1 pce)	
4	20	3	300 V / 12 A	1 0	VBC6-30-10-07	GJL1213901R0107	5	0.355	
						0 1	VBC6-30-01-07	GJL1213901R0017	5
				24	1 0	VBC6-30-10-01	GJL1213901R0101	5	0.355
				48	1 0	VBC6-30-10-16	GJL1213901R1106	5	0.355
				60	1 0	VBC6-30-10-03	GJL1213901R0103	5	0.355
				110 ... 125	1 0	VBC6-30-10-04	GJL1213901R0104	5	0.355
				220 ... 240	1 0	VBC6-30-10-05	GJL1213901R0105	5	0.355

#### VBC7 mini reversing contactors

Rated operational power	3-phase motor rating	General use rating	Rated control circuit voltage: $U_c$	Auxiliary contacts fitted	Type	Order code	Pkg qty	Weight (1 pce)	
5.5	20	5	600 V / 16 A	1 0	VBC7-30-10-07	GJL1313901R0107	5	0.355	
						0 1	VBC7-30-01-07	GJL1313901R0017	5
				24	1 0	VBC7-30-10-01	GJL1313901R0101	5	0.355
				48	1 0	VBC7-30-10-16	GJL1313901R1106	5	0.355
				60	1 0	VBC7-30-10-03	GJL1313901R0103	5	0.355
				110 ... 125	1 0	VBC7-30-10-04	GJL1313901R0104	5	0.355
				220 ... 240	1 0	VBC7-30-10-05	GJL1313901R0105	5	0.355

Other types on request

### Main dimensions mm, inches

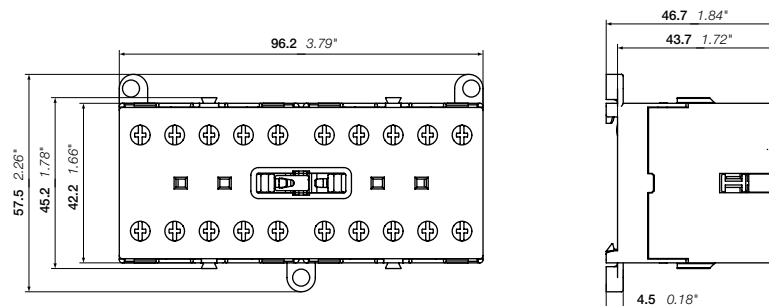

VBC6, VBC7

20DC212006F0011

20DC102017C0201

# BC6, BC7 3-pole interface mini contactors – with screw terminals

## 4 to 5.5 kW

### DC operated



2CDC211040F0011

BC6-30-10

3



2CDC211019F0011

BC7-30-10

#### Description

BC6, BC7 3-pole interface mini contactors are compact control products mainly used for switching resistive or motor loads up to 690 V AC.

These contactors are designed with:

- 3 main poles and one built-in auxiliary contact
- control circuit: DC operated, very low coil consumption. Suitable for direct control by PLC outputs
- hum-free coil
- no auxiliary contact block permitted for mounting
- designed for rail or wall mounting

#### Ordering details

IEC	UL/CSA	Rated control circuit voltage $U_c$	Auxiliary contacts fitted	Type	Order code	Pkg qty	Weight (1 pce)
Rated operational power	3-phase: motor rating $\theta \leq 40^\circ\text{C}$	General use rating					
400 V AC-3 kW	AC-1 hp	480 V					kg
<b>DC operation 24 V / 1.4 W</b>							
4	20	3	300 V / 12 A	24	1 0 BC6-30-10-1.4-81 0 1 BC6-30-01-1.4-81	GJL1213001R8101	10 0.175
5.5	20	5	600 V / 16 A	24	1 0 BC7-30-10-1.4-81 0 1 BC7-30-01-1.4-81	GJL1313001R8101	10 0.175
<b>DC operation 17 ... 32 V / 2.4 W</b>							
4	20	3	300 V / 12 A	17 ... 32	1 0 BC6-30-10-2.4-51 0 1 BC6-30-01-2.4-51	GJL1213001R5101	10 0.175
5.5	20	5	600 V / 16 A	17 ... 32	1 0 BC7-30-10-2.4-51 0 1 BC7-30-01-2.4-51	GJL1313001R5101	10 0.175

#### Connection to PLCs with integrated protective circuit

<b>DC operation 24 V / 1.7 W</b>							
4	20	3	300 V / 12 A	24	1 0 B6S-30-10-1.7-71 0 1 B6S-30-01-1.7-71	GJL1213001R7101	10 0.175
5.5	20	5	600 V / 16 A	24	1 0 B7S-30-10-1.7-71 0 1 B7S-30-01-1.7-71	GJL1313001R7101	10 0.175
<b>DC operation 17 ... 32 V / 2.8 W</b>							
4	20	3	300 V / 12 A	17 ... 32	1 0 B6S-30-10-2.8-72 0 1 B6S-30-01-2.8-72	GJL1213001R7102	10 0.175
5.5	20	5	600 V / 16 A	17 ... 32	1 0 B7S-30-10-2.8-72 0 1 B7S-30-01-2.8-72	GJL1313001R7102	10 0.175

Other types on request

#### Main dimensions mm, inches

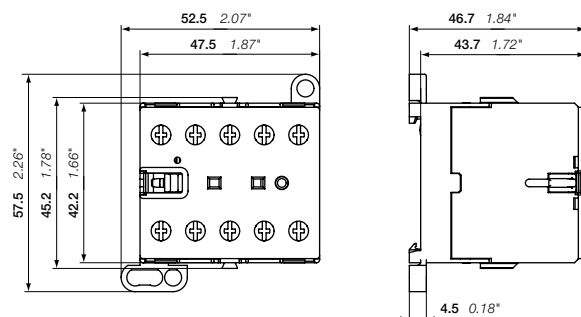

BC6, BC7

2CDC212001F0011

2CDC102010C0201

# TBC7 3-pole mini contactors – with screw terminals

## 4 to 5.5 kW

### DC operated – large coil voltage range



TBC7-30-10

#### Description

TBC7 3-pole mini contactors are compact control products mainly used for switching resistive or motor loads up to 690 V AC.

These contactors are designed with:

- 3 main poles and one built-in auxiliary contact
- control circuit: DC operated
  - low coil consumption (5 W at pull-in and at holding)
- hum-free coil
- expanded ambient temperature range -30 ... +70 °C and wide range voltage supply
- no auxiliary contact block permitted for mounting
- designed for rail or wall mounting
- material is approved for railway applications

#### Ordering details

IEC		UL/CSA		Rated control circuit voltage: $U_{Cmin} \dots U_{Cmax}$	Auxiliary contacts fitted 	Type	Order code	Pkg qty	Weight (1 pce) kg
Rated power	operational current $\theta \leq 40 \text{ }^\circ\text{C}$	3-phase motor rating 480 V	General use rating						
400 V AC-3 kW	AC-1 A	hp		V DC					
<b>TBC7 mini contactors</b>									
5.5	20	5	600 V / 16 A	17 ... 32	1 0	TBC7-30-10-51	GJL1313061R5101	10	0.185
					0 1	TBC7-30-01-51	GJL1313061R5011	10	0.185
				50 ... 90	1 0	TBC7-30-10-55	GJL1313061R5105	10	0.185
					0 1	TBC7-30-01-55	GJL1313061R5015	10	0.185
				77 ... 143	1 0	TBC7-30-10-62	GJL1313061R6102	10	0.185
					0 1	TBC7-30-01-62	GJL1313061R6012	10	0.185
				140 ... 260	1 0	TBC7-30-10-68	GJL1313061R6108	10	0.185
					0 1	TBC7-30-01-68	GJL1313061R6018	10	0.185

Other types on request

#### Main dimensions mm, inches

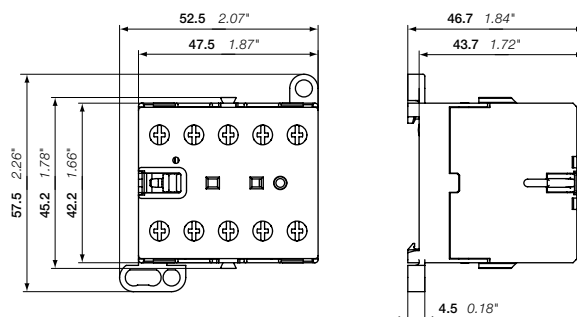

TBC7

2CDC212001F0011

2CDC102020 C0201

# B6, B7 4-pole mini contactors – with screw terminals

## 4 to 5.5 kW

### AC operated



2CDC211028F0011

B6-22-00

3

#### Description

B6, B7 4-pole mini contactors are compact control products mainly used for switching resistive loads up to 690 V AC.

These contactors are designed with:

- 4 main poles
- control circuit: AC operated
  - low coil consumption (3.5 VA at pull-in and at holding)
- add-on auxiliary contact blocks for front or side mounting and a wide range of accessories
- hum-free coil
- designed for rail or wall mounting

#### Ordering details

IEC	UL/CSA	Rated control circuit voltage $U_c$	Auxiliary contacts fitted	Type	Order code	Pkg qty	Weight (1 pce)
Rated operational current $I_n$ $\theta \leq 40^\circ\text{C}$ AC-1	General use rating	50/60 Hz					
A		V AC					kg
<b>4 N.O. main poles</b>							
20	300 V / 12 A	24	0 0	B6-40-00-01	GJL1211201R0001	10	0.175
		42	0 0	B6-40-00-02	GJL1211201R0002	10	0.175
		48	0 0	B6-40-00-03	GJL1211201R0003	10	0.175
		110 ... 127	0 0	B6-40-00-84	GJL1211201R8004	10	0.175
		220 ... 240	0 0	B6-40-00-80	GJL1211201R8000	10	0.175
20	600 V / 16 A	24	0 0	B7-40-00-01	GJL1311201R0001	10	0.175
		42	0 0	B7-40-00-02	GJL1311201R0002	10	0.175
		48	0 0	B7-40-00-03	GJL1311201R0003	10	0.175
		110 ... 127	0 0	B7-40-00-84	GJL1311201R8004	10	0.175
		220 ... 240	0 0	B7-40-00-80	GJL1311201R8000	10	0.175
<b>2 N.O. + 2 N.C. main poles</b>							
20	300 V / 12 A	24	0 0	B6-22-00-01	GJL1211501R0001	10	0.175
		42	0 0	B6-22-00-02	GJL1211501R0002	10	0.175
		48	0 0	B6-22-00-03	GJL1211501R0003	10	0.175
		110 ... 127	0 0	B6-22-00-84	GJL1211501R8004	10	0.175
		220 ... 240	0 0	B6-22-00-80	GJL1211501R8000	10	0.175
20	600 V / 16 A	24	0 0	B7-22-00-01	GJL1311501R0001	10	0.175
		42	0 0	B7-22-00-02	GJL1311501R0002	10	0.175
		48	0 0	B7-22-00-03	GJL1311501R0003	10	0.175
		110 ... 127	0 0	B7-22-00-84	GJL1311501R8004	10	0.175
		220 ... 240	0 0	B7-22-00-80	GJL1311501R8000	10	0.175

Other types on request

#### Main dimensions mm, inches

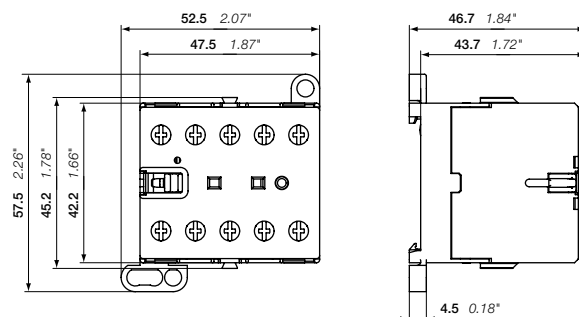

B6, B7

2CDC212001F0011

2CDC102009C0201

# BC6, B7D 4-pole mini contactors – with screw terminals

## 4 to 5.5 kW

### DC operated



BC6-22-00

2CDC211032F0011

#### Description

BC6, B7D 4-pole mini contactors are compact control products mainly used for switching resistive loads up to 690 V AC.

These contactors are designed with:

- 4 main poles
- control circuit: DC operated
  - low coil consumption (3.5 W at pull-in and at holding)
- hum-free coil
- add-on auxiliary contact blocks for front or side mounting
- designed for rail or wall mounting

#### Ordering details

IEC	UL/CSA	Rated control circuit voltage: $U_c$	Auxiliary contacts fitted	Type	Order code	Pkg qty	Weight (1 pce)
Rated operational current $\theta \leq 40^\circ\text{C}$ AC-1 A	General use rating	V DC					kg
<b>4 N.O. main poles</b>							
20	600 V / 16 A	24	0 0	B7D-40-00-01	GJL1317201R0001	10	0.175
		220	0 0	B7D-40-00-05	GJL1317201R0005	10	0.175
<b>2 N.O. + 2 N.C. main poles</b>							
20	300 V / 12 A	12	0 0	BC6-22-00-07	GJL1213501R0007	10	0.175
		24	0 0	BC6-22-00-01	GJL1213501R0001	10	0.175
		42	0 0	BC6-22-00-02	GJL1213501R0002	10	0.175
		48	0 0	BC6-22-00-16	GJL1213501R1006	10	0.175
		60	0 0	BC6-22-00-03	GJL1213501R0003	10	0.175
		110 ... 125	0 0	BC6-22-00-04	GJL1213501R0004	10	0.175
		220 ... 240	0 0	BC6-22-00-05	GJL1213501R0005	10	0.175

Other types on request

#### Main dimensions mm, inches

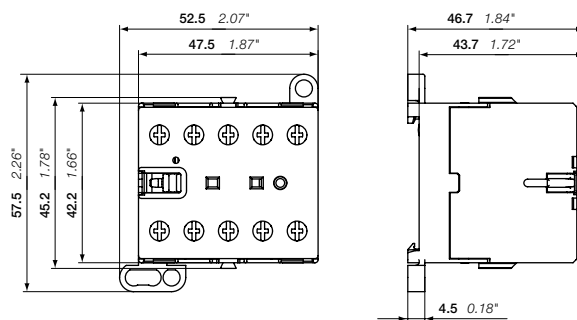

BC6, B7D

2CDC212001F0011

2CDC102021C0201

# TBC7 4-pole mini contactors – with screw terminals

## 4 to 5.5 kW

### DC operated – large coil voltage range



2CDC211028F0011

TBC7-31-00

3

#### Description

TBC7 4-pole mini contactors are compact control products mainly used for switching resistive or motor loads up to 690 V AC.

These contactors are designed with:

- 4 main poles
- control circuit: DC operated
  - low coil consumption (5 W at pull-in and at holding)
- hum-free coil
- expanded ambient temperature range -30 ... +70 °C and wide range voltage supply
- no auxiliary contact block permitted for mounting
- designed for rail or wall mounting
- material is approved for railway applications

#### Ordering details

IEC	UL/CSA	Rated control circuit voltage $U_{Cmin} \dots U_{Cmax}$	Auxiliary contacts fitted	Type	Order code	Pkg qty	Weight (1 pce)
Rated operational current $\theta \leq 40 \text{ }^\circ\text{C}$ AC-1 A	General use rating	V DC					kg
<b>3 N.O. + 1 N.C. main poles</b>							
20	600 V / 16 A	50 ... 90	0 0	TBC7-31-00-55	GJL1313461R5005	10	0.185
		77 ... 143	0 0	TBC7-31-00-62	GJL1313461R6002	10	0.185
		140 ... 260	0 0	TBC7-31-00-68	GJL1313461R6008	10	0.185
<b>2 N.O. + 2 N.C. main poles</b>							
20	600 V / 16 A	50 ... 90	0 0	TBC7-22-00-55	GJL1313561R5005	10	0.185
		77 ... 143	0 0	TBC7-22-00-62	GJL1313561R6002	10	0.185
		140 ... 260	0 0	TBC7-22-00-68	GJL1313561R6008	10	0.185

Other types on request

#### Main dimensions mm, inches

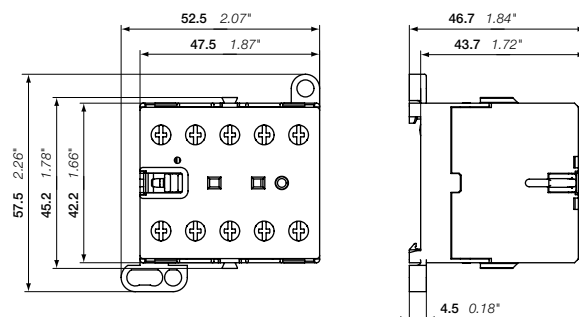

TBC7

2CDC212001F0011

2CDC102022C0201

# K6 4-pole mini contactor relays – with screw terminals AC operated



K6-22Z



K6-31Z

## Description

K6 4-pole mini-contactor relays are space optimized control products mainly used for control functions or for small loads up to 4 A.

These contactors are designed with:

- 4-poles with various contact combinations
- control circuit: AC operated
  - low coil consumption (3.5 VA at pull-in and at holding)
  - hum-free coil
- add-on auxiliary contact blocks for front or side mounting
- designed for rail or wall mounting

## Ordering details

Rated control circuit voltage $U_c$	Type	Order code	Pkg qty	Weight (1 pce)
50 Hz				kg
V AC	60 Hz			
	V AC			

### K6 4-pole mini contactor relays

24	24	K6-22Z-01	GJH1211001R0221	10	0.175
42	42	K6-22Z-02	GJH1211001R0222	10	0.175
48	48	K6-22Z-03	GJH1211001R0223	10	0.175
110 ... 127	110 ... 127	K6-22Z-84	GJH1211001R8224	10	0.175
220 ... 240	220 ... 240	K6-22Z-80	GJH1211001R8220	10	0.175
380 ... 415	380 ... 415	K6-22Z-85	GJH1211001R8225	10	0.175
24	24	K6-31Z-01	GJH1211001R0311	10	0.175
42	42	K6-31Z-02	GJH1211001R0312	10	0.175
48	48	K6-31Z-03	GJH1211001R0313	10	0.175
110 ... 127	110 ... 127	K6-31Z-84	GJH1211001R8314	10	0.175
220 ... 240	220 ... 240	K6-31Z-80	GJH1211001R8310	10	0.175
380 ... 415	380 ... 415	K6-31Z-85	GJH1211001R8315	10	0.175
24	24	K6-40E-01	GJH1211001R0401	10	0.175
42	42	K6-40E-02	GJH1211001R0402	10	0.175
48	48	K6-40E-03	GJH1211001R0403	10	0.175
110 ... 127	110 ... 127	K6-40E-84	GJH1211001R8404	10	0.175
220 ... 240	220 ... 240	K6-40E-80	GJH1211001R8400	10	0.175
380 ... 415	380 ... 415	K6-40E-85	GJH1211001R8405	10	0.175

Other types on request

## Main dimensions mm, inches

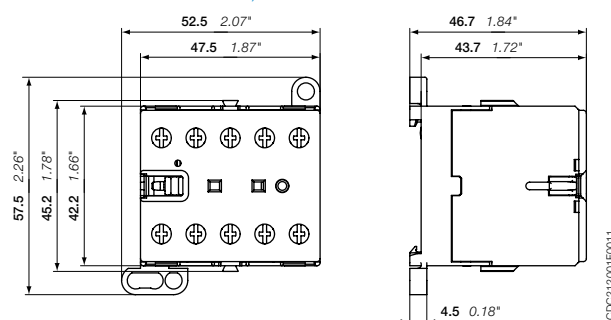

K6

# KC6 4-pole mini contactor relays – with screw terminals DC operated



2CDC21101F0011

KC6-22Z

3

## Description

KC6 4-pole mini-contactor relays are space optimized control products mainly used for control functions or for small loads up to 4 A.

These contactors are designed with:

- 4-poles with various contact combinations
- control circuit: DC operated
  - low coil consumption (3.5 W at pull-in and at holding)
- hum-free coil
- add-on auxiliary contact blocks for front or side mounting
- designed for rail or wall mounting

## Ordering details

Rated control circuit voltage $U_c$ V DC	Type	Order code	Pkg qty	Weight (1 pce) kg
<b>KC6 4-pole mini contactor relays</b>				
12	KC6-22Z-07	GJH1213001R0227	10	0.175
24	KC6-22Z-01	GJH1213001R0221	10	0.175
48	KC6-22Z-16	GJH1213001R1226	10	0.175
60	KC6-22Z-03	GJH1213001R0223	10	0.175
110 ... 125	KC6-22Z-04	GJH1213001R0224	10	0.175
220 ... 240	KC6-22Z-05	GJH1213001R0225	10	0.175
12	KC6-31Z-07	GJH1213001R0317	10	0.175
24	KC6-31Z-01	GJH1213001R0311	10	0.175
48	KC6-31Z-16	GJH1213001R1316	10	0.175
60	KC6-31Z-03	GJH1213001R0313	10	0.175
110 ... 125	KC6-31Z-04	GJH1213001R0314	10	0.175
220 ... 240	KC6-31Z-05	GJH1213001R0315	10	0.175
12	KC6-40E-07	GJH1213001R0407	10	0.175
24	KC6-40E-01	GJH1213001R0401	10	0.175
48	KC6-40E-16	GJH1213001R1406	10	0.175
60	KC6-40E-03	GJH1213001R0403	10	0.175
110 ... 125	KC6-40E-04	GJH1213001R0404	10	0.175
220 ... 240	KC6-40E-05	GJH1213001R0405	10	0.175

Other types on request

## Main dimensions mm, inches

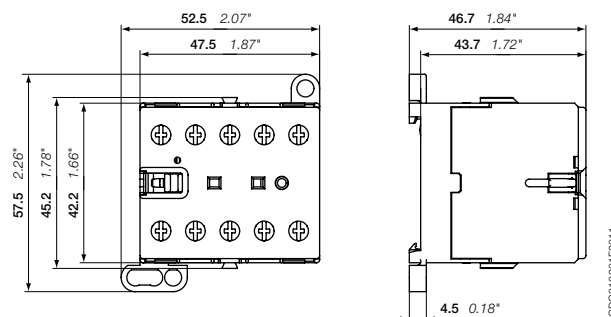

KC6

2CDC211001F0011

2CDC102012C0201



# KC6 4-pole interface mini contactor relays – with screw terminals DC operated



KC6-31Z

2CDC211011F0011

## Description

KC6 4-pole interface mini-contactor relays are space optimized control products mainly used for control functions or for small loads up to 4 A.

These contactors are designed with:

- 4-poles with various contact combinations
- control circuit: DC operated
  - low coil consumption (1.4 ... 2.8 W at pull-in and at holding)
- hum-free coil
- no auxiliary contact block permitted for mounting
- designed for rail or wall mounting

## Ordering details

Rated control circuit voltage $U_c$ V DC	Type	Order code	Pkg qty	Weight (1 pce) kg
<b>DC operation 24 V / 1.4 W</b>				
24	KC6-31Z-1.4-81	GJH1213001R8311	10	0.175
24	KC6-40E-1.4-81	GJH1213001R8401	10	0.175
<b>DC operation 17 ... 32 V / 2.4 W</b>				
17 ... 32	KC6-31Z-2.4-51	GJH1213001R5311	10	0.175
17 ... 32	KC6-40E-2.4-51	GJH1213001R5401	10	0.175
<b>DC operation 24 V / 1.7 W</b>				
24	K6S-22Z-1.7-71	GJH1213001R7221	10	0.175
24	K6S-31Z-1.7-71	GJH1213001R7311	10	0.175
24	K6S-40E-1.7-71	GJH1213001R7401	10	0.175
<b>DC operation 17 ... 32 V / 2.8 W</b>				
17 ... 32	K6S-22Z-2.8-72	GJH1213001R7222	10	0.175
17 ... 32	K6S-31Z-2.8-72	GJH1213001R7312	10	0.175
17 ... 32	K6S-40E-2.8-72	GJH1213001R7402	10	0.175

Other types on request

## Main dimensions mm, inches

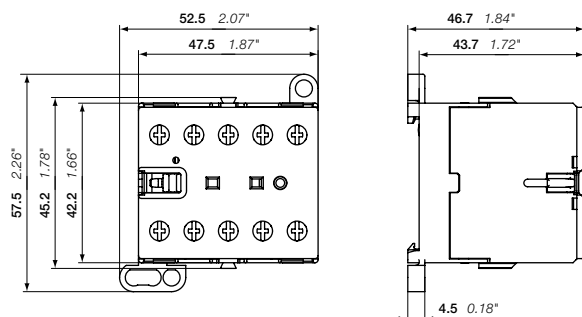

KC6

2CDC212001F0011

2CDC102013C0201

# TKC6 4-pole mini contactor relays – with screw terminals

## DC operated – large coil voltage range



2CDC211021F0011

TKC6-31Z

3

### Description

TKC6 4-pole mini contactors are space optimized control products mainly used for control functions or for small loads up to 4 A.

These contactors are designed with:

- 4-poles with various contact combinations
- control circuit: DC operated, hum free, low consumption (5 W at pull-in and at holding)
- expanded ambient temperature range -30 ... +70 °C and wide range voltage supply
- material is suitable for railway applications
- humfree operating DC coil
- no auxiliary contact block permitted for mounting
- designed for rail or wall mounting

### Ordering details

Rated control circuit voltage $U_{C \min} \dots U_{C \max}$ V DC	Type	Order code	Pkg qty	Weight (1 pce) kg
17 ... 32	TKC6-22Z-51	GJH1213061R5221	10	0.180
50 ... 90	TKC6-22Z-55	GJH1213061R5225	10	0.180
77 ... 143	TKC6-22Z-62	GJH1213061R6222	10	0.180
140 ... 260	TKC6-22Z-68	GJH1213061R6228	10	0.180
17 ... 32	TKC6-31Z-51	GJH1213061R5311	10	0.180
50 ... 90	TKC6-31Z-55	GJH1213061R5315	10	0.180
77 ... 143	TKC6-31Z-62	GJH1213061R6312	10	0.180
140 ... 260	TKC6-31Z-68	GJH1213061R6318	10	0.180
17 ... 32	TKC6-40E-51	GJH1213061R5401	10	0.180
50 ... 90	TKC6-40E-55	GJH1213061R5405	10	0.180
77 ... 143	TKC6-40E-62	GJH1213061R6402	10	0.180
140 ... 260	TKC6-40E-68	GJH1213061R6408	10	0.180

Other types on request

### Main dimensions mm, inches

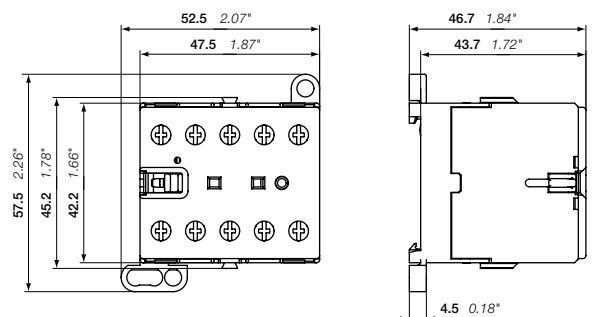

TKC6

2CDC211021F0011

2CDC102014C0201

# B6, B7, BC6, BC7 3 and 4-pole mini contactors VB6, VB7, VBC6, VBC7 3-pole mini reversing contactors Accessories



CAF6-11N

2CDC2110750010



RV-BC6/250

2CDC21100750010



CA6-11E-P

2CDC21103650010



CA6-11E

2CDC21101850011



BSM6-30

5S127792R



T16

2CDC231012F0011

## Ordering details

For contactors	Auxiliary contacts	Type	Order code	Pkg qty	Weight (1 pce)
					kg

### Front-mounted instantaneous auxiliary contact blocks (not allowed for mounting on TBC, B6S, B7S, interface contactors) (1)

B6-, B7-40-00, BC6-, BC7-40-00	1 1	CAF6-11E	GJL1201330R0002	10	0.020
VB6, VB7, VBC6, VBC7, VB6A, VB7A	2 0	CAF6-20E	GJL1201330R0006	10	0.020
VBC6A, VBC7A	0 2	CAF6-02E	GJL1201330R0010	10	0.020
B6-, B7-30-10, BC6-, BC7-30-10	1 1	CAF6-11M	GJL1201330R0003	10	0.020
VB6, VB7, VBC6, VBC7, VB6A, VB7A	2 0	CAF6-20M	GJL1201330R0007	10	0.020
VBC6A, VBC7A	0 2	CAF6-02M	GJL1201330R0011	10	0.020
B6-, B7-30-01, BC6-, BC7-30-01	1 1	CAF6-11N	GJL1201330R0004	10	0.020
VB6, VB7, VBC6, VBC7, VB6A, VB7A	2 0	CAF6-20N	GJL1201330R0008	10	0.020
VBC6A, VBC7A	0 2	CAF6-02N	GJL1201330R0012	10	0.020

### Side-mounted instantaneous auxiliary contact block (1)

B6-, B7-40-00, BC6-, BC7-40-00	1 1	CA6-11E	GJL1201317R0002	10	0.030
B6-, B7-30-10, BC6-, BC7-30-10	1 1	CA6-11M	GJL1201317R0003	10	0.030
B6-, B7-30-01, BC6-, BC7-30-01	1 1	CA6-11N	GJL1201317R0004	10	0.030

(1) CA6 and CAF6 must not be fitted simultaneously.

For contactors	Rated control circuit voltage U <sub>c</sub> V DC	Connection type	Type	Order code	Pkg qty	Weight (1 pce) kg
----------------	--	-----------------	------	------------	---------	----------------------

### Surge suppressors for contactor coils

BC6, BC7	24...60	Cable lug	RV-BC6/60	GHV2501902R0002	10	0.005
		Flat pin, 2.8 mm	RV-BC6-F/60	GHV2501902R0003	10	0.005
	50...250	Cable lug	RV-BC6/250	GHV2501903R0002	10	0.005
		Flat pin, 2.8 mm	RV-BC6-F/250	GHV2501903R0003	10	0.010
	380	Cable lug	RV-BC6/380	GHV2501904R0002	10	0.005
		Flat pin, 2.8 mm	RV-BC6-F/380	GHV2501904R0003	10	0.010

Note: Mini contactors for AC operation have an integrated protective circuit.

### Connecting links with manual motor starters

To connect B..VB.. mini contactor to MS116, MS132	BEA7/132	1SBN080906R1002	10	0.013
To connect B..VB.. mini contactors to MS325	BEA7/325	1SBN080906R1001	10	0.021

### Connection sets for reversing contactors

VB6, VB7, VBC6, VBC7, VB6A, VB7A, VBC6A, VBC7A, cross-section 1.8 mm <sup>2</sup>	BSM6-30	GJL1201908R0001	10	0.010
---	---------	-----------------	----	-------

### Parallel connecting link

B6, B7, BC6, BC7	LP6	GJL1201907R0001	100	0.009
------------------	-----	-----------------	-----	-------

### Cover cap, transparent fitting to DIN rail design, sealable

B6, B7, BC6, BC7	LT6-B	GJL1201906R0001	10	0.015
------------------	-------	-----------------	----	-------

### Overload relays fitting details (2)

Contactor types	Thermal overload relays	Electronic overload relays
B6, B7, BC6, BC7	T16 (0.10...16 A)	E16DU (0.10...18.9 A)

(2) Direct mounting - No kit required. Ordering details, see overload relays section.

# K6, KC6 4-pole mini contactor relays

## Accessories



CAF6-11K

2DCD211019S0011

3



CA6-11K

2DCD211006S0010



CA6-11K-P

2DCD211011S0010



LT6-B

2DCD211006S0010



RV-BC6/250

2DCD211007S0010

### Ordering details

For contactors	Auxiliary contacts	Type	Order code	Pkg qty	Weight (1 pce)
					kg

#### Front-mounted instantaneous auxiliary contact blocks (1)

K6, KC6	1 1	CAF6-11K	GJL1201330R0001	10	0.020
	2 0	CAF6-20K	GJL1201330R0005	10	0.020
	0 2	CAF6-02K	GJL1201330R0009	10	0.020

#### Side-mounted instantaneous auxiliary contact block (1)

K6, KC6	1 1	CA6-11K	GJL1201317R0001	10	0.030
---------	-----	---------	-----------------	----	-------

(1) CA6 and CAF6 must not be fitted simultaneously.

For contactors	Rated control circuit voltage $U_c$ V DC	Connection type	Type	Order code	Pkg qty	Weight (1 pce)
						kg

#### Surge suppressors for contactor coils

KC6	24...60	Cable lug	RV-BC6/60	GHV2501902R0002	10	0.005
		Flat pin, 2.8 mm	RV-BC6-F/60	GHV2501902R0003	10	0.005
	50...250	Cable lug	RV-BC6/250	GHV2501903R0002	10	0.005
		Flat pin, 2.8 mm	RV-BC6-F/250	GHV2501903R0003	10	0.010
	380	Cable lug	RV-BC6/380	GHV2501904R0002	10	0.005
		Flat pin, 2.8 mm	RV-BC6-F/380	GHV2501904R0003	10	0.010

Note: Mini contactors for AC operation have an integrated protective circuit.

#### Cover cap, transparent fitting to DIN rail design, sealable

K6, KC6	LT6-B	GJL1201906R0001	10	0.015
---------	-------	-----------------	----	-------

# Notes

A series of horizontal dotted lines for taking notes.

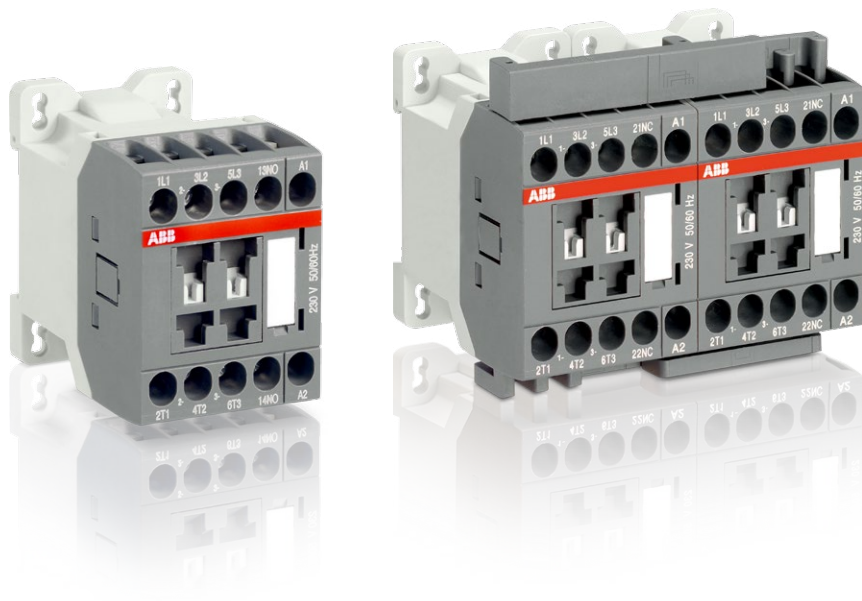

# AS 3-pole contactors and NS contactor relays with screw terminals

[Overview](#) 4/2

---

## 3-pole contactors

AS09 ... AS16	AC operated	4/4
ASL09 ... ASL16	DC operated	4/5
AS09 ... AS16	AC operated - 2-stack	4/6
ASL09 ... ASL16	DC operated - 2-stack	4/7
Main accessories		4/8

## Contactors relays

NS	AC operated	4/10
NSL	DC operated	4/11
Main accessories		4/12

[Voltage code table](#) 4/14

---

For direct product details information, use product type or order code, ex:  
[www.abb.com/productdetails/AF09-30-10-13](http://www.abb.com/productdetails/AF09-30-10-13) or [www.abb.com/productdetails/1SBL137001R1310](http://www.abb.com/productdetails/1SBL137001R1310)

# Compact Optimize your equipment dimensions!

**One frame size** for contactors up to 7.5 kW - 400 V

**Same dimensions**

for AC and DC operated contactors with screw or spring terminals

4

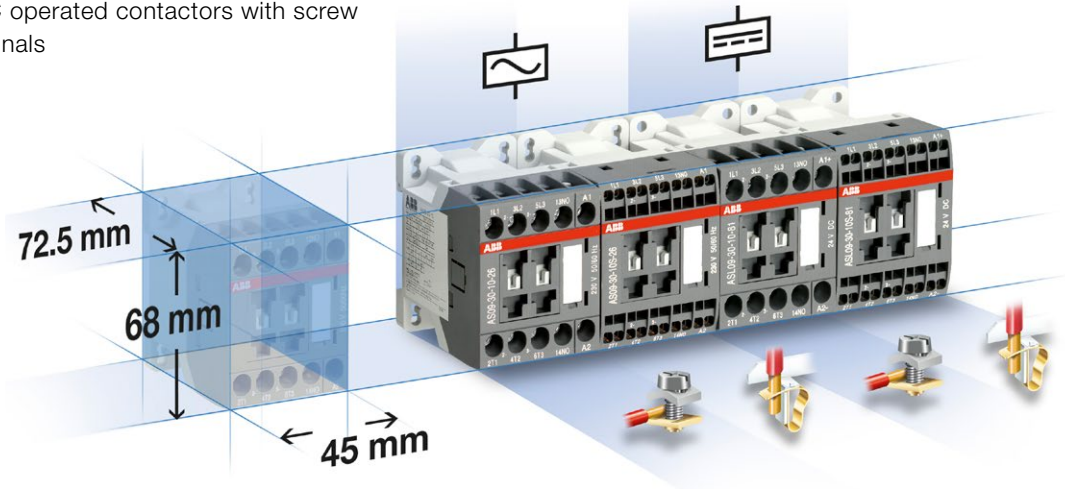

**Reversing contactors**

including mechanical and electrical interlocking without additional width

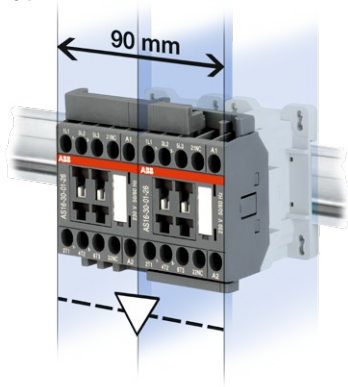

**Direct control by PLC**

removing any use of interface relay and reducing panel power consumption

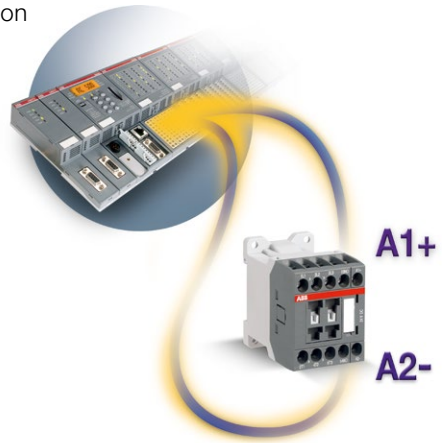

**Side clipped-on surge suppressors**

integrated into overall contactor dimensions allowing free access to coil terminals

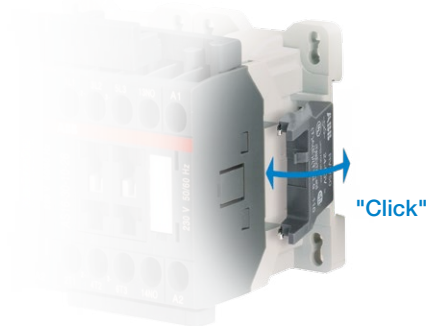

**Multiple packaging available for all products**





# Simple

## Choose reliable and time-saving solutions

### Select compact starters:

- Direct-on-line and reversing starters up to 7.5 kW – 400 V
- Star-delta starters up to 11 KW – 400 V.

### Protect your motors against short-circuits and overloads

- Type 1 or type 2 coordination guaranteed between contactors and short-circuit protection devices (manual motor starters or fuses)

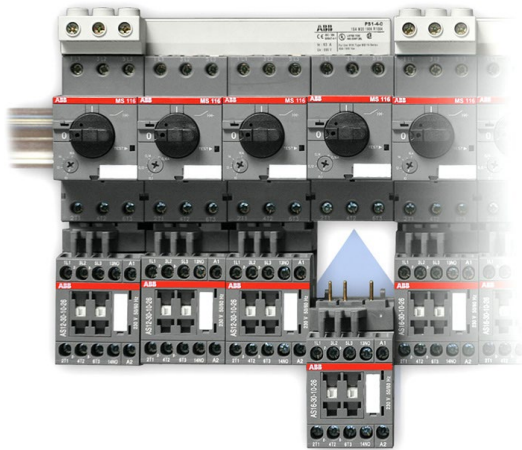

### Time/cost saving solutions with

- Connection sets for reversing and star-delta starter
- Easy, fast and secure assembly, fitting and wiring of components
- Direct 35 mm rail mounting: no additional mounting plate required
- Easy installation and dismantling of contactors: no unwiring of manual motor starters.



### Compliant to International standards Complies with RoHS European directives



### Make your control circuits safe



High reliability  
for low signals



Mechanically linked  
contacts according to  
IEC 60947-5-1  
Annex L 3.0



Mirror contact  
according to  
IEC 60947-4-1  
Annex F 2.1

### Time and space-saving solutions, suitable for your applications

- Escalators
- Elevators
- Conveyors
- Compressors
- Door control
- Hvac
- Pumps
- Washing machines...

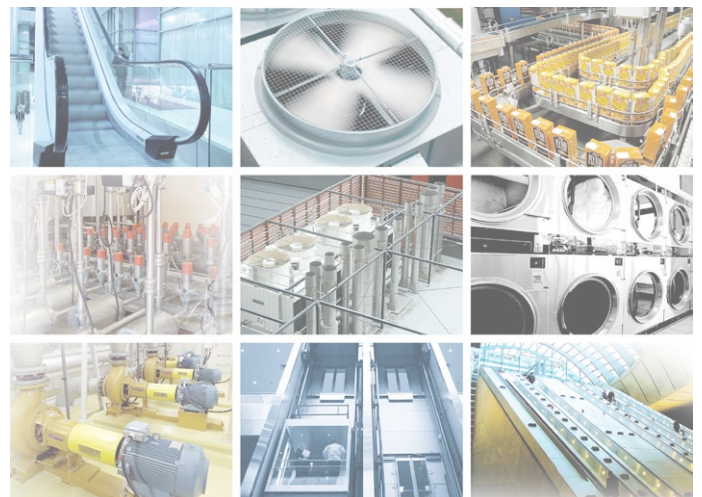

# AS09 ... AS16 3-pole contactors

## 4 to 7.5 kW

### AC operated



AS09-30-10

4

#### Description

AS09 ... AS16 contactors are mainly used for controlling 3-phase motors and power circuits up to 690 V AC and 220 V DC.

These contactors are of the block type design with:

- 3 main poles and 1 built-in auxiliary contact
- control circuit: AC operated
- add-on auxiliary contact blocks for front mounting and a comprehensive range of accessories.

#### Ordering details

IEC Rated operational power 400 V AC-3 kW	Rated operational current $\theta \leq 40^\circ\text{C}$ AC-1 A	UL/CSA 3-phase motor rating 480 V hp	General use rating 600 V AC A	Rated control circuit voltage Uc (1)		Auxiliary contacts fitted 	Type	Order code	Weight Pkg (1 pce) kg				
				V 50 Hz	V 60 Hz								
4	22	5	20	24	24	1 0	AS09-30-10-20	1SBL101001R2010	0.220				
						0 1	AS09-30-01-20	1SBL101001R2001	0.220				
				-	120	1 0	AS09-30-10-16	1SBL101001R1610	0.220				
						0 1	AS09-30-01-16	1SBL101001R1601	0.220				
				230	230	1 0	AS09-30-10-26	1SBL101001R2610	0.220				
						0 1	AS09-30-01-26	1SBL101001R2601	0.220				
				400	400	1 0	AS09-30-10-28	1SBL101001R2810	0.220				
						0 1	AS09-30-01-28	1SBL101001R2801	0.220				
				5.5	24	7.5	20	24	24	1 0	AS12-30-10-20	1SBL111001R2010	0.220
										0 1	AS12-30-01-20	1SBL111001R2001	0.220
-	120	1 0	AS12-30-10-16					1SBL111001R1610	0.220				
		0 1	AS12-30-01-16					1SBL111001R1601	0.220				
230	230	1 0	AS12-30-10-26					1SBL111001R2610	0.220				
		0 1	AS12-30-01-26					1SBL111001R2601	0.220				
400	400	1 0	AS12-30-10-28					1SBL111001R2810	0.220				
		0 1	AS12-30-01-28					1SBL111001R2801	0.220				
7.5	24	10	20					24	24	1 0	AS16-30-10-20	1SBL121001R2010	0.220
										0 1	AS16-30-01-20	1SBL121001R2001	0.220
				-	120	1 0	AS16-30-10-16	1SBL121001R1610	0.220				
						0 1	AS16-30-01-16	1SBL121001R1601	0.220				
				230	230	1 0	AS16-30-10-26	1SBL121001R2610	0.220				
						0 1	AS16-30-01-26	1SBL121001R2601	0.220				
				400	400	1 0	AS16-30-10-28	1SBL121001R2810	0.220				
						0 1	AS16-30-01-28	1SBL121001R2801	0.220				

Note: for multiple packaging, please contact your ABB local sales organization.

(1) Other control voltages see voltage code table.

#### Main dimensions mm, inches

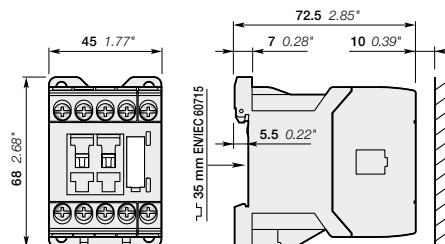

AS09, AS12, AS16

# ASL09 ... ASL16 3-pole contactors

## 4 to 7.5 kW

### DC operated



ASL09-30-10

#### Description

ASL09 ... ASL16 contactors are mainly used for controlling 3-phase motors and power circuits up to 690 V AC and 220 V DC.

These contactors are of the block type design with:

- 3 main poles and 1 built-in auxiliary contact
- control circuit: low consumption (3 W at pull-in and holding) DC operated with solid core magnet. Suitable for direct control by PLC outputs (the polarity on the coil terminals A1+ and A2- must be respected)
- add-on auxiliary contact blocks for front mounting and a comprehensive range of accessories.

#### Ordering details

IEC Rated operational power	UL/CSA 3-phase motor rating 480 V	General use rating 600 V AC	Rated control circuit voltage Uc (1)	Auxiliary contacts fitted	Type	Order code	Weight Pkg (1 pce)							
								400 V AC-3 kW	AC-1 A	hp	A	V DC	kg	
4	22	5	20	24	1 0	ASL09-30-10-81	1SBL103001R8110	0.280						
						0 1	ASL09-30-01-81	1SBL103001R8101	0.280					
					48	1 0	ASL09-30-10-83	1SBL103001R8310	0.280					
							0 1	ASL09-30-01-83	1SBL103001R8301	0.280				
						1 0	ASL09-30-10-86	1SBL103001R8610	0.280					
							0 1	ASL09-30-01-86	1SBL103001R8601	0.280				
					220	1 0	ASL09-30-10-88	1SBL103001R8810	0.280					
							0 1	ASL09-30-01-88	1SBL103001R8801	0.280				
					5.5	24	7.5	20	24	1 0	ASL12-30-10-81	1SBL113001R8110	0.280	
											0 1	ASL12-30-01-81	1SBL113001R8101	0.280
										48	1 0	ASL12-30-10-83	1SBL113001R8310	0.280
												0 1	ASL12-30-01-83	1SBL113001R8301
1 0	ASL12-30-10-86	1SBL113001R8610	0.280											
	0 1	ASL12-30-01-86	1SBL113001R8601	0.280										
220	1 0	ASL12-30-10-88	1SBL113001R8810	0.280										
		0 1	ASL12-30-01-88	1SBL113001R8801						0.280				
7.5	24	10	20	24						1 0	ASL16-30-10-81	1SBL123001R8110	0.280	
											0 1	ASL16-30-01-81	1SBL123001R8101	0.280
										48	1 0	ASL16-30-10-83	1SBL123001R8310	0.280
												0 1	ASL16-30-01-83	1SBL123001R8301
					1 0	ASL16-30-10-86	1SBL123001R8610	0.280						
						0 1	ASL16-30-01-86	1SBL123001R8601	0.280					
					220	1 0	ASL16-30-10-88	1SBL123001R8810	0.280					
							0 1	ASL16-30-01-88	1SBL123001R8801	0.280				

Note: for multiple packaging, please contact your ABB local sales organization.

(1) Other control voltages see voltage code table.

#### Main dimensions mm, inches

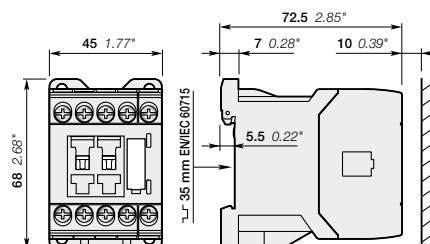

ASL09, ASL12, ASL16

# AS09 ... AS16 2-stack 3-pole contactors

## 4 to 7.5 kW

### AC operated



AS09-30-32

#### Description

AS09 ... AS16 contactors are mainly used for controlling 3-phase motors and power circuits up to 690 V AC and 220 V DC.

These contactors are of the block type design with:

- 1st stack with 3 main poles and 1 N.O. built-in auxiliary contact
- 2nd stack with permanently fixed 2 N.O. + 2 N.C. auxiliary contact block. The auxiliary contact elements are mechanically linked (side-marked symbol) and the N.C. auxiliary contacts are mirror contacts
- control circuit: AC operated
- a comprehensive range of accessories.

#### Ordering details

IEC Rated operational power 400 V AC-3 kW	UL/CSA 3-phase motor rating 480 V hp	General use rating 600 V AC A	Rated control circuit voltage Uc (1)		Auxiliary contacts fitted	Type	Order code	Weight Pkg (1 pce) kg	
			V 50 Hz	V 60 Hz					
4	22	5	20	24	24	3 2	AS09-30-32-20	1SBL101001R2032	0.260
				-	120	3 2	AS09-30-32-16	1SBL101001R1632	0.260
				230	230	3 2	AS09-30-32-26	1SBL101001R2632	0.260
				400	400	3 2	AS09-30-32-28	1SBL101001R2832	0.260
5.5	24	7.5	20	24	24	3 2	AS12-30-32-20	1SBL111001R2032	0.260
				-	120	3 2	AS12-30-32-16	1SBL111001R1632	0.260
				230	230	3 2	AS12-30-32-26	1SBL111001R2632	0.260
				400	400	3 2	AS12-30-32-28	1SBL111001R2832	0.260
7.5	24	10	20	24	24	3 2	AS16-30-32-20	1SBL121001R2032	0.260
				-	120	3 2	AS16-30-32-16	1SBL121001R1632	0.260
				230	230	3 2	AS16-30-32-26	1SBL121001R2632	0.260
				400	400	3 2	AS16-30-32-28	1SBL121001R2832	0.260

Note: for multiple packaging, please contact your ABB local sales organization.

(1) Other control voltages see voltage code table.

#### Main dimensions mm, inches

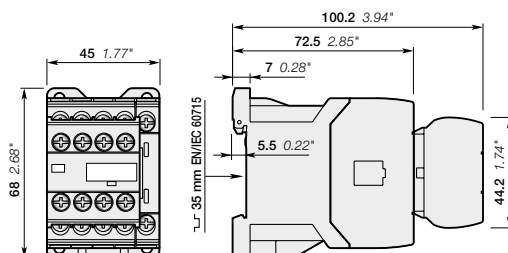

AS09, AS12, AS16

# ASL09 ... ASL16 2-stack 3-pole contactors

## 4 to 7.5 kW

### DC operated



ASL09-30-32



#### Description

ASL09 ... ASL16 contactors are mainly used for controlling 3-phase motors and power circuits up to 690 V AC and 220 V DC.

These contactors are of the block type design with:

- 1st stack with 3 main poles and 1 N.O. built-in auxiliary contact
- 2nd stack with permanently fixed 2 N.O. + 2 N.C. auxiliary contact block. The auxiliary contact elements are mechanically linked (side-marked symbol) and the N.C. auxiliary contacts are mirror contacts
- control circuit: low consumption (3 W at pull-in and holding) DC operated with solid core magnet. Suitable for direct control by PLC outputs (the polarity on the coil terminals A1+ and A2- must be respected)
- a comprehensive range of accessories.

#### Ordering details

IEC		UL/CSA		Rated control circuit voltage Uc (1)	Auxiliary contacts fitted	Type	Order code	Weight
Rated power	operational current $\theta \leq 40^\circ\text{C}$	3-phase motor rating 480 V	General use rating 600 V AC					
400 V AC-3 kW	AC-1 A	hp	A	V DC	 			kg
4	22	5	20	24	3 2	ASL09-30-32-81	1SBL103001R8132	0.320
				48	3 2	ASL09-30-32-83	1SBL103001R8332	0.320
				110	3 2	ASL09-30-32-86	1SBL103001R8632	0.320
				220	3 2	ASL09-30-32-88	1SBL103001R8832	0.320
5.5	24	7.5	20	24	3 2	ASL12-30-32-81	1SBL113001R8132	0.320
				48	3 2	ASL12-30-32-83	1SBL113001R8332	0.320
				110	3 2	ASL12-30-32-86	1SBL113001R8632	0.320
				220	3 2	ASL12-30-32-88	1SBL113001R8832	0.320
7.5	24	10	20	24	3 2	ASL16-30-32-81	1SBL123001R8132	0.320
				48	3 2	ASL16-30-32-83	1SBL123001R8332	0.320
				110	3 2	ASL16-30-32-86	1SBL123001R8632	0.320
				220	3 2	ASL16-30-32-88	1SBL123001R8832	0.320

Note: for multiple packaging, please contact your ABB local sales organization.

(1) Other control voltages see voltage code table.

#### Main dimensions mm, inches

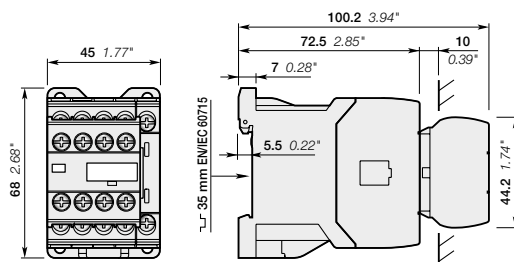

ASL09, ASL12, ASL16

# AS09 ... AS16 and ASL09 ... ASL16 3-pole contactors

## Main accessories

Contactor and main accessories (other accessories available)

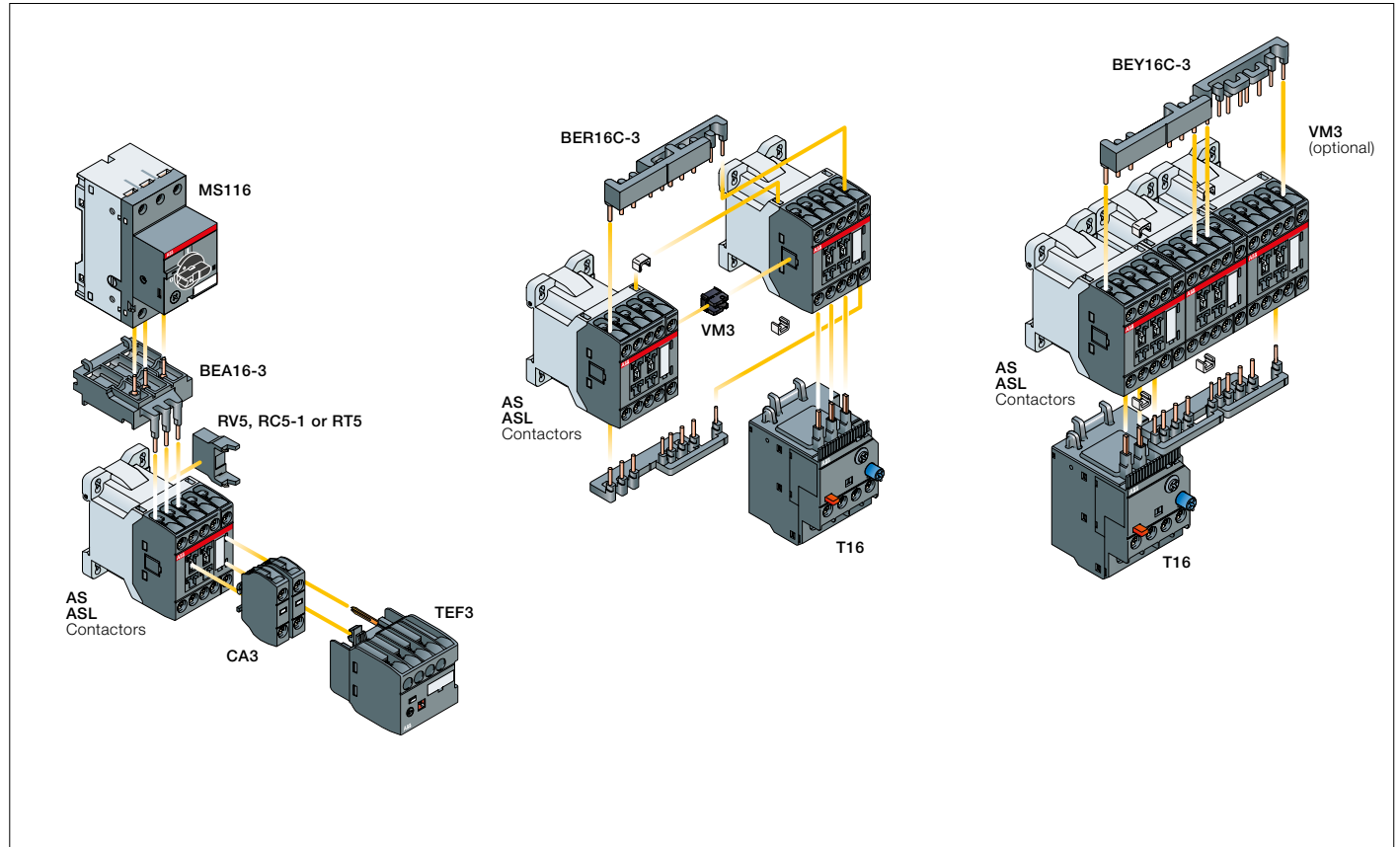

### Main accessory fitting details

Many configurations of accessories are possible depending on whether these are front-mounted or side-mounted.

Contactor types	Main poles	Built-in auxiliary contacts	Front-mounted accessories			Side-mounted accessories			
			Auxiliary contact blocks	Electronic timer	Mechanical interlock unit (between 2 contactors)	Surge suppressors			
AS09 ... AS16	3 0	1 0	1-pole CA3	TEF3	VM3	+	RV5	or	RC5-1
			2 max.	or 1	+	+	+	+	
AS09 ... AS16	3 0	3 2	-	-	1	+	RV5	or	RC5-1
ASL09 ... ASL16	3 0	1 0	1-pole CA3	TEF3	VM3	+	RV5	or	RT5
			2 max.	or 1	+	+	+	+	
ASL09 ... ASL16	3 0	3 2	-	-	1	+	RV5	or	RT5

### Overload relays fitting details (1)

Contactor types	Thermal overload relays
AS09 ... AS16	T16 (0.10...16 A)
ASL09 ... ASL16	

The addition of an overload relay on the contactor does not prevent fitting of many other accessories as shown above.

(1) Direct mounting - No kit required.

# AS09 ... AS16 and ASL09 ... ASL16 3-pole contactors

## Main accessories



CA3-10

### Front-mounted instantaneous auxiliary contact blocks

For contactors	Auxiliary contacts	Type	Order code	Pkg qty	Weight (1 pce) kg
AS09 ... AS16	1 0	CA3-10	1SBN011010T1010	10	0.011
ASL09 ... ASL16	0 1	CA3-01	1SBN011010T1001	10	0.011



TEF3-ON

### Front-mounted electronic timer

For contactors	Rated control circuit voltage - U <sub>c</sub> V	Type	Order code	Pkg qty	Weight (1 pce) kg
<b>ON-delay</b>					
AS09 ... AS16, ASL09 ... ASL16	24...240 V AC/DC	TEF3-ON	1SBN021012R1000	1	0.065
<b>OFF-delay</b>					
AS09 ... AS16, ASL09 ... ASL16	24...240 V AC/DC	TEF3-OFF	1SBN021014R1000	1	0.065



VM3

### Mechanical interlock unit

For contactors	Type	Order code	Pkg qty	Weight (1 pce) kg
AS09 ... AS16, ASL09 ... ASL16	VM3	1SBN031005T1000	10	0.002



RV5

### Surge suppressors

For contactors	Rated control circuit voltage - U <sub>c</sub>		Type	Order code	Pkg qty	Weight (1 pce) kg
	V	AC DC				
AS09 ... AS16, ASL09 ... ASL16	24...50	● ●	RV5/50	1SBN050010R1000	2	0.015
	50...133	● ●	RV5/133	1SBN050010R1001	2	0.015
	110...250	● ●	RV5/250	1SBN050010R1002	2	0.015
	250...440	● ●	RV5/440	1SBN050010R1003	2	0.015
AS09 ... AS16	24...50	● -	RC5-1/50	1SBN050100R1000	2	0.012
	50...133	● -	RC5-1/133	1SBN050100R1001	2	0.012
	110...250	● -	RC5-1/250	1SBN050100R1002	2	0.012
	250...440	● -	RC5-1/440	1SBN050100R1003	2	0.012
ASL09 ... ASL16	12...32	- ●	RT5/32	1SBN050020R1000	2	0.015
	25...65	- ●	RT5/65	1SBN050020R1001	2	0.015
	50...90	- ●	RT5/90	1SBN050020R1002	2	0.015
	77...150	- ●	RT5/150	1SBN050020R1003	2	0.015
	150...264	- ●	RT5/264	1SBN050020R1004	2	0.015



BEA16-3

### Connecting links with manual motor starters

For contactors	Manual motor starter	Type	Order code	Pkg qty	Weight (1 pce) kg
AS09 ... AS16	MS116-0.16 ... MS116-16	BEA16-3	1SBN081006T1000	10	0.019
ASL09 ... ASL16	MS132-0.16 ... MS132-16				

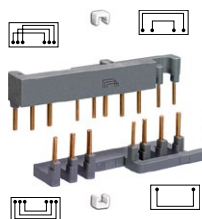

BER16C-3

### Connection sets for reversing contactors

For contactors	Mechanical interlock unit	Type	Order code	Pkg qty	Weight (1 pce) kg
AS09 ... AS16, ASL09 ... ASL16	with or without VM3	BER16C-3	1SBN081012R1000	1	0.035

Note: BER16C-3 connection set includes two BB3 fixing clips, and an electrical interlocking when fitted on contactors with built-in N.C. auxiliary contacts. BER16C-3 can be used with or without VM3 mechanical interlock unit.

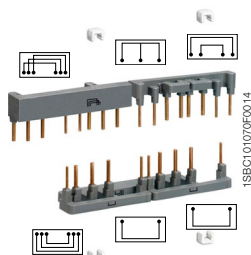

BEY16C-3

### Connection sets for star-delta starting

For contactors	Mech. interlock unit between Star & Delta contactors	Type	Order code	Pkg qty	Weight (1 pce) kg
AS09 ... AS12, ASL09 ... ASL12	with or without VM3	BEY16C-3	1SBN081018R2000	1	0.041

Note: BEY16C-3 connection set includes two BB3 fixing clips, and an electrical interlocking when fitted on Star and Delta contactors with built-in N.C. auxiliary contacts. BEY16C-3 can be used with or without VM3 mechanical interlock unit.

# NS contactor relays

## AC operated



NS22E

### Description

NS contactor relays are used for switching auxiliary and control circuits.

These contactor relays are designed with:

- 4 poles or 8 poles. Contactor relays have mechanically linked auxiliary contact elements (side-marked symbol)
- control circuit: AC operated
- add-on auxiliary contact blocks for front mounting and a comprehensive range of accessories.

### Ordering details

Number of contacts 1st stack	2nd stack	Rated control circuit voltage Uc (1)		Type	Order code	Weight  Pkg (1 pce) kg
		V 50 Hz	V 60 Hz			
		24	24	NS22E-20	1SBH101001R2022	0.220
		-	120	NS22E-16	1SBH101001R1622	0.220
		230	230	NS22E-26	1SBH101001R2622	0.220
		400	400	NS22E-28	1SBH101001R2822	0.220
		-	120	NS31E-16	1SBH101001R1631	0.220
		230	230	NS31E-26	1SBH101001R2631	0.220
		400	400	NS31E-28	1SBH101001R2831	0.220
		-	120	NS40E-16	1SBH101001R1640	0.220
		230	230	NS40E-26	1SBH101001R2640	0.220
		400	400	NS40E-28	1SBH101001R2840	0.220
		-	120	NS44E-16	1SBH101001R1644	0.260
		230	230	NS44E-26	1SBH101001R2644	0.260
		400	400	NS44E-28	1SBH101001R2844	0.260
		-	120	NS53E-16	1SBH101001R1653	0.260
		230	230	NS53E-26	1SBH101001R2653	0.260
		400	400	NS53E-28	1SBH101001R2853	0.260
		-	120	NS62E-16	1SBH101001R1662	0.260
		230	230	NS62E-26	1SBH101001R2662	0.260
		400	400	NS62E-28	1SBH101001R2862	0.260
		-	120	NS71E-16	1SBH101001R1671	0.260
		230	230	NS71E-26	1SBH101001R2671	0.260
		400	400	NS71E-28	1SBH101001R2871	0.260
		-	120	NS80E-16	1SBH101001R1680	0.260
		230	230	NS80E-26	1SBH101001R2680	0.260
		400	400	NS80E-28	1SBH101001R2880	0.260

Note: for multiple packaging, please contact your ABB local sales organization.

(1) Other control voltages see voltage code table.

### Main dimensions mm, inches

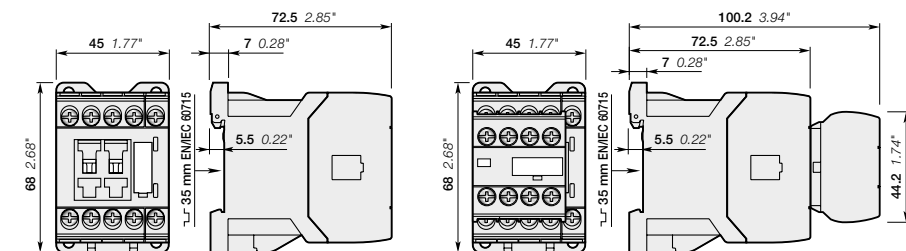

NS22E, NS31E, NS40E

NS44E, NS53E, NS62E, NS71E, NS80E

1SBC101475S0201



# NSL contactor relays

## DC operated



NSL22E

### Description

NSL contactor relays are used for switching auxiliary and control circuits.

These contactor relays are designed with:

- 4 poles or 8 poles. Contactor relays have mechanically linked auxiliary contact elements (side-marked symbol)
- control circuit: low coil consumption (3 W at pull-in and holding) DC operated with solid core magnet. Suitable for direct control by PLC outputs (the polarity on the coil terminals A1+ and A2- must be respected)
- add-on auxiliary contact blocks for front mounting and a comprehensive range of accessories.

### Ordering details

Number of contacts 1st stack	2nd stack	Rated control circuit voltage U <sub>c</sub> (1) V DC	Type	Order code	Weight
					Pkg (1 pce) kg
		24	NSL22E-81	1SBH103001R8122	0.280
		48	NSL22E-83	1SBH103001R8322	0.280
		110	NSL22E-86	1SBH103001R8622	0.280
		220	NSL22E-88	1SBH103001R8822	0.280
		24	NSL31E-81	1SBH103001R8131	0.280
		48	NSL31E-83	1SBH103001R8331	0.280
		110	NSL31E-86	1SBH103001R8631	0.280
		220	NSL31E-88	1SBH103001R8831	0.280
		24	NSL40E-81	1SBH103001R8140	0.280
		48	NSL40E-83	1SBH103001R8340	0.280
		110	NSL40E-86	1SBH103001R8640	0.280
		220	NSL40E-88	1SBH103001R8840	0.280
		24	NSL44E-81	1SBH103001R8144	0.320
		48	NSL44E-83	1SBH103001R8344	0.320
		110	NSL44E-86	1SBH103001R8644	0.320
		220	NSL44E-88	1SBH103001R8844	0.320
		24	NSL53E-81	1SBH103001R8153	0.320
		48	NSL53E-83	1SBH103001R8353	0.320
		110	NSL53E-86	1SBH103001R8653	0.320
		220	NSL53E-88	1SBH103001R8853	0.320
		24	NSL62E-81	1SBH103001R8162	0.320
		48	NSL62E-83	1SBH103001R8362	0.320
		110	NSL62E-86	1SBH103001R8662	0.320
		220	NSL62E-88	1SBH103001R8862	0.320
		24	NSL71E-81	1SBH103001R8171	0.320
		48	NSL71E-83	1SBH103001R8371	0.320
		110	NSL71E-86	1SBH103001R8671	0.320
		220	NSL71E-88	1SBH103001R8871	0.320
		24	NSL80E-81	1SBH103001R8180	0.320
		48	NSL80E-83	1SBH103001R8380	0.320
		110	NSL80E-86	1SBH103001R8680	0.320
		220	NSL80E-88	1SBH103001R8880	0.320

Note: for multiple packaging, please contact your ABB local sales organization.

(1) Other control voltages see voltage code table.

### Main dimensions mm, inches

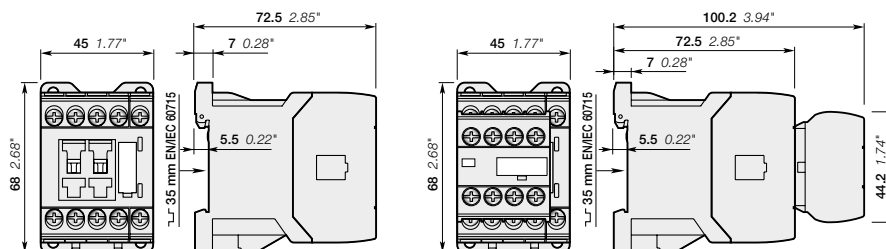

NSL22E, NSL31E, NSL40E

NSL44E, NSL53E, NSL62E, NSL71E, NSL80E

1SBC101479S0201

# NS and NSL contactor relays

## Main accessories

### Contactor relays and main accessories (other accessories available)

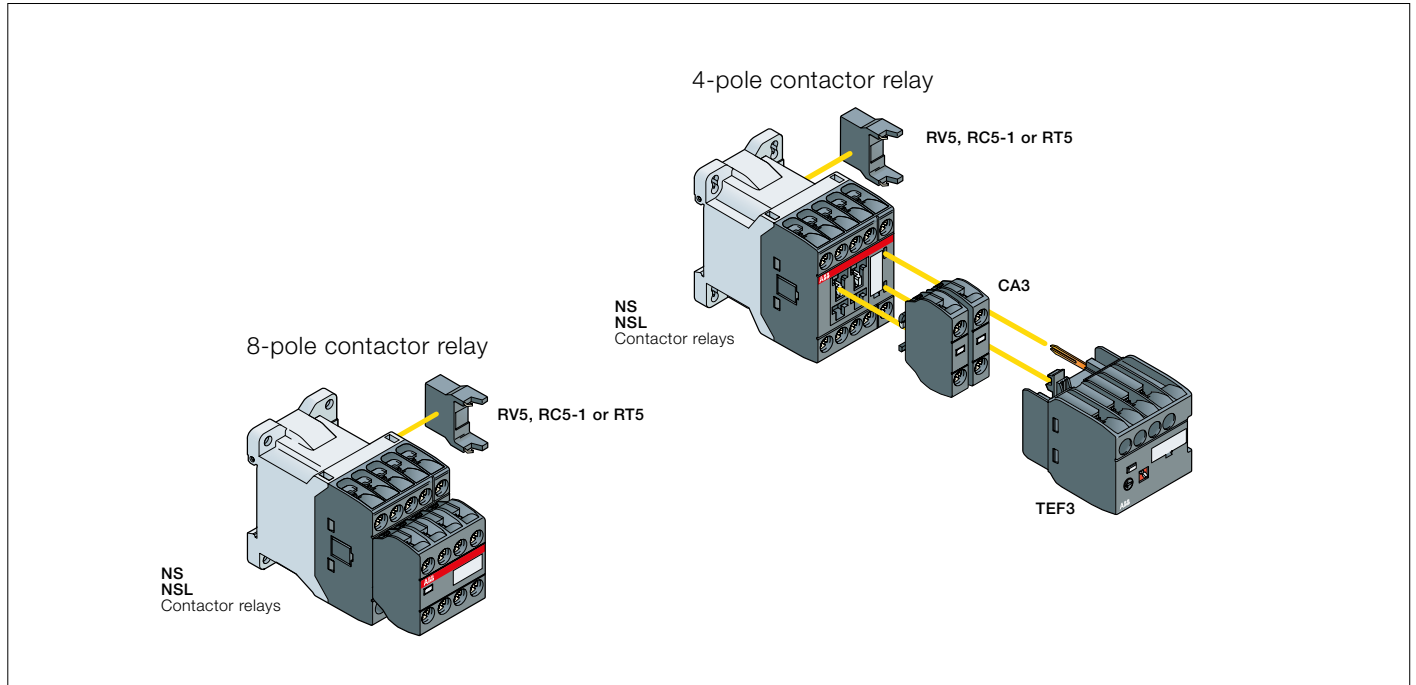

### Main accessory fitting details

Contactor types	Main poles	Front-mounted accessories		Side-mounted accessories	
		Auxiliary contact blocks	Electronic timer	Surge suppressors	
		1-pole CA3	TEF3		
NS..	2 2 E	2 max.	or 1	+	RV5 or RC5-1
NS..	3 1 E				
NS..	4 0 E				
NS..	4 4 E	-	-		RV5 or RC5-1
NS..	5 3 E				
NS..	6 2 E				
NS..	7 1 E				
NS..	8 0 E				
NSL..	2 2 E	2 max.	or 1	+	RV5 or RT5
NSL..	3 1 E				
NSL..	4 0 E				
NSL..	4 4 E	-	-		RV5 or RT5
NSL..	5 3 E				
NSL..	6 2 E				
NSL..	7 1 E				
NSL..	8 0 E				

# NS and NSL contactor relays

## Main accessories



CA3-10





TEF3-ON



RV5

### Front-mounted instantaneous auxiliary contact blocks

For contactor relays	Auxiliary contacts	Type	Order code	Pkg qty	Weight (1 pce)
	 				kg
NS, NSL	1 0	CA3-10	1SBN011010T1010	10	0.011
	0 1	CA3-01	1SBN011010T1001	10	0.011

### Front-mounted electronic timer

For contactors	Rated control circuit voltage - U <sub>c</sub> V	Type	Order code	Pkg qty	Weight (1 pce)
<b>ON-delay</b>					
NS, NSL	24...240 V AC/DC	TEF3-ON	1SBN021012R1000	1	0.065
<b>OFF-delay</b>					
NS, NSL	24...240 V AC/DC	TEF3-OFF	1SBN021014R1000	1	0.065

### Surge suppressors

For contactor relays	Rated control circuit voltage - U <sub>c</sub>		Type	Order code	Pkg qty	Weight (1 pce)	
	V	AC					DC
NS, NSL	24...50	●	●	RV5/50	1SBN050010R1000	2	0.015
	50...133	●	●	RV5/133	1SBN050010R1001	2	0.015
	110...250	●	●	RV5/250	1SBN050010R1002	2	0.015
	250...440	●	●	RV5/440	1SBN050010R1003	2	0.015
NS	24...50	●	-	RC5-1/50	1SBN050100R1000	2	0.012
	50...133	●	-	RC5-1/133	1SBN050100R1001	2	0.012
	110...250	●	-	RC5-1/250	1SBN050100R1002	2	0.012
	250...440	●	-	RC5-1/440	1SBN050100R1003	2	0.012
NSL	12...32	-	●	RT5/32	1SBN050020R1000	2	0.015
	25...65	-	●	RT5/65	1SBN050020R1001	2	0.015
	50...90	-	●	RT5/90	1SBN050020R1002	2	0.015
	77...150	-	●	RT5/150	1SBN050020R1003	2	0.015
	150...264	-	●	RT5/264	1SBN050020R1004	2	0.015

# Voltage code table

The below tables indicate the available coil voltages and corresponding digits for order codes. When placing an order, please give either type or order code. Select a standard contactor from ordering detail pages. Change the **coil voltage code** in the type or in the order code according to the table below. Example: for contactor AS09-30-10 and coil 42 V 50/60 Hz, type is AS09-30-10-21 and order code is 1SBL101001R2110.

## 3-pole contactors

**Type**

AS16 - 30 - 10 - 26

Auxiliary contacts  
N.O. N.C.

Main contacts  
N.O. N.C.

**Contactor type**  
AS AC operated  
ASL DC operated

**Order code**

1SBL121001R 26 10

**AC coil code**

	50 Hz	60 Hz
20	24 V	24 V
21	42 V	42 V
22	48 V	48 V
23	110 V	110 V
24	115 V	115 V
16	-	120 V
25	220 V	220 V
26	230 V	230 V
27	240 V	240 V
17	-	277 V
13	380 V	-
28	400 V	400 V
29	415 V	415 V

**DC coil code**

80	12 V
81	24 V
83	48 V
84	60 V
86	110 V
87	125 V
88	220 V
89	240 V

## 3-pole reversing contactors

**Type**

VAS12 S EM - 26 M

Surge suppressor

**Contactor type**  
VAS AC operated  
VASL DC operated

**Order code**

1SBK113800M 26 00

**AC coil code**

	50 Hz	60 Hz
20	24 V	24 V
21	42 V	42 V
22	48 V	48 V
23	110 V	110 V
24	115 V	115 V
16	-	120 V
25	220 V	220 V
26	230 V	230 V
27	240 V	240 V
17	-	277 V
13	380 V	-
28	400 V	400 V
29	415 V	415 V

**DC coil code**

80	12 V (1)
81	24 V
83	48 V
84	60 V
86	110 V
87	125 V
88	220 V
89	240 V

(1) Not for VASL..SEM

## Contactor relays

**Type**

NS 40 E - 26

N.O. N.C.  
Number contacts

**Contactor type**  
NS AC operated  
NSL DC operated

**Order code**

1SBH101001R 26 40

**AC coil code**

	50 Hz	60 Hz
20	24 V	24 V
21	42 V	42 V
22	48 V	48 V
23	110 V	110 V
24	115 V	115 V
16	-	120 V
25	220 V	220 V
26	230 V	230 V
27	240 V	240 V
17	-	277 V
13	380 V	-
28	400 V	400 V
29	415 V	415 V

**DC coil code**

80	12 V
81	24 V
83	48 V
84	60 V
86	110 V
87	125 V
88	220 V
89	240 V

# DRAS09 ... DRAS16 enclosed direct-on-line starters

## 4 to 7.5 kW, protected by thermal overload relays

### AC or DC operated

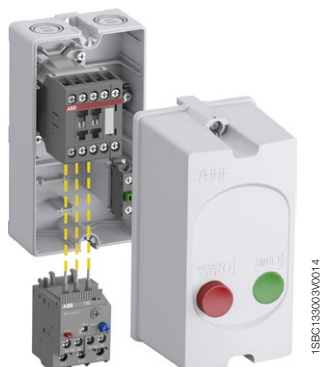

DRAS  
+ T16 to be ordered separately

#### Description

Enclosed direct-on-line (DOL) starters are used for controlling 3-phase asynchronous motors up to 690 V AC.

Each starter is delivered assembled and wired. It contains:

- IP65 compact plastic enclosure with double insulation, equipped with:
  - 1 green flush "I" ON button and 1 red protruding "O" OFF/RESET button
  - 2 quarter-turn, quick fastening screws and a base with 6 cable inlets and outlets via knockouts.
- 1 AS or ASL 3-pole contactor with holding contact
- 1 PE and 1 neutral terminal.

3 versions of control supply wiring are available: phase-to-phase, separate supply or phase-to-neutral.

T16 thermal overload relay has to be ordered separately and chosen according to motor's nominal current (see table below).

#### DRAS, DRASL enclosed DOL starters

IEC - AC-3				Rated control circuit voltage U <sub>c</sub> Other control voltages see AS voltage code table	Control supply wiring	Type	Order code	Weight Pkg (1 pce) kg
Rated operational power 220 V 230 V 240 V	400 V	500 V	max. current θ ≤ 40 °C U <sub>e</sub> =400 V					
kW	kW	kW	A	V 50/60 Hz	V DC			

#### AC operated with AS 3-pole contactors

2.2	4	4	9	24	-	Separate supply	DRAS09-20S	1SBK104235R2000	0.650
				230	-	Phase-to-neutral	DRAS09-26N	1SBK104135R2600	0.650
				240	-	Phase-to-neutral	DRAS09-27N	1SBK104135R2700	0.650
				400	-	Phase-to-phase	DRAS09-28P	1SBK104035R2800	0.650
				415	-	Phase-to-phase	DRAS09-29P	1SBK104035R2900	0.650
3	5.5	5.5	12	24	-	Separate supply	DRAS12-20S	1SBK114235R2000	0.650
				230	-	Phase-to-neutral	DRAS12-26N	1SBK114135R2600	0.650
				240	-	Phase-to-neutral	DRAS12-27N	1SBK114135R2700	0.650
				400	-	Phase-to-phase	DRAS12-28P	1SBK114035R2800	0.650
				415	-	Phase-to-phase	DRAS12-29P	1SBK114035R2900	0.650
4	7.5	7.5	15.5	24	-	Separate supply	DRAS16-20S	1SBK124235R2000	0.650
				230	-	Phase-to-neutral	DRAS16-26N	1SBK124135R2600	0.650
				240	-	Phase-to-neutral	DRAS16-27N	1SBK124135R2700	0.650
				400	-	Phase-to-phase	DRAS16-28P	1SBK124035R2800	0.650
				415	-	Phase-to-phase	DRAS16-29P	1SBK124035R2900	0.650

#### DC operated with ASL 3-pole contactors

2.2	4	4	9	-	24	Separate supply	DRASL09-81S	1SBK104335R8100	0.700
				-	48		DRASL09-83S	1SBK104335R8300	0.700
3	5.5	5.5	12	-	24	Separate supply	DRASL12-81S	1SBK114335R8100	0.700
				-	48		DRASL12-83S	1SBK114335R8300	0.700
4	7.5	7.5	15.5	-	24	Separate supply	DRASL16-81S	1SBK124335R8100	0.700
				-	48		DRASL16-83S	1SBK124335R8300	0.700

#### T16 thermal overload relays to be ordered separately

Setting range	Short-circuit protective device	Trip class	Type	Order code	Weight (1 pce) kg
A	0.5 A, Fuse type T	10	T16-0.13	1SAZ711201R1005	0.100
			T16-0.17	1SAZ711201R1008	0.100
			T16-0.23	1SAZ711201R1009	0.100
0.23...0.31	2.0 A, Fuse type gG		T16-0.31	1SAZ711201R1013	0.100
			T16-0.41	1SAZ711201R1014	0.100
			T16-0.55	1SAZ711201R1017	0.100
0.55...0.74	4.0 A, Fuse type gG		T16-0.74	1SAZ711201R1021	0.100
			T16-1.0	1SAZ711201R1023	0.100
1.00...1.30	6.0 A, Fuse type gG		T16-1.3	1SAZ711201R1025	0.100
			T16-1.7	1SAZ711201R1028	0.100
1.70...2.30	10.0 A, Fuse type gG		T16-2.3	1SAZ711201R1031	0.100
			T16-3.1	1SAZ711201R1033	0.100
2.30...3.10	20.0 A, Fuse type gG		T16-4.2	1SAZ711201R1035	0.100
			T16-5.7	1SAZ711201R1038	0.100
3.10...4.20	35.0 A, Fuse type gG		T16-7.6	1SAZ711201R1040	0.100
			T16-10	1SAZ711201R1043	0.104
4.20...5.70	40.0 A, Fuse type gG		T16-13	1SAZ711201R1045	0.104
			T16-16	1SAZ711201R1047	0.104



T16



Empty enclosure  
with push-button

#### Empty enclosure with push-button

-	-	-	FR16AS-12VARS	1SBN101035R1000	0.394
---	---	---	---------------	-----------------	-------

To be completed with AS or ASL contactor, T16 thermal overload relay and MCB-10B (1SFA611610R2001) contact block.



# AF, EK contactors and NF contactor relays

## Motor starting solution, in kit form

DOL and reversing starters protected by manual motor starters	6/2
DOL starters protected by moulded-case circuit-breakers	6/8
DOL and reversing starters protected by overload relays	6/14
Star-delta starters protected by overload relays	6/20

## AF 3-pole contactors - Overview 6/26

### 4 to 45 kW / 5 to 60 hp

AF09 ... AF38	AC / DC operated	6/28
AF09Z ... AF38Z	AC / DC operated - low consumption	6/29
AF40 ... AF96	AC / DC operated	6/30
Main accessories		6/32

### 55 to 200 kW / 75 to 350 hp

AF116 ... AF146	AC / DC operated	6/34
AF190 ... AF370	AC / DC operated	6/36
Main accessories		6/38

### 200 to 560 kW / 350 to 900 hp

AF400 ... AF750	AC / DC operated	6/40
AF1250 ... AF2650	AC / DC operated	6/41
Main accessories		6/42

## AF and EK 4-pole contactors - Overview 6/44

### 25 to 125 A AC-1

AF09 ... AF38	AC / DC operated	6/46
AF09Z ... AF38Z	AC / DC operated - low consumption	6/47
AF40 ... AF80	AC / DC operated	6/48
Main accessories		6/50

### 160 to 525 A AC-1

AF116 ... AF140	AC / DC operated	6/52
AF190 ... AF370	AC / DC operated	6/53
Main accessories		6/54

### 800 to 1000 A AC-1

EK550, EK1000	AC operated	6/56
EK550, EK1000	DC operated	6/57
Main accessories		6/58

## NF contactor relays

NF	AC / DC operated	6/60
NFZ	AC / DC operated - low consumption	6/61
Main accessories		6/62

## Voltage code table 6/64

For direct product details information, use product type or order code, ex:  
[www.abb.com/productdetails/AF09-30-10-13](http://www.abb.com/productdetails/AF09-30-10-13) or [www.abb.com/productdetails/1SBL137001R1310](http://www.abb.com/productdetails/1SBL137001R1310)

# DOL and reversing starters protected by manual motor starters With AF contactors - open type version in kit form



1SFC101102X0001

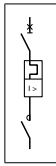

## Application

Full voltage direct-on-line (DOL) starting and reversing starting for controlling three-phase asynchronous motors is a simple and economic solution characterised by a high starting torque (1.9 to 2.1 times full-speed torque) and a starting current 5.5 to 7 times nominal current.

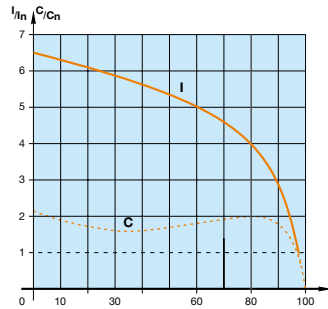

I = current  
C = torque  
In = nominal current  
Cn = nominal torque

6

## DOL starter MS132-10 + BEA16-4 + AF09-30-10

## Coordination types

The contactor and the manual motor starter control and protect motors against overload and short-circuits according to coordination types 1 and 2 (IEC 60947-4-1 / EN 60947-4-1) defining the anticipated level of service continuity as follow:

**Type 1:** In short-circuit conditions, the contactor or starter does not endanger persons or installations and will not be able to then operate without being repaired or having parts replaced.

**Type 2:** In short-circuit conditions, the contactor or starter does not endanger persons or installations and will be able to operate afterwards. The risk of contacts light welding is acceptable.

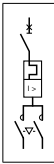

1SFC101105V0001

## Reversing starter MS132-10 + BEA16-4 + BER16-4 + VEM4 + AF09-30-10

## Main Technical Data

<b>Standards</b>	IEC 60947-4-1 / EN 60947-4-1	
<b>Rated operational voltage Ue max.</b>	690 V - 50/60 Hz	
<b>Rated insulation voltage Ui</b>		
acc. to IEC 60947-4-1	690 V	
acc. to UL / CSA	600 V	
<b>Switching frequency</b>		
	≤ 15 starts/hour - 80 % max. load factor - with max. 1.5 s starting time	
	≤ 30 starts/hour - 50 % max. load factor - with max. 1.5 s starting time	
<b>Ambient air temperature</b>		
Close to the device	<b>use with MS116</b>	≤ 55 °C
	<b>use with MS132, MS450, MS495</b>	≤ 60 °C
<b>Degree of protection</b>	IP20	

## Mounting positions

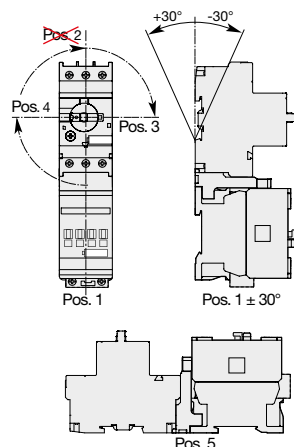

DOL starters

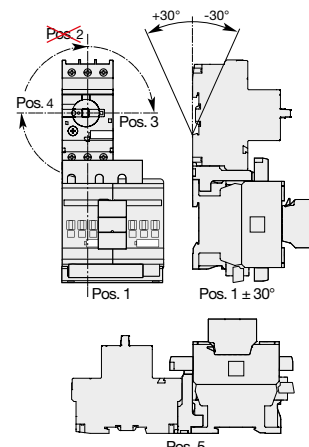

Reversing starters



# DOL and reversing starters protected by manual motor starters With AF contactors - open type version in kit form

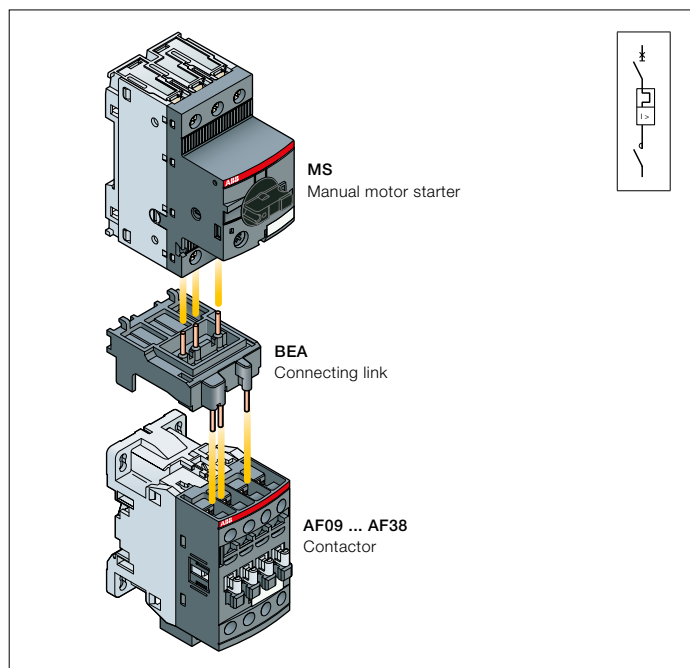

## Direct-on-line starters

### Description

You can easily assemble a direct-on-line starter by using the BEA...-4 connecting link 3-pole insulated. It is used to electrically and mechanically connect MS116 or MS132 manual motor starter and AF09 ... AF38 contactor, AC or DC operated.

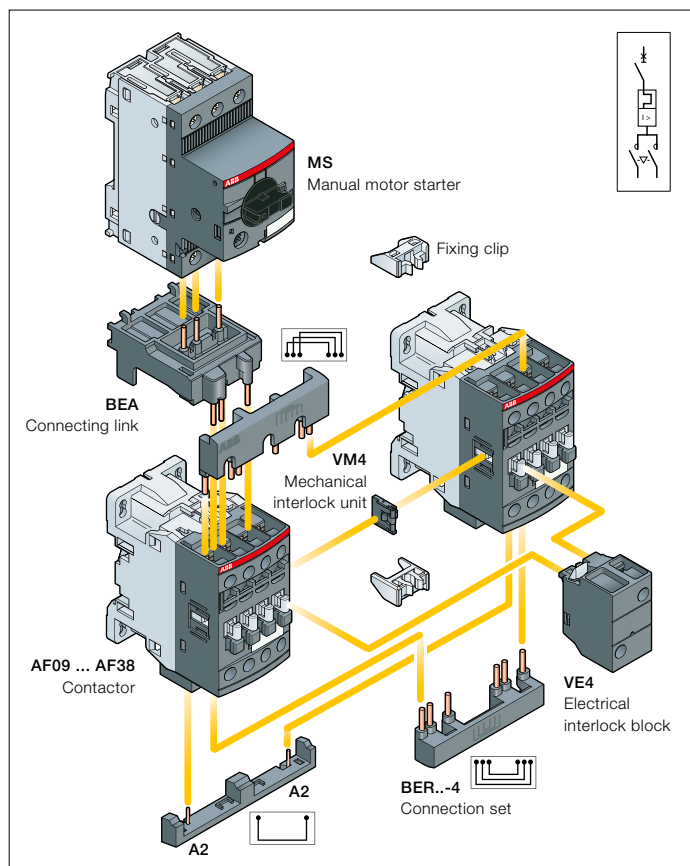

## Reversing starters

### Description

You can easily assemble reversing starter thanks to our complete range of accessories:

- BEA...-4 connecting link 3-pole insulated: it is used to electrically and mechanically connect MS116 or MS132 manual motor starter and AF09 ... AF38 contactor, AC or DC operated
- For AF09 ... AF38, use VEM4 mechanical and electrical interlock set for reversing starter in 90 mm width. It includes:
  - VM4 mechanical interlock unit including 2 fixing clips
  - VE4 electrical interlock block with A2-A2 connection.
- For AF40 ... AF96, use VM96-4 mechanical interlock unit and additional auxiliary contact blocks for electrical interlocking
- BER...-4 connection set: it assures a safe and simple reversing connection between both contactor main terminals.

Select now easily and quickly your starter in the following pages for coordination type 1 or 2 at 400 V, 50 / 60 Hz, I<sub>q</sub> = 16 kA up to 18.5 kW and I<sub>q</sub> = 50 kA up to 45 kW.



For the full coordination tables:

[www.abb.com/lowvoltage](http://www.abb.com/lowvoltage) then go to the right menu: "Support", select: "Online Product Selection Tools" then select "Coordination Tables for motor protection"

# DOL starters protected by MS manual motor starters

## Coordination type 1

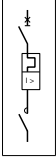
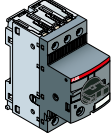
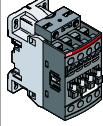
### Coordination type 1, AC-3, 16 kA or 50 kA, 400 V, 50/60 Hz

		Manual motor starters					Contactors					Accessories	
												 	
IEC AC-3, 400 V Rated operational power kW	Type (1) current A	Order code	Current setting range A	Magnetic tripping current A	Rated control circuit voltage Uc min. ... Uc max. (2)	Type (3)		Order code	Allowed setting current A	Type	Order code		
						V 50/60 Hz	V DC						
0.06	0.2	MS132-0.25 1SAM350000R1002	0.16...0.25	2.44	24...60	20...60	AF09Z-30-10-21	1SBL136001R2110	0.25	BEA16-4	1SBN081306T1000		
0.09	0.3	MS132-0.4 1SAM350000R1003	0.25...0.40	3.9	24...60	20...60	AF09Z-30-10-21	1SBL136001R2110	0.4				
0.12	0.44	MS132-0.63 1SAM350000R1004	0.40...0.63	6.14	24...60	20...60	AF09Z-30-10-21	1SBL136001R2110	0.63				
0.18	0.6	MS132-0.63 1SAM350000R1004	0.40...0.63	6.14	24...60	20...60	AF09Z-30-10-21	1SBL136001R2110	0.63				
0.25	0.85	MS132-1.0 1SAM350000R1005	0.63...1.00	11.5	24...60	20...60	AF09Z-30-10-21	1SBL136001R2110	1				
0.37	1.1	MS132-1.6 1SAM350000R1006	1.00...1.60	18.4	24...60	20...60	AF09Z-30-10-21	1SBL136001R2110	1.6				
0.55	1.5	MS132-1.6 1SAM350000R1006	1.00...1.60	18.4	24...60	20...60	AF09Z-30-10-21	1SBL136001R2110	1.6				
0.75	1.9	MS132-2.5 1SAM350000R1007	1.60...2.50	28.75	24...60	20...60	AF09Z-30-10-21	1SBL136001R2110	2.5				
1.1	2.7	MS132-4.0 1SAM350000R1008	2.50...4.00	50	24...60	20...60	AF09Z-30-10-21	1SBL136001R2110	4				
1.5	3.6	MS132-4.0 1SAM350000R1008	2.50...4.00	50	24...60	20...60	AF09Z-30-10-21	1SBL136001R2110	4				
2.2	4.9	MS132-6.3 1SAM350000R1009	4.00...6.30	78.75	24...60	20...60	AF09Z-30-10-21	1SBL136001R2110	6.3				
3	6.5	MS132-10 1SAM350000R1010	6.30...10.0	150	24...60	20...60	AF09Z-30-10-21	1SBL136001R2110	9				
4	8.5	MS132-10 1SAM350000R1010	6.30...10.0	150	24...60	20...60	AF09Z-30-10-21	1SBL136001R2110	9				
5.5	11.5	MS132-12 1SAM350000R1012	8.00...12.0	180	24...60	20...60	AF12Z-30-10-21	1SBL156001R2110	12				
7.5	15.5	MS132-16 1SAM350000R1011	10.0...16.0	240	24...60	20...60	AF16Z-30-10-21	1SBL176001R2110	16				
11	22	MS132-25 1SAM350000R1014	20.0...25.0	375	24...60	20...60	AF26Z-30-00-21	1SBL236001R2100	25	+ BEA38-4 CA4-10	1SBN082306T2000 1SBN010110R1010		
15	29	MS132-32 1SAM350000R1015	25.0...32.0	480	24...60	20...60	AF30Z-30-00-21	1SBL276001R2100	32				
18.5	35	MS450-40 1SAM450000R1005	28.0...40.0	520	24...60	20...60	AF38Z-30-00-21	1SBL296001R2100	38				
22	41	MS450-50 1SAM450000R1007	36.0...50.0	650	24...60	20...60	AF52-30-00-11	1SBL367001R1100	50	CA4-10	1SBN010110R1010		
30	55	MS495-63 1SAM550000R1007	45.0...63.0	819	24...60	20...60	AF65-30-00-11	1SBL387001R1100	63				
37	66	MS495-75 1SAM550000R1008	57.0...75.0	975	24...60	20...60	AF80-30-00-11	1SBL397001R1100	75				
45	80	MS495-90 1SAM550000R1009	70.0...90.0	1170	24...60	20...60	AF80-30-00-11	1SBL397001R1100	80				
					24...60	20...60	AF80-30-00-13	1SBL397001R1300					

(1) MS116 manual motor starter can be selected according to the current setting range indicated on the coordination line, up to:

- 15 kW, 400 V - AC-3 at 16 kA
- 4 kW, 400 V - AC-3 at 50 kA.

(2) For other control voltages, see "Voltage code table".

(3) AF40 3-pole contactor can be selected for coordination type 1, 16 kA and 50 kA, 18.5 kW, 400 V - AC-3.

# DOL starters protected by MS manual motor starters

## Coordination type 2

### Coordination type 2, AC-3, 16 kA or 50 kA, 400 V, 50/60 Hz

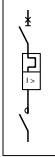
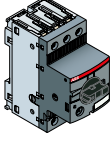
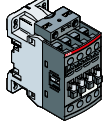
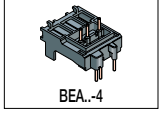
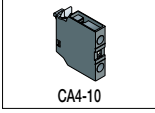
		Manual motor starters					Contactors					Accessories	
												 	
IEC AC-3, 400 V Rated operational power kW	Type (1) Rated operational current A	Order code	Current setting range A	Magnetic tripping current A	Rated control circuit voltage Uc min. ... Uc max. (2)	Type (3)	Order code	Allowed setting current A	Type (4)	Order code			
											V 50/60 Hz	V DC	
0.06	0.2	MS132-0.25 1SAM350000R1002	0.16...0.25	2.44	24...60 20...60	AF09Z-30-10-21	1SBL136001R2110	0.25	BEA16-4	1SBN081306T1000			
					100...250 100...250	AF09-30-10-13	1SBL137001R1310						
0.09	0.3	MS132-0.4 1SAM350000R1003	0.25...0.40	3.9	24...60 20...60	AF09Z-30-10-21	1SBL136001R2110	0.4					
					100...250 100...250	AF09-30-10-13	1SBL137001R1310						
0.12	0.44	MS132-0.63 1SAM350000R1004	0.40...0.63	6.14	24...60 20...60	AF09Z-30-10-21	1SBL136001R2110	0.63					
					100...250 100...250	AF09-30-10-13	1SBL137001R1310						
0.18	0.6	MS132-0.63 1SAM350000R1004	0.40...0.63	6.14	24...60 20...60	AF09Z-30-10-21	1SBL136001R2110	0.63					
					100...250 100...250	AF09-30-10-13	1SBL137001R1310						
0.25	0.85	MS132-1.0 1SAM350000R1005	0.63...1.00	11.5	24...60 20...60	AF09Z-30-10-21	1SBL136001R2110	1					
					100...250 100...250	AF09-30-10-13	1SBL137001R1310						
0.37	1.1	MS132-1.6 1SAM350000R1006	1.00...1.60	18.4	24...60 20...60	AF09Z-30-10-21	1SBL136001R2110	1.6					
					100...250 100...250	AF09-30-10-13	1SBL137001R1310						
0.55	1.5	MS132-1.6 1SAM350000R1006	1.00...1.60	18.4	24...60 20...60	AF09Z-30-10-21	1SBL136001R2110	1.6					
					100...250 100...250	AF09-30-10-13	1SBL137001R1310						
0.75	1.9	MS132-2.5 1SAM350000R1007	1.60...2.50	28.75	24...60 20...60	AF09Z-30-10-21	1SBL136001R2110	2.5					
					100...250 100...250	AF09-30-10-13	1SBL137001R1310						
1.1	2.7	MS132-4.0 1SAM350000R1008	2.50...4.00	50	24...60 20...60	AF26Z-30-00-21	1SBL236001R2100	4	+	BEA26-4 CA4-10	1SBN082306T1000 1SBN010110R1010		
					100...250 100...250	AF26-30-00-13	1SBL237001R1300						
1.5	3.6	MS132-4.0 1SAM350000R1008	2.50...4.00	50	24...60 20...60	AF26Z-30-00-21	1SBL236001R2100	4					
					100...250 100...250	AF26-30-00-13	1SBL237001R1300						
2.2	4.9	MS132-6.3 1SAM350000R1009	4.00...6.30	78.75	24...60 20...60	AF26Z-30-00-21	1SBL236001R2100	6.3					
					100...250 100...250	AF26-30-00-13	1SBL237001R1300						
3	6.5	MS132-10 1SAM350000R1010	6.30...10.0	150	24...60 20...60	AF26Z-30-00-21	1SBL236001R2100	10					
					100...250 100...250	AF26-30-00-13	1SBL237001R1300						
4	8.5	MS132-10 1SAM350000R1010	6.30...10.0	150	24...60 20...60	AF26Z-30-00-21	1SBL236001R2100	10					
					100...250 100...250	AF26-30-00-13	1SBL237001R1300						
5.5	11.5	MS132-12 1SAM350000R1012	8.00...12.0	180	24...60 20...60	AF26Z-30-00-21	1SBL236001R2100	12	+	BEA38-4 CA4-10	1SBN082306T2000 1SBN010110R1010		
					100...250 100...250	AF26-30-00-13	1SBL237001R1300						
7.5	15.5	MS132-16 1SAM350000R1011	10.0...16.0	240	24...60 20...60	AF30Z-30-00-21	1SBL276001R2100	16					
					100...250 100...250	AF30-30-00-13	1SBL277001R1300						
11	22	MS132-25 1SAM350000R1014	20.0...25.0	375	24...60 20...60	AF30Z-30-00-21	1SBL276001R2100	25					
					100...250 100...250	AF30-30-00-13	1SBL277001R1300						
15	29	MS132-32 1SAM350000R1015	25.0...32.0	480	24...60 20...60	AF30Z-30-00-21	1SBL276001R2100	32					
					100...250 100...250	AF30-30-00-13	1SBL277001R1300						
18.5	35	MS450-40 1SAM450000R1005	28.0...40.0	520	24...60 20...60	AF38Z-30-00-21	1SBL296001R2100	40	CA4-10	1SBN010110R1010			
					100...250 100...250	AF38-30-00-13	1SBL297001R1300						
22	41	MS450-50 1SAM450000R1007	36.0...50.0	650	24...60 20...60	AF52-30-00-11	1SBL367001R1100	50					
					100...250 100...250	AF52-30-00-13	1SBL367001R1300						
30	55	MS495-63 1SAM550000R1007	45.0...63.0	819	24...60 20...60	AF65-30-00-11	1SBL387001R1100	63					
					100...250 100...250	AF65-30-00-13	1SBL387001R1300						
37	66	MS495-75 1SAM550000R1008	57.0...75.0	975	24...60 20...60	AF80-30-00-11	1SBL397001R1100	75					
					100...250 100...250	AF80-30-00-13	1SBL397001R1300						
45	80	MS495-90 1SAM550000R1009	70.0...90.0	1170	24...60 20...60	AF96-30-00-11	1SBL407001R1100	90					
					100...250 100...250	AF96-30-00-13	1SBL407001R1300						

- (1) MS116 manual motor starter can be selected according to the current setting range indicated on the coordination line, up to  
 - 15 kW 400V - AC-3 at 16 kA  
 - 4 kW, 400 V - AC-3 at 50 kA.
- (2) For other control voltages, see "Voltage code table".
- (3) AF26 3-pole contactor can be selected for coordination type 2, 16 kA, 7.5 kW, 400 V - AC-3.  
 AF40 3-pole contactor can be selected for coordination type 2, 16 kA and 50 kA, 18.5 kW, 400 V - AC-3.
- (4) BEA26-4 should be selected with MS116-12 ... MS116-16 and AF26 ... AF38.  
 BEA38-4 can only be selected with MS116-20 ... MS116-32.

# Reversing starters protected by MS manual motor starters

## Coordination type 1

### Coordination type 1, AC-3, 16 kA or 50 kA, 400 V, 50/60 Hz

		Manual motor starters					Contactors					Accessories	
IEC AC-3, 400 V Rated operational power : kW	Type (1)	Order code	Current setting range	Magnetic tripping current	Rated control circuit voltage Uc min. ... Uc max. (2)	Type (3)		Order code	Allowed setting current	Type	Order code		
						V 50/60 Hz	V DC						
0.06	0.2	MS132-0.25	1SAM35000R1002	0.16...0.25	2.44	24...60	20...60	AF09Z-30-10-21	1SBL136001R2110	0.25			
0.09	0.3	MS132-0.4	1SAM35000R1003	0.25...0.40	3.9	24...60	20...60	AF09Z-30-10-21	1SBL137001R1310	0.4	+ + VEM4		
0.12	0.44	MS132-0.63	1SAM35000R1004	0.40...0.63	6.14	24...60	20...60	AF09Z-30-10-21	1SBL136001R2110	0.63			
0.18	0.6	MS132-0.63	1SAM35000R1004	0.40...0.63	6.14	24...60	20...60	AF09Z-30-10-21	1SBL137001R1310	0.63			
0.25	0.85	MS132-1.0	1SAM35000R1005	0.63...1.00	11.5	24...60	20...60	AF09Z-30-10-21	1SBL136001R2110	1			
0.37	1.1	MS132-1.6	1SAM35000R1006	1.00...1.60	18.4	24...60	20...60	AF09Z-30-10-21	1SBL137001R1310	1.6			
0.55	1.5	MS132-1.6	1SAM35000R1006	1.00...1.60	18.4	24...60	20...60	AF09Z-30-10-21	1SBL136001R2110	1.6			
0.75	1.9	MS132-2.5	1SAM35000R1007	1.60...2.50	28.75	24...60	20...60	AF09Z-30-10-21	1SBL137001R1310	2.5			
1.1	2.7	MS132-4.0	1SAM35000R1008	2.50...4.00	50	24...60	20...60	AF09Z-30-10-21	1SBL136001R2110	4			
1.5	3.6	MS132-4.0	1SAM35000R1008	2.50...4.00	50	24...60	20...60	AF09Z-30-10-21	1SBL137001R1310	4			
2.2	4.9	MS132-6.3	1SAM35000R1009	4.00...6.30	78.75	24...60	20...60	AF09Z-30-10-21	1SBL136001R2110	6.3			
3	6.5	MS132-10	1SAM35000R1010	6.30...10.0	150	24...60	20...60	AF09Z-30-10-21	1SBL137001R1310	9			
4	8.5	MS132-10	1SAM35000R1010	6.30...10.0	150	24...60	20...60	AF09Z-30-10-21	1SBL136001R2110	9			
5.5	11.5	MS132-12	1SAM35000R1012	8.00...12.0	180	24...60	20...60	AF12Z-30-10-21	1SBL156001R2110	12			
7.5	15.5	MS132-16	1SAM35000R1011	10.0...16.0	240	24...60	20...60	AF16Z-30-10-21	1SBL176001R2110	16			
11	22	MS132-25	1SAM35000R1014	20.0...25.0	375	24...60	20...60	AF26Z-30-00-21	1SBL236001R2100	25	+ + +2x		
15	29	MS132-32	1SAM35000R1015	25.0...32.0	480	24...60	20...60	AF26Z-30-00-13	1SBL237001R1300	32	+ +2x		
18.5	35	MS450-40	1SAM45000R1005	28.0...40.0	520	24...60	20...60	AF30Z-30-00-21	1SBL276001R2100	38	+ +2x		
22	41	MS450-50	1SAM45000R1007	36.0...50.0	650	24...60	20...60	AF30Z-30-00-13	1SBL277001R1300	50	+ +2x		
30	55	MS495-63	1SAM55000R1007	45.0...63.0	819	24...60	20...60	AF38Z-30-00-21	1SBL296001R2100	63	+ +2x		
37	66	MS495-75	1SAM55000R1008	57.0...75.0	975	24...60	20...60	AF38Z-30-00-13	1SBL297001R1300	75	+ +2x		
45	80	MS495-90	1SAM55000R1009	70.0...90.0	1170	24...60	20...60	AF52-30-00-11	1SBL367001R1100	80	+ +2x		
						100...250	100...250	AF52-30-00-13	1SBL367001R1300		+ +2x		
						100...250	100...250	AF80-30-00-11	1SBL397001R1100		+ +2x		
						100...250	100...250	AF80-30-00-13	1SBL397001R1300		+ +2x		

(1) MS116 manual motor starter can be selected according to the current setting range indicated on the coordination line, up to:  
 - 15 kW, 400 V - AC-3 at 16 kA  
 - 4 kW, 400 V - AC-3 at 50 kA.

(2) For other control voltages, see "Voltage code table".

(3) AF40 3-pole contactor can be selected for coordination type 1, 16 kA and 50 kA, 18.5 kW, 400 V - AC-3.

# Reversing starters protected by MS manual motor starters

## Coordination type 2

### Coordination type 2, AC-3, 16 kA or 50 kA, 400 V, 50/60 Hz

		Manual motor starters					Contactors					Accessories		
IEC AC-3, 400 V Rated operational power kW	Type (1)	Order code	Current setting range A	Magnetic tripping current A	Rated control circuit voltage Uc min. ... Uc max. (2)	Type (3)	Order code	Allowed setting current A	Type (4)	Order code				
A					V 50/60 Hz   V DC									
0.06	0.2	MS132-0.25	1SAM350000R1002	0.16...0.25	2.44	24...60   20...60	AF09Z-30-10-21   1SBL136001R2110	0.25						
0.09	0.3	MS132-0.4	1SAM350000R1003	0.25...0.40	3.9	24...60   20...60	AF09Z-30-10-21   1SBL136001R2110	0.4						
0.12	0.44	MS132-0.63	1SAM350000R1004	0.40...0.63	6.14	24...60   20...60	AF09Z-30-10-21   1SBL136001R2110	0.63						
0.18	0.6	MS132-0.63	1SAM350000R1004	0.40...0.63	6.14	24...60   20...60	AF09Z-30-10-21   1SBL136001R2110	0.63						
0.25	0.85	MS132-1.0	1SAM350000R1005	0.63...1.00	11.5	24...60   20...60	AF09Z-30-10-21   1SBL136001R2110	1						
0.37	1.1	MS132-1.6	1SAM350000R1006	1.00...1.60	18.4	24...60   20...60	AF09Z-30-10-21   1SBL136001R2110	1.6						
0.55	1.5	MS132-1.6	1SAM350000R1006	1.00...1.60	18.4	24...60   20...60	AF09Z-30-10-21   1SBL136001R2110	1.6						
0.75	1.9	MS132-2.5	1SAM350000R1007	1.60...2.50	28.75	24...60   20...60	AF09Z-30-10-21   1SBL136001R2110	2.5						
1.1	2.7	MS132-4.0	1SAM350000R1008	2.50...4.00	50	24...60   20...60	AF26Z-30-00-21   1SBL236001R2100	4						
1.5	3.6	MS132-4.0	1SAM350000R1008	2.50...4.00	50	24...60   20...60	AF26Z-30-00-21   1SBL236001R2100	4						
2.2	4.9	MS132-6.3	1SAM350000R1009	4.00...6.30	78.75	24...60   20...60	AF26Z-30-00-21   1SBL236001R2100	6.3						
3	6.5	MS132-10	1SAM350000R1010	6.30...10.0	150	24...60   20...60	AF26Z-30-00-21   1SBL236001R2100	10						
4	8.5	MS132-10	1SAM350000R1010	6.30...10.0	150	24...60   20...60	AF26Z-30-00-21   1SBL236001R2100	10						
5.5	11.5	MS132-12	1SAM350000R1012	8.00...12.0	180	24...60   20...60	AF26Z-30-00-21   1SBL236001R2100	12						
7.5	15.5	MS132-16	1SAM350000R1011	10.0...16.0	240	24...60   20...60	AF30Z-30-00-21   1SBL276001R2100	16						
11	22	MS132-25	1SAM350000R1014	20.0...25.0	375	24...60   20...60	AF30Z-30-00-21   1SBL276001R2100	25						
15	29	MS132-32	1SAM350000R1015	25.0...32.0	480	24...60   20...60	AF30Z-30-00-21   1SBL276001R2100	32						
18.5	35	MS450-40	1SAM450000R1005	28.0...40.0	520	24...60   20...60	AF38Z-30-00-21   1SBL296001R2100	40						
22	41	MS450-50	1SAM450000R1007	36.0...50.0	650	24...60   20...60	AF52-30-00-11   1SBL367001R1100	50						
30	55	MS495-63	1SAM550000R1007	45.0...63.0	819	24...60   20...60	AF65-30-00-11   1SBL387001R1100	63						
37	66	MS495-75	1SAM550000R1008	57.0...75.0	975	24...60   20...60	AF80-30-00-11   1SBL397001R1100	75						
45	80	MS495-90	1SAM550000R1009	70.0...90.0	1170	24...60   20...60	AF96-30-00-11   1SBL407001R1100	90						

(1) MS116 manual motor starter can be selected according to the current setting range indicated on the coordination line, up to

- 15 kW 400V - AC-3 at 16 kA
- 4 kW, 400 V - AC-3 at 50 kA.

(2) For other control voltages, see "Voltage code table".

(3) AF26 3-pole contactor can be selected for coordination type 2, 16 kA, 7.5 kW, 400 V - AC-3.

AF40 3-pole contactor can be selected for coordination type 2, 16 kA and 50 kA, 18.5 kW, 400 V - AC-3.

(4) BEA26-4 should be selected with MS116-12 ... MS116-16 and AF26 ... AF38.

BEA38-4 can only be selected with MS116-20 ... MS116-32.

# DOL starters protected by moulded-case circuit-breakers and overload relays

## With AF contactors - Open type version in kit form



1SFC101181V0001

### Application

Full voltage direct-on-line (DOL) starting for controlling three-phase asynchronous motors is a simple and economic solution characterised by a high starting torque (1.9 to 2.1 times full-speed torque) and a starting current 5.5 to 7 times nominal current.

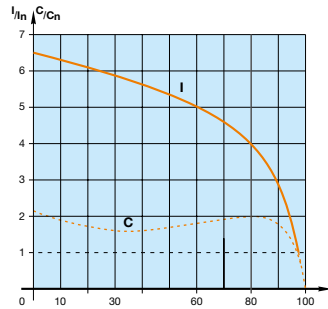

I = current  
C = torque  
In = nominal current  
Cn = nominal torque

6

XT2S 160 + BEA140/XT2 + AF140-30-11

### Coordination types

The contactor and the moulded-case circuit-breaker control and protect motors against overload and short-circuits according to coordination types 1 and 2 (IEC 60947-4-1/EN 60947-4-1) defining the anticipated level of service continuity as follows:

**Type 1:** In short-circuit conditions, the contactor or starter does not endanger persons or installations and will not be able to then operate without being repaired or having parts replaced.

**Type 2:** In short-circuit conditions, the contactor or starter does not endanger persons or installations and will be able to operate afterwards. The risk of contacts light welding is acceptable.

### Main Technical Data

Standards	IEC 60947-4-1 / EN 60947-4-1
Rated operational voltage $U_e$ max.	400 V - 50/60 Hz
Rated insulation voltage $U_i$	
acc. to IEC 60947-4-1	690 V
acc. to UL / CSA	600 V
Switching frequency	≤ 15 starts/hour - 80 % max. load factor - with max. 1.5 s starting time ≤ 30 starts/hour - 50 % max. load factor - with max. 1.5 s starting time
Ambient air temperature	
Close to the device	< 55 °C
Degree of protection	IP20



1SFC101180V0001

XT2S 160 + BEA140/XT2 + AF140-30-11 + EF146

### Mounting positions

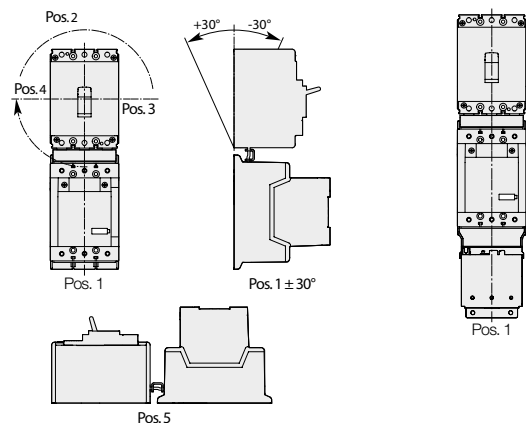

Direct-on-line  
MCCB + AF

Direct-on-line  
MCCB + AF + OL

# DOL starters protected by moulded-case circuit-breakers and overload relays

## With AF contactors - Open type version in kit form

### Description

You can easily assemble a direct-on-line starter by using the BEA connection bars. It is used to electrically connect MCCB moulded-case circuit-breaker and AF116 ... AF370 contactor, AC or DC operated.

**Select now easily and quickly your starter in the following pages** for coordination type 1 or 2 at 400 V, 50 / 60 Hz, I<sub>q</sub> = 50 kA up to 200 kW.

For the full coordination tables: [www.abb.com/lowvoltage](http://www.abb.com/lowvoltage) then go to the right menu: "Support", select: "Online Product Selection Tools" then select "Coordination Tables for motor protection"

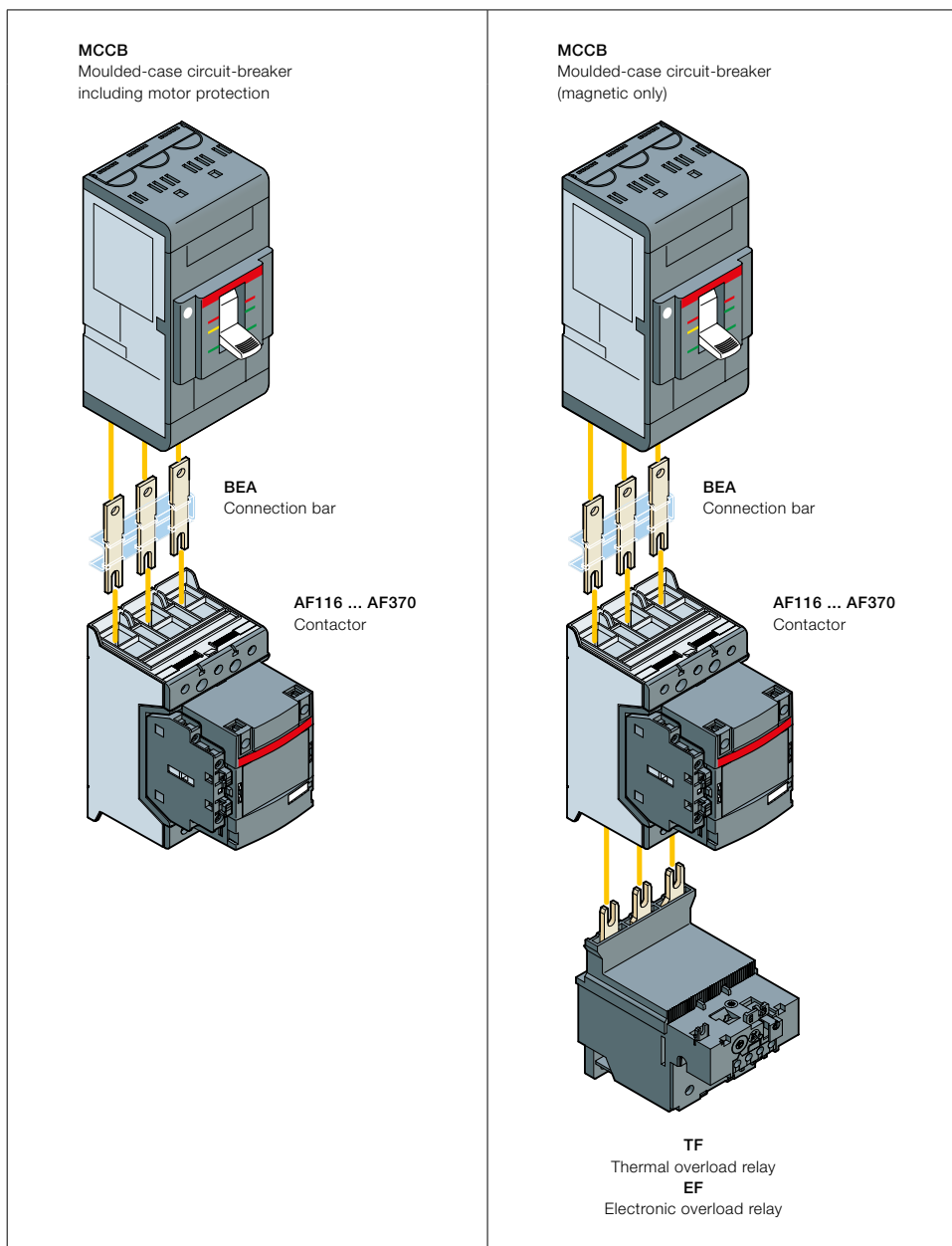

# DOL starters protected by MCCB including motor protection Coordination type 1 or 2

## Coordination type 1 or 2, AC-3, 50 kA, 400 V, 50/60 Hz

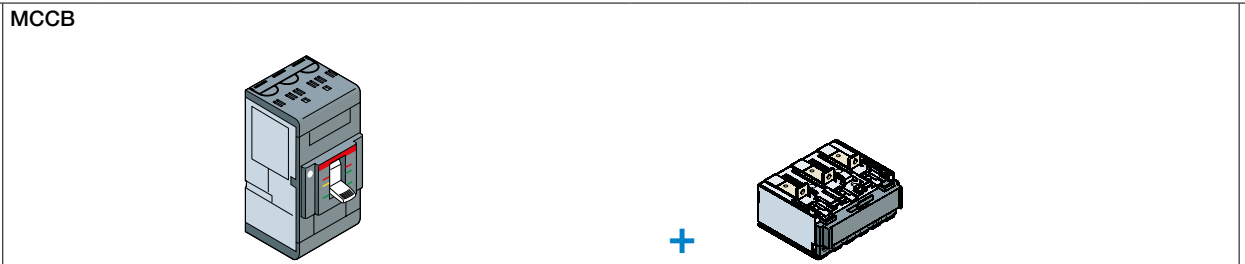

IEC AC-3, 400 V Rated power kW		Rated current A	Magnetic tripping current setting A	Max. allowed thermal setting	Base Type	Order code		Trip unit Type	Order code
55	97	1440	116	116	XT2S 160	1SDA068164R1		+ Ekip M-LIU In160	1SDA067355R1
75	132	1920	140	140	XT2S 160	1SDA068164R1		+ Ekip M-LIU In160	1SDA067355R1
90	160	2400	190	190	T4S 250 PR222MP In200	1SDA054527R1		Included	-
110	195	2880	205	205	T5S 400 PR222MP In320	1SDA054553R1		Included	-
132	230	3600	265	265	T5S 400 PR222MP In400	1SDA054554R1		Included	-
160	280	4400	305	305	T5S 400 PR222MP In400	1SDA054554R1		Included	-



**Contactors**

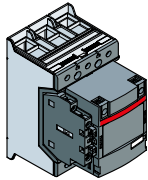

**Connection bars**



Control voltage Uc min. ... Uc max.		Type	Order code	Type	Order code
V 50/60 Hz	V DC				
24...60	20...60	AF116-30-11-11	1SFL427001R1111	BEA140/XT2	1SFN084206R1000
100...250	100...250	AF116-30-11-13	1SFL427001R1311		
24...60	20...60	AF140-30-11-11	1SFL447001R1111		
100...250	100...250	AF140-30-11-13	1SFL447001R1311		
24...60	20...60	AF190-30-11-11	1SFL487002R1111	BEA205/T4	1SFN084806R1001
100...250	100...250	AF190-30-11-13	1SFL487002R1311		
24...60	20...60	AF205-30-11-11	1SFL527002R1111	BEA370/T5	1SFN085406R1000
100...250	100...250	AF205-30-11-13	1SFL527002R1311		
24...60	20...60	AF265-30-11-11	1SFL547002R1111		
100...250	100...250	AF265-30-11-13	1SFL547002R1311		
24...60	20...60	AF305-30-11-11	1SFL587002R1111		
100...250	100...250	AF305-30-11-13	1SFL587002R1311		

# DOL starters protected by MCCB (magnetic only) and overload relays

## Coordination type 1 or 2

### Coordination type 1 or 2, AC-3, 50 kA, 400 V, 50/60 Hz

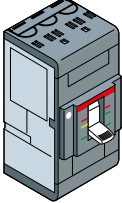
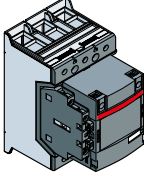
<b>MCCB</b> 	<b>Contactors</b> 
--	--

#### Thermal overload relays

IEC AC-3, 400 V Rated power kW	Rated current A	Magnetic tripping current A	Type	Order code	Control voltage Uc min. ... Uc max.		Type	Order code
					V 50/60 Hz	V DC		
55	97	1600	XT2S 160 MA 160	1SDA076530R1	24...60	20...60	AF116-30-11-11	1SFL427001R1111
					100...250	100...250	AF116-30-11-13	1SFL427001R1311
75	132	1920	XT2S 160 MA 160	1SDA076530R1	24...60	20...60	AF140-30-11-11	1SFL447001R1111
					100...250	100...250	AF140-30-11-13	1SFL447001R1311
90	160	2250	XT4S 250 Ekip I In250	1SDA068480R1	24...60	20...60	AF190-30-11-11	1SFL487002R1111
					100...250	100...250	AF190-30-11-13	1SFL487002R1311
110	195	2720	T4S 320 PR221-I In320	1SDA054126R1	24...60	20...60	AF205-30-11-11	1SFL527002R1111
					100...250	100...250	AF205-30-11-13	1SFL527002R1311

#### Electronic overload relays

55	97	1600	XT2S 160 MA 160	1SDA076530R1	24...60	20...60	AF116-30-11-11	1SFL427001R1111
					100...250	100...250	AF116-30-11-13	1SFL427001R1311
75	132	1920	XT2S 160 MA 160	1SDA076530R1	24...60	20...60	AF140-30-11-11	1SFL447001R1111
					100...250	100...250	AF140-30-11-13	1SFL447001R1311
90	160	2250	XT4S 250 Ekip I In250	1SDA068480R1	24...60	20...60	AF190-30-11-11	1SFL487002R1111
					100...250	100...250	AF190-30-11-13	1SFL487002R1311
110	195	2720	T4S 320 PR221-I In320	1SDA054126R1	24...60	20...60	AF205-30-11-11	1SFL527002R1111
					100...250	100...250	AF205-30-11-13	1SFL527002R1311
132	230	3200	T5S 400 PR221-I In400	1SDA054335R1	24...60	20...60	AF265-30-11-11	1SFL547002R1111
					100...250	100...250	AF265-30-11-13	1SFL547002R1311
160	280	4000	T5S 400 PR221-I In400	1SDA054335R1	24...60	20...60	AF305-30-11-11	1SFL587002R1111
					100...250	100...250	AF305-30-11-13	1SFL587002R1311
200	350	5040	T5S 630 PR221-I In630	1SDA054405R1	24...60	20...60	AF370-30-11-11	1SFL607002R1111
					100...250	100...250	AF370-30-11-13	1SFL607002R1311

### Overload relays

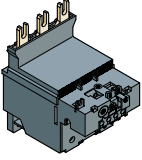

### Connection bars

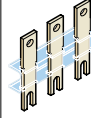

Setting ranges	Max. allowed setting current	Type	Order code	Type	Order code
A	A				
80...110	110	TF140DU-110	1SAZ431201R1002	BEA140/XT2	1SFN084206R1000
110...142	140	TF140DU-142	1SAZ431201R1004		
130...175	175	TA200DU-175	1SAZ421201R1005	BEA205/XT4	1SFN084806R1000
155...200	200	TA200DU-200	1SAZ421201R1006	BEA205/T4	1SFN084806R1001
54...150	116	EF146-150	1SAX351001R1101	BEA140/XT2	1SFN084206R1000
54...150	140	EF146-150	1SAX351001R1101		
63...210	190	EF205-210	1SAX531001R1101	BEA205/XT4	1SFN084806R1000
63...210	205	EF205-210	1SAX531001R1101	BEA205/T4	1SFN084806R1001
115...380	265	EF370-380	1SAX611001R1101	BEA370/T5	1SFN085406R1000
115...380	305	EF370-380	1SAX611001R1101		
115...380	350	EF370-380	1SAX611001R1101		

# DOL and reversing starters protected by overload relays With AF contactors - Open type version in kit form

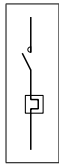

## Application

Full voltage direct-on-line and reversing starting for controlling three-phase asynchronous motors is a simple and economic solution characterised by a high starting torque (1.9 to 2.1 times full-speed torque) and a starting current 5.5 to 7 times nominal current.

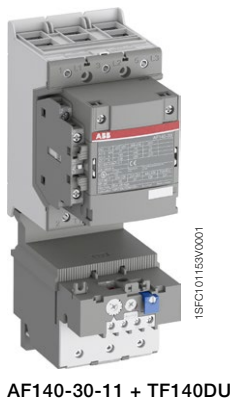
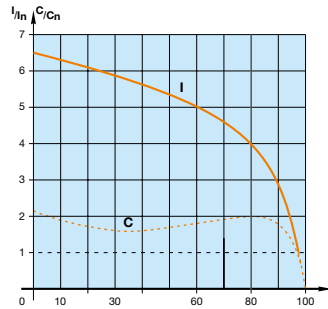

## Coordination Types

The contactor, the short-circuit protection device and the thermal overload relay control and protect motors against overload and short-circuits according to coordination types 1 and 2 (IEC 60947-4-1 / EN 60947-4-1) defining the anticipated level of service continuity as follow:

**Type 1:** In short-circuit conditions, the contactor or starter does not endanger persons or installations and will not be able to then operate without being repaired or having parts replaced.

**Type 2:** In short-circuit conditions, the contactor or starter does not endanger persons or installations and will be able to operate afterwards. The risk of contacts light welding is acceptable.

## Main Technical Data

<b>Standards</b>	IEC 60947-4-1 / EN 60947-4-1
<b>Rated operational voltage <math>U_e</math> max.</b>	690 V - 50/60 Hz
<b>Rated insulation voltage <math>U_i</math></b>	
acc. to IEC 60947-4-1	690 V
acc. to UL / CSA	600 V
<b>Ambient air temperature</b>	
Close to the device	$\leq 60$ °C (TF42: 38 A above $\leq 50$ °C)
<b>Degree of protection</b>	IP20
<b>Switching frequency</b>	Refer to "Switching frequency diagrams" page

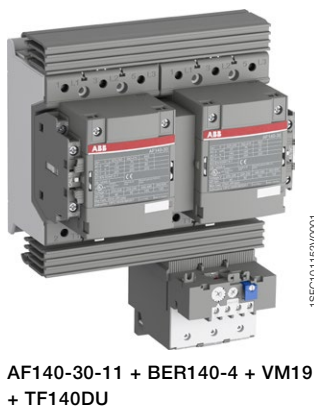
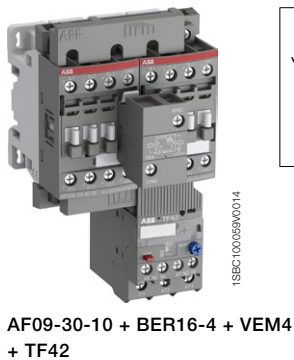

## Mounting positions



Direct-on-line

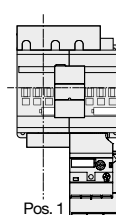

Reversing

# DOL and reversing starters protected by overload relays

## With AF contactors - Open type version in kit form

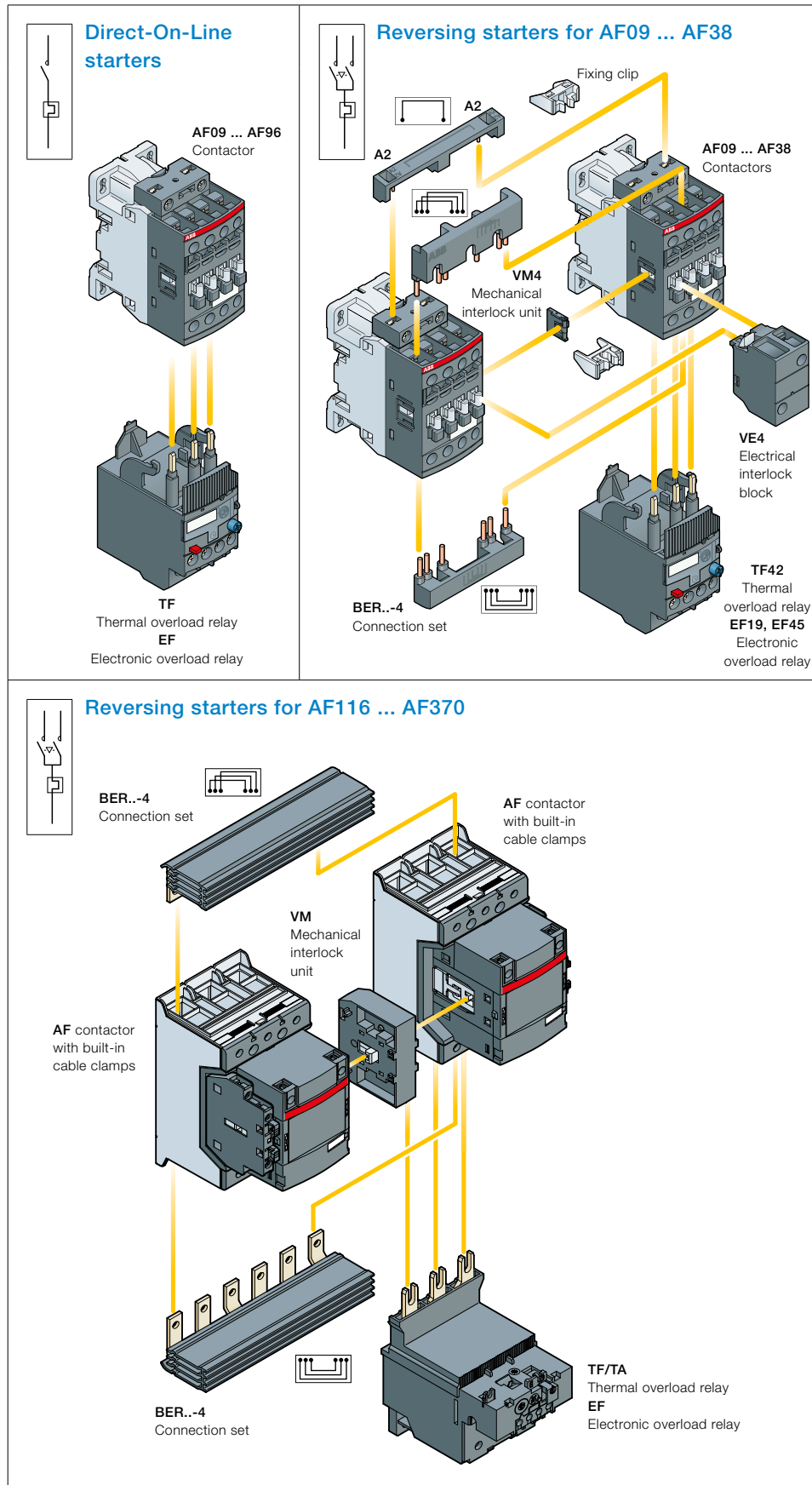

### Description

You can easily assemble a direct-on-line starter by connecting AF contactor and TF thermal overload relay or EF electronic overload relay.

You can also easily assemble reversing starter thanks to our complete range of accessories:

- For AF09 ... AF38, use VEM4 mechanical and electrical interlock set for reversing starter in 90 mm width. It includes:
  - VM4 mechanical interlock unit including 2 fixing clips
  - VE4 electrical interlock block with A2-A2 connection.
- For AF40 ... AF370, use VM mechanical interlock unit and additional auxiliary contact blocks for electrical interlocking.
- BER..-4 connection set: it assures a safe and simple reversing connection between both contactor main terminals.

**Select now easily and quickly your starter in the following pages at 400 V, up to 200 kW.**

For the full coordination tables: [www.abb.com/lowvoltage](http://www.abb.com/lowvoltage) then go to the right menu: "Support", select: "Online Product Selection Tools" then select "Coordination Tables for motor protection"

# Direct-on-line starters protected by thermal overload relays

## With AF contactors - Open type version in kit form

IEC		Control voltage Uc min. ... Uc max. (1)				Type	Order code	Setting ranges	Type	Order code
Rated power	Rated current	V 50/60 Hz		V DC			A			
4	8.5	24...60	20...60	AF09Z-30-10-21	1SBL136001R2110	7.60...10.0	TF42-10	1SAZ721201R1043		
		100...250	100...250	AF09-30-10-13	1SBL137001R1310					
5.5	11.5	24...60	20...60	AF12Z-30-10-21	1SBL156001R2110	10.0...13.0	TF42-13	1SAZ721201R1045		
		100...250	100...250	AF12-30-10-13	1SBL157001R1310					
7.5	15.5	24...60	20...60	AF16Z-30-10-21	1SBL176001R2110	13.0...16.0	TF42-16	1SAZ721201R1047		
		100...250	100...250	AF16-30-10-13	1SBL177001R1310					
11	22	24...60	20...60	AF26Z-30-00-21	1SBL236001R2100	20.0...24.0	TF42-24	1SAZ721201R1051		
		100...250	100...250	AF26-30-00-13	1SBL237001R1300					
15	29	24...60	20...60	AF30Z-30-00-21	1SBL276001R2100	29.0...35.0	TF42-35	1SAZ721201R1053		
		100...250	100...250	AF30-30-00-13	1SBL277001R1300					
18.5	35	24...60	20...60	AF38Z-30-00-21	1SBL296001R2100	35.0...38.0/40.0	TF42-38	1SAZ721201R1055		
		100...250	100...250	AF38-30-00-13	1SBL297001R1300					
18.5	35	24...60	20...60	AF40-30-00-11	1SBL347001R1100	30.0...40.0	TF65-40	1SAZ811201R1003		
		100...250	100...250	AF40-30-00-13	1SBL347001R1300					
22	41	24...60	20...60	AF52-30-00-11	1SBL367001R1100	36.00...47.0	TF65-47	1SAZ811201R1004		
		100-250	100-250	AF52-30-00-13	1SBL367001R1300					
30	55	24...60	20...60	AF65-30-00-11	1SBL387001R1100	50.0...60.0	TF65-60	1SAZ811201R1006		
		100-250	100-250	AF65-30-00-13	1SBL387001R1300					
37	66	24...60	20...60	AF80-30-00-11	1SBL397001R1100	57.0...68.0	TF96-68	1SAZ911201R1003		
		100-250	100-250	AF80-30-00-13	1SBL397001R1300					
45	80	24...60	20...60	AF96-30-00-11	1SBL407001R1100	75.0...87.0	TF96-87	1SAZ911201R1005		
		100-250	100-250	AF96-30-00-13	1SBL407001R1300					
55	97	24...60	20...60	AF116-30-11-11	1SFL427001R1111	80...110	TF140DU-110	1SAZ431201R1002		
		100-250	100-250	AF116-30-11-13	1SFL427001R1311					
75	132	24...60	20...60	AF140-30-11-11	1SFL447001R1111	100...135	TF140DU-135	1SAZ431201R1003		
		100-250	100-250	AF140-30-11-13	1SFL447001R1311					
90	160	24...60	20...60	AF190-30-11-11	1SFL487002R1111	130...175	TA200DU-175	1SAZ421201R1005		
		100-250	100-250	AF190-30-11-13	1SFL487002R1311					
110	195	24...60	20...60	AF205-30-11-11	1SFL527002R1111	150...200	TA200DU-200	1SAZ421201R1006		
		100-250	100-250	AF205-30-11-13	1SFL527002R1311					

(1) For other control voltages, see "Voltage code table".

Note : for rated power above 110 kW, refer to "Starters protected by electronic overload relays".

# Reversing starters protected by thermal overload relays

## With AF contactors - Open type version in kit form

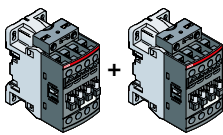
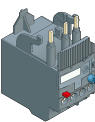
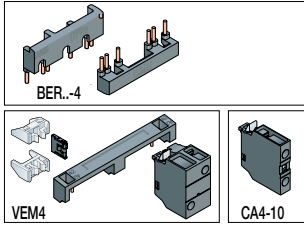
		Contactors				Thermal overload relays				Accessories	
											
IEC	Control voltage	Type	Order code		Setting ranges	Type	Order code		Type	Order code	
AC-3, 400 V	Uc min. ... Uc max.										
Rated power	Rated current										
kW	A	V 50/60 Hz	V DC		A						
4	8.5	24...60	20...60	AF09Z-30-10-21	1SBL136001R2110	7.60...10.0	TF42-10	1SAZ721201R1043	+	BER16-4 VEM4	1SBN081311R1000 1SBN030111R1000
		100...250	100...250	AF09-30-10-13	1SBL137001R1310						
5.5	11.5	24...60	20...60	AF12Z-30-10-21	1SBL156001R2110	10.0...13.0	TF42-13	1SAZ721201R1045			
		100...250	100...250	AF12-30-10-13	1SBL157001R1310						
7.5	15.5	24...60	20...60	AF16Z-30-10-21	1SBL176001R2110	13.0...16.0	TF42-16	1SAZ721201R1047			
		100...250	100...250	AF16-30-10-13	1SBL177001R1310						
11	22	24...60	20...60	AF26Z-30-00-21	1SBL236001R2100	20.0...24.0	TF42-24	1SAZ721201R1051	+	BER38-4 VEM4	1SBN082311R1000 1SBN030111R1000
		100...250	100...250	AF26-30-00-13	1SBL237001R1300						
15	29	24...60	20...60	AF30Z-30-00-21	1SBL276001R2100	29.0...35.0	TF42-35	1SAZ721201R1053	+ 2x	CA4-10	1SBN010110R1010
		100...250	100...250	AF30-30-00-13	1SBL277001R1300						
18.5	35	24...60	20...60	AF38Z-30-00-21	1SBL296001R2100	35.0...38.0/40.0	TF42-38	1SAZ721201R1055			
		100...250	100...250	AF38-30-00-13	1SBL297001R1300						
18.5	35	24...60	20...60	AF40-30-00-11	1SBL347001R1100	30.0...40.0	TF65-40	1SAZ811201R1003	+	BER65-4 VM96-4	1SBN083411R1000 1SBN033405T1000
		100...250	100...250	AF40-30-00-13	1SBL347001R1300						
22	41	24...60	20...60	AF52-30-00-11	1SBL367001R1100	36.00...47.0	TF65-47	1SAZ811201R1004	+ 2x	CA4-10	1SBN010110R1010
		100...250	100...250	AF52-30-00-13	1SBL367001R1300						
30	55	24...60	20...60	AF65-30-00-11	1SBL387001R1100	50.0...60.0	TF65-60	1SAZ811201R1006	+ 2x	CA4-01	1SBN010110R1001
		100...250	100...250	AF65-30-00-13	1SBL387001R1300						
37	66	24...60	20...60	AF80-30-00-11	1SBL397001R1100	57.0...68.0	TF96-68	1SAZ911201R1003	+	BER96-4 VM96-4	1SBN083911R1000 1SBN033405T1000
		100...250	100...250	AF80-30-00-13	1SBL397001R1300						
45	80	24...60	20...60	AF96-30-00-11	1SBL407001R1100	75.0...87.0	TF96-87	1SAZ911201R1005	+ 2x	CA4-10 CA4-01	1SBN010110R1010 1SBN010110R1001
		100...250	100...250	AF96-30-00-13	1SBL407001R1300						
55	97	24...60	20...60	AF116-30-11-11	1SFL427001R1111	80...110	TF140DU-110	1SAZ431201R1002	+	BER140-4 VM19	1SFN084211R1000 1SFN030300R1000
		100...250	100...250	AF116-30-11-13	1SFL427001R1311						
75	132	24...60	20...60	AF140-30-11-11	1SFL447001R1111	100...135	TF140DU-135	1SAZ431201R1003			
		100...250	100...250	AF140-30-11-13	1SFL447001R1311						
90	160	24...60	20...60	AF190-30-11-11	1SFL487002R1111	130...175	TA200DU-175	1SAZ421201R1005	+	BER205-4 VM19	1SFN084811R1000 1SFN030300R1000
		100...250	100...250	AF190-30-11-13	1SFL487002R1311						
110	195	24...60	20...60	AF205-30-11-11	1SFL527002R1111	150...200	TA200DU-200	1SAZ421201R1006			
		100...250	100...250	AF205-30-11-13	1SFL527002R1311						

(1) For other control voltages, see "Voltage code table".

Note : for rated power above 110 kW, refer to "Starters protected by electronic overload relays".

# Direct-on-line starters protected by electronic overload relays

## With AF contactors - Open type version in kit form

IEC		Control voltage Uc min. ... Uc max. (1)				Type	Order code	Setting ranges	Type	Order code
AC-3, 400 V Rated power kW	Rated current A	V 50/60 Hz		V DC				A		
		24...60	20...60	100...250	100...250					
4	8.5	24...60	20...60	AF09Z-30-10-21	1SBL136001R2110	5.70...18.9	EF19-18.9	1SAX121001R1105		
		100...250	100...250	AF09-30-10-13	1SBL137001R1310					
5.5	11.5	24...60	20...60	AF12Z-30-10-21	1SBL156001R2110	5.70...18.9	EF19-18.9	1SAX121001R1105		
		100...250	100...250	AF12-30-10-13	1SBL157001R1310					
7.5	15.5	24...60	20...60	AF16Z-30-10-21	1SBL176001R2110	5.70...18.9	EF19-18.9	1SAX121001R1105		
		100...250	100...250	AF16-30-10-13	1SBL177001R1310					
11	22	24...60	20...60	AF26Z-30-00-21	1SBL236001R2100	9.00...30.0	EF45-30	1SAX221001R1101		
		100...250	100...250	AF26-30-00-13	1SBL237001R1300					
15	29	24...60	20...60	AF30Z-30-00-21	1SBL276001R2100	9.00...30.0	EF45-30	1SAX221001R1101		
		100...250	100...250	AF30-30-00-13	1SBL277001R1300					
18.5	35	24...60	20...60	AF38Z-30-00-21	1SBL296001R2100	15.0...45.0	EF45-45	1SAX221001R1102		
		100...250	100...250	AF38-30-00-13	1SBL297001R1300					
18.5	35	24...60	20...60	AF40-30-00-11	1SBL347001R1100	25.0...70.0	EF65-70	1SAX331001R1101		
		100...250	100...250	AF40-30-00-13	1SBL347001R1300					
22	41	24...60	20...60	AF52-30-00-11	1SBL367001R1100	25.0...70.0	EF65-70	1SAX331001R1101		
		100...250	100...250	AF52-30-00-13	1SBL367001R1300					
30	55	24...60	20...60	AF65-30-00-11	1SBL387001R1100	25.0...70.0	EF65-70	1SAX331001R1101		
		100...250	100...250	AF65-30-00-13	1SBL387001R1300					
37	66	24...60	20...60	AF80-30-00-11	1SBL397001R1100	36...100	EF96-100	1SAX341001R1101		
		100...250	100...250	AF80-30-00-13	1SBL397001R1300					
45	80	24...60	20...60	AF96-30-00-11	1SBL407001R1100	36...100	EF96-100	1SAX341001R1101		
		100...250	100...250	AF96-30-00-13	1SBL407001R1300					
55	97	24...60	20...60	AF116-30-11-11	1SFL427001R1111	54...150	EF146-150	1SAX351001R1101		
		100...250	100...250	AF116-30-11-13	1SFL427001R1311					
75	132	24...60	20...60	AF140-30-11-11	1SFL447001R1111	54...150	EF146-150	1SAX351001R1101		
		100...250	100...250	AF140-30-11-13	1SFL447001R1311					
90	160	24...60	20...60	AF190-30-11-11	1SFL487002R1111	63...210	EF205-210	1SAX531001R1101		
		100...250	100...250	AF190-30-11-13	1SFL487002R1311					
110	195	24...60	20...60	AF205-30-11-11	1SFL527002R1111	63...210	EF205-210	1SAX531001R1101		
		100...250	100...250	AF205-30-11-13	1SFL527002R1311					
132	230	24...60	20...60	AF265-30-11-11	1SFL547002R1111	115...380	EF370-380	1SAX611001R1101		
		100...250	100...250	AF265-30-11-13	1SFL547002R1311					
160	280	24...60	20...60	AF305-30-11-11	1SFL587002R1111	115...380	EF370-380	1SAX611001R1101		
		100...250	100...250	AF305-30-11-13	1SFL587002R1311					
200	350	24...60	20...60	AF370-30-11-11	1SFL607002R1111	115...380	EF370-380	1SAX611001R1101		
		100...250	100...250	AF370-30-11-13	1SFL607002R1311					

(1) For other control voltages, see "Voltage code table".



# Reversing starters protected by electronic overload relays

## With AF contactors - Open type version in kit form

IEC		Control voltage				Type	Order code	Electronic overload relays			Accessories	
AC-3, 400 V	Rated power kW	Rated current A	Uc min. ... Uc max. (1)		Type	Order code	Setting ranges A	Type	Order code	Type	Order code	
			V 50/60 Hz	V DC								
4	8.5	8.5	24...60	20...60	AF09Z-30-10-21	1SBL136001R2110	5.70...18.9	EF19-18.9	1SAX121001R1105	+	BER16-4 VEM4	1SBN081311R1000 1SBN030111R1000
			100...250	100...250	AF09-30-10-13	1SBL137001R1310						
5.5	11.5	11.5	24...60	20...60	AF12Z-30-10-21	1SBL156001R2110	5.70...18.9	EF19-18.9	1SAX121001R1105			
			100...250	100...250	AF12-30-10-13	1SBL157001R1310						
7.5	15.5	15.5	24...60	20...60	AF16Z-30-10-21	1SBL176001R2110	5.70...18.9	EF19-18.9	1SAX121001R1105			
			100...250	100...250	AF16-30-10-13	1SBL177001R1310						
11	22	22	24...60	20...60	AF26Z-30-00-21	1SBL236001R2100	9.00...30.0	EF45-30	1SAX221001R1101	+	BER38-4 VEM4	1SBN082311R1000 1SBN030111R1000
			100...250	100...250	AF26-30-00-13	1SBL237001R1300						
15	29	29	24...60	20...60	AF30Z-30-00-21	1SBL276001R2100	9.00...30.0	EF45-30	1SAX221001R1101	+ 2x	CA4-10	1SBN010110R1010
			100...250	100...250	AF30-30-00-13	1SBL277001R1300						
18.5	35	35	24...60	20...60	AF38Z-30-00-21	1SBL296001R2100	15.0...45.0	EF45-45	1SAX221001R1102			
			100...250	100...250	AF38-30-00-13	1SBL297001R1300						
18.5	35	35	24...60	20...60	AF40-30-00-11	1SBL347001R1100	25.0...70.0	EF65-70	1SAX331001R1101	+	BER65-4 VM96-4	1SBN083411R1000 1SBN033405T1000
			100...250	100...250	AF40-30-00-13	1SBL347001R1300						
22	41	41	24...60	20...60	AF52-30-00-11	1SBL367001R1100	25.0...70.0	EF65-70	1SAX331001R1101	+ 2x	CA4-10	1SBN010110R1010
			100...250	100...250	AF52-30-00-13	1SBL367001R1300						
30	55	55	24...60	20...60	AF65-30-00-11	1SBL387001R1100	25.0...70.0	EF65-70	1SAX331001R1101	+ 2x	CA4-01	1SBN010110R1001
			100...250	100...250	AF65-30-00-13	1SBL387001R1300						
37	66	66	24...60	20...60	AF80-30-00-11	1SBL397001R1100	36...100	EF96-100	1SAX341001R1101	+	BER96-4 VM96-4	1SBN083911R1000 1SBN033405T1000
			100...250	100...250	AF80-30-00-13	1SBL397001R1300						
45	80	80	24...60	20...60	AF96-30-00-11	1SBL407001R1100	36...100	EF96-100	1SAX341001R1101	+ 2x	CA4-10 CA4-01	1SBN010110R1010 1SBN010110R1001
			100...250	100...250	AF96-30-00-13	1SBL407001R1300						
55	97	97	24...60	20...60	AF116-30-11-11	1SFL427001R1111	54...150	EF146-150	1SAX351001R1101	+	BER140-4 VM19	1SFN084211R1000 1SFN030300R1000
			100...250	100...250	AF116-30-11-13	1SFL427001R1311						
75	132	132	24...60	20...60	AF140-30-11-11	1SFL447001R1111	54...150	EF146-150	1SAX351001R1101			
			100...250	100...250	AF140-30-11-13	1SFL447001R1311						
90	160	160	24...60	20...60	AF190-30-11-11	1SFL487002R1111	63...210	EF205-210	1SAX531001R1101	+	BER205-4 VM19	1SFN084811R1000 1SFN030300R1000
			100...250	100...250	AF190-30-11-13	1SFL487002R1311						
110	195	195	24...60	20...60	AF205-30-11-11	1SFL527002R1111	63...210	EF205-210	1SAX531001R1101			
			100...250	100...250	AF205-30-11-13	1SFL527002R1311						
132	230	230	24...60	20...60	AF265-30-11-11	1SFL547002R1111	115...380	EF370-380	1SAX611001R1101	+	BER370-4 VM19	1SFN085411R1000 1SFN030300R1000
			100...250	100...250	AF265-30-11-13	1SFL547002R1311						
160	280	280	24...60	20...60	AF305-30-11-11	1SFL587002R1111	115...380	EF370-380	1SAX611001R1101			
			100...250	100...250	AF305-30-11-13	1SFL587002R1311						
200	350	350	24...60	20...60	AF370-30-11-11	1SFL607002R1111	115...380	EF370-380	1SAX611001R1101			
			100...250	100...250	AF370-30-11-13	1SFL607002R1311						

(1) For other control voltages, see "Voltage code table".

# Star-delta starters protected by overload relays

## With AF contactors - Open type version in kit form

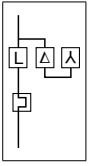

1SFC101103V0001

AF16-30-10 + AF16-30-10 +  
AF09-30-10 + BEY16-4 + VEM4 +  
TF42



1SFC101104V0001

AF140-30-11 + AF140-30-11 +  
AF140-30-11 + BEY140-4 + VM19  
+ EF146

### Mounting positions

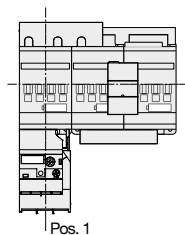

### Application

Star-delta starting is the most common method to reduce the starting current of a motor.

This system can be used on all the squirrel cage motors, which are normally used in delta connection. In this type of starting, it is recommended to choose motors having high starting torque i.e. much higher than the resistive torque in order to reach sufficient high speed when the motor is connected in star.

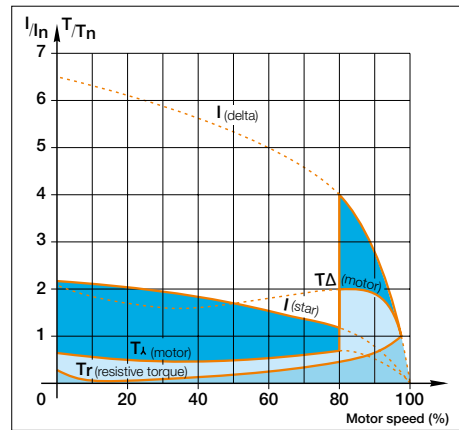

I = current  
T = torque  
 $I_n$  = nominal current  
 $T_n$  = nominal torque

### When starting:

- Inrush current is reduced to a third of direct starting current
- Motor torque is reduced to a third or even less of direct starting torque.

Transient current is generated when switching from star to delta connection.

During the initial starting phase ("star" connection), the resistive torque of the driven load must remain, irrespective of speed, less than the "star" motor torque until "star-delta" switching occurs.

This starting mode is therefore ideal for machines having low starting torque such as pumps, centrifugal compressors, wood-working machines...

### Precaution

- Motor nominal voltage in delta connection must be equal to that of the mains. Example: a motor for 400 V star-delta starting must be designed for 400 V in "delta" connection. Its usual designation is "400 V / 690 V motor". The motor must be constructed with 6 terminal windings
- In order to prevent a high current peak, at least 85 % of nominal speed must be reached before switching from star to delta

### Sequence

Starting is a three-stage process:

**1st stage:** "Star" connection - Press the "On" button on the control circuit to close the KM2 "Star" contactor. The KM1 "line" contactor then closes and the motor starts. Countdown of programmed starting time (6 to 10 s) then begins.

**2nd stage:** "Star" to "Delta" switching - when programmed starting time is over, the KM2 "Star" contactor opens.

**3rd stage:** "Delta" connection - Thanks to AF contactors, a transition time (or dwelling time) of 50 ms is already integrated between the opening of the "star" contactor and closing of the "delta" contactor.

**Conclusion:** An on-delay timer without dwelling time (e.g.: CT-ERS.21S or TEF4-ON) is enough to count-down the programmed starting time (6 to 10 s) during "Star connection". The use of a star-delta timer including a dwelling time is not permitted.

### Main Technical Data

Standards	IEC 60947-4-1 / EN 60947-4-1
Rated operational voltage $U_e$ max.	690 V - 50/60 Hz
Rated insulation voltage $U_i$	
acc. to IEC 60947-4-1	690 V
acc. to UL / CSA	600 V
Ambient air temperature	
Close to the device	$\leq 60^\circ\text{C}$ (TF42: 38 A above $\leq 50^\circ\text{C}$ )
Degree of protection	IP20
Switching frequency	Refer to "Switching frequency diagrams" page

# Star-delta starters protected by overload relays

## With AF contactors - Open type version in kit form

### Description

You can easily assemble star-delta starter thanks to our complete range of accessories:

- For AF09 ... AF38, use VEM4 mechanical and electrical interlock set without increasing starter width. It includes:
  - VM4 mechanical interlock unit and 2 fixing clips
  - VE4 electrical interlock block with A2-A2 connection.
- For AF40 ... AF370, use VM mechanical interlock unit and additional auxiliary contact blocks for electrical interlocking.
- BEY...-4 connection set: it assures a safe and simple connection between both contactor main terminals.

Select now easily and quickly your starter in the following pages at 400 V, up to 200 kW.

For the full coordination tables: [www.abb.com/lowvoltage](http://www.abb.com/lowvoltage) then go to the right menu: "Support", select: "Online Product Selection Tools" then select "Coordination Tables for motor protection"

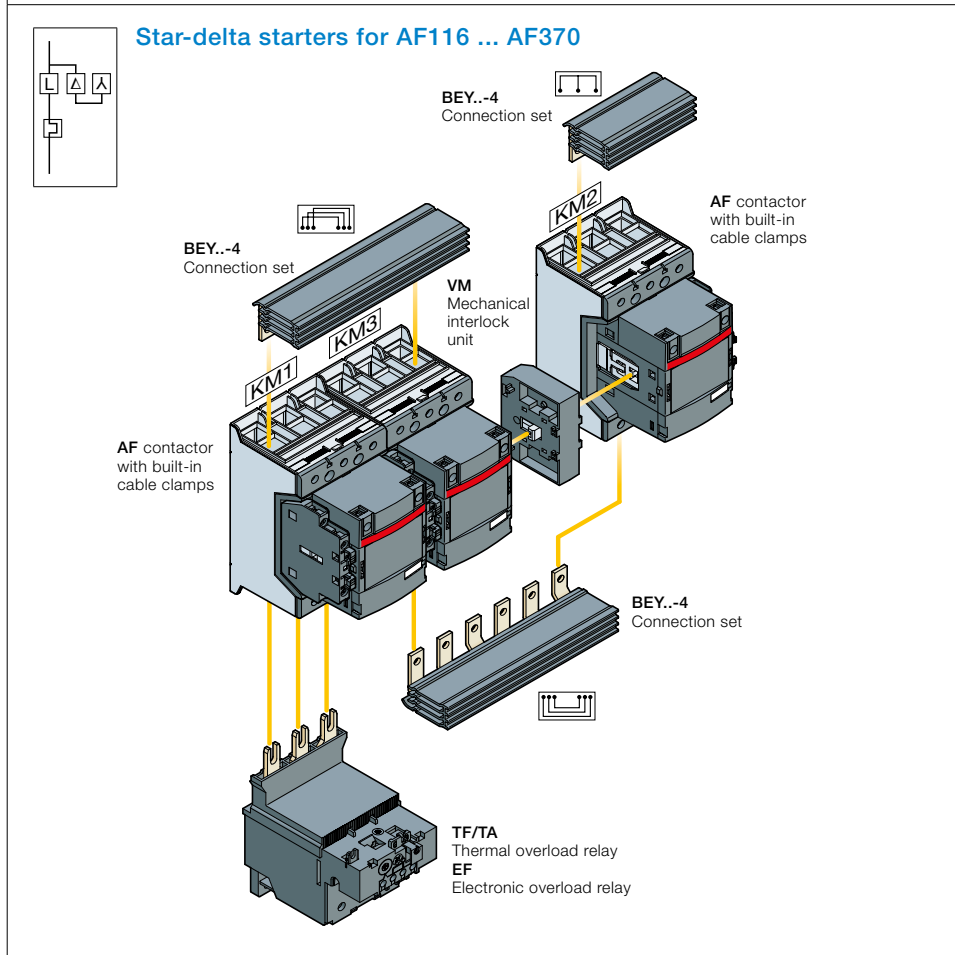
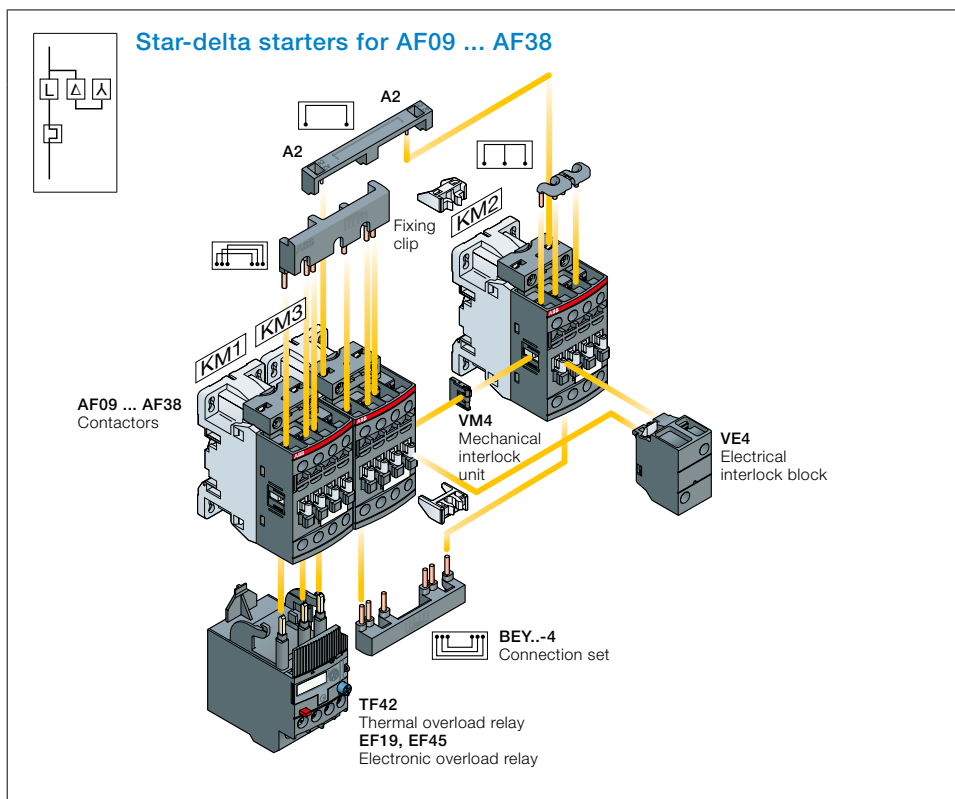

# Star-delta starters protected by thermal overload relays

## With AF contactors - Open type version in kit form

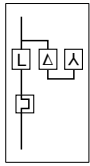

**Line contactor KM1**

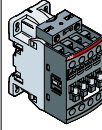

**Delta contactor KM3**

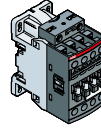

**Star contactor KM2**

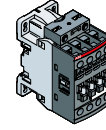

IEC AC-3 Rated power										Control voltage Uc min. ... Uc max. (1)		Type	Order code	Type	Order code	Type	Order code
220 V	230/240 V	380 V	400 V	415 V	440 V	500 V	690 V	400 V	Rated current	V 50/60 Hz	V DC						
kW	kW	kW	kW	kW	kW	kW	kW	A									
4	4	7.5	7.5	7.5	7.5	9	9	15.5	24...60 100...250	20...60 100...250		AF09Z-30-10-21 AF09-30-10-13	1SBL136001R2110 1SBL137001R1310	AF09Z-30-10-21 AF09-30-10-13	1SBL136001R2110 1SBL137001R1310	AF09Z-30-10-21 AF09-30-10-13	1SBL136001R2110 1SBL137001R1310
5.5	5.5	9	11	11	11	11	11	22	24...60 100...250	20...60 100...250		AF12Z-30-10-21 AF12-30-10-13	1SBL156001R2110 1SBL157001R1310	AF12Z-30-10-21 AF12-30-10-13	1SBL156001R2110 1SBL157001R1310	AF09Z-30-10-21 AF09-30-10-13	1SBL136001R2110 1SBL137001R1310
7.5	9	15	15	15	15	15	15	29	24...60 100...250	20...60 100...250		AF16Z-30-10-21 AF16-30-10-13	1SBL176001R2110 1SBL177001R1310	AF16Z-30-10-21 AF16-30-10-13	1SBL176001R2110 1SBL177001R1310	AF09Z-30-10-21 AF09-30-10-13	1SBL136001R2110 1SBL137001R1310
11	11	18.5	18.5	25	25	25	25	35	24...60 100...250	20...60 100...250		AF26Z-30-00-21 AF26-30-00-13	1SBL236001R2100 1SBL237001R1300	AF26Z-30-00-21 AF26-30-00-13	1SBL236001R2100 1SBL237001R1300	AF26Z-30-00-21 AF26-30-00-13	1SBL236001R2100 1SBL237001R1300
11	11	22	22	25	25	25	25	41	24...60 100...250	20...60 100...250		AF26Z-30-00-21 AF26-30-00-13	1SBL236001R2100 1SBL237001R1300	AF26Z-30-00-21 AF26-30-00-13	1SBL236001R2100 1SBL237001R1300	AF26Z-30-00-21 AF26-30-00-13	1SBL236001R2100 1SBL237001R1300
11	15	25	25	25	25	30	30	47	24...60 100...250	20...60 100...250		AF30Z-30-00-21 AF30-30-00-13	1SBL276001R2100 1SBL277001R1300	AF30Z-30-00-21 AF30-30-00-13	1SBL276001R2100 1SBL277001R1300	AF26Z-30-00-21 AF26-30-00-13	1SBL236001R2100 1SBL237001R1300
18.5	18.5	37	37	37	37	37	37	66	24...60 100...250	20...60 100...250		AF40-30-00-11 AF40-30-00-13	1SBL347001R1100 1SBL347001R1300	AF40-30-00-11 AF40-30-00-13	1SBL347001R1100 1SBL347001R1300	AF40-30-00-11 AF40-30-00-13	1SBL347001R1100 1SBL347001R1300
25	25	45	45	45	45	45	45	80	24...60 100...250	20...60 100...250		AF52-30-00-11 AF52-30-00-13	1SBL367001R1100 1SBL367001R1300	AF52-30-00-11 AF52-30-00-13	1SBL367001R1100 1SBL367001R1300	AF40-30-00-11 AF40-30-00-13	1SBL347001R1100 1SBL347001R1300
30	30	55	55	55	55	55	55	97	24...60 100...250	20...60 100...250		AF65-30-00-11 AF65-30-00-13	1SBL387001R1100 1SBL387001R1300	AF65-30-00-11 AF65-30-00-13	1SBL387001R1100 1SBL387001R1300	AF40-30-00-11 AF40-30-00-13	1SBL347001R1100 1SBL347001R1300
37	37	75	75	75	75	75	75	132	24...60 100...250	20...60 100...250		AF80-30-00-11 AF80-30-00-13	1SBL397001R1100 1SBL397001R1300	AF80-30-00-11 AF80-30-00-13	1SBL397001R1100 1SBL397001R1300	AF52-30-00-11 AF52-30-00-13	1SBL367001R1100 1SBL367001R1300
45	45	90	90	90	90	90	90	160	24...60 100...250	20...60 100...250		AF96-30-00-11 AF96-30-00-13	1SBL407001R1100 1SBL407001R1300	AF96-30-00-11 AF96-30-00-13	1SBL407001R1100 1SBL407001R1300	AF65-30-00-11 AF65-30-00-13	1SBL387001R1100 1SBL387001R1300
55	55	90	110	110	132	132	110	195	24...60 100...250	20...60 100...250		AF116-30-11-11 AF116-30-11-13	1SFL427001R1111 1SFL427001R1311	AF116-30-11-11 AF116-30-11-13	1SFL427001R1111 1SFL427001R1311	AF116-30-11-11 (4) AF116-30-11-13	1SFL427001R1111 1SFL427001R1311
75	75	132	132	132	132	160	132	230	24...60 100...250	20...60 100...250		AF140-30-11-11 AF140-30-11-13	1SFL447001R1111 1SFL447001R1311	AF140-30-11-11 AF140-30-11-13	1SFL447001R1111 1SFL447001R1311	AF116-30-11-11 AF116-30-11-13	1SFL427001R1111 1SFL427001R1311
90	90	160	160	160	160	200	200	280	24...60 100...250	20...60 100...250		AF190-30-11-11 AF190-30-11-13	1SFL487002R1111 1SFL487002R1311	AF190-30-11-11 AF190-30-11-13	1SFL487002R1111 1SFL487002R1311	AF140-30-11-11 AF140-30-11-13	1SFL447001R1111 1SFL447001R1311

(1) AF09 ... AF190: ambient temperature ≤ 60 °C.



(2) The setting current value is: nominal motor current x 0.58. Overload relay type given for 400 V - AC-3.

For other voltage, select overload relay type according to required nominal motor current x 0.58.

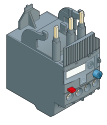
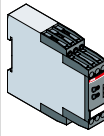
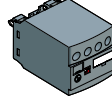
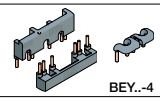
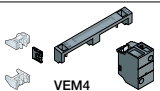

(3) On-delay timer without dwelling-time (e.g.: side-mounted CT-ERS.21S or front-mounted TEF4-ON) is enough to countdown the programmed starting time during "Star connection".

In case of use of front-mounted TEF4-ON on-delay timer, mount on KM1 contactor AF26 ... AF96 a side-mounted CAL4-11 auxiliary contact block instead of CA4-10 auxiliary contact block.

(4) AF80 can also be used, but no connection set and mechanical interlock is available for this combination.

Thermal overload relays (2)			Electronic timers (3)			Accessories			Auxiliary contact blocks		
			 CT-ERS  TEF4-ON Uc = 24...240 V 50/60 Hz or DC			 BEY..-4   VEM4			 CA4		
Setting ranges	Type	Order code	Type	Order code	Type	Order code	Type	Order code			
A											
7.60...10.0	TF42-10	1SAZ721201R1043	CT-ERS.21S or TEF4-ON	1SVR730100R0300 1SBN020112R1000	BEY16-4 + VEM4	1SBN081313R2000 1SBN030111R1000	-	-			
10.0...13.0	TF42-13	1SAZ721201R1045	CT-ERS.21S or TEF4-ON	1SVR730100R0300 1SBN020112R1000	BEY16-4 + VEM4	1SBN081313R2000 1SBN030111R1000	-	-			
16.0...20.0	TF42-20	1SAZ721201R1049	CT-ERS.21S or TEF4-ON	1SVR730100R0300 1SBN020112R1000	BEY16-4 + VEM4	1SBN081313R2000 1SBN030111R1000	-	-			
20.0...24.0	TF42-24	1SAZ721201R1051	CT-ERS.21S or TEF4-ON	1SVR730100R0300 1SBN020112R1000	BEY38-4 + VEM4	1SBN082713R2000 1SBN030111R1000	KM1 : 1 x CA4-10 KM2 : 1 x CA4-10	1SBN010110R1010 1SBN010110R1010			
20.0...24.0	TF42-24	1SAZ721201R1051	CT-ERS.21S or TEF4-ON	1SVR730100R0300 1SBN020112R1000	BEY38-4 + VEM4	1SBN082713R2000 1SBN030111R1000	KM1 : 1 x CA4-10 KM2 : 1 x CA4-10	1SBN010110R1010 1SBN010110R1010			
24.0...29.0	TF42-29	1SAZ721201R1052	CT-ERS.21S or TEF4-ON	1SVR730100R0300 1SBN020112R1000	BEY38-4 + VEM4	1SBN082713R2000 1SBN030111R1000	KM1 : 1 x CA4-10 KM2 : 1 x CA4-10	1SBN010110R1010 1SBN010110R1010			
30.0...40.0	TF65-40	1SAZ811201R1003	CT-ERS.21S or TEF4-ON	1SVR730100R0300 1SBN020112R1000	BEY65-4 + VM96-4	1SBN083413R2000 1SBN033405T1000	KM1 : 1 x CA4-10 (3) KM2 : 1 x CA4-10 1 x CA4-01 KM3 : 1 x CA4-01	1SBN010110R1010 1SBN010110R1010 1SBN010110R1001 1SBN010110R1001			
36.0...47.0	TF65-47	1SAZ811201R1004	CT-ERS.21S or TEF4-ON	1SVR730100R0300 1SBN020112R1000	BEY65-4 + VM96-4	1SBN083413R2000 1SBN033405T1000	KM1 : 1 x CA4-10 (3) KM2 : 1 x CA4-10 1 x CA4-01 KM3 : 1 x CA4-01	1SBN010110R1010 1SBN010110R1010 1SBN010110R1001 1SBN010110R1001			
50.0...60.0	TF65-60	1SAZ811201R1006	CT-ERS.21S or TEF4-ON	1SVR730100R0300 1SBN020112R1000	BEY65-4 + VM96-4	1SBN083413R2000 1SBN033405T1000	KM1 : 1 x CA4-10 (3) KM2 : 1 x CA4-10 1 x CA4-01 KM3 : 1 x CA4-01	1SBN010110R1010 1SBN010110R1010 1SBN010110R1001 1SBN010110R1001			
65.0...78.0	TF96-78	1SAZ911201R1004	CT-ERS.21S or TEF4-ON	1SVR730100R0300 1SBN020112R1000	BEY96-4 + VM96-4	1SBN083913R2000 1SBN033405T1000	KM1 : 1 x CA4-10 (3) KM2 : 1 x CA4-10 1 x CA4-01 KM3 : 1 x CA4-01	1SBN010110R1010 1SBN010110R1010 1SBN010110R1001 1SBN010110R1001			
84.0...96.0	TF96-96	1SAZ911201R1006	CT-ERS.21S or TEF4-ON	1SVR730100R0300 1SBN020112R1000	BEY96-4 + VM96-4	1SBN083913R2000 1SBN033405T1000	KM1 : 1 x CA4-10 (3) KM2 : 1 x CA4-10 1 x CA4-01 KM3 : 1 x CA4-01	1SBN010110R1010 1SBN010110R1010 1SBN010110R1001 1SBN010110R1001			
100...135	TF140DU-135	1SAZ431201R1003	CT-ERS.21S	1SVR730100R0300	BEY140-4 + VM19	1SFN084413R1000 1SFN030300R1000	-	-			
100...135	TF140DU-135	1SAZ431201R1003	CT-ERS.21S	1SVR730100R0300	BEY140-4 + VM19	1SFN084413R1000 1SFN030300R1000	-	-			
130...175	TA200DU-175	1SAZ421201R1005	CT-ERS.21S	1SVR730100R0300	BEY190-4 + VM140/190	1SFN084813R1000 1SFN034403R1000	-	-			

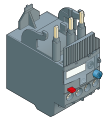
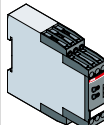
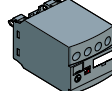
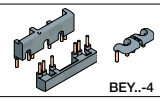
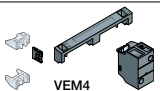

Electronic overload relays (2)			Electronic timers (3)			Accessories			Auxiliary contact blocks		
			 CT-ERS  TEF4-ON Uc = 24...240 V 50/60 Hz or DC			 BEY..-4   VEM4			 CA4		
Setting ranges	Type	Order code	Type	Order code	Type	Order code	Type	Order code	Type	Order code	
A											
5.70...18.9	EF19-18.9	1SAX121001R1105	CT-ERS.21S or TEF4-ON	1SVR730100R0300 1SBN020112R1000	BEY16-4 + VEM4	1SBN081313R2000 1SBN030111R1000	-	-	-	-	
5.70...18.9	EF19-18.9	1SAX121001R1105	CT-ERS.21S or TEF4-ON	1SVR730100R0300 1SBN020112R1000	BEY16-4 + VEM4	1SBN081313R2000 1SBN030111R1000	-	-	-	-	
5.70...18.9	EF19-18.9	1SAX121001R1105	CT-ERS.21S or TEF4-ON	1SVR730100R0300 1SBN020112R1000	BEY16-4 + VEM4	1SBN081313R2000 1SBN030111R1000	-	-	-	-	
9.00...30.0	EF45-30	1SAX221001R1101	CT-ERS.21S or TEF4-ON	1SVR730100R0300 1SBN020112R1000	BEY38-4 + VEM4	1SBN082713R2000 1SBN030111R1000	KM1 : 1 x CA4-10 KM2 : 1 x CA4-10	1SBN010110R1010 1SBN010110R1010			
9.00...30.0	EF45-30	1SAX221001R1101	CT-ERS.21S or TEF4-ON	1SVR730100R0300 1SBN020112R1000	BEY38-4 + VEM4	1SBN082713R2000 1SBN030111R1000	KM1 : 1 x CA4-10 KM2 : 1 x CA4-10	1SBN010110R1010 1SBN010110R1010			
9.00...30.0	EF45-30	1SAX221001R1101	CT-ERS.21S or TEF4-ON	1SVR730100R0300 1SBN020112R1000	BEY38-4 + VEM4	1SBN082713R2000 1SBN030111R1000	KM1 : 1 x CA4-10 KM2 : 1 x CA4-10	1SBN010110R1010 1SBN010110R1010			
25...70	EF65-70	1SAX331001R1101	CT-ERS.21S or TEF4-ON	1SVR730100R0300 1SBN020112R1000	BEY65-4 + VM96-4	1SBN083413R2000 1SBN033405T1000	KM1 : 1 x CA4-10 (3) KM2 : 1 x CA4-10 1 x CA4-01 KM3 : 1 x CA4-01	1SBN010110R1010 1SBN010110R1010 1SBN010110R1001 1SBN010110R1001			
25...70	EF65-70	1SAX331001R1101	CT-ERS.21S or TEF4-ON	1SVR730100R0300 1SBN020112R1000	BEY65-4 + VM96-4	1SBN083413R2000 1SBN033405T1000	KM1 : 1 x CA4-10 (3) KM2 : 1 x CA4-10 1 x CA4-01 KM3 : 1 x CA4-01	1SBN010110R1010 1SBN010110R1010 1SBN010110R1001 1SBN010110R1001			
25...70	EF65-70	1SAX331001R1101	CT-ERS.21S or TEF4-ON	1SVR730100R0300 1SBN020112R1000	BEY65-4 + VM96-4	1SBN083413R2000 1SBN033405T1000	KM1 : 1 x CA4-10 (3) KM2 : 1 x CA4-10 1 x CA4-01 KM3 : 1 x CA4-01	1SBN010110R1010 1SBN010110R1010 1SBN010110R1001 1SBN010110R1001			
36...100	EF96-100	1SAX341001R1101	CT-ERS.21S or TEF4-ON	1SVR730100R0300 1SBN020112R1000	BEY96-4 + VM96-4	1SBN083913R2000 1SBN033405T1000	KM1 : 1 x CA4-10 (3) KM2 : 1 x CA4-10 1 x CA4-01 KM3 : 1 x CA4-01	1SBN010110R1010 1SBN010110R1010 1SBN010110R1001 1SBN010110R1001			
36...100	EF96-100	1SAX341001R1101	CT-ERS.21S or TEF4-ON	1SVR730100R0300 1SBN020112R1000	BEY96-4 + VM96-4	1SBN083913R2000 1SBN033405T1000	KM1 : 1 x CA4-10 (3) KM2 : 1 x CA4-10 1 x CA4-01 KM3 : 1 x CA4-01	1SBN010110R1010 1SBN010110R1010 1SBN010110R1001 1SBN010110R1001			
54...150	EF146-150	1SAX351001R1101	CT-ERS.21S	1SVR730100R0300	BEY140-4 + VM19	1SFN084413R1000 1SFN030300R1000	-	-	-	-	
54...150	EF146-150	1SAX351001R1101	CT-ERS.21S	1SVR730100R0300	BEY140-4 + VM19	1SFN084413R1000 1SFN030300R1000	-	-	-	-	
63...210	EF205-210	1SAX531001R1101	CT-ERS.21S	1SVR730100R0300	BEY190-4 + VM140/190	1SFN084813R1000 1SFN034403R1000	-	-	-	-	
63...210	EF205-210	1SAX531001R1101	CT-ERS.21S	1SVR730100R0300	BEY205-4 + VM19	1SFN085213R1000 1SFN030300R1000	-	-	-	-	
115...380	EF370-380	1SAX611001R1101	CT-ERS.21S	1SVR730100R0300	BEY265-4 + VM205/265	1SFN085413R1000 1SFN035203R1000	-	-	-	-	
115...380	EF370-380	1SAX611001R1101	CT-ERS.21S	1SVR730100R0300	BEY370-4 + VM19	1SFN085813R1000 1SFN030300R1000	-	-	-	-	
115...380	EF370-380	1SAX611001R1101	CT-ERS.21S	1SVR730100R0300	BEY370-4 + VM19	1SFN085813R1000 1SFN030300R1000	-	-	-	-	

# 3-pole contactors, for motor control and power switching



AC / DC Control supply				Type	AF09	AF12	AF16	AF26	AF30	AF38	AF40	AF52	AF65	AF80	AF96
IEC	AC-3	Rated operational power	220 - 230 - 240 V	kW	2.2	3	4	6.5	9	11	11	15	18.5	22	25
		$\theta \leq 60^\circ\text{C}$ for AF09 ... AF370	<b>380 - 400 V</b>	<b>kW</b>	<b>4</b>	<b>5.5</b>	<b>7.5</b>	<b>11</b>	<b>15</b>	<b>18.5</b>	<b>18.5</b>	<b>22</b>	<b>30</b>	<b>37</b>	<b>45</b>
		$\theta \leq 55^\circ\text{C}$ for AF400 ... AF2650	415 V	kW	4	5.5	9	11	15	18.5	22	30	37	45	55
			440 V	kW	4	5.5	9	15	18.5	22	22	30	37	45	55
			500 V	kW	5.5	7.5	9	15	18.5	22	22	30	37	45	55
			690 V	kW	5.5	7.5	9	15	18.5	22	22	30	37	45	55
			1000 V	kW	—	—	—	—	—	—	—	—	—	—	35
	Rated operational current	<b>380 - 400 V</b>	<b>A</b>	<b>9</b>	<b>12</b>	<b>18</b>	<b>26</b>	<b>32</b>	<b>38</b>	<b>40</b>	<b>53</b>	<b>65</b>	<b>80</b>	<b>96</b>	
AC-1	Rated operational current	$\theta \leq 40^\circ\text{C}$ , 690 V	<b>A</b>	<b>25</b>	<b>28</b>	<b>30</b>	<b>45</b>	<b>50</b>	<b>50</b>	<b>70</b>	<b>100</b>	<b>105</b>	<b>125</b>	<b>130</b>	

UL / CSA	1-phase motor rating	120 V	hp	0.75	1	1.5	2	2	2	3	3	5	7.5	7.5
		240 V	hp	1.5	2	3	3	5	5	7.5	10	15	15	20
	3-phase motor rating	200 - 208 V	hp	2	3	5	7.5	10	10	10	15	20	25	30
		220 - 240 V	hp	2	3	5	7.5	10	10	15	20	25	30	30
		<b>440 - 480 V</b>	<b>hp</b>	<b>5</b>	<b>7.5</b>	<b>10</b>	<b>15</b>	<b>20</b>	<b>25</b>	<b>30</b>	<b>40</b>	<b>50</b>	<b>60</b>	<b>60</b>
		550 - 600 V	hp	7.5	10	15	20	25	30	40	50	60	75	75
	General use rating	<b>600 V</b>	<b>A</b>	<b>25</b>	<b>28</b>	<b>30</b>	<b>45</b>	<b>50</b>	<b>50</b>	<b>60</b>	<b>80</b>	<b>90</b>	<b>105</b>	<b>115</b>
NEMA	NEMA Size			<b>00</b>	<b>0</b>	—	<b>1</b>	—	—	<b>2</b>	—	—	<b>3</b>	—

## Main accessories

Auxiliary contact blocks	Front mounting	<b>CA4-10</b> (1 x N.O.) <b>CA4-01</b> (1 x N.C.)
	Side mounting	<b>CAL4-11</b> (1 x N.O. + 1 x N.C.)
Timers	Electronic	<b>TEF4-ON</b> <b>TEF4-OFF</b>
Interlocking units	Mechanical	<b>VM4</b>
	Mechanical / Electrical	<b>VM96-4</b>
Connection sets	For reversing contactors	<b>VEM4</b>
Surge suppressors		<b>BER16-4</b> <b>BER38-4</b> <b>BER65-4</b> <b>BER96-4</b>
		Built-in surge protection

## Overload relays

Thermal relays	 Class 10 (Class 10A for TF140, TA200DU)	<b>TF42</b> (0.10...38 A)	<b>TF65</b> (22...67 A)	<b>TF96</b> (40...96 A)
Electronic relays	Class 10E, 20E, 30E	<b>EF19</b> (0.10...18.9 A)	<b>EF19</b> (0.10...18.9 A) <b>EF45</b> (9...45 A)	<b>EF65</b> (20...70 A) <b>EF96</b> (36...100 A)

## Manual motor starters

	Thermal / magnetic protection Class 10	<b>MS116</b> (0.10...32 A) Ics up to 50 kA for class 10 A	<b>MS450</b> (28...50 A) Ics up to 50 kA
		<b>MS132</b> (0.10...32 A) Ics up to 100 kA	<b>MS495</b> (45...100 A) Ics up to 50 kA
	Magnetic only types	<b>MO132</b> (0.16...32 A) Ics up to 100 kA	<b>MS497</b> (22...100 A) Ics up to 100 kA
			<b>MO496</b> (32...100 A) Ics up to 100 kA
			<b>MO450</b> (40...50 A) Ics up to 50 kA
Accessories	For contactor mounting	<b>BEA16-4</b> <b>BEA38-4</b>	<b>MO495</b> (63...100 A) Ics up to 50 kA





	AF116	AF140	AF146	AF190	AF205	AF265	AF305	AF370	AF400	AF460	AF580	AF750	AF1250	AF1350	AF1650	AF2050	AF2650
	30	37	45	55	55	75	90	110	110	132	160	220	—	257	315	—	—
	<b>55</b>	<b>75</b>	<b>75</b>	<b>90</b>	<b>110</b>	<b>132</b>	<b>160</b>	<b>200</b>	<b>200</b>	<b>250</b>	<b>315</b>	<b>400</b>	—	<b>475</b>	<b>560</b>	—	—
	55	75	75	90	110	132	160	200	220	250	355	425	—	500	630	—	—
	75	90	90	110	132	160	160	200	220	250	355	450	—	560	710	—	—
	75	90	90	110	132	160	200	250	250	315	400	520	—	560	710	—	—
	55	75	90	132	160	200	250	315	315	355	500	600	—	800	1000	—	—
	—	—	75	110	132	132	132	132	220	280	355	400	—	—	—	—	—
	<b>116</b>	<b>140</b>	<b>146</b>	<b>190</b>	<b>205</b>	<b>265</b>	<b>305</b>	<b>370</b>	<b>400</b>	<b>460</b>	<b>580</b>	<b>750</b>	—	<b>860</b>	<b>1060</b>	—	—
	<b>160</b>	<b>200</b>	<b>225</b>	<b>275</b>	<b>350</b>	<b>400</b>	<b>500</b>	<b>600</b>	<b>600</b>	<b>700</b>	<b>800</b>	<b>1050</b>	<b>1260</b>	<b>1350</b>	<b>1650</b>	<b>2050</b>	<b>2650</b>

—	—	—	—	—	—	—	—	—	—	—	—	—	—	—	—	—	—
—	—	—	—	—	—	—	—	—	—	—	—	—	—	—	—	—	—
30	40	40	50	60	75	100	125	125	150	150	200	250	—	—	—	—	—
40	50	50	60	75	100	125	150	150	200	250	300	—	—	400	450	—	—
<b>75</b>	<b>100</b>	<b>100</b>	<b>125</b>	<b>150</b>	<b>200</b>	<b>250</b>	<b>300</b>	<b>350</b>	<b>400</b>	<b>500</b>	<b>600</b>	—	—	<b>800</b>	<b>900</b>	—	—
100	125	125	150	200	250	300	350	400	500	600	700	—	—	1000	1150	—	—
<b>160</b>	<b>200</b>	<b>200</b>	<b>250</b>	<b>300</b>	<b>350</b>	<b>400</b>	<b>520</b>	<b>550</b>	<b>650</b>	<b>750</b>	<b>900</b>	<b>1210</b>	—	<b>1350</b>	<b>1650</b>	<b>2100</b>	<b>2700</b>
—	<b>4</b>	—	—	—	<b>5</b>	—	—	—	<b>6</b>	—	<b>7</b>	—	—	<b>8</b>	—	—	—

CAL19-11 (1 x N.O. + 1 x N.C.)

CAL18-11 (1 x N.O. + 1 x N.C.)

VM19 (for same size contactors)

VM750H  
VM750V

VM1650H

BER140-4

BER205-4

BER370-4

BEM460-30

BEM750-30

TF140DU (66...142 A)  
 $\theta \leq 55^\circ\text{C}$

TA200DU (66...200 A)  
 $\theta \leq 55^\circ\text{C}$

EF146 (54...150 A)

EF205 (63...210 A)

EF370 (115...380 A)

EF460 (150...500 A)

EF750 (250...800 A)

E1250DU (375...1250 A)

## Short-circuit protection devices

### MCCB and switch-fuses



# AF09 ... AF38 3-pole contactors

## 4 to 18.5 kW

### AC / DC operated



AF09-30-10



AF26-30-00

#### Description

AF09 ... AF38 contactors are mainly used for controlling 3-phase motors and power circuits up to 690 V AC and 220 V DC. These contactors are of the block type design with 3 main poles.

- control circuit: AC or DC operated with electronic coil interface accepting a wide control voltage range (e.g. 100...250 V AC and DC), only 4 control voltage ranges covering 24...500V 50/60 Hz and 20...500 V DC
- can manage large control voltage variations
- reduced panel energy consumption
- very distinct closing and opening.
- built-in surge suppression
- add-on auxiliary contact blocks for front or side mounting and a wide range of accessories.

#### Ordering details

IEC		UL/CSA		Rated control circuit voltage		Auxiliary contacts fitted	Type (1)	Order code	Weight					
Rated operational power	current	3-phase motor rating	General use rating	Uc min. ... Uc max.										
400 V AC-3	$\theta \leq 40^\circ\text{C}$	480 V	600 V AC	V 50/60 Hz	V DC				Pkg (1 pce)					
kW	A	hp	A						kg					
4	25	5	25	24...60	-	(2)	1 0	AF09-30-10-41	1SBL137001R4110	0.270				
							0 1	AF09-30-01-41	1SBL137001R4101	0.270				
				48...130	48...130		1 0	AF09-30-10-12	1SBL137001R1210	0.270				
							0 1	AF09-30-01-12	1SBL137001R1201	0.270				
				100...250	100...250		1 0	AF09-30-10-13	1SBL137001R1310	0.270				
							0 1	AF09-30-01-13	1SBL137001R1301	0.270				
				250...500	250...500		1 0	AF09-30-10-14	1SBL137001R1410	0.310				
							0 1	AF09-30-01-14	1SBL137001R1401	0.310				
				5.5	28	7.5	28	24...60	-	(2)	1 0	AF12-30-10-41	1SBL157001R4110	0.270
										0 1	AF12-30-01-41	1SBL157001R4101	0.270	
48...130	48...130		1 0	AF12-30-10-12				1SBL157001R1210	0.270					
			0 1	AF12-30-01-12				1SBL157001R1201	0.270					
100...250	100...250		1 0	AF12-30-10-13				1SBL157001R1310	0.270					
			0 1	AF12-30-01-13				1SBL157001R1301	0.270					
250...500	250...500		1 0	AF12-30-10-14				1SBL157001R1410	0.310					
			0 1	AF12-30-01-14				1SBL157001R1401	0.310					
7.5	30	10	30	24...60				-	(2)	1 0	AF16-30-10-41	1SBL177001R4110	0.270	
									0 1	AF16-30-01-41	1SBL177001R4101	0.270		
48...130				48...130		1 0	AF16-30-10-12	1SBL177001R1210	0.270					
						0 1	AF16-30-01-12	1SBL177001R1201	0.270					
100...250				100...250		1 0	AF16-30-10-13	1SBL177001R1310	0.270					
						0 1	AF16-30-01-13	1SBL177001R1301	0.270					
250...500				250...500		1 0	AF16-30-10-14	1SBL177001R1410	0.310					
						0 1	AF16-30-01-14	1SBL177001R1401	0.310					
11				45	15	45	24...60	-	(2)	0 0	AF26-30-00-41	1SBL237001R4100	0.310	
									0 0	AF26-30-00-12	1SBL237001R1200	0.310		
100...250	100...250		0 0				AF26-30-00-13	1SBL237001R1300	0.310					
			0 0				AF26-30-00-14	1SBL237001R1400	0.350					
250...500	250...500		0 0				AF26-30-00-14	1SBL237001R1400	0.350					
15	50	20	50	24...60	-	(2)	0 0	AF30-30-00-41	1SBL277001R4100	0.310				
						0 0	AF30-30-00-12	1SBL277001R1200	0.310					
100...250				100...250		0 0	AF30-30-00-13	1SBL277001R1300	0.310					
						0 0	AF30-30-00-14	1SBL277001R1400	0.350					
250...500				250...500		0 0	AF30-30-00-14	1SBL277001R1400	0.350					
18.5	50	25	50	24...60	-	(2)	0 0	AF38-30-00-41	1SBL297001R4100	0.310				
						0 0	AF38-30-00-12	1SBL297001R1200	0.310					
100...250				100...250		0 0	AF38-30-00-13	1SBL297001R1300	0.310					
						0 0	AF38-30-00-14	1SBL297001R1400	0.350					

(1) For other auxiliary contacts arrangements, please contact your ABB local sales organization.

(2) For 24...60 V 50/60 Hz - 20...60 V DC, use AF.Z-30...-21.

#### Main dimensions mm, inches

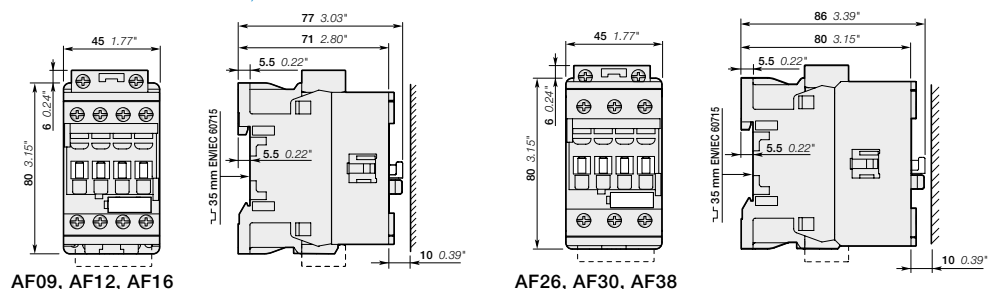

# AF09Z ... AF38Z 3-pole contactors

## 4 to 18.5 kW

### AC / DC operated - low consumption



AF09Z-30-10

1SBC101001V0014



AF26Z-30-00

1SBC101001V0014

#### Description

AF09Z ... AF38Z contactors are mainly used for controlling 3-phase motors and power circuits up to 690 V AC and 220 V DC. These contactors are of the block type design with 3 main poles.

- control circuit: AC or DC operated with electronic coil interface accepting a wide control voltage range (e.g. 100...250 V AC and DC), only 4 control voltage ranges covering 24...250 V 50/60 Hz and 12...250 V DC
- can manage large control voltage variations
- allow direct control by PLC-output  $\geq 24$  V DC 500 mA
- reduced panel energy consumption
- very distinct closing and opening
- can withstand short voltage dips and voltage sags (SEMI F47-0706 conditions of use on request).
- built-in surge suppression
- add-on auxiliary contact blocks for front or side mounting and a wide range of accessories.

#### Ordering details

IEC		UL/CSA		Rated control circuit voltage		Auxiliary contacts fitted		Type (1)	Order code	Weight
Rated power	operational current $\theta \leq 40^\circ\text{C}$	3-phase motor rating	General use rating	Uc min. ... Uc max.						Pkg (1 pce)
400 V AC-3	AC-1	480 V	600 V AC	V 50/60 Hz	V DC					kg
kW	A	hp	A							
4	25	5	25	-	12...20	1	0	AF09Z-30-10-20	1SBL136001R2010	0.310
				24...60	20...60	0	1	AF09Z-30-01-20	1SBL136001R2001	0.310
				48...130	48...130	1	0	AF09Z-30-10-21	1SBL136001R2110	0.310
				100...250	100...250	0	1	AF09Z-30-01-21	1SBL136001R2101	0.310
						1	0	AF09Z-30-10-22	1SBL136001R2210	0.310
						0	1	AF09Z-30-01-22	1SBL136001R2201	0.310
5.5	28	7.5	28	-	12...20	1	0	AF12Z-30-10-20	1SBL156001R2010	0.310
				24...60	20...60	0	1	AF12Z-30-01-20	1SBL156001R2001	0.310
				48...130	48...130	1	0	AF12Z-30-10-21	1SBL156001R2110	0.310
				100...250	100...250	0	1	AF12Z-30-01-21	1SBL156001R2101	0.310
						1	0	AF12Z-30-10-22	1SBL156001R2210	0.310
						0	1	AF12Z-30-01-22	1SBL156001R2201	0.310
7.5	30	10	30	-	12...20	1	0	AF16Z-30-10-20	1SBL176001R2010	0.310
				24...60	20...60	0	1	AF16Z-30-01-20	1SBL176001R2001	0.310
				48...130	48...130	1	0	AF16Z-30-10-21	1SBL176001R2110	0.310
				100...250	100...250	0	1	AF16Z-30-01-21	1SBL176001R2101	0.310
						1	0	AF16Z-30-10-22	1SBL176001R2210	0.310
						0	1	AF16Z-30-01-22	1SBL176001R2201	0.310
11	45	15	45	-	12...20	0	0	AF26Z-30-00-20	1SBL236001R2000	0.350
				24...60	20...60	0	0	AF26Z-30-00-21	1SBL236001R2100	0.350
				48...130	48...130	0	0	AF26Z-30-00-22	1SBL236001R2200	0.350
				100...250	100...250	0	0	AF26Z-30-00-23	1SBL236001R2300	0.350
15	50	20	50	-	12...20	0	0	AF30Z-30-00-20	1SBL276001R2000	0.350
				24...60	20...60	0	0	AF30Z-30-00-21	1SBL276001R2100	0.350
				48...130	48...130	0	0	AF30Z-30-00-22	1SBL276001R2200	0.350
				100...250	100...250	0	0	AF30Z-30-00-23	1SBL276001R2300	0.350
18.5	50	25	50	-	12...20	0	0	AF38Z-30-00-20	1SBL296001R2000	0.350
				24...60	20...60	0	0	AF38Z-30-00-21	1SBL296001R2100	0.350
				48...130	48...130	0	0	AF38Z-30-00-22	1SBL296001R2200	0.350
				100...250	100...250	0	0	AF38Z-30-00-23	1SBL296001R2300	0.350

(1) For other auxiliary contacts arrangements, please contact your ABB local sales organization.

Note: Only AF.Z contactors with DC control voltage 12...20 V DC need to respect the connection polarities indicated close to the coil terminals: A1+ for the positive pole and A2- for the negative pole.

#### Main dimensions mm, inches

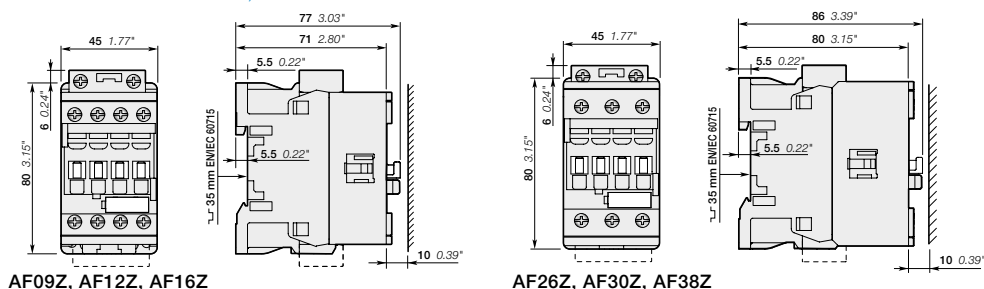

AF09Z, AF12Z, AF16Z

AF26Z, AF30Z, AF38Z

1SBC10137250201 - Rev. B

# AF40 ... AF96 3-pole contactors

## 18.5 to 45 kW

### AC / DC operated



AF40-30-00



AF80-30-00

#### Description

AF40 ... AF96 contactors are mainly used for controlling 3-phase motors and power circuits up to 690 V AC and 220 V DC. These contactors are of the block type design with 3 main poles.

- control circuit: AC or DC operated with electronic coil interface accepting a wide control voltage range (e.g. 100...250 V AC and DC), only 4 control voltage ranges covering 24...500 V 50/60 Hz and 20...500 V DC
- can manage large control voltage variations
- reduced panel energy consumption
- very distinct closing and opening.
- built-in surge suppression
- add-on auxiliary contact blocks for front or side mounting and a wide range of accessories.

#### Ordering details

IEC		UL / CSA		Rated control circuit voltage		Auxiliary contacts fitted	Type (1)	Order code	Weight
Rated operational power	current	3-phase motor rating	General use rating	Uc min. ... Uc max.					
400 V AC-3	AC-1	480 V	600 V AC	V 50/60 Hz	V DC			Pkg (1 pce)	
kW	A	hp	A					kg	
18.5	70	30	60	24...60	-	0 0	AF40-30-00-41	1SBL347001R4100	0.970
				24...60	20...60 (2)	0 0	AF40-30-00-11	1SBL347001R1100	0.970
				48...130	48...130	0 0	AF40-30-00-12	1SBL347001R1200	0.970
				100...250	100...250	0 0	AF40-30-00-13	1SBL347001R1300	0.950
				250...500	250...500	0 0	AF40-30-00-14	1SBL347001R1400	0.950
22	100	40	80	24...60	-	0 0	AF52-30-00-41	1SBL367001R4100	0.970
				24...60	20...60 (2)	0 0	AF52-30-00-11	1SBL367001R1100	0.970
				48...130	48...130	0 0	AF52-30-00-12	1SBL367001R1200	0.970
				100...250	100...250	0 0	AF52-30-00-13	1SBL367001R1300	0.950
				250...500	250...500	0 0	AF52-30-00-14	1SBL367001R1400	0.950
30	105	50	90	24...60	-	0 0	AF65-30-00-41	1SBL387001R4100	0.970
				24...60	20...60 (2)	0 0	AF65-30-00-11	1SBL387001R1100	0.970
				48...130	48...130	0 0	AF65-30-00-12	1SBL387001R1200	0.970
				100...250	100...250	0 0	AF65-30-00-13	1SBL387001R1300	0.950
				250...500	250...500	0 0	AF65-30-00-14	1SBL387001R1400	0.950
37	125	60	105	24...60	-	0 0	AF80-30-00-41	1SBL397001R4100	1.220
				24...60	20...60 (2)	0 0	AF80-30-00-11	1SBL397001R1100	1.220
				48...130	48...130	0 0	AF80-30-00-12	1SBL397001R1200	1.220
				100...250	100...250	0 0	AF80-30-00-13	1SBL397001R1300	1.170
				250...500	250...500	0 0	AF80-30-00-14	1SBL397001R1400	1.170
45	130	60	115	24...60	-	0 0	AF96-30-00-41	1SBL407001R4100	1.220
				24...60	20...60 (2)	0 0	AF96-30-00-11	1SBL407001R1100	1.220
				48...130	48...130	0 0	AF96-30-00-12	1SBL407001R1200	1.220
				100...250	100...250	0 0	AF96-30-00-13	1SBL407001R1300	1.170
				250...500	250...500	0 0	AF96-30-00-14	1SBL407001R1400	1.170

(1) For other auxiliary contacts arrangements, please contact your ABB local sales organization.

(2) AF...-30...-11 not suitable for direct control by PLC-output.

#### Main dimensions mm, inches

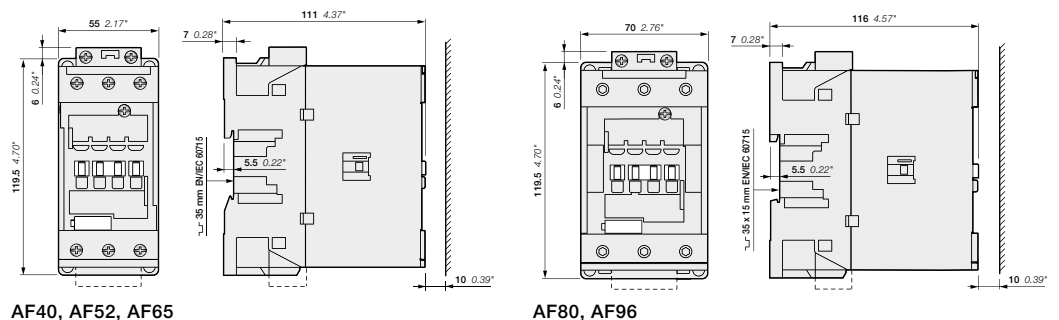

AF40, AF52, AF65

AF80, AF96

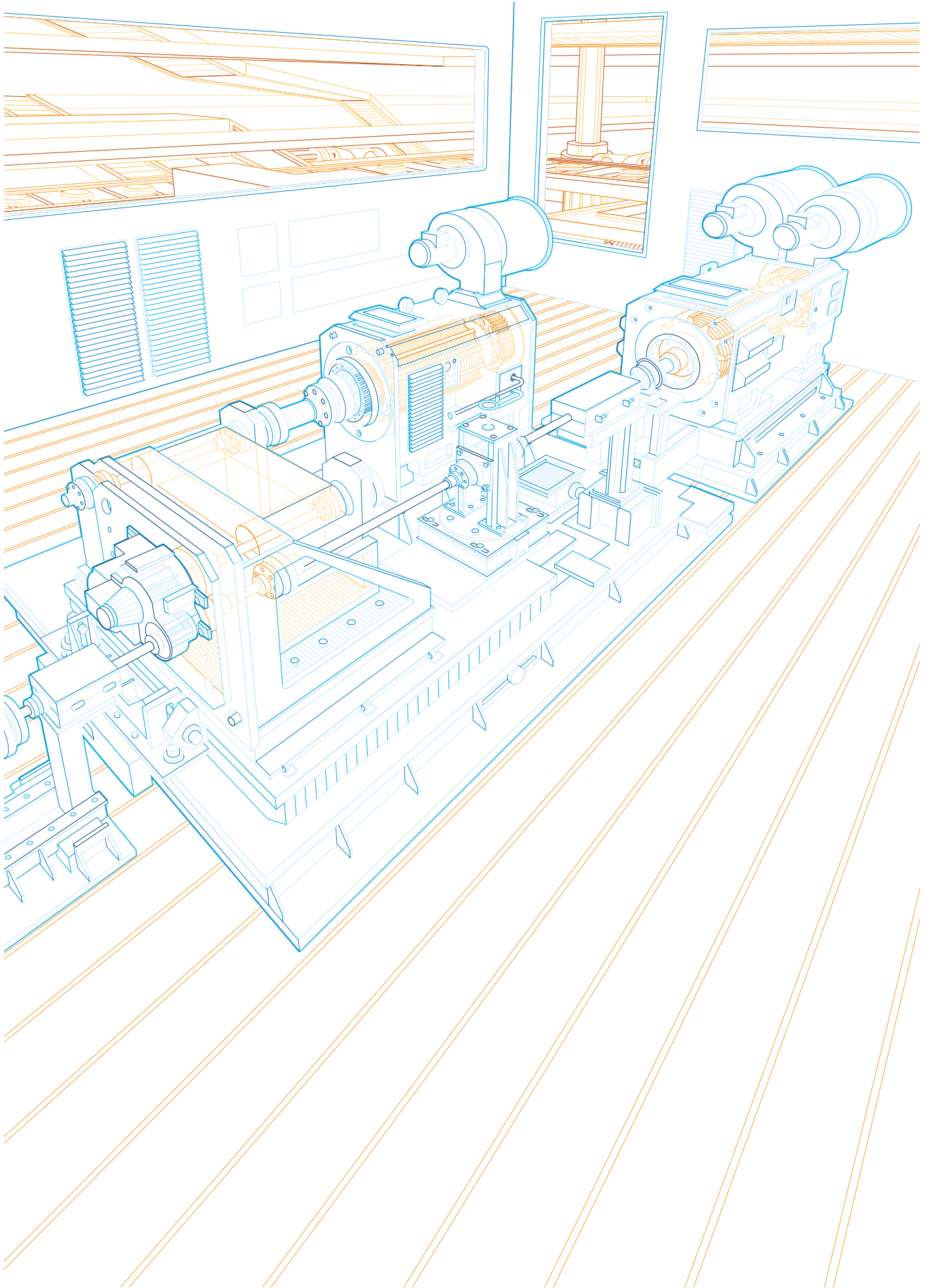

# AF09 ... AF96 3-pole contactors

## Main accessories

### Contactor and main accessories (other accessories available)

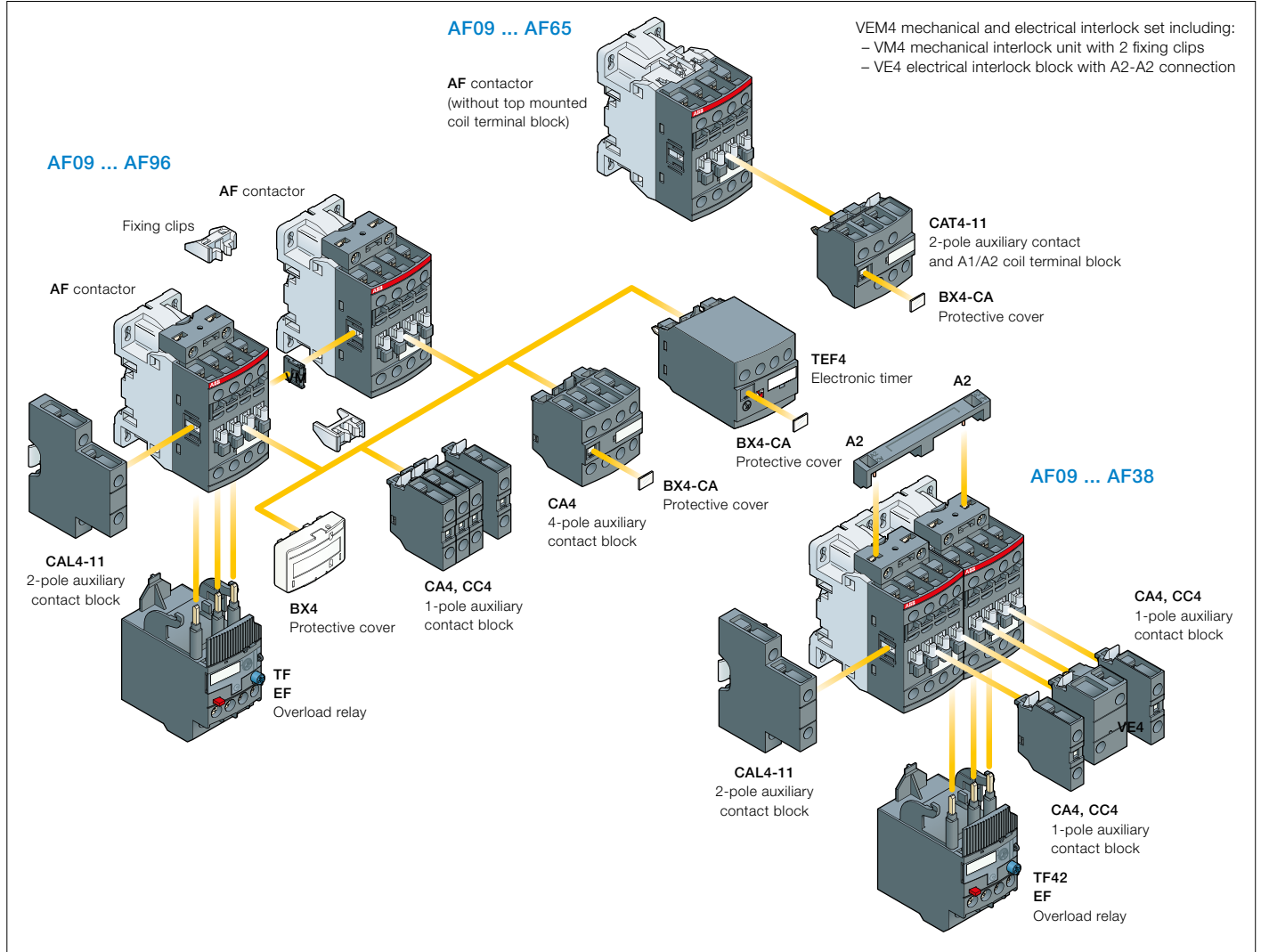

### Main accessory fitting details

Many configurations of accessories are possible depending on whether these are front-mounted or side-mounted.

Contactor types	Main poles	Built-in auxiliary contacts	Front-mounted accessories					Electrical and mechanical interlock set (between 2 contactors)		Side-mounted accessories	
			Auxiliary contact blocks			Electronic timer	Auxiliary contact blocks		Left side	Right side	
			1-pole CA4	1-pole CC4	2-pole CAT4-11	4-pole CA4	TEF4	VEM4	2-pole CAL4-11		
Max. N.C. built-in and add-on N.C. auxiliary contacts: 4 N.C. max. on positions 1, 2, 3, 4 and 3 N.C. max. on positions 1 ±30°, 5											
AF09 ... AF16	3	0	0	1	4 max. or 1	or 1	or 1	-	+ 1	-	-
AF09 ... AF16	3	0	1	0	2 max. or 1	-	or 1	-	+ 1	+ 1	-
AF26 ... AF38	3	0	0	0	3 max.	-	-	+ 1	+ 1	or 1	-
Max. add-on N.C. auxiliary contacts: 6 N.C. max. on positions 1, 1 ±30°, 2, 3, 4, 5											
AF40 ... AF65	3	0	0	0	4 max. or 1	or 1	or 1	-	+ 1	+ 1	-
AF80, AF96	3	0	0	0	4 max.	-	or 1	-	+ 1	+ 1	-

### Overload relays fitting details (1)

Contactor types	Thermal overload relays	Electronic overload relays
AF09 ... AF38	TF42 (0.10...38 A)	EF19 (0.10...19 A)
AF26 ... AF38	TF42 (0.10...38 A)	EF45 (9...45 A)
AF40 ... AF65	TF65 (22...67 A)	EF65 (20...70 A)
AF80, AF96	TF96 (40...96 A)	EF96 (36...100 A)

The addition of an overload relay on the contactor does not prevent fitting of many other accessories as shown above.

(1) Direct mounting - No kit required.

# AF09 ... AF96 3-pole contactors

## Main accessories



CA4-10



CAL4-11



CA4-22E



CAT4-11E

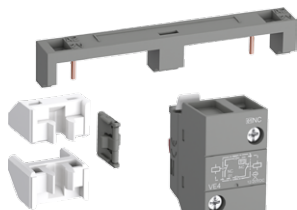

VEM4

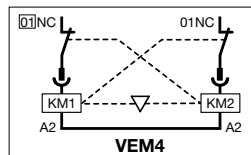

TEF4-ON

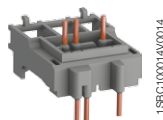

BEA16-4

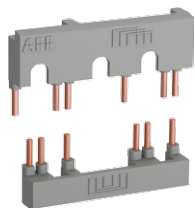

BER16-4

### Ordering details (1)

For contactors	Auxiliary contacts	Type	Order code	Pkg qty	Weight (1 pce)
					kg

#### Front-mounted instantaneous auxiliary contact blocks

AF09 ... AF96	1 0	--	CA4-10	1SBN010110R1010	1	0.014
	1 0	--	CA4-10-T	1SBN010110T1010	10	0.014
	0 1	--	CA4-01	1SBN010110R1001	1	0.014
	0 1	--	CA4-01-T	1SBN010110T1001	10	0.014
AF09 ... AF16...-30-10	2 2	--	CA4-22M	1SBN010140R1122	1	0.055
AF26 ... AF96...-30-00	2 2	--	CA4-22E	1SBN010140R1022	1	0.055
AF09 ... AF16...-30-01	2 2	--	CA4-22U	1SBN010140R1322	1	0.055

#### Front-mounted auxiliary contact blocks with N.O. leading contact and N.C. lagging contact

AF09 ... AF96	--	1 0	CC4-10	1SBN010111R1010	1	0.014
	--	0 1	CC4-01	1SBN010111R1001	1	0.014

#### Side-mounted instantaneous auxiliary contact blocks

AF09 ... AF96	1 1	--	CAL4-11	1SBN010120R1011	1	0.040
	1 1	--	CAL4-11-T	1SBN010120T1011	10	0.040

#### Front-mounted instantaneous auxiliary contact and A1/A2 coil terminal blocks

AF09 ... AF16...-30-10	1 1	--	CAT4-11M	1SBN010151R1111	1	0.040
AF26 ... AF65...-30-00	1 1	--	CAT4-11E	1SBN010151R1011	1	0.040
AF09 ... AF16...-30-01	1 1	--	CAT4-11U	1SBN010151R1311	1	0.040

Note: CAT4 not suitable for AF...Z contactors with DC control voltage 12...20 V DC.

#### Mechanical interlock unit

AF09 ... AF38			VM4	1SBN030105T1000	10	0.005
AF40 ... AF96			VM96-4	1SBN033405T1000	10	0.006

Note: VM4 and VM96-4 include 2 fixing clips (BB4) to maintain together both contactors.

#### Mechanical and electrical interlock set

AF09 ... AF16	0 2	--	VEM4	1SBN030111R1000	1	0.035
AF26 ... AF38						

Note: - VEM4 includes a VM4 mechanical interlock unit with 2 fixing clips (BB4), a VE4 electrical interlock block. VE4 block must be used with A2-A2 connection to respect the electrical connection diagram.  
- VEM4 not suitable for AF...Z contactors with DC control voltage 12...20 V DC.

For contactors	Time delay range	Delay type	Auxiliary contacts	Type	Order code	Pkg qty	Weight (1 pce)
	selected by switch						kg

#### Electronic timers

AF09 ... AF96	0.1...1 s	ON-delay	1 1	TEF4-ON	1SBN020112R1000	1	0.065
	1...10 s						
	10...100 s	OFF-delay	1 1	TEF4-OFF	1SBN020114R1000	1	0.065

Note: Rated control circuit voltage U<sub>c</sub> 24...240 V 50/60 Hz or DC.

#### Connecting links with manual motor starters

AF09 ... AF16	with	MS116-0.16 ... MS116-25, MS132-0.16 ... MS132-25		BEA16-4	1SBN081306T1000	10	0.025
AF26 ... AF38	with	MS116-0.16 ... MS116-16, MS132-0.16 ... MS132-10		BEA26-4	1SBN082306T1000	10	0.025
	with	MS116-20 ... MS116-32, MS132-12 ... MS132-32		BEA38-4	1SBN082306T2000	10	0.030

#### Connection sets for reversing contactors

AF09 ... AF16				BER16-4	1SBN081311R1000	1	0.045
AF26 ... AF38				BER38-4	1SBN082311R1000	1	0.100
AF40 ... AF65				BER65-4	1SBN083411R1000	1	0.175
AF80 ... AF96				BER96-4	1SBN083911R1000	1	0.250

#### Connection sets for star-delta starting

AF09 ... AF16	With or without VM4			BEY16-4	1SBN081313R2000	1	0.050
AF26 ... AF38	With or without VM4			BEY38-4	1SBN082713R2000	1	0.110
AF40 ... AF65	With or without VM96-4			BEY65-4	1SBN083413R2000	1	0.200
AF80 ... AF96	With or without VM96-4			BEY96-4	1SBN083913R2000	1	0.250

(1) For more information, refer to main catalog "Accessories" section.

# AF116 ... AF146 3-pole contactors

## 55 to 75 kW

### AC / DC operated with 1 N.O. + 1 N.C. auxiliary contacts



AF146-30-11



AF146-30-11B

#### Description

AF116 ... AF146 contactors are mainly used for controlling 3-phase motors and power circuits up to 690 V AC, AF146 up to 1000 V AC. These contactors are of the block type design with 3 main poles.

- control circuit: AC or DC operated with electronic coil interface accepting a wide control voltage range (e.g. 100...250 V AC and DC), only 4 coils to cover control voltages between 24...500 V 50/60 Hz and 20...500 V DC
- can manage large control voltage variations
- reduced panel energy consumption
- very distinct closing and opening
- can withstand short voltage dips and voltage sags (SEMI F47 conditions of use on request).
- built-in surge suppression
- add-on auxiliary contact blocks for side mounting and a wide range of accessories.

#### Ordering details

IEC		UL / CSA		Rated control circuit voltage		Auxiliary contacts fitted	Type (1)	Order code	Weight Pkg (1 pce)
Rated operational power	current $\theta \leq 40^\circ\text{C}$	3-phase motor rating	General use rating	Uc min. ... Uc max.	Uc max.				
400 V AC-3	AC-1	480 V	600 V AC	V 50/60 Hz; V DC					kg
kW	A	hp	A						

#### For connection with built-in cable clamps

Rated operational power (kW)	Rated current (A)	3-phase motor rating (hp)	General use rating (A)	Uc min. (V)	Uc max. (V)	Number of contacts	Type	Order code	Weight (kg)
55	160	75	160	24...60	20...60	1 1	AF116-30-11-11	1SFL427001R1111	1.750
				48...130	48...130	1 1	AF116-30-11-12	1SFL427001R1211	1.750
				100...250	100...250	1 1	AF116-30-11-13	1SFL427001R1311	1.750
				250...500	250...500	1 1	AF116-30-11-14	1SFL427001R1411	1.750
75	200	100	200	24...60	20...60	1 1	AF140-30-11-11	1SFL447001R1111	1.750
				48...130	48...130	1 1	AF140-30-11-12	1SFL447001R1211	1.750
				100...250	100...250	1 1	AF140-30-11-13	1SFL447001R1311	1.750
				250...500	250...500	1 1	AF140-30-11-14	1SFL447001R1411	1.750
75	225	100	200	24...60	20...60	1 1	AF146-30-11-11	1SFL467001R1111	1.750
				48...130	48...130	1 1	AF146-30-11-12	1SFL467001R1211	1.750
				100...250	100...250	1 1	AF146-30-11-13	1SFL467001R1311	1.750
				250...500	250...500	1 1	AF146-30-11-14	1SFL467001R1411	1.750

#### With bar connections

Rated operational power (kW)	Rated current (A)	3-phase motor rating (hp)	General use rating (A)	Uc min. (V)	Uc max. (V)	Number of contacts	Type	Order code	Weight (kg)
55	160	75	160	24...60	20...60	1 1	AF116-30-11B-11	1SFL427002R1111	1.500
				48...130	48...130	1 1	AF116-30-11B-12	1SFL427002R1211	1.500
				100...250	100...250	1 1	AF116-30-11B-13	1SFL427002R1311	1.500
				250...500	250...500	1 1	AF116-30-11B-14	1SFL427002R1411	1.500
75	200	100	200	24...60	20...60	1 1	AF140-30-11B-11	1SFL447002R1111	1.500
				48...130	48...130	1 1	AF140-30-11B-12	1SFL447002R1211	1.500
				100...250	100...250	1 1	AF140-30-11B-13	1SFL447002R1311	1.500
				250...500	250...500	1 1	AF140-30-11B-14	1SFL447002R1411	1.500
75	225	100	200	24...60	20...60	1 1	AF146-30-11B-11	1SFL467002R1111	1.500
				48...130	48...130	1 1	AF146-30-11B-12	1SFL467002R1211	1.500
				100...250	100...250	1 1	AF146-30-11B-13	1SFL467002R1311	1.500
				250...500	250...500	1 1	AF146-30-11B-14	1SFL467002R1411	1.500

(1) For other auxiliary contacts arrangements, please contact your ABB local sales organization.

#### Main dimensions mm, inches

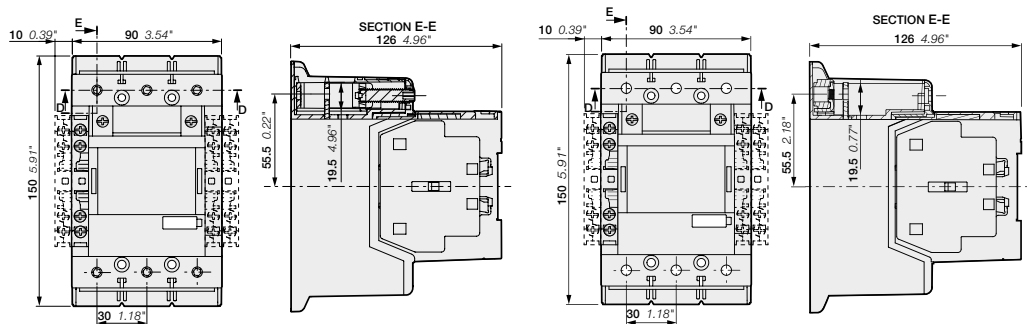

AF116, AF140, AF146-30-11

AF116, AF140, AF146-30-11B



# AF116 ... AF146 3-pole contactors with built-in PLC interface

## 55 to 75 kW

### AC / DC operated with 1 N.O. + 1 N.C. auxiliary contacts



AF146-30-11

1SFC101083V0001



AF146-30-11B

1SFC101188V0001

#### Description

AF116 ... AF140 contactors are mainly used for controlling 3-phase motors and power circuits up to 690 V AC, AF146 up to 1000 V AC. These contactors are of the block type design with 3 main poles.

- control circuit: AC or DC operated with electronic coil interface accepting a wide control voltage range (e.g. 100...250 V AC and DC), only 2 coils to cover control voltages between 100...500 V 50/60 Hz and 100...500 V DC
- can manage large control voltage variations
- reduced panel energy consumption
- very distinct closing and opening
- can withstand short voltage dips and voltage sags (SEMI F47 conditions of use on request).
- built-in surge suppression
- add-on auxiliary contact blocks for side mounting and a wide range of accessories.

#### Ordering details

IEC		UL / CSA		Rated control circuit voltage		Auxiliary contacts fitted	Type (1)	Order code	Weight
Rated operational power	current $\theta \leq 40^\circ\text{C}$	3-phase motor rating	General use rating	Uc min. ...	Uc max.				Pkg (1 pce)
400 V AC-3	AC-1	480 V	600 V AC	V 50/60 Hz	V DC				kg

#### For connection with built-in cable clamps

55	160	75	160	100...250	100...250	1	1	AF116-30-11-33	1SFL427001R3311	1.750
				250...500	250...500	1	1	AF116-30-11-34	1SFL427001R3411	1.750
75	200	100	200	100...250	100...250	1	1	AF140-30-11-33	1SFL447001R3311	1.750
				250...500	250...500	1	1	AF140-30-11-34	1SFL447001R3411	1.750
75	225	100	200	100...250	100...250	1	1	AF146-30-11-33	1SFL467001R3311	1.750
				250...500	250...500	1	1	AF146-30-11-34	1SFL467001R3411	1.750

#### With bar connections

55	160	75	160	100...250	100...250	1	1	AF116-30-11B-33	1SFL427002R3311	1.500
				250...500	250...500	1	1	AF116-30-11B-34	1SFL427002R3411	1.500
75	200	100	200	100...250	100...250	1	1	AF140-30-11B-33	1SFL447002R3311	1.500
				250...500	250...500	1	1	AF140-30-11B-34	1SFL447002R3411	1.500
75	225	100	200	100...250	100...250	1	1	AF146-30-11B-33	1SFL467002R3311	1.500
				250...500	250...500	1	1	AF146-30-11B-34	1SFL467002R3411	1.500

(1) For other auxiliary contacts arrangements, please contact your ABB local sales organization.

AF116 ... AF146 are equipped with low voltage inputs for control, for example by a PLC.

#### Control inputs

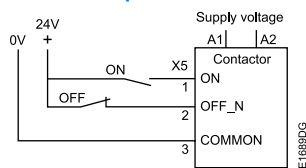

#### Main dimensions mm, inches

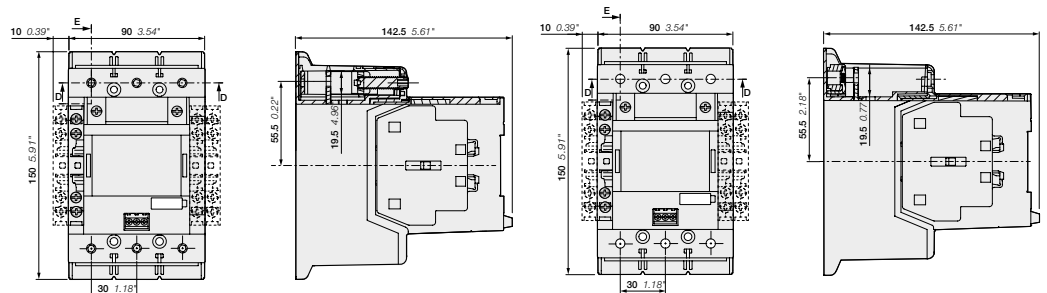

AF116, AF140, AF146-30-11

AF116, AF140, AF146-30-11B

1SFC101168C0201

# AF190 ... AF370 3-pole contactors

## 90 to 200 kW

### AC / DC operated with 1 N.O. + 1 N.C. auxiliary contacts



AF205-30-11

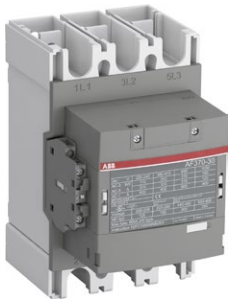

AF370-30-11

#### Description

AF190 ... AF370 contactors are mainly used for controlling 3-phase motors and power circuits up to 1000 V AC. These contactors are of the block type design with 3 main poles.

- control circuit: AC or DC operated with electronic coil interface accepting a wide control voltage range (e.g. 100...250 V AC and DC), only 4 coils to cover control voltages between 24...500 V 50/60 Hz and 20...500 V DC
  - can manage large control voltage variations
  - reduced panel energy consumption
  - very distinct closing and opening
  - can withstand short voltage dips and voltage sags (SEMI F47 conditions of use on request).
- built-in surge suppression
- add-on auxiliary contact blocks for side mounting and a wide range of accessories.

#### Ordering details

IEC	UL / CSA	Rated control circuit voltage	Auxiliary contacts fitted	Type (1)	Order code	Weight			
Rated operational power	3-phase motor rating	Uc min. ... Uc max.				Pkg (1 pce)			
400 V AC-3	480 V	V 50/60 Hz: V DC				kg			
kW	hp	A	A						
90	125	275	250	24...60	20...60	1 1	AF190-30-11-11	1SFL487002R1111	3,000
				48...130	48...130	1 1	AF190-30-11-12	1SFL487002R1211	3,000
				100...250	100...250	1 1	AF190-30-11-13	1SFL487002R1311	3,000
				250...500	250...500	1 1	AF190-30-11-14	1SFL487002R1411	3,000
110	150	350	300	24...60	20...60	1 1	AF205-30-11-11	1SFL527002R1111	3,000
				48...130	48...130	1 1	AF205-30-11-12	1SFL527002R1211	3,000
				100...250	100...250	1 1	AF205-30-11-13	1SFL527002R1311	3,000
				250...500	250...500	1 1	AF205-30-11-14	1SFL527002R1411	3,000
140	200	400	350	24...60	20...60	1 1	AF265-30-11-11	1SFL547002R1111	4,640
				48...130	48...130	1 1	AF265-30-11-12	1SFL547002R1211	4,640
				100...250	100...250	1 1	AF265-30-11-13	1SFL547002R1311	4,640
				250...500	250...500	1 1	AF265-30-11-14	1SFL547002R1411	4,640
160	250	500	400	24...60	20...60	1 1	AF305-30-11-11	1SFL587002R1111	4,640
				48...130	48...130	1 1	AF305-30-11-12	1SFL587002R1211	4,640
				100...250	100...250	1 1	AF305-30-11-13	1SFL587002R1311	4,640
				250...500	250...500	1 1	AF305-30-11-14	1SFL587002R1411	4,640
200	300	600	520	24...60	20...60	1 1	AF370-30-11-11	1SFL607002R1111	4,640
				48...130	48...130	1 1	AF370-30-11-12	1SFL607002R1211	4,640
				100...250	100...250	1 1	AF370-30-11-13	1SFL607002R1311	4,640
				250...500	250...500	1 1	AF370-30-11-14	1SFL607002R1411	4,640

(1) For other auxiliary contacts arrangements, please contact your ABB local sales organization.

#### Main dimensions mm, inches

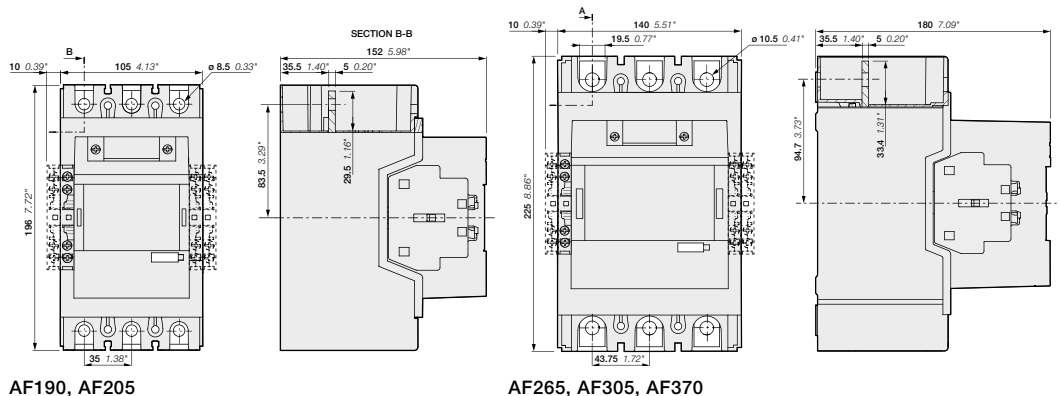

AF190, AF205

AF265, AF305, AF370

1SFC101091C0201 - Rev. D

# AF190 ... AF370 3-pole contactors with built-in PLC interface

## 90 to 200 kW

### AC / DC operated with 1 N.O. + 1 N.C. auxiliary contacts



1SFC101165W0001

AF205-30-11

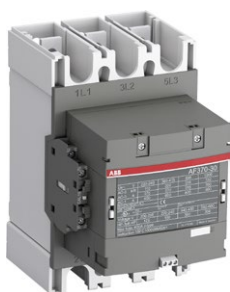

1SFC101153W0001

AF370-30-11

#### Description

AF190 ... AF370 contactors are mainly used for controlling 3-phase motors and power circuits up to 1000 V AC. These contactors are of the block type design with 3 main poles.

- control circuit: AC or DC operated with electronic coil interface accepting a wide control voltage range (e.g. 100...250 V AC and DC), only 2 coils to cover control voltages between 100...500 V 50/60 Hz and 100...500 V DC
- can manage large control voltage variations
- reduced panel energy consumption
- very distinct closing and opening
- can withstand short voltage dips and voltage sags (SEMI F47 conditions of use on request).
- built-in surge suppression
- add-on auxiliary contact blocks for side mounting and a wide range of accessories.

#### Ordering details

IEC		UL / CSA		Rated control circuit voltage		Auxiliary contacts fitted		Type (1)	Order code	Weight
Rated operational power	current $\theta \leq 40^\circ\text{C}$	3-phase motor rating	General use rating	Uc min. ... Uc max.						Pkg (1 pce)
400 V AC-3	AC-1		600 V AC	V 50/60 Hz	V DC					kg
90	275	125	250	100...250	100...250	1	1	AF190-30-11-33	1SFL487002R3311	3.000
				250...500	250...500	1	1	AF190-30-11-34	1SFL487002R3411	3.000
110	350	150	300	100...250	100...250	1	1	AF205-30-11-33	1SFL527002R3311	3.000
				250...500	250...500	1	1	AF205-30-11-34	1SFL527002R3411	3.000
140	400	200	350	100...250	100...250	1	1	AF265-30-11-33	1SFL547002R3311	4.640
				250...500	250...500	1	1	AF265-30-11-34	1SFL547002R3411	4.640
160	500	250	400	100...250	100...250	1	1	AF305-30-11-33	1SFL587002R3311	4.640
				250...500	250...500	1	1	AF305-30-11-34	1SFL587002R3411	4.640
200	600	300	520	100...250	100...250	1	1	AF370-30-11-33	1SFL607002R3311	4.640
				250...500	250...500	1	1	AF370-30-11-34	1SFL607002R3411	4.640

(1) For other auxiliary contacts arrangements, please contact your ABB local sales organization.

AF190 ... AF370 are equipped with low voltage inputs for control, for example by a PLC.

#### Control inputs

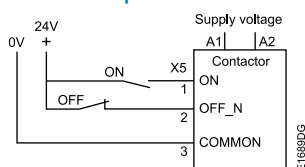

#### Main dimensions mm, inches

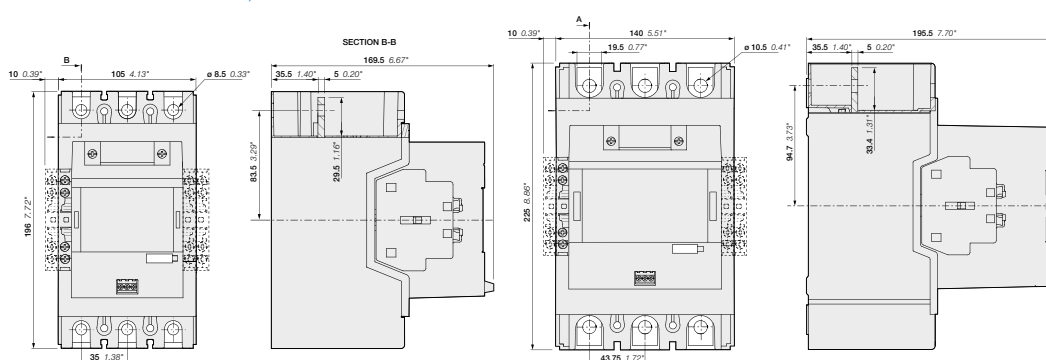

AF190, AF205

AF265, AF305, AF370

1SFC101167C0201

# AF116 ... AF370 3-pole contactors with 1 N.O. + 1 N.C. auxiliary contacts Main accessories

Main accessories (other accessories available)

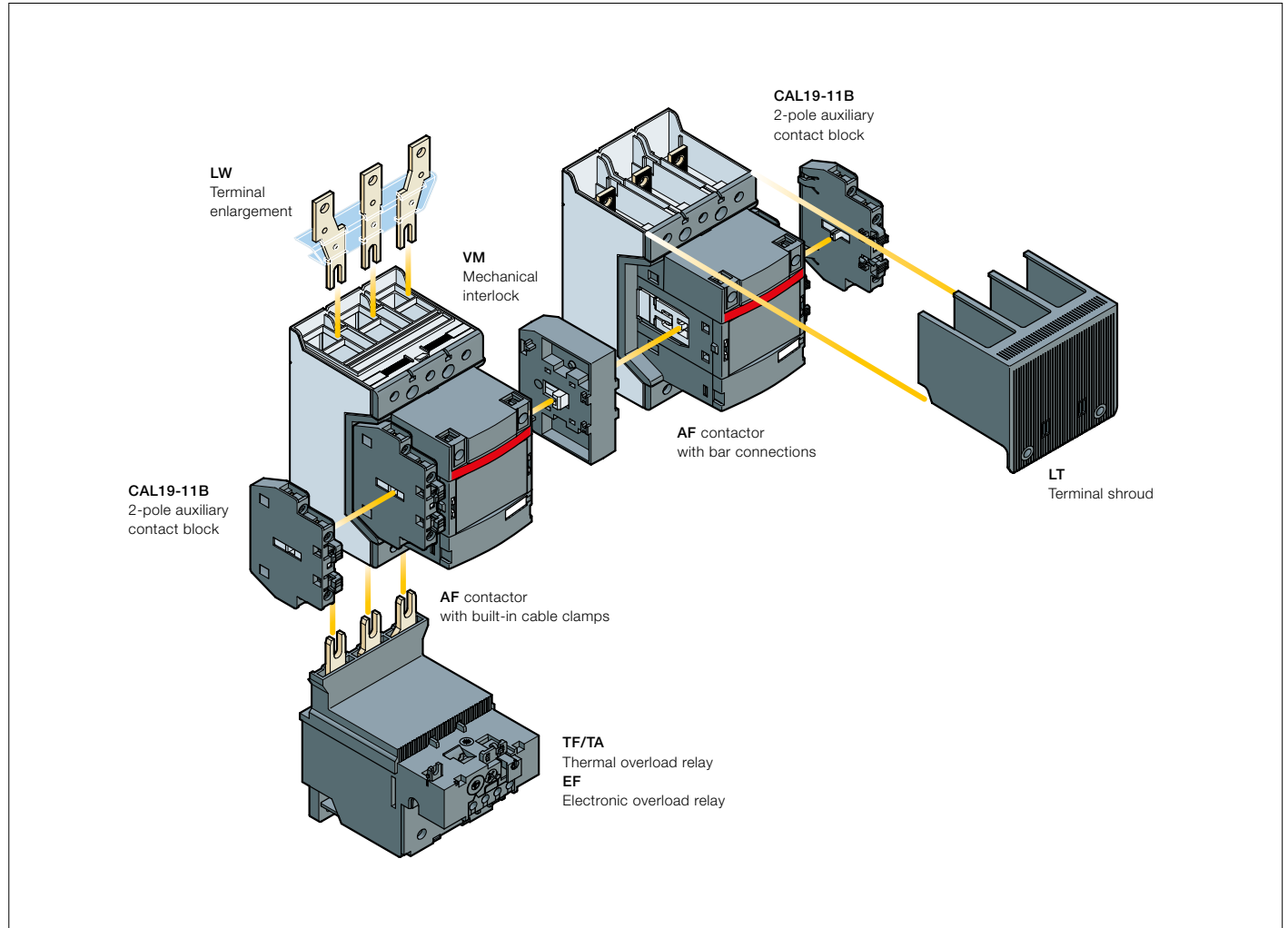

## Main accessory fitting details

Contactor types	Main poles	Available auxiliary contacts	Side-mounted accessories		
			Auxiliary contact blocks		Mechanical interlock units (between two contactors)
			CAL19-11	CAL19-11B	
AF116 ... AF370	3	0 1 1	1 x CAL19-11	+ 2 x CAL19-11B	-
AF116 ... AF370	3	0 1 1	-	+ 2 x CAL19-11B (1)	+ VM... (2)

(1) Total number of auxiliary contact blocks for the two contactors.

(2) Interlock type, according to the contactor ratings (see "Accessories").

## Overload relays fitting details (1)

Contactor types	Thermal overload relays	Electronic overload relays
	AF116 ... AF140	TF140DU (66...142 A)
AF146	-	EF146 (54...150 A)
AF190, AF205	TA200DU (66...200 A)	EF205 (63...210 A)
AF265 ... AF370	-	EF370 (115...380 A)

The addition of a thermal or electronic overload relay on the contactor does not prevent fitting of many other accessories as shown in "Main accessory fitting details" table.

(1) Direct mounting - No kit required.

# AF116 ... AF370 3-pole contactors with 1 N.O. + 1 N.C. auxiliary contacts Main accessories



1SFC101071V0001

CAL19-11

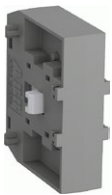

1SFC101035V0001

VM19



1SFC101041V0001

LT370-30C



1SFC101049V0001

LX140

## Ordering details (1)

For contactors	Auxiliary contacts	Type	Order code	Pkg qty	Weight (1 pce)
					kg

## Side-mounted instantaneous auxiliary contact blocks

AF116 ... AF370	1	1	CAL19-11	1SFN010820R1011	2	0.050
	1	1	CAL19-11B	1SFN010820R3311	2	0.050

## Mechanical interlock unit

AF116 ... AF370		VM19	1SFN030300R1000	1	0.054
AF116 ... AF146 and AF190, AF205		VM140/190	1SFN034403R1000	1	0.088
AF190, AF205 and AF265 ... AF370		VM205/265	1SFN035203R1000	1	0.090

## Terminal shrouds

AF116 ... AF146, with compression lugs		LT140-30L	1SFN124203R1000	2	0.070
AF190, AF205, with cable clamps		LT205-30C	1SFN124801R1000	2	0.050
AF190, AF205, with compression lugs		LT205-30L	1SFN124803R1000	2	0.220
AF190, AF205, with shorting bar or between contactor and TOL/EOL in DOL-starters		LT205-30Y	1SFN124804R1000	1	0.050
AF265 ... AF370, with cable clamps		LT370-30C	1SFN125401R1000	2	0.035
AF265 ... AF370, with compression lugs		LT370-30L	1SFN125403R1000	2	0.280
AF265 ... AF370, with shorting bar or between contactor and TOL/EOL in DOL-starters		LT370-30Y	1SFN125404R1000	1	0.075
AF265 ... AF370, for use with extending cable clamps, ATK300/2 and OZXB4		LT370-30D	1SFN125406R1000	1	0.150

For contactors	Dimensions		Type	Order code	Pkg qty	Weight (1 pce)
	hole Ø	bar				kg
	mm	mm				

## Terminal enlargements

AF116...AF146	6.5	13 x 3	LW140	1SFN074207R1000	1	0.115
AF190...AF205	10.5	17.5 x 5	LW205	1SFN074807R1000	1	0.260
AF265...AF370	10.5	20 x 5	LW370	1SFN075407R1000	1	0.340

## Terminal extension

AF116...AF146	6.5	13 x 3	LX140	1SFN074210R1000	1	0.072
AF190...AF250	8.5	17.5 x 5	LX205	1SFN074810R1000	1	0.180
AF265...AF370	10.5	20 x 5	LX370	1SFN075410R1000	1	0.234

(1) For more information, refer to main catalog "Accessories" section.

# AF400 ... AF750 3-pole contactors

## 200 to 400 kW

### AC / DC operated with 1 N.O. + 1 N.C. auxiliary contacts



AF460-30-11



AF750-30-11

#### Description

AF400 ... AF750 contactors are mainly used for controlling 3-phase motors and power circuits up to 1000 V AC or 600 V DC (2). These contactors are of the block type design with 3 main poles.

- control circuit: AC or DC operated with electronic coil interface accepting a wide control voltage range (e.g. 100...250 V AC and DC), only 4 coils to cover control voltages between 48...500 V 50/60 Hz and 24...500 V DC
- can manage large control voltage variations
- reduced panel energy consumption
- very distinct closing and opening
- can withstand short voltage dips and voltages sags (SEMI F47 conditions of use on request).
- built-in surge suppression
- add-on auxiliary contact blocks for side mounting and a wide range of accessories.

#### Ordering details

IEC Rated operational power 400 V AC-3 kW	UL/CSA 3-phase current $\theta \leq 40^\circ\text{C}$ 690 V AC-1 A	General use rating 600 V AC hp	General use rating 600 V AC A	Rated control circuit voltage Uc min. ... Uc max.		Auxiliary contacts fitted	Type	Order code	Weight Pkg (1 pce) kg
				V 50/60 Hz	V DC				
200	600	350	550	-	24...60	1 1	AF400-30-11	1SFL577001R6811 (1)	12.000
				48...130	48...130	1 1	AF400-30-11	1SFL577001R6911	12.000
				100...250	100...250	1 1	AF400-30-11	1SFL577001R7011	12.000
				250...500	250...500	1 1	AF400-30-11	1SFL577001R7111	12.000
250	700	400	650	-	24...60	1 1	AF460-30-11	1SFL597001R6811 (1)	12.000
				48...130	48...130	1 1	AF460-30-11	1SFL597001R6911	12.000
				100...250	100...250	1 1	AF460-30-11	1SFL597001R7011	12.000
				250...500	250...500	1 1	AF460-30-11	1SFL597001R7111	12.000
315	800	500	750	-	24...60	1 1	AF580-30-11	1SFL617001R6811 (1)	15.000
				48...130	48...130	1 1	AF580-30-11	1SFL617001R6911	15.000
				100...250	100...250	1 1	AF580-30-11	1SFL617001R7011	15.000
				250...500	250...500	1 1	AF580-30-11	1SFL617001R7111	15.000
400	1050	600	900	-	24...60	1 1	AF750-30-11	1SFL637001R6811 (1)	15.000
				48...130	48...130	1 1	AF750-30-11	1SFL637001R6911	15.000
				100...250	100...250	1 1	AF750-30-11	1SFL637001R7011	15.000
				250...500	250...500	1 1	AF750-30-11	1SFL637001R7111	15.000

(1) The connection polarities indicated close to the coil terminals must be respected: A1 for the positive pole and A2 for the negative pole.  
 (2) Up to 850 V DC for AF580, AF750.

AF400 ... AF750 are equipped with low voltage inputs for control, for example by a PLC.

#### Control inputs

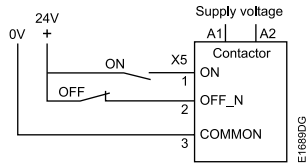

#### Main dimensions mm, inches

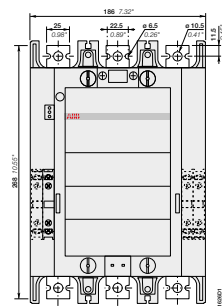

AF400, AF460

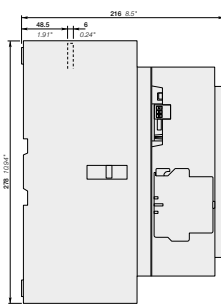

AF580, AF750

# AF1250 ... AF2650 3-pole contactors

## 475 to 560 kW and 1260 to 2650 A AC-1

### AC / DC operated with 1 N.O. + 1 N.C. auxiliary contacts



AF1250-30-11

1SFC101027V0001



AF2650-30-11

1SFC101031V0001

#### Description

AF1250 ... AF2050 contactors are mainly used for controlling power circuits up to 1000 V AC or 850 V DC, AF2650 for controlling power up to 1000 V AC. These contactors are of the block type design with 3 main poles.

- control circuit: AC or DC operated with electronic coil interface accepting a wide control voltage range (e.g. 100...250 V AC and DC)
- only 4 coils for AF1250 to cover control voltages between 48...500 V 50/60 Hz and 24...500 V DC
- only 1 coil for AF1350 ... AF2650 to cover control voltages between 100...250 V 50/60 Hz and 100...250 V DC
- can manage large control voltage variations
- reduced panel energy consumption
- very distinct closing and opening
- can withstand short voltage dips and voltages sags (SEMI F47 conditions of use on request).
- built-in surge suppression
- add-on auxiliary contact blocks for side mounting and a wide range of accessories.

#### Ordering details

IEC		UL/CSA		Rated control circuit voltage U <sub>c</sub>		Auxiliary contacts fitted		Type	Order code	Weight
Rated operational power	Rated current I <sub>n</sub> at θ ≤ 40 °C	3-phase motor rating	General use rating	(1)		1 N.O. + 1 N.C.				Pkg (1 pce)
kW	A	hp	A	V 50/60 Hz	V DC					kg
-	1260	-	1210	-	24...60	1	1	AF1250-30-11	1SFL647001R6811 (1)	16.000
				48...130	48...130	1	1	AF1250-30-11	1SFL647001R6911	16.000
				100...250	100...250	1	1	AF1250-30-11	1SFL647001R7011	16.000
				250...500	250...500	1	1	AF1250-30-11	1SFL647001R7111	16.000
475	1350	800	1350	100...250	100...250	1	1	AF1350-30-11	1SFL657001R7011	34.000
560	1650	900	1650	100...250	100...250	1	1	AF1650-30-11	1SFL677001R7011	35.000
-	2050	-	2100	100...250	100...250	1	1	AF2050-30-11	1SFL707001R7011	35.000
-	2650	-	2700	100...250	100...250	1	1	AF2650-30-11	1SFL667001R7011	45.000

(1) The connection polarities indicated close to the coil terminals must be respected: A1 for the positive pole and A2 for the negative pole.  
 (2) AF2650: Maximum operational voltage = 1000 V according to UL / CSA.

AF1250 ... AF2650 are equipped with low voltage inputs for control, for example by a PLC

#### Control inputs

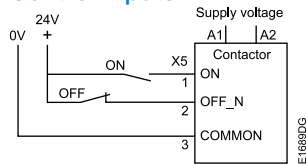

	AF1350, AF1650, AF2050	AF2650
A	392 mm / 15.43"	422 mm / 16.61"
B	47 mm / 1.85"	53 mm / 2.09"
C	10 mm / 0.39"	25 mm / 0.98"

#### Main dimensions mm, inches

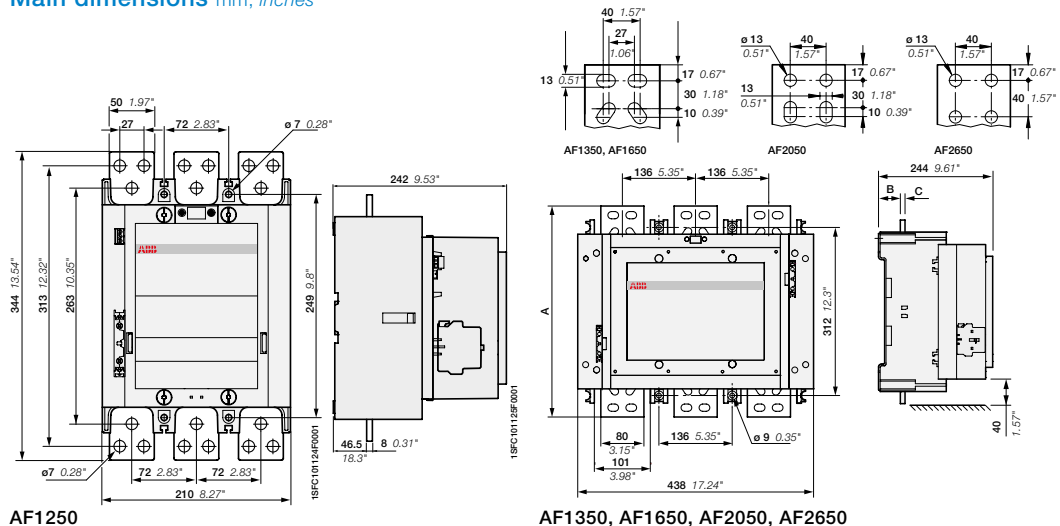

AF1250

AF1350, AF1650, AF2050, AF2650

# AF400 ... AF2650 3-pole contactors with 1 N.O. + 1 N.C. auxiliary contacts Main accessories

Main accessories (other accessories available)

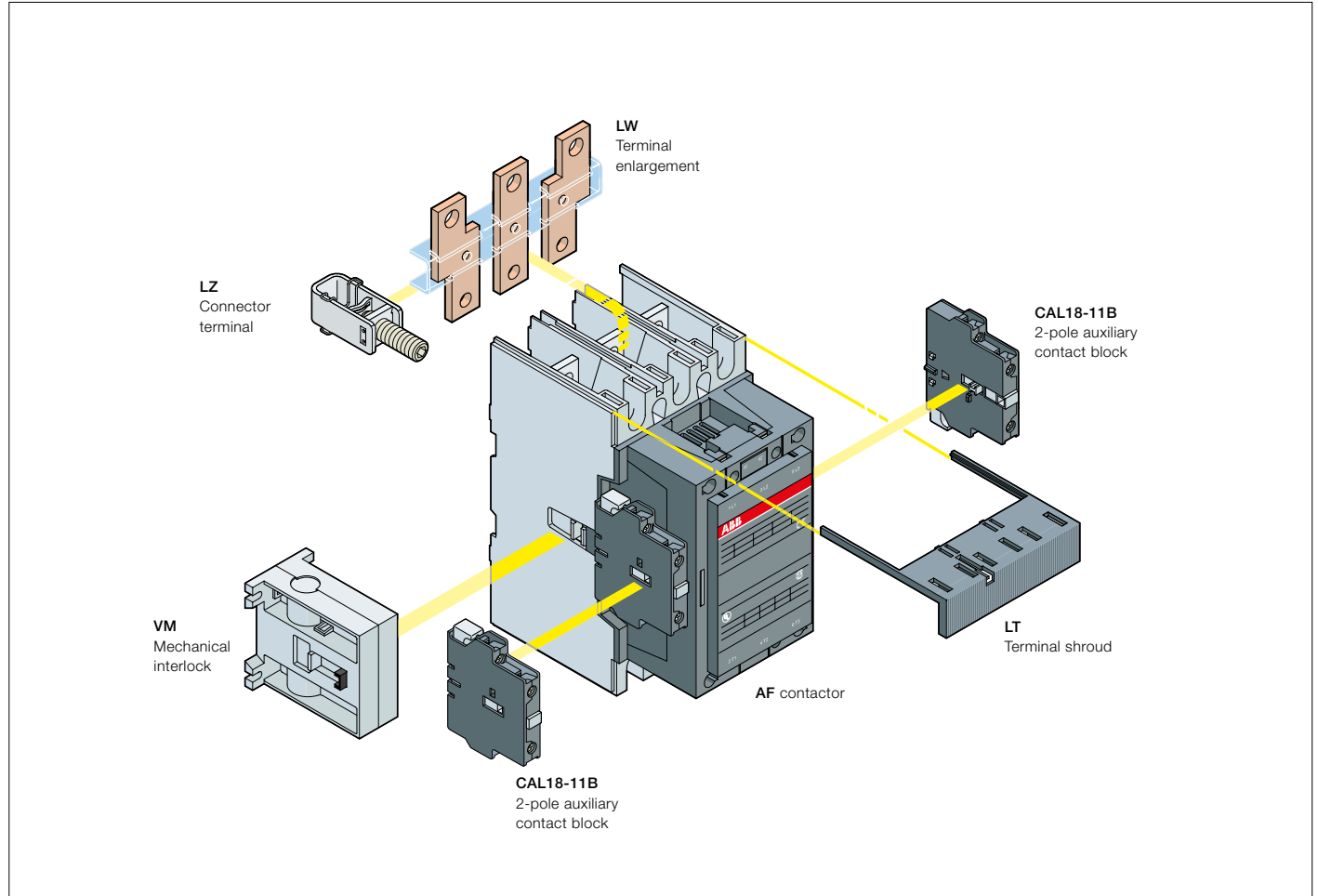

## Main accessory fitting details

Contactor types	Main poles	Available auxiliary contacts	Side-mounted accessories		Mechanical interlock units (between two contactors)
			Auxiliary contact blocks		
			CAL18-11	CAL18-11B (3)	

### Contactors + auxiliary contact blocks

AF400 ... AF2650	3	0	1	1	1 x CAL18-11	+	2 x CAL18-11B	-
------------------	---	---	---	---	--------------	---	---------------	---

### Contactors with mechanical interlocking + auxiliary contact blocks

AF400 ... AF2650	3	0	1	1	2 x CAL18-11 (1)	+	4 x CAL18-11B (1)	+	VM...H (2)
------------------	---	---	---	---	------------------	---	-------------------	---	------------

(1) Total number of auxiliary contact blocks for the two contactors.

(2) Interlock type, according to the contactor ratings (see "Accessories").

(3) The CEL18-.. auxiliary contact blocks can replace the CAL18-11 and CAL18-11B. Though, no auxiliary contact block can be mounted outside the CEL18-..

## Overload relays fitting details

Contactor types	Thermal overload relays	Electronic overload relays
AF400, AF460	-	EF460 (150...500 A) (4)
AF580, AF750	-	EF750 (250...800 A) (4)
AF1350, AF1650	-	E1250DU (375...1250 A) (4)

The addition of a thermal or electronic overload relay on the contactor does not prevent fitting of many other accessories as shown in "Main accessory fitting details" table.

(4) Mounting kit required (see "Motor protection").



# AF400 ... AF2650 3-pole contactors with 1 N.O. + 1 N.C. auxiliary contacts Main accessories



CAL18-11

1SFC101082V0001



VM750H

1SFC101084V0001



LT460-AC

1SFC101089V0001

## Ordering details (1)

For contactors	Auxiliary contacts	Type	Order code	Pkg qty	Weight (1 pce)
					kg

## Side-mounted instantaneous auxiliary contact blocks

AF400 ... AF2650	1	1	CAL18-11	1SFN010720R1011	2	0.050
	1	1	CAL18-11B	1SFN010720R3311	2	0.050

## Mechanical interlock unit

AF400 ... AF1250			VM750H	1SFN035700R1000	1	0.200
AF1350 ... AF2650			VM1650H	1SFN036503R1000	1	6.000

## Terminal shrouds

AF400, AF460 with connectors			LT460-AC	1SFN125701R1000	2	0.100
AF400, AF460 with lugs			LT460-AL	1SFN125703R1000	2	0.800
AF580 ... AF750 with connectors			LT750-AC	1SFN126101R1000	2	0.120
AF580 ... AF750 with lugs			LT750-AL	1SFN126103R1000	2	0.825

For contactors	Dimensions		Type	Order code	Pkg qty	Weight (1 pce)
	hole Ø	bar				kg
	mm	mm				

## Terminal enlargements

AF400, AF460	10.5	25 x 5	LW460	1SFN075707R1000	1	0.730
AF580, AF750	13	40 x 6	LW750	1SFN076107R1000	1	1.230
AF1250	13	50 x 10	LW1250	1SFN076407R1000	1	2.000

## Terminal extension

AF400, AF460	10.5	25 x 5	LX460	1SFN075710R1000	1	0.500
AF580, AF750	13	40 x 6	LX750	1SFN076110R1000	1	0.850

(1) For more information, refer to main catalog "Accessories" section.

# 4-pole contactors



IEC	AC-1 Rated operational current	$\theta \leq 40\text{ }^\circ\text{C}$ , 690 V	A	25	30	45	55	70	100	125
UL/CSA	General use rating	600 V	A	25	30	45	55	60	80	105
AC / DC Control supply			Type	AF09	AF16	AF26	AF38	AF40	AF52	AF80
AC Control supply			Type	AF09	AF16	AF26	AF38	AF40	AF52	AF80
DC Control supply			Type	AF09	AF16	AF26	AF38	AF40	AF52	AF80
IEC	AC-1 Rated operational current	$\theta \leq 40\text{ }^\circ\text{C}$	A	25	30	45	55	70	100	125
	690 V	$\theta \leq 60\text{ }^\circ\text{C}$ (1)	A	25	30	40	45	60	80	105
		$\theta \leq 70\text{ }^\circ\text{C}$	A	22	26	32	37	50	70	90
	With conductor cross sectional area		mm <sup>2</sup>	4	6	10	16	35	35	50
	Rated operational voltage Ue max.		V	690	690	690	690	690	690	690

(1)  $\theta \leq 55\text{ }^\circ\text{C}$  for EK550, EK1000 contactors

## Main accessories

Auxiliary contact blocks	Front mounting	CA4-10 (1 x N.O.), CA4-01 (1 x N.C.)
	Side mounting	CAL4-11 (1 x N.O. + 1 x N.C.)
Timers	Electronic	TEF4-ON
		TEF4-OFF
Interlocking units	Mechanical	VM4
	Mechanical / Electrical	VM96-4
Surge suppressors	Varistor + RC (AC / DC)	Built-in surge protection



160	200	275	350	400	500	525	800	1000
160	175	230	250	300	350	420	540	—
AF116	AF140	AF190	AF205	AF265	AF305	AF370	—	—
AF116	AF140	AF190	AF205	AF265	AF305	AF370	EK550	EK1000
AF116	AF140	AF190	AF205	AF265	AF305	AF370	EK550	EK1000
160	200	275	350	400	500	525	800	1000
145	175	250	300	350	400	425	650	800
130	160	200	240	290	325	350	575	720
70	95	150	240	240	300	2 x 185	2 x 240	2 x 300
690	690	1000	1000	1000	1000	1000	1000	1000

CAL19-11 (1 x N.O. + 1 x N.C.)	CAL16-11 (1 x N.O. + 1 x N.C.)
VM19 (for same size contactors)	VH800
	RC-EH800

# AF09 ... AF38 4-pole contactors

## 25 to 55 A AC-1

### AC / DC operated



AF09-40-00

1SBC101097F0014



AF26-40-00

1SBC101097F0014

#### Description

AF09 ... AF38 4-pole contactors are mainly used for controlling non-inductive or slightly inductive loads (i.e. resistance furnaces...) and generally for controlling power circuits up to 690 V AC and 440 V DC. These contactors are of the block type design with 4 main poles.

- control circuit: AC or DC operated with electronic coil interface accepting a wide control voltage range (e.g. 100...250 V AC and DC), only 4 control voltage ranges covering 24...500 V 50/60 Hz and 20...500 V DC
- can manage large control voltage variations
- reduced panel energy consumption
- very distinct closing and opening.
- built-in surge suppression
- add-on auxiliary contact blocks for front or side mounting and a wide range of accessories.

#### Ordering details

IEC Rated operational current $\theta \leq 40^\circ\text{C}$ AC-1	UL/CSA General use rating 600 V AC	Rated control circuit voltage Uc min. ... Uc max.		Auxiliary contacts fitted	Type	Order code	Weight Pkg (1 pce) kg
		V 50/60 Hz	V DC				
<b>4 N.O. main poles</b>							
25	25	24...60	-	(1) 0 0	AF09-40-00-41	1SBL137201R4100	0.270
		48...130	48...130	0 0	AF09-40-00-12	1SBL137201R1200	0.270
		100...250	100...250	0 0	AF09-40-00-13	1SBL137201R1300	0.270
		250...500	250...500	0 0	AF09-40-00-14	1SBL137201R1400	0.310
30	30	24...60	-	(1) 0 0	AF16-40-00-41	1SBL177201R4100	0.270
		48...130	48...130	0 0	AF16-40-00-12	1SBL177201R1200	0.270
		100...250	100...250	0 0	AF16-40-00-13	1SBL177201R1300	0.270
		250...500	250...500	0 0	AF16-40-00-14	1SBL177201R1400	0.310
45	45	24...60	-	(1) 0 0	AF26-40-00-41	1SBL237201R4100	0.360
		48...130	48...130	0 0	AF26-40-00-12	1SBL237201R1200	0.360
		100...250	100...250	0 0	AF26-40-00-13	1SBL237201R1300	0.360
		250...500	250...500	0 0	AF26-40-00-14	1SBL237201R1400	0.400
55	55	24...60	-	(1) 0 0	AF38-40-00-41	1SBL297201R4100	0.360
		48...130	48...130	0 0	AF38-40-00-12	1SBL297201R1200	0.360
		100...250	100...250	0 0	AF38-40-00-13	1SBL297201R1300	0.360
		250...500	250...500	0 0	AF38-40-00-14	1SBL297201R1400	0.400
<b>2 N.O. + 2 N.C. main poles</b>							
25	25	24...60	-	(1) 0 0	AF09-22-00-41	1SBL137501R4100	0.270
		48...130	48...130	0 0	AF09-22-00-12	1SBL137501R1200	0.270
		100...250	100...250	0 0	AF09-22-00-13	1SBL137501R1300	0.270
		250...500	250...500	0 0	AF09-22-00-14	1SBL137501R1400	0.310
30	30	24...60	-	(1) 0 0	AF16-22-00-41	1SBL177501R4100	0.270
		48...130	48...130	0 0	AF16-22-00-12	1SBL177501R1200	0.270
		100...250	100...250	0 0	AF16-22-00-13	1SBL177501R1300	0.270
		250...500	250...500	0 0	AF16-22-00-14	1SBL177501R1400	0.310
45	45	24...60	-	(1) 0 0	AF26-22-00-41	1SBL237501R4100	0.360
		48...130	48...130	0 0	AF26-22-00-12	1SBL237501R1200	0.360
		100...250	100...250	0 0	AF26-22-00-13	1SBL237501R1300	0.360
		250...500	250...500	0 0	AF26-22-00-14	1SBL237501R1400	0.400
55	55	24...60	-	(1) 0 0	AF38-22-00-41	1SBL297501R4100	0.360
		48...130	48...130	0 0	AF38-22-00-12	1SBL297501R1200	0.360
		100...250	100...250	0 0	AF38-22-00-13	1SBL297501R1300	0.360
		250...500	250...500	0 0	AF38-22-00-14	1SBL297501R1400	0.400

(1) For 24...60 V 50/60 Hz - 20...60 V DC, use AF..Z...00-21.

#### Main dimensions mm, inches

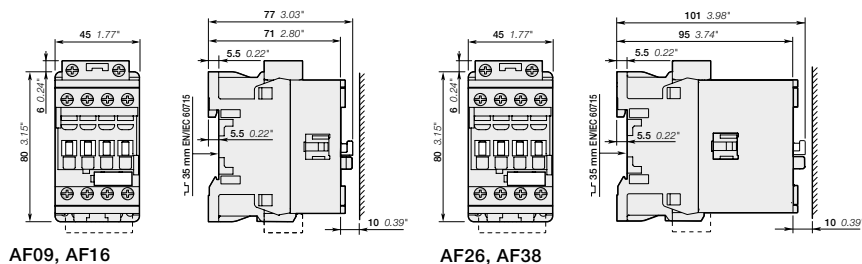

1SBC101375S0201 - Rev. B

# AF09Z ... AF38Z 4-pole contactors

## 25 to 55 A AC-1

### AC / DC operated - low consumption



AF09Z-40-00



AF26Z-40-00

#### Description

AF09Z ... AF38Z 4-pole contactors are mainly used for controlling non-inductive or slightly inductive loads (i.e. resistance furnaces...) and generally for controlling power circuits up to 690 V AC and 440 V DC. These contactors are of the block type design with 4 main poles.

- control circuit: AC or DC operated with electronic coil interface accepting a wide control voltage range (e.g. 100...250 V AC and DC), only 4 control voltage ranges covering 24...250 V 50/60 Hz and 12...250 V DC
- can manage large control voltage variations
- allow direct control by PLC-output  $\geq 24$  V DC 500 mA
- reduced panel energy consumption
- very distinct closing and opening
- can withstand short voltage dips and voltage sags (SEMI F47-0706 conditions of use on request).
- built-in surge suppression
- add-on auxiliary contact blocks for front or side mounting and a wide range of accessories.

#### Ordering details

IEC Rated operational current $\theta \leq 40^\circ\text{C}$ AC-1 A	UL/CSA General use rating 600 V AC A	Rated control circuit voltage Uc min. ... Uc max.		Auxiliary contacts fitted 	Type	Order code	Weight Pkg (1 pce) kg
		V 50/60 Hz	V DC				
<b>4 N.O. main poles</b>							
25	25	-	12...20	0 0	AF09Z-40-00-20	1SBL136201R2000	0.310
		24...60	20...60	0 0	AF09Z-40-00-21	1SBL136201R2100	0.310
		48...130	48...130	0 0	AF09Z-40-00-22	1SBL136201R2200	0.310
		100...250	100...250	0 0	AF09Z-40-00-23	1SBL136201R2300	0.310
30	30	-	12...20	0 0	AF16Z-40-00-20	1SBL176201R2000	0.310
		24...60	20...60	0 0	AF16Z-40-00-21	1SBL176201R2100	0.310
		48...130	48...130	0 0	AF16Z-40-00-22	1SBL176201R2200	0.310
		100...250	100...250	0 0	AF16Z-40-00-23	1SBL176201R2300	0.310
45	45	-	12...20	0 0	AF26Z-40-00-20	1SBL236201R2000	0.400
		24...60	20...60	0 0	AF26Z-40-00-21	1SBL236201R2100	0.400
		48...130	48...130	0 0	AF26Z-40-00-22	1SBL236201R2200	0.400
		100...250	100...250	0 0	AF26Z-40-00-23	1SBL236201R2300	0.400
55	55	-	12...20	0 0	AF38Z-40-00-20	1SBL296201R2000	0.400
		24...60	20...60	0 0	AF38Z-40-00-21	1SBL296201R2100	0.400
		48...130	48...130	0 0	AF38Z-40-00-22	1SBL296201R2200	0.400
		100...250	100...250	0 0	AF38Z-40-00-23	1SBL296201R2300	0.400
<b>2 N.O. + 2 N.C. main poles</b>							
25	25	-	12...20	0 0	AF09Z-22-00-20	1SBL136501R2000	0.310
		24...60	20...60	0 0	AF09Z-22-00-21	1SBL136501R2100	0.310
		48...130	48...130	0 0	AF09Z-22-00-22	1SBL136501R2200	0.310
		100...250	100...250	0 0	AF09Z-22-00-23	1SBL136501R2300	0.310
30	30	-	12...20	0 0	AF16Z-22-00-20	1SBL176501R2000	0.310
		24...60	20...60	0 0	AF16Z-22-00-21	1SBL176501R2100	0.310
		48...130	48...130	0 0	AF16Z-22-00-22	1SBL176501R2200	0.310
		100...250	100...250	0 0	AF16Z-22-00-23	1SBL176501R2300	0.310
45	45	-	12...20	0 0	AF26Z-22-00-20	1SBL236501R2000	0.400
		24...60	20...60	0 0	AF26Z-22-00-21	1SBL236501R2100	0.400
		48...130	48...130	0 0	AF26Z-22-00-22	1SBL236501R2200	0.400
		100...250	100...250	0 0	AF26Z-22-00-23	1SBL236501R2300	0.400
55	55	-	12...20	0 0	AF38Z-22-00-20	1SBL296501R2000	0.400
		24...60	20...60	0 0	AF38Z-22-00-21	1SBL296501R2100	0.400
		48...130	48...130	0 0	AF38Z-22-00-22	1SBL296501R2200	0.400
		100...250	100...250	0 0	AF38Z-22-00-23	1SBL296501R2300	0.400

Note: Only AF.Z contactors with DC control voltage 12...20 V DC need to respect the connection polarities indicated close to the coil terminals: A1+ for the positive pole and A2- for the negative pole.

#### Main dimensions mm, inches

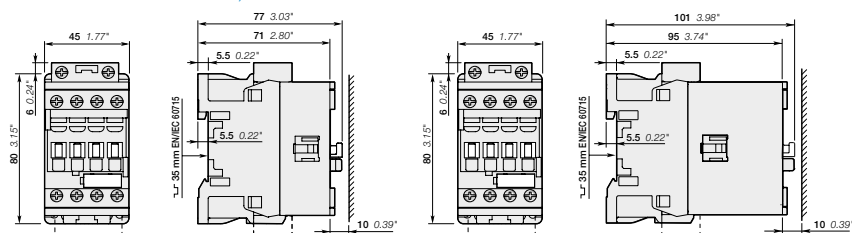

AF09Z, AF16Z

AF26Z, AF38Z

# AF40 ... AF80 4-pole contactors

## 70 to 125 A AC-1

### AC / DC operated



AF40-40-00



AF80-40-00

#### Description

AF40 ... AF80 4-pole contactors are mainly used for controlling non-inductive or slightly inductive loads (i.e. resistance furnaces...) and generally for controlling power circuits up to 690 V AC and 440 V DC. These contactors are of the block type design with 4 main poles.

- control circuit: AC or DC operated with electronic coil interface accepting a wide control voltage range (e.g. 100...250 V AC and DC), only 4 control voltages ranges covering 24...500 V 50/60 Hz and 20...500 V DC
- can manage large control voltage variations
- reduced panel energy consumption
- very distinct closing and opening.
- built-in surge suppression
- add-on auxiliary contact blocks for front or side mounting and a wide range of accessories.

#### Ordering details

IEC Rated operational current $\theta \leq 40^\circ\text{C}$ AC-1	UL/CSA General use rating 600 V AC	Rated control circuit voltage Uc min. ... Uc max.		Auxiliary contacts fitted	Type (1)	Order code	Weight Pkg (1 pce) kg
		V 50/60 Hz	V DC				
<b>4 N.O. Main Poles</b>							
70	60	24...60	-	0 0	AF40-40-00-41	1SBL347201R4100	1.210
		24...60	20...60 (1)	0 0	AF40-40-00-11	1SBL347201R1100	1.210
		48...130	48...130	0 0	AF40-40-00-12	1SBL347201R1200	1.210
		100...250	100...250	0 0	AF40-40-00-13	1SBL347201R1300	1.160
		250...500	250...500	0 0	AF40-40-00-14	1SBL347201R1400	1.160
100	80	24...60	-	0 0	AF52-40-00-41	1SBL367201R4100	1.210
		24...60	20...60 (1)	0 0	AF52-40-00-11	1SBL367201R1100	1.210
		48...130	48...130	0 0	AF52-40-00-12	1SBL367201R1200	1.210
		100...250	100...250	0 0	AF52-40-00-13	1SBL367201R1300	1.160
		250...500	250...500	0 0	AF52-40-00-14	1SBL367201R1400	1.160
125	105	24...60	-	0 0	AF80-40-00-41	1SBL397201R4100	1.490
		24...60	20...60 (1)	0 0	AF80-40-00-11	1SBL397201R1100	1.490
		48...130	48...130	0 0	AF80-40-00-12	1SBL397201R1200	1.490
		100...250	100...250	0 0	AF80-40-00-13	1SBL397201R1300	1.440
		250...500	250...500	0 0	AF80-40-00-14	1SBL397201R1400	1.440
<b>2 N.O. + 2 N.C. Main Poles</b>							
70	60	24...60	-	0 0	AF40-22-00-41	1SBL347501R4100	1.210
		24...60	20...60 (1)	0 0	AF40-22-00-11	1SBL347501R1100	1.210
		48...130	48...130	0 0	AF40-22-00-12	1SBL347501R1200	1.210
		100...250	100...250	0 0	AF40-22-00-13	1SBL347501R1300	1.160
		250...500	250...500	0 0	AF40-22-00-14	1SBL347501R1400	1.160
125	105	24...60	-	0 0	AF80-22-00-41	1SBL397501R4100	1.490
		24...60	20...60 (1)	0 0	AF80-22-00-11	1SBL397501R1100	1.490
		48...130	48...130	0 0	AF80-22-00-12	1SBL397501R1200	1.490
		100...250	100...250	0 0	AF80-22-00-13	1SBL397501R1300	1.440
		250...500	250...500	0 0	AF80-22-00-14	1SBL397501R1400	1.440

(1) AF.....-11 not suitable for direct control by PLC-output.

(2) In progress.

#### Main dimensions mm, inches

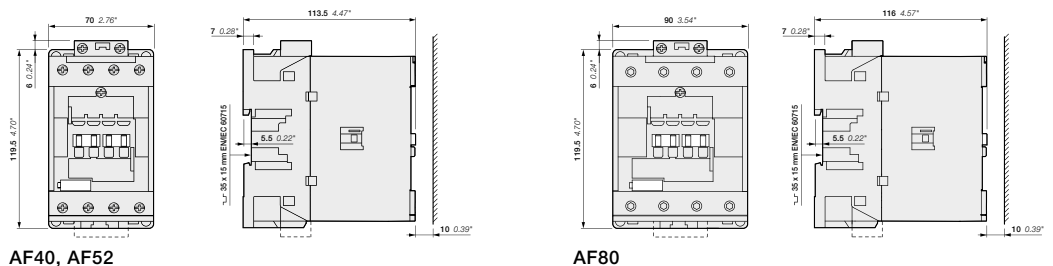

AF40, AF52

AF80

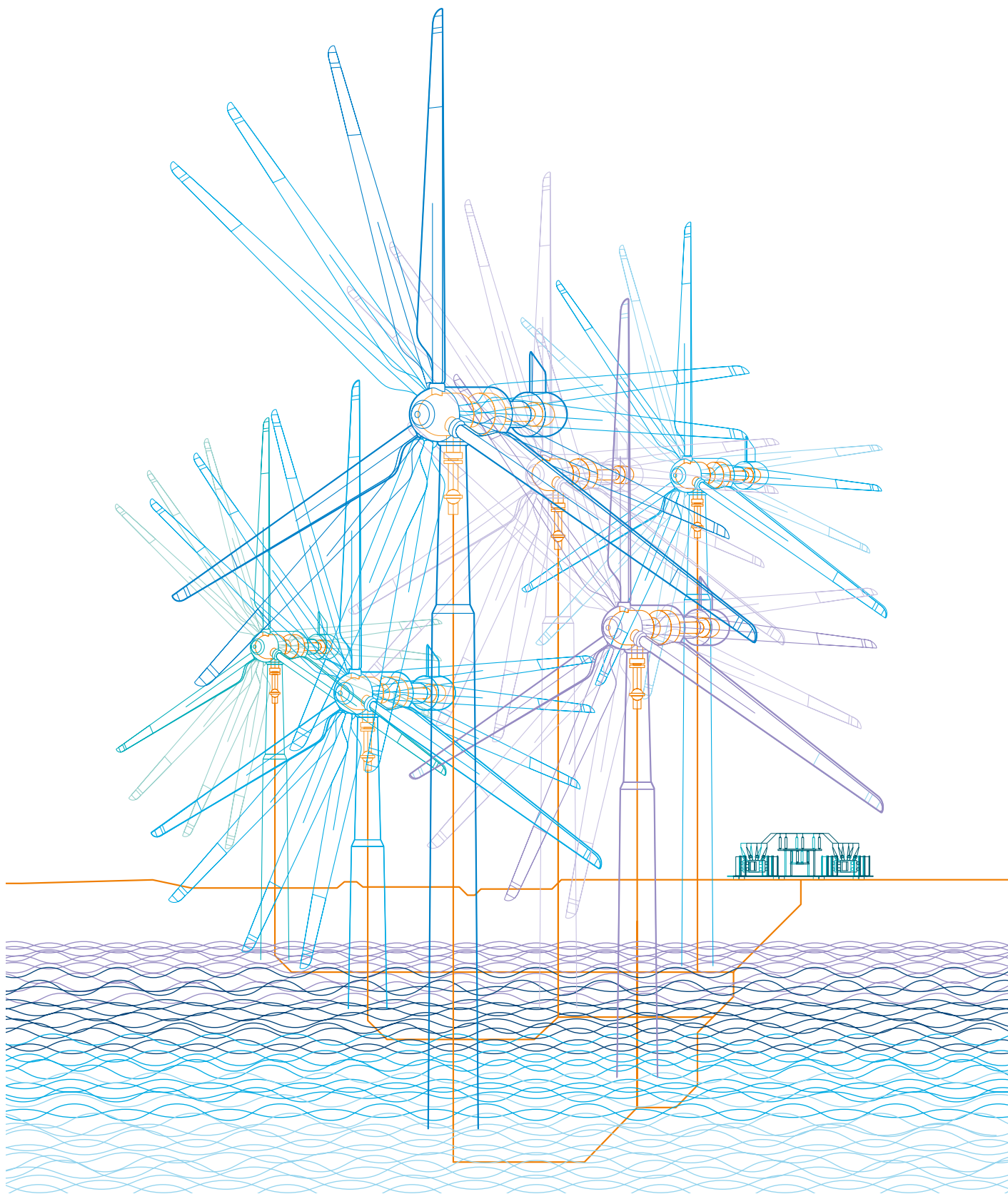

# AF09 ... AF80 4-pole contactors

## Main accessories

### Contactor and main accessories (other accessories available)

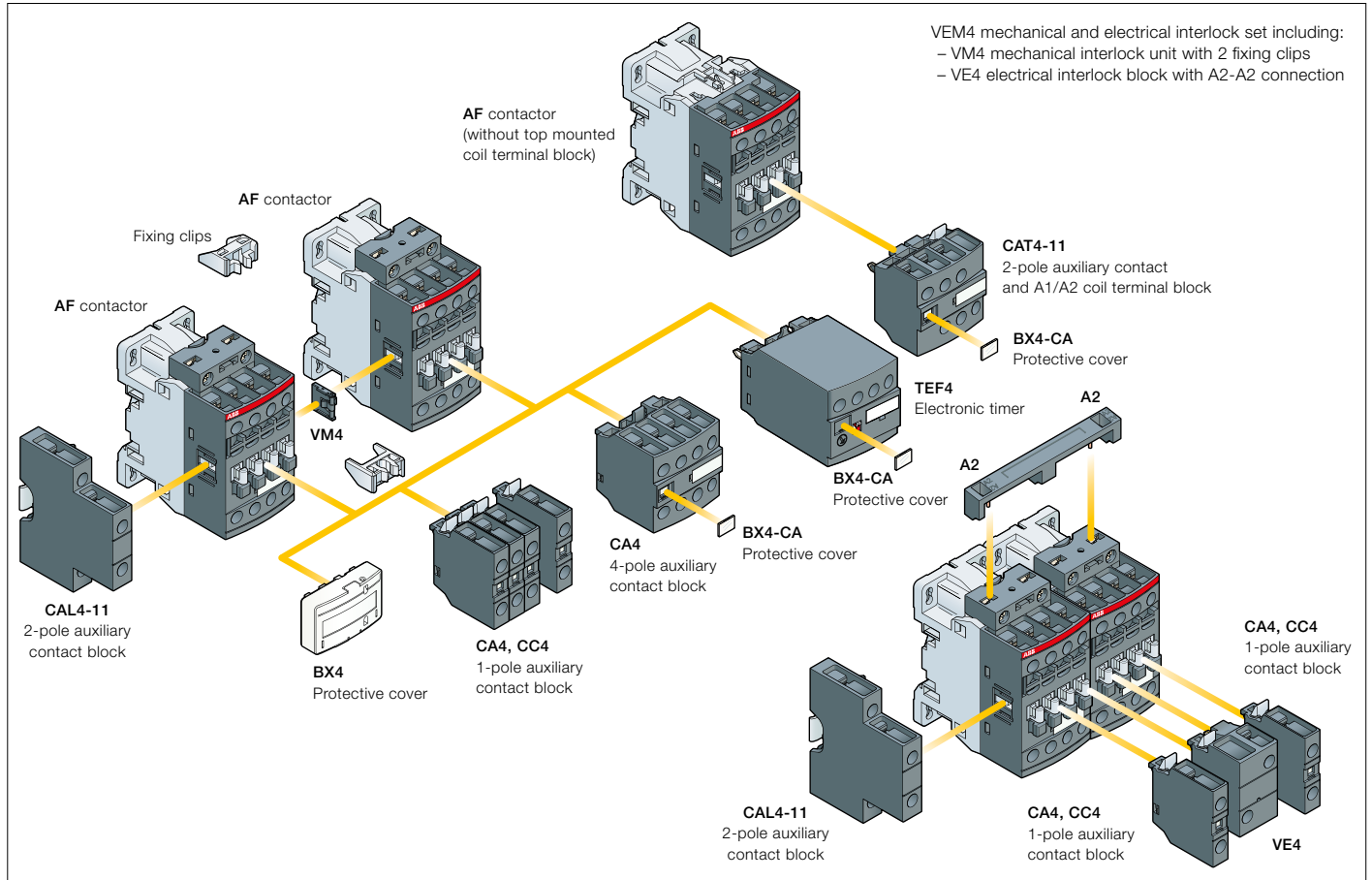

### Main accessory fitting details

Many configurations of accessories are possible depending on whether these are front-mounted or side-mounted.

Contactor types	Main poles	Built-in auxiliary contacts	Front-mounted accessories					Side-mounted accessories	
			Auxiliary contact blocks			Electronic timer	Electrical and mechanical interlock set (between 2 contactors)	Auxiliary contact blocks	
			1-pole CA4 1-pole CC4	2-pole CAT4-11	4-pole CA4	TEF4	VEM4	Left side 2-pole CAL4-11	Right side
Max. add-on N.C. auxiliary contacts: 4 N.C. max. on positions 1, 2, 3, 4 and 3 N.C. max. on positions 1 ±30°, 5									
AF09 ... AF16	4	0	0	0	4 max. or 1	or 1	or 1	+	1
					2 max. or 1	-	or 1	+	1
					3 max. -	-	-	+	1
Max. add-on N.C. auxiliary contacts: 3 N.C. max. on positions 1, 2, 3, 4 and 2 N.C. max. on positions 1 ±30°, 5									
AF26 ... AF38	4	0	0	0	4 max. or 1	or 1	or 1	+	1
					2 max. or 1	-	or 1	+	1
					3 max. -	-	-	+	1
Max. add-on N.C. auxiliary contacts: 6 N.C. max. on positions 1, 1 ±30°, 2, 3, 4, 5									
AF40 ... AF52	4	0	0	0	4 max. or 1	or 1	or 1	+	1
AF80	4	0	0	0	4 max. -	or 1	or 1	+	1
Max. add-on N.C. auxiliary contacts: 3 N.C. max. on positions 1, 2, 3, 4 and 2 N.C. max. on positions 1 ±30°, 5									
AF09 ... AF16	2	2	0	0	4 max. or 1	or 1	or 1	+	1
AF26 ... AF38	2	2	0	0	2 max. or 1	-	or 1	+	1
Max. add-on N.C. auxiliary contacts: 2 N.C. max. on positions 1, 1 ±30°, 2, 3, 4, 5									
AF40	2	2	0	0	4 max. or 1	or 1	or 1	+	1
	2	2	0	0	4 max. -	or 1	or 1	+	1
AF80	2	2	0	0	4 max. -	or 1	or 1	+	1



# AF09 ... AF80 4-pole contactors

## Main accessories



CA4-10



CAL4-11



CA4-22E



CAT4-11E



VEM4

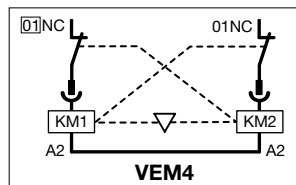

TEF4-ON

### Ordering details (1)

For contactors	Auxiliary contacts	Type	Order code	Pkg qty	Weight (1 pce)
					kg

#### Front-mounted instantaneous auxiliary contact blocks

AF09 ... AF80-40-00	1 0	- -	CA4-10	1SBN010110R1010	1	0.014
AF09 ... AF80-22-00	1 0	- -	CA4-10-T	1SBN010110T1010	10	0.014
	0 1	- -	CA4-01	1SBN010110R1001	1	0.014
	0 1	- -	CA4-01-T	1SBN010110T1001	10	0.014
	2 2	- -	CA4-22E	1SBN010140R1022	1	0.055
	3 1	- -	CA4-31E	1SBN010140R1031	1	0.055
	4 0	- -	CA4-40E	1SBN010140R1040	1	0.055
AF09 ... AF16...-40-00	0 4	- -	CA4-04E	1SBN010140R1004	1	0.055

#### Front-mounted auxiliary contact blocks with N.O. leading contact and N.C. lagging contact

AF09 ... AF80-40-00	- -	1 0	CC4-10	1SBN010111R1010	1	0.014
AF09 ... AF80-22-00	- -	0 1	CC4-01	1SBN010111R1001	1	0.014

#### Side-mounted instantaneous auxiliary contact blocks

AF09 ... AF80-40-00	1 1	- -	CAL4-11	1SBN010120R1011	1	0.040
AF09 ... AF80-22-00	1 1	- -	CAL4-11-T	1SBN010120T1011	10	0.040

#### Front-mounted instantaneous auxiliary contact and A1/A2 coil terminal blocks

AF09 ... AF52...-40-00	1 1	- -	CAT4-11E	1SBN010151R1011	1	0.040
AF09 ... AF40...-22-00						

Note: CAT4 not suitable for AF..Z contactors with DC control voltage 12...20 V DC.

#### Mechanical interlock unit

AF09 ... AF38...-40-00			VM4	1SBN030105T1000	10	0.005
AF40 ... AF80...-40-00			VM96-4	1SBN033405T1000	10	0.006

Note: VM4 includes 2 fixing clips (BB4) to maintain together both contactors.

#### Mechanical and electrical interlock set

AF09, AF16...-40-00	0 2	- -	VEM4	1SBN030111R1000	1	0.035
AF26, AF38...-40-00						

Note: - VEM4 includes a VM4 mechanical interlock unit with 2 fixing clips (BB4), a VE4 electrical interlock block. VE4 block must be used with A2-A2 connection to respect the electrical connection diagram.

- VEM4 not suitable for AF..Z contactors with DC control voltage 12...20 V DC.

For contactors	Time delay range selected by switch	Delay type	Auxiliary contacts	Type	Order code	Pkg qty	Weight (1 pce)
							kg

#### Electronic timers

AF09 ... AF80	0.1...1 s	ON-delay	1 1	TEF4-ON	1SBN020112R1000	1	0.065
	1...10 s						
	10...100 s	OFF-delay	1 1	TEF4-OFF	1SBN020114R1000	1	0.065

Note: Rated control circuit voltage Uc 24...240 V 50/60 Hz or DC.

(1) For more information, refer to main catalog "Accessories" section.

# AF116 ... AF140 4-pole contactors

## 160 to 200 A AC-1

### AC / DC operated with 1 N.O. + 1 N.C. auxiliary contacts



1SFC101154V0001

AF140-40-11



1SFC101192V0001

AF140-40-11B

#### Description

AF116 ... AF140 4-pole contactors are mainly used for controlling non-inductive or slightly inductive loads (i.e. resistance furnaces...) and generally for controlling power circuits up to 690 V AC. These contactors are of the block type design with 4 main poles.

- control circuit: AC or DC operated with electronic coil interface accepting a wide control voltage range (e.g. 100...250 V AC and DC), only 4 coils to cover control voltages between 24...500 V 50/60 Hz and 20...500 V DC
- can manage large control voltage variations
- reduced panel energy consumption
- very distinct closing and opening
- can withstand short voltage dips and voltage sags (SEMI F47 conditions of use on request).
- built-in surge suppression
- add-on auxiliary contact blocks for side mounting and a wide range of accessories.

#### Ordering details

IEC Rated operational current $\theta \leq 40^\circ\text{C}$ AC-1 A	UL / CSA General use rating 600 V AC A	Rated control circuit voltage Uc min. ... Uc max. V 50/60 Hz    V DC		Auxiliary contacts fitted 	Type (1)	Order code	Weight Pkg (1 pce) kg
--	--	---	--	---	-------------	------------	--------------------------------

#### 4 N.O. main poles

##### For connection with built-in cable clamps

Rated current (A)	UL/CSA rating (A)	Uc min. (V)	Uc max. (V)	N.O.	N.C.	Type	Order code	Weight (kg)
160	160	24...60	20...60	1	1	AF116-40-11-11	1SFL427101R1111	2.270
		48...130	48...130	1	1	AF116-40-11-12	1SFL427101R1211	2.270
		100...250	100...250	1	1	AF116-40-11-13	1SFL427101R1311	2.270
		250...500	250...500	1	1	AF116-40-11-14	1SFL427101R1411	2.270
200	175	24...60	20...60	1	1	AF140-40-11-11	1SFL447101R1111	2.270
		48...130	48...130	1	1	AF140-40-11-12	1SFL447101R1211	2.270
		100...250	100...250	1	1	AF140-40-11-13	1SFL447101R1311	2.270
		250...500	250...500	1	1	AF140-40-11-14	1SFL447101R1411	2.270

##### With bar connections

Rated current (A)	UL/CSA rating (A)	Uc min. (V)	Uc max. (V)	N.O.	N.C.	Type	Order code	Weight (kg)
160	160	24...60	20...60	1	1	AF116-40-11B-11	1SFL427102R1111	2.170
		48...130	48...130	1	1	AF116-40-11B-12	1SFL427102R1211	2.170
		100...250	100...250	1	1	AF116-40-11B-13	1SFL427102R1311	2.170
		250...500	250...500	1	1	AF116-40-11B-14	1SFL427102R1411	2.170
200	175	24...60	20...60	1	1	AF140-40-11B-11	1SFL447102R1111	2.170
		48...130	48...130	1	1	AF140-40-11B-12	1SFL447102R1211	2.170
		100...250	100...250	1	1	AF140-40-11B-13	1SFL447102R1311	2.170
		250...500	250...500	1	1	AF140-40-11B-14	1SFL447102R1411	2.170

(1) For other auxiliary contacts arrangements, please contact your ABB local organization.

#### Main dimensions mm, inches

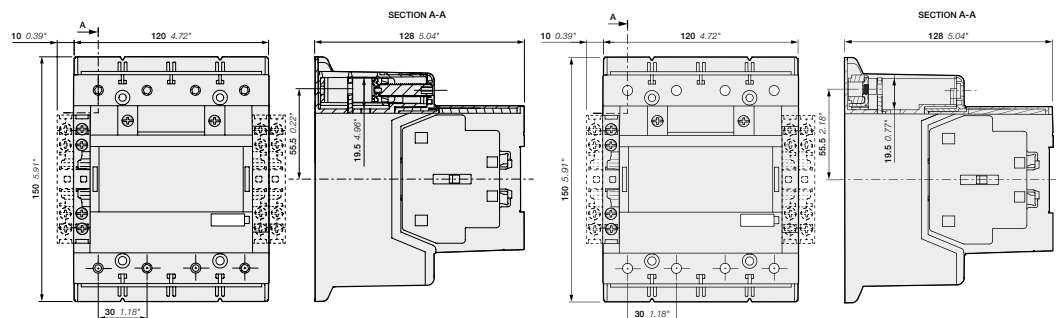

AF116, AF140-40-11

AF116, AF140-40-11B

1SFC101198C0201 - Rev. A

# AF190 ... AF370 4-pole contactors

## 275 to 525 A AC-1

### AC / DC operated with 1 N.O. + 1 N.C. auxiliary contacts

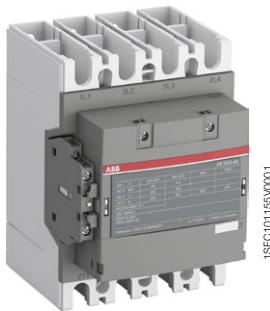

AF205-40-11



AF370-40-11

#### Description

AF190 ... AF370 4-pole contactors are mainly used for controlling non-inductive or slightly inductive loads (i.e. resistance furnaces...) and generally for controlling power circuits up to 1000 V AC. These contactors are of the block type design with 4 main poles.

- control circuit: AC or DC operated with electronic coil interface accepting a wide control voltage range (e.g. 100...250 V AC and DC), only 4 coils to cover control voltages between 24...500 V 50/60 Hz and 20...500 V DC
- can manage large control voltage variations
- reduced panel energy consumption
- very distinct closing and opening
- can withstand short voltage dips and voltage sags (SEMI F47 conditions of use on request).
- built-in surge suppression
- add-on auxiliary contact blocks for side mounting and a wide range of accessories.

#### Ordering details

IEC Rated operational current $\theta \leq 40^\circ\text{C}$ AC-1 A	UL / CSA General use rating 600 V AC A	Rated control circuit voltage Uc min. ... Uc max. V 50/60 Hz   V DC		Auxiliary contacts fitted 		Type (1)	Order code	Weight Pkg (1 pce) kg
<b>4 N.O. main poles</b>								
275	230	24...60	20...60	1	1	AF190-40-11-11	1SFL487102R1111	3.920
		48...130	48...130	1	1	AF190-40-11-12	1SFL487102R1211	3.920
		100...250	100...250	1	1	AF190-40-11-13	1SFL487102R1311	3.920
		250...500	250...500	1	1	AF190-40-11-14	1SFL487102R1411	3.920
350	250	24...60	20...60	1	1	AF205-40-11-11	1SFL527102R1111	3.920
		48...130	48...130	1	1	AF205-40-11-12	1SFL527102R1211	3.920
		100...250	100...250	1	1	AF205-40-11-13	1SFL527102R1311	3.920
		250...500	250...500	1	1	AF205-40-11-14	1SFL527102R1411	3.920
400	300	24...60	20...60	1	1	AF265-40-11-11	1SFL547102R1111	6.380
		48...130	48...130	1	1	AF265-40-11-12	1SFL547102R1211	6.380
		100...250	100...250	1	1	AF265-40-11-13	1SFL547102R1311	6.380
		250...500	250...500	1	1	AF265-40-11-14	1SFL547102R1411	6.380
500	350	24...60	20...60	1	1	AF305-40-11-11	1SFL587102R1111	6.380
		48...130	48...130	1	1	AF305-40-11-12	1SFL587102R1211	6.380
		100...250	100...250	1	1	AF305-40-11-13	1SFL587102R1311	6.380
		250...500	250...500	1	1	AF305-40-11-14	1SFL587102R1411	6.380
525	420	24...60	20...60	1	1	AF370-40-11-11	1SFL607102R1111	6.380
		48...130	48...130	1	1	AF370-40-11-12	1SFL607102R1211	6.380
		100...250	100...250	1	1	AF370-40-11-13	1SFL607102R1311	6.380
		250...500	250...500	1	1	AF370-40-11-14	1SFL607102R1411	6.380

(1) For other auxiliary contacts arrangements, please contact your ABB local organization.

#### Main dimensions mm, inches

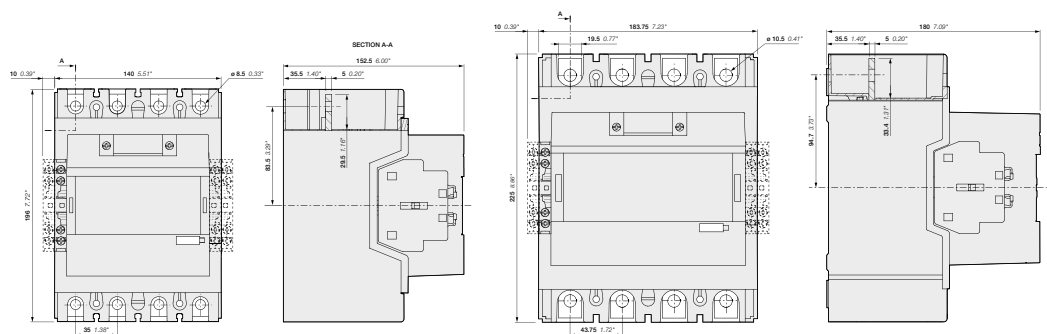

AF190, AF205

AF265, AF305, AF370

# AF116 ... AF370 4-pole contactors with 1 N.O. + 1 N.C. auxiliary contacts

## Main accessories

Main accessories (other accessories available)

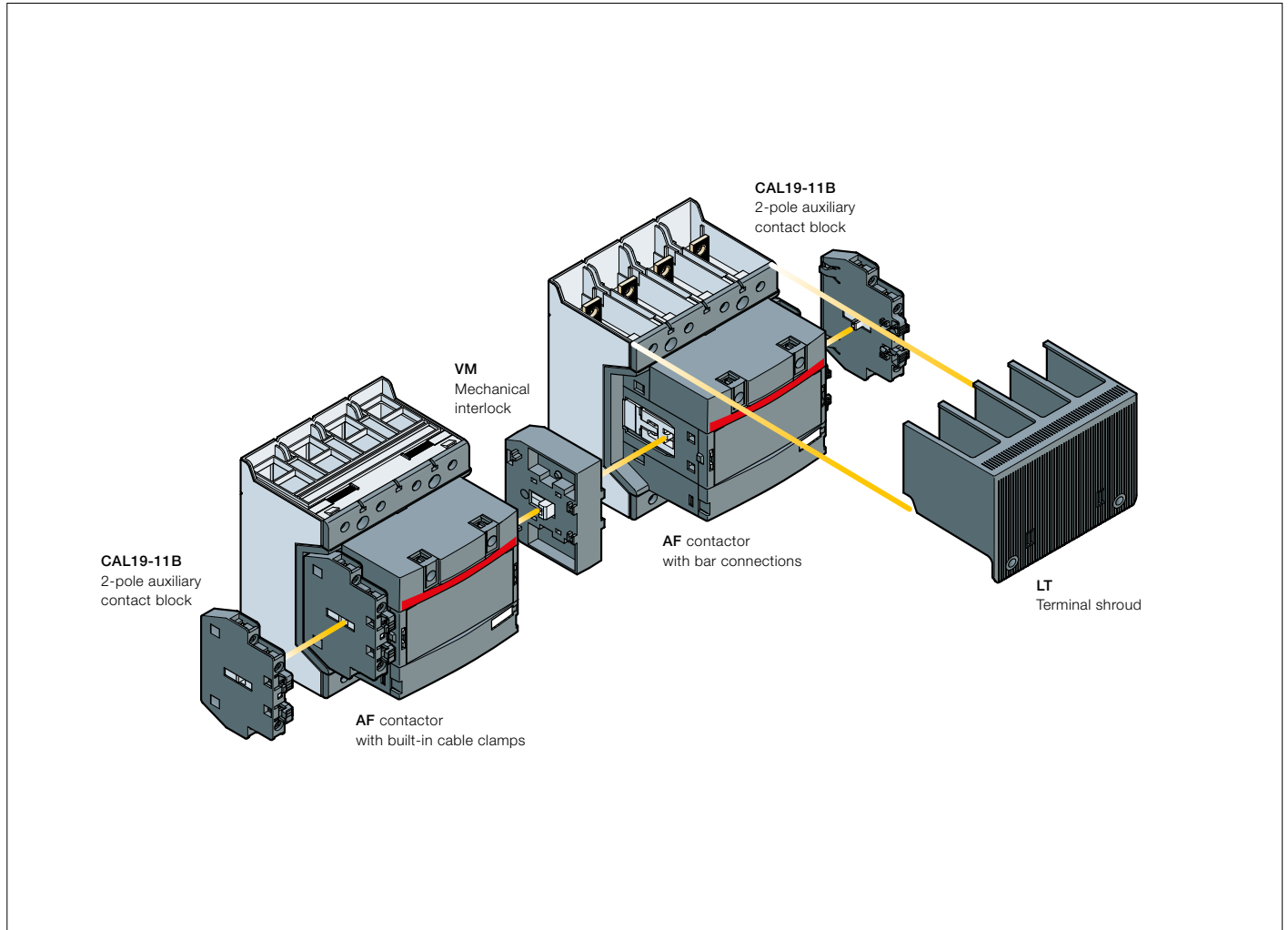

### Main accessory fitting details

Contactor types	Main poles	Available auxiliary contacts	Side-mounted accessories		
			Auxiliary contact blocks		Mechanical interlock units (between two contactors)
			CAL19-11	CAL19-11B	
AF116 ... AF370	4	0 1 1	1 x CAL19-11	+ 2 x CAL19-11B	-
AF116 ... AF370	4	0 1 1	-	+ 2 x CAL19-11B (1)	+ VM... (2)

(1) Total number of auxiliary contact blocks for the two contactors.

(2) Interlock type, according to the contactor ratings (see "Accessories").

# AF116 ... AF370 4-pole contactors with 1 N.O. + 1 N.C. auxiliary contacts Main accessories



CAL19-11

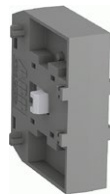

1SFC101071V0001



VM19

1SFC101035V0001

## Ordering details (1)

For contactors	Auxiliary contacts		Type	Order code	Pkg qty	Weight (1 pce)
						kg

## Side-mounted instantaneous auxiliary contact blocks

AF116 ... AF370	1	1	CAL19-11	1SFN010820R1011	2	0.050
	1	1	CAL19-11B	1SFN010820R3311	2	0.050

## Mechanical interlock unit

AF116 ... AF370		VM19	1SFN030300R1000	1	0.054
AF116 ... AF146 and AF190, AF205		VM140/190	1SFN034403R1000	1	0.088
AF190, AF205 and AF265 ... AF370		VM205/265	1SFN035203R1000	1	0.090

## Terminal shrouds

AF116 ... AF140, with compression lugs		LT140-40L	1SFN124203R2000	2	0.090
AF190 ... AF205, with cable clamps		LT205-40C	1SFN124801R2000	2	0.060
AF190 ... AF205, with compression lugs		LT205-40L	1SFN124803R2000	2	0.290
AF265 ... AF370, with cable clamps		LT370-40C	1SFN125401R2000	2	0.040
AF265 ... AF370, with compression lugs		LT370-40L	1SFN125403R2000	2	0.370

6

For contactors	Dimensions		Type	Order code	Pkg qty	Weight (1 pce)
	hole Ø mm	bar mm				

## Terminal enlargements

AF190 ... AF205	10.5	20 x 5	LW205-40	1SFN074807R2000	1	0.306
AF265 ... AF370	10.5	25 x 5	LW370-40	1SFN075407R2000	1	0.540

(1) For more information, refer to "Accessories" section.

# EK550, EK1000 4-pole contactors

## 800 to 1000 A AC-1

### AC operated - with 1 N.O. + 1 N.C. auxiliary contacts



1SFC381039-000

EK1000-40-11



#### Description

EK550 4-pole contactors are mainly used for controlling non-inductive or slightly inductive loads (i.e. resistance furnaces...) and generally for controlling power circuits up to 1000 V AC and 600 V DC, EK1000 up to 1000 V AC.

These contactors are of the block type design with:

- 4 main poles
- control circuit: AC operated
- add-on auxiliary contact blocks for side mounting and a wide range of accessories.

#### Ordering details

IEC Rated operational current $\theta \leq 40^\circ\text{C}$ AC-1	UL/CSA General use rating 600 V AC	Rated control circuit voltage $U_c$ (1)		Auxiliary contacts fitted		Type	Order code	Weight  Pkg (1 pce)  kg
		V 50 Hz	V 60 Hz					
800	540	48	-	1	1	EK550-40-11	SK827041-AD	17.200
		110	110...120	1	1	EK550-40-11	SK827041-EF	17.200
		110...115	115...127	1	1	EK550-40-11	SK827041-EG	17.200
		220	220...240	1	1	EK550-40-11	SK827041-EL	17.200
		220...230	230...255	1	1	EK550-40-11	SK827041-EM	17.200
		380	380...415	1	1	EK550-40-11	SK827041-EP	17.200
		380...400	400...440	1	1	EK550-40-11	SK827041-ER	17.200
		400...415	-	1	1	EK550-40-11	SK827041-AR	17.200
		1000	-	48	-	1	1	EK1000-40-11
110	110...120			1	1	EK1000-40-11	SK827044-EF	17.500
110...115	115...127			1	1	EK1000-40-11	SK827044-EG	17.500
220	220...240			1	1	EK1000-40-11	SK827044-EL	17.500
220...230	230...255			1	1	EK1000-40-11	SK827044-EM	17.500
380	380...415			1	1	EK1000-40-11	SK827044-EP	17.500
380...400	400...440			1	1	EK1000-40-11	SK827044-ER	17.500
400...415	-			1	1	EK1000-40-11	SK827044-AR	17.500

(1) Other control voltages see voltage code table.

#### Main dimensions mm, inches

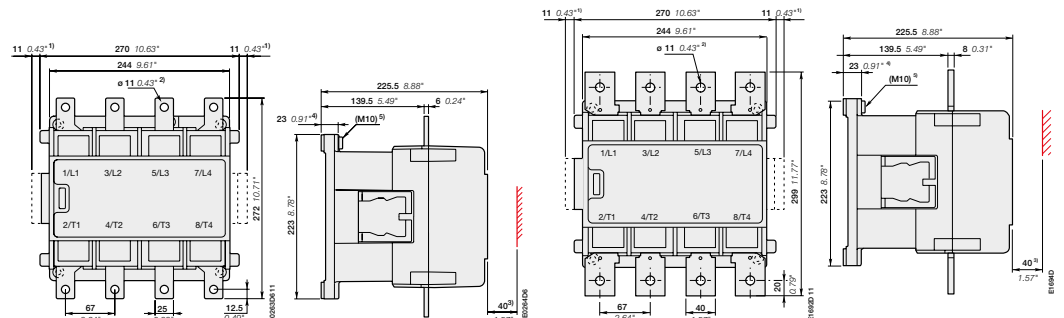

EK550

- 1) Dimension for extra auxiliary contact block.
- 2) Screw, nut and washer by-packed.
- 3) Min. distance to uninsulated wall.
- 4) Damping elements are included.
- 5) Earthing screw.

EK1000

# EK550, EK1000 4-pole contactors

## 800 to 1000 A AC-1

### DC operated - with 2 N.O. + 1 N.C. auxiliary contacts



EK1000-40-21

#### Description

EK550 4-pole contactors are mainly used for controlling non-inductive or slightly inductive loads (i.e. resistance furnaces...) and generally for controlling power circuits up to 1000 V AC and 600 V DC, EK1000 up to 1000 V AC.

These contactors are of the block type design with:

- 4 main poles
- control circuit: DC operated
- add-on auxiliary contact blocks for side mounting and a wide range of accessories.

#### Ordering details

IEC	UL / CSA	Rated control circuit voltage Uc	Auxiliary contacts fitted	Type	Order code	Weight		
Rated operational current $\theta \leq 40^\circ\text{C}$ AC-1	General use rating 600 V AC					Pkg (1 pce)		
A	A	V DC				kg		
800	540	24	2 1	EK550-40-21	SK827041-DB	17.200		
		36	2 1	EK550-40-21	SK827041-DC	17.200		
		48	2 1	EK550-40-21	SK827041-DD	17.200		
		60	2 1	EK550-40-21	SK827041-DT	17.200		
		75	2 1	EK550-40-21	SK827041-DG	17.200		
		110	2 1	EK550-40-21	SK827041-DE	17.200		
		125	2 1	EK550-40-21	SK827041-DU	17.200		
		220	2 1	EK550-40-21	SK827041-DF	17.200		
		1000	-	24	2 1	EK1000-40-21	SK827044-DB	17.500
				36	2 1	EK1000-40-21	SK827044-DC	17.500
48	2 1			EK1000-40-21	SK827044-DD	17.500		
60	2 1			EK1000-40-21	SK827044-DT	17.500		
75	2 1			EK1000-40-21	SK827044-DG	17.500		
110	2 1			EK1000-40-21	SK827044-DE	17.500		
125	2 1			EK1000-40-21	SK827044-DU	17.500		
220	2 1			EK1000-40-21	SK827044-DF	17.500		

#### Main dimensions mm, inches

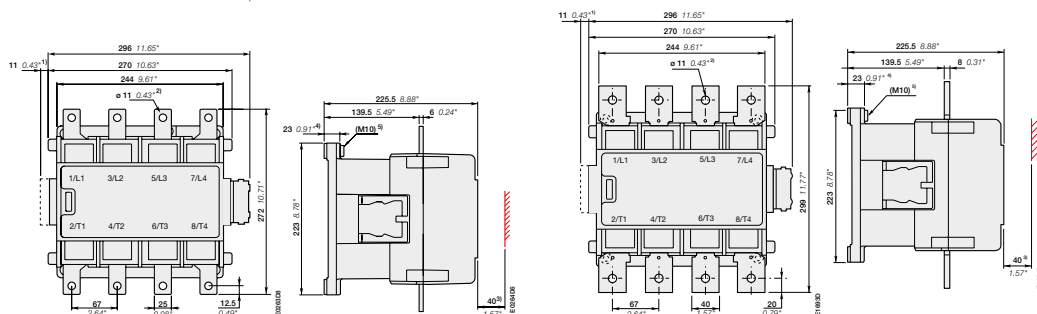

#### EK550

- 1) Dimension for extra auxiliary contact block.
- 2) Screw, nut and washer by-packed.
- 3) Min. distance to uninsulated wall.
- 4) Damping elements are included.
- 5) Earthing screw.

#### EK1000

# EK550, EK1000 4-pole contactors with 1 N.O. + 1 N.C. auxiliary contacts and 2 N.O. + 1 N.C. auxiliary contacts

## Main accessory fitting details

### Mounting positions of the auxiliary contact

### Auxiliary contact types and connecting diagrams

(1) Contact 35-36 used for some types of EK... contactors

## EK 4-pole contactors

Contactor types	Main poles	Available auxiliary contacts	Add-on auxiliary contact blocks	Mounting and positioning
<b>AC operated, 50 Hz, 60 Hz or 50/60 Hz</b>				
EK550, EK1000	4	0 1 1	+ 1 x CAL16-11B + 1 x CAL16-11C + 1 x CAL16-11D	
<b>DC operated</b>				
EK550, EK1000	4	0 2 1	+ 1 x CAL16-11C	

## EK 4-pole reversing contactors with VH800 mechanical and electrical interlock units

"Left hand" contactors	Interlocking	"Right hand" contactors	Add-on auxiliary contact blocks	Mounting and positioning
<b>AC operated, 50 Hz, 60 Hz or 50/60 Hz</b>				
EK550, EK1000	VH800	EK550, EK1000	+ 1 x CAL16-11C + 1 x CAL16-11D	
<b>DC operated</b>				
EK550, EK1000	VH800	EK550, EK1000	—	



# EK550, EK1000 4-pole contactors with 1 N.O. + 1 N.C. auxiliary contacts and 2 N.O. + 1 N.C. auxiliary contacts

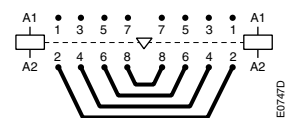

BSS550 ... BSS1000



RC-EH

## Ordering details (1)

For contactors	Auxiliary contacts	Type	Order code	Pkg qty	Weight (1 pce)
					kg

## Side-mounted auxiliary contact blocks

EK	1	1	CAL16-11B	SK829002-B	1	0.050
	1	1	CAL16-11C	SK829002-C	1	0.050
	1	1	CAL16-11D	SK829002-D	1	0.050
	1	1	CCL16-11E (2)	SK829002-E	1	0.050

## Mechanical interlock unit for two horizontal mounted contactors

EK550, EK1000	VH800	SK829070-F	1	6.000
---------------	-------	------------	---	-------

## Connecting sets

EK550	BSS550	SK829090-E	1	3.300
EK1000	BSS1000	SK829090-H	1	5.500

## Surge suppressors

For contactors	Rated control circuit voltage U <sub>c</sub>		Type	Order code	Pkg qty	Weight (1 pce)
	V	AC				
EK550, EK1000	48...110	●	-	RC-EH800/110	SK829007-C	1 0.015
EK550, EK1000	24...125	-	●	RC-EH800/110	SK829007-C	1 0.015
EK550, EK1000	220...600	●	-	RC-EH800/600	SK829007-D	1 0.015

(1) See "Main accessory fitting details" table.

(2) Mounting of CCL16-11E blocks does not allow an additional second block to be added on top of it. All DC operated EK contactors are equipped with one CCL16-11E on the right side.

# NF 4-pole contactor relays

## AC / DC operated



NF22E

### Description

NF contactor relays are used for switching auxiliary and control circuits.

These contactor relays are of the block type design with:

- 4 poles. Contactor relays have mechanically linked auxiliary contact elements (side-marked symbol)
- control circuit: AC or DC operated with electronic coil interface accepting a wide control voltage range (e.g. 100...250 V AC and DC)
  - can manage large control voltage variations
  - only 4 control voltage ranges covering 24...500 V 50/60 Hz and 20...500 V DC
  - reduced panel energy consumption
  - very distinct closing and opening.
- built-in surge suppression
- add-on auxiliary contact blocks for front or side mounting and a wide range of accessories.

### Ordering details

Number of contacts	Rated control circuit voltage		Type	Order code	Weight
	Uc min. ... Uc max.				
	V 50/60 Hz	V DC			kg
	24...60	-	(1) NF22E-41	1SBH137001R4122	0.270
	48...130	48...130	NF22E-12	1SBH137001R1222	0.270
	100...250	100...250	NF22E-13	1SBH137001R1322	0.270
	250...500	250...500	NF22E-14	1SBH137001R1422	0.310
	24...60	-	(1) NF31E-41	1SBH137001R4131	0.270
	48...130	48...130	NF31E-12	1SBH137001R1231	0.270
	100...250	100...250	NF31E-13	1SBH137001R1331	0.270
	250...500	250...500	NF31E-14	1SBH137001R1431	0.310
	24...60	-	(1) NF40E-41	1SBH137001R4140	0.270
	48...130	48...130	NF40E-12	1SBH137001R1240	0.270
	100...250	100...250	NF40E-13	1SBH137001R1340	0.270
	250...500	250...500	NF40E-14	1SBH137001R1440	0.310

(1) For 24...60 V 50/60 Hz - 20...60 V DC, use NF..E-21.

### Main dimensions mm, inches

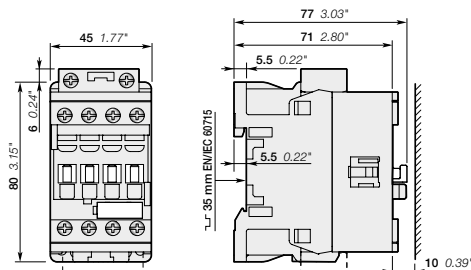

NF22E, NF31E, NF40E

# NFZ 4-pole contactor relays

## AC / DC operated - low consumption



NFZ22E

### Description

NFZ contactor relays are used for switching auxiliary and control circuits.

These contactor relays are of the block type design with:

- 4 poles. Contactor relays have mechanically linked auxiliary contact elements (side-marked symbol)
- control circuit: AC or DC operated with electronic coil interface accepting a wide control voltage range (e.g. 100...250 V AC and DC)
  - can manage large control voltage variations
  - only 4 control voltage ranges covering 24...250 V 50/60 Hz and 12...250 V DC
  - allow direct control by PLC-output  $\geq 24$  V DC 500 mA
  - reduced panel energy consumption
  - very distinct closing and opening
  - can withstand short voltage dips and voltage sags (SEMI F47-0706 conditions of use on request).
- built-in surge suppression
- add-on auxiliary contact blocks for front or side mounting and a wide range of accessories.

### Ordering details

Number of contacts	Rated control circuit voltage Uc min. ... Uc max.		Type	Order code	Weight Pkg (1 pce) kg
	V 50/60 Hz	V DC			
	-	12...20	NFZ22E-20	1SBH136001R2022	0.310
	24...60	20...60	NFZ22E-21	1SBH136001R2122	0.310
	48...130	48...130	NFZ22E-22	1SBH136001R2222	0.310
	100...250	100...250	NFZ22E-23	1SBH136001R2322	0.310
	-	12...20	NFZ31E-20	1SBH136001R2031	0.310
	24...60	20...60	NFZ31E-21	1SBH136001R2131	0.310
	48...130	48...130	NFZ31E-22	1SBH136001R2231	0.310
	100...250	100...250	NFZ31E-23	1SBH136001R2331	0.310
	-	12...20	NFZ40E-20	1SBH136001R2040	0.310
	24...60	20...60	NFZ40E-21	1SBH136001R2140	0.310
	48...130	48...130	NFZ40E-22	1SBH136001R2240	0.310
	100...250	100...250	NFZ40E-23	1SBH136001R2340	0.310

Note: Only NFZ contactor relays with DC control voltage 12...20 V DC need to respect the connection polarities indicated close to the coil terminals: A1+ for the positive pole and A2- for the negative pole.

### Main dimensions mm, inches

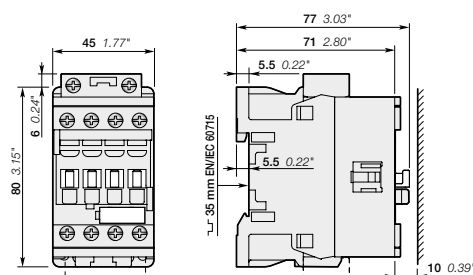

NFZ22E, NFZ31E, NFZ40E

# NF 4-pole contactor relays

## Main accessories

### Contactor relays and main accessories (other accessories available)

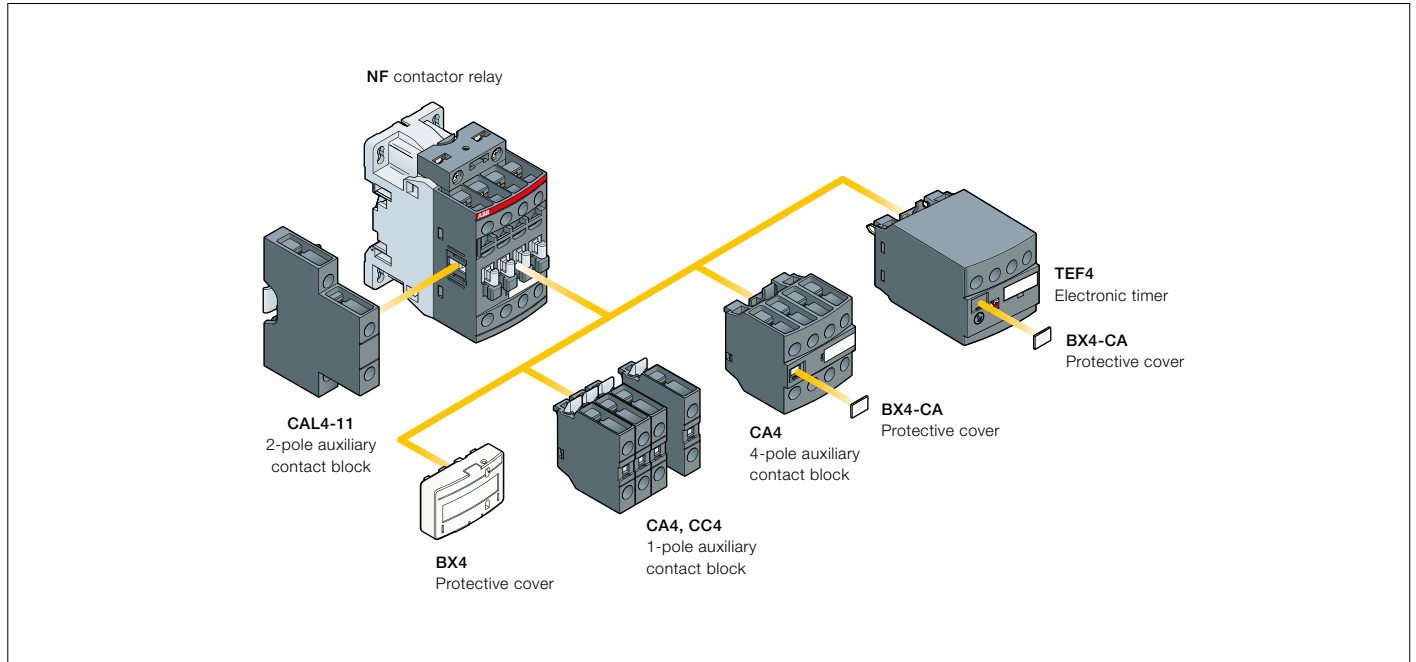

6

### Main accessory fitting details

Many configurations of accessories are possible depending on whether these are front-mounted or side-mounted.

Contactor relay types	Main poles	Front-mounted accessories			Side-mounted accessories	
		Auxiliary contact blocks		Electronic timer	Auxiliary contact blocks	
		1-pole CA4	4-pole CA4	TEF4	Left side 2-pole CAL4-11	Right side
		Max. add-on N.C. auxiliary contacts: 3 N.C. max. on positions 1, 2, 3, 4 and 2 N.C. max. on positions 1 ±30°, 5				
NF	2 2 E	4 max.	or 1	or 1	+ 1	-
	3 1 E	2 max.	-	or 1	+ 1	+ 1
		Max. add-on N.C. auxiliary contacts: 4 N.C. max. on positions 1, 2, 3, 4 and 3 N.C. max. on positions 1 ±30°, 5				
NF	4 0 E	4 max.	or 1	or 1	+ 1	-
		2 max.	-	or 1	+ 1	+ 1

# NF 4-pole contactor relays

## Main accessories



CA4-10



CA4-22N



CAL4-11



TEF4-ON



LDC4



BX4



BX4-CA

### Ordering details (1)

For contactor relays	Auxiliary contacts	Type	Order code	Pkg qty	Weight (1 pce)
					kg

#### Front-mounted instantaneous auxiliary contact blocks

4-pole NF	NO	NC	Type	Order code	Pkg qty	Weight (1 pce)
1 0	-	-	CA4-10	1SBN010110R1010	1	0.014
1 0	-	-	CA4-10-T	1SBN010110T1010	10	0.014
0 1	-	-	CA4-01	1SBN010110R1001	1	0.014
0 1	-	-	CA4-01-T	1SBN010110T1001	10	0.014
4 0	-	-	CA4-40N	1SBN010140R1240	1	0.055
3 1	-	-	CA4-31N	1SBN010140R1231	1	0.055
2 2	-	-	CA4-22N	1SBN010140R1222	1	0.055
1 3	-	-	CA4-13N	1SBN010140R1213	1	0.055
NF..40E	0 4	-	CA4-04N	1SBN010140R1204	1	0.055

#### Front-mounted auxiliary contact blocks with N.O. leading contact and N.C. lagging contact

4-pole NF	NO	NC	Type	Order code	Pkg qty	Weight (1 pce)
-	-	1 0	CC4-10	1SBN010111R1010	1	0.014
-	-	0 1	CC4-01	1SBN010111R1001	1	0.014

#### Side-mounted instantaneous auxiliary contact blocks

NF	NO	NC	Type	Order code	Pkg qty	Weight (1 pce)
1 1	-	-	CAL4-11	1SBN010120R1011	1	0.040
1 1	-	-	CAL4-11-T	1SBN010120T1011	10	0.040

For contactors	Time delay range selected by switch	Delay type	Auxiliary contacts	Type	Order code	Pkg qty	Weight (1 pce)
							kg

#### Electronic timers

NF	Time delay range	Delay type	NO	NC	Type	Order code	Pkg qty	Weight (1 pce)
	0.1...1 s	ON-delay	1	1	TEF4-ON	1SBN020112R1000	1	0.065
	1...10 s	OFF-delay	1	1	TEF4-OFF	1SBN020114R1000	1	0.065
	10...100 s							

Note: Rated control circuit voltage U<sub>c</sub> 24...240 V 50/60 Hz or DC.

#### Additional coil terminal block

NF	Type	Order code	Pkg qty	Weight (1 pce)
	LDC4	1SBN070156T1000	10	0.010

#### Protective covers

All 1-stack contactor relays	Type	Order code	Pkg qty	Weight (1 pce)
	BX4	1SBN110108T1000	10	0.006
4-pole CA4 auxiliary contact blocks and TEF4 electronic timer	Type	Order code	Pkg qty	Weight (1 pce)
	BX4-CA	1SBN110109W1000	50	0.001

(1) For more information, refer to main catalog "Accessories" section.

# Voltage code table

The below tables indicate the available coil voltages and corresponding digits for order codes. When placing an order, please give the order code. Select a standard contactor from ordering detail pages. Change the **coil voltage code** in the order code according to the table below. Example: for contactor AF400-30-11 and coil 100...250 V 50/60 Hz, the order code is 1SFL577001R7011.

## AF09 ... AF370 3-pole contactors AF09 ... AF370 4-pole contactors

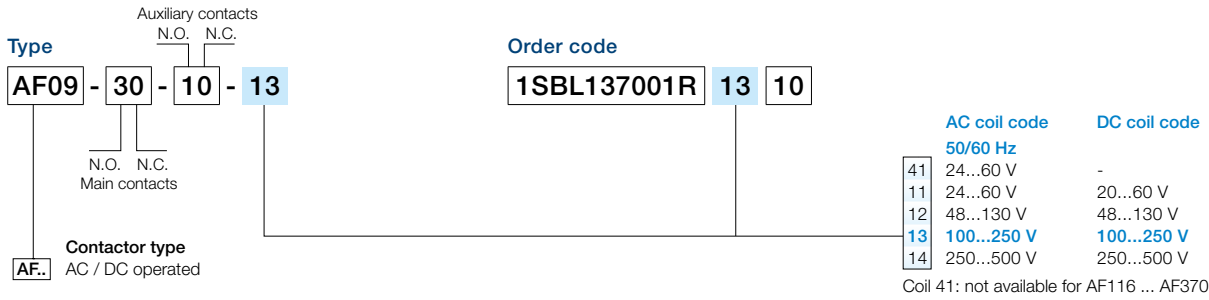

## AF116 ... AF370 3-pole contactors with built-in PLC interface

	AC coil code 50/60 Hz	DC coil code
33	100...250 V	100...250 V
34	250...500 V	250...500 V

## AF400 ... AF2650 3-pole contactors

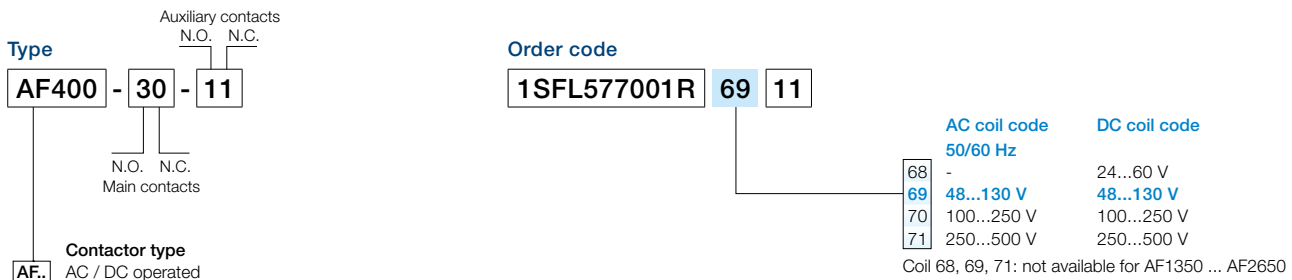

## AF09 ... AF38 3- and 4-pole contactors - low consumption

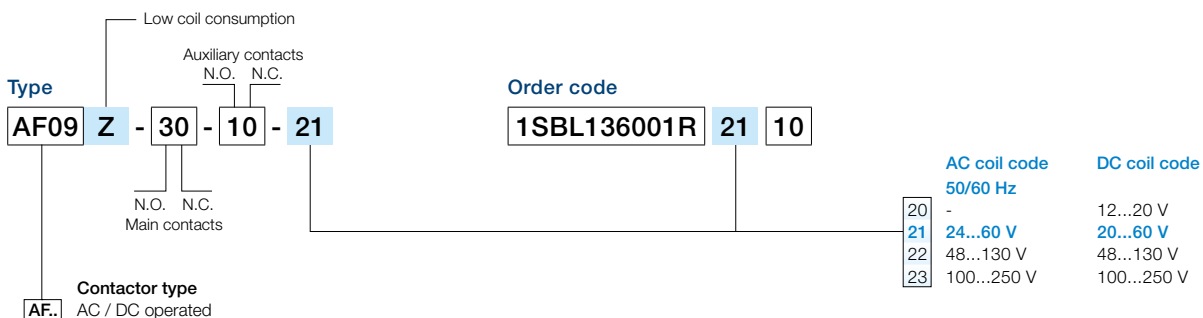

# Voltage code table

## NF contactor relays



## NF contactor relays with overlapping of lagging / leading contacts

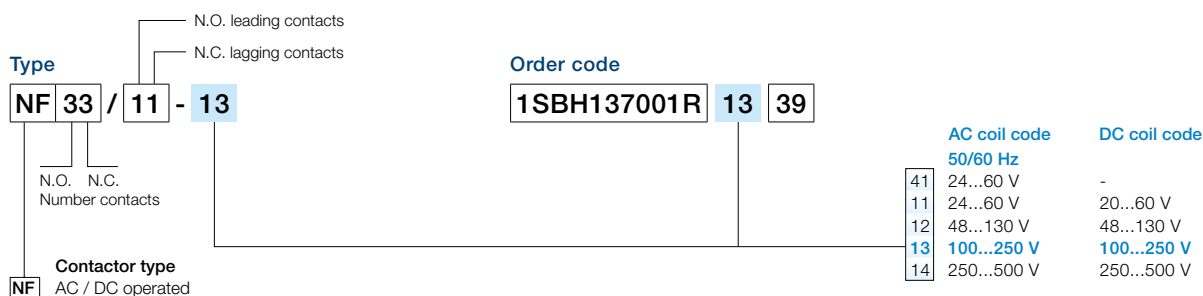

## NF contactor relays - low consumption

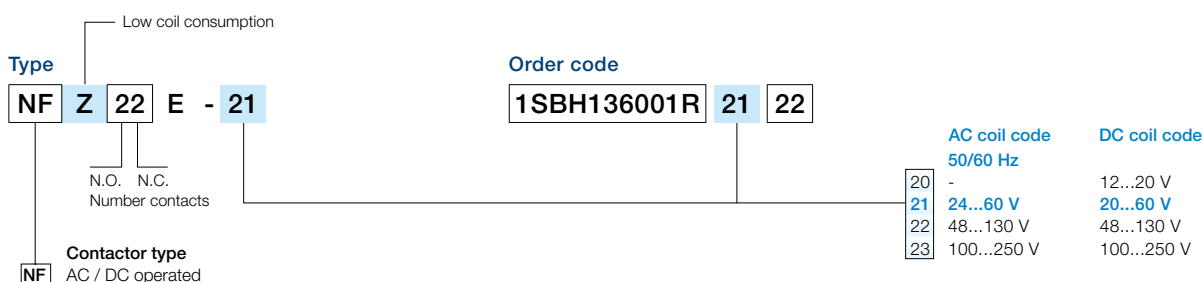

## NF contactor relays with overlapping of lagging / leading contacts - low consumption

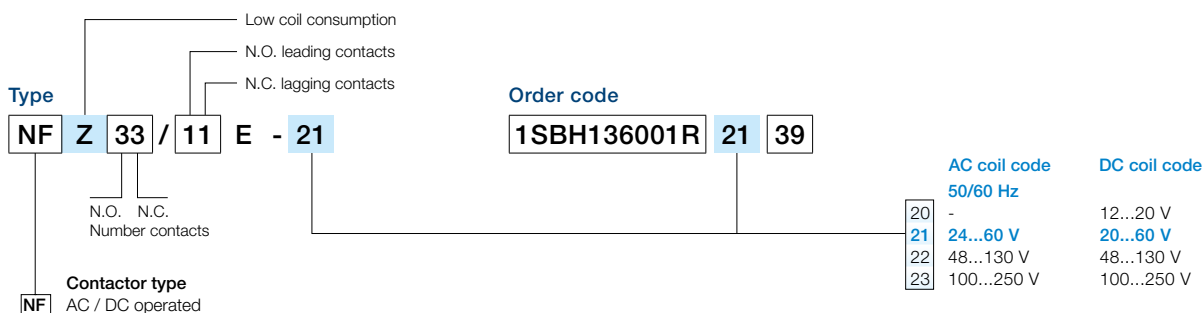

# Voltage code table

## UA, UA..RA contactors GA contactors

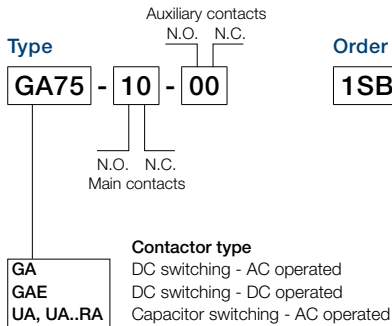

**Order code**  
**1SBL411025R** **82** **00**

**Contactors: UA, UA..RA, GA**  
**AC coil code**

	50 Hz	60 Hz
<b>81</b>	<b>24 V</b>	<b>24 V</b>
16	26 V	28 V
17	28 V	32 V
<b>82</b>	<b>42 V</b>	<b>42 V</b>
20	42 V	48 V
<b>83</b>	<b>48 V</b>	<b>48 V</b>
<b>73</b>	<b>60 V</b>	<b>60 V</b>
<b>74</b>	<b>100 V</b>	<b>100...110 V</b>
26	105 V	110...127 V
<b>84</b>	<b>110 V</b>	<b>110...120 V</b>
<b>89</b>	<b>110...115 V</b>	<b>115...127 V</b>
29	120 V	140 V
30	125...127 V	150 V
34	175 V	208 V
36	190 V	220 V
40	210 V	240 V
<b>80</b>	<b>220...230 V</b>	<b>230...240 V</b>
<b>88</b>	<b>230...240 V</b>	<b>240...260 V</b>
42	230...240 V	277 V
<b>85</b>	<b>380...400 V</b>	<b>400...415 V</b>
<b>86</b>	<b>400...415 V</b>	<b>415...440 V</b>
50	400 V	440 V
51	400...415 V	480 V
<b>87</b>	<b>415...440 V</b>	<b>440...460 V</b>
53	440 V	500 V
55	500 V	600 V
56	550 V	-
58	660...690 V	-
59	-	690 V

**Contactors: GAE**  
**DC coil code**

<b>80</b>	12 V
<b>81</b>	24 V
<b>82</b>	42 V
<b>83</b>	48 V
21	50 V
<b>84</b>	60 V
<b>85</b>	75 V
<b>86</b>	110 V
<b>87</b>	125 V
<b>88</b>	220 V
<b>89</b>	240 V
<b>38</b>	250 V

Codes in bold for dual frequency coils.

## EK550, EK1000 contactors

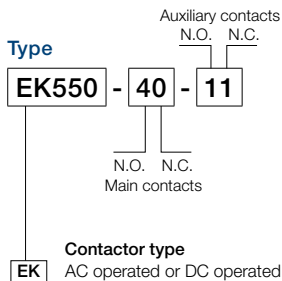

**Order code**  
**SK827041** - **AD**

**AC coil code**

	50 Hz	60 Hz
<b>AD</b>	<b>48 V</b>	-
AE	-	110 V
AF	110 V	120 V
AG	127 V	-
AZ	-	208 V
AH	190 V	220 V
AK	-	240 V
AL	220...230 V	240 V
AM	230...240 V	-
AN	-	380 V
AP	380...400 V	440 V
AR	400...415 V	-
AS	-	480 V
AT	440 V	-
AU	500 V	-
AV	-	600 V

**Dual frequency coil code**

	50 Hz	60 Hz
EF	110 V	110...120 V
EG	110...115 V	115...127 V
EL	220 V	220...240 V
EM	220...230 V	230...255 V
EP	380 V	380...415 V
ER	380...400 V	400...440 V

2 auxiliary contact blocks maximum per contactor, ambient temperature ≤ 55 °C and mounting positions 2 and 6 excluded.

**DC coil code**

DB	24 V
DC	36 V
DD	48 V
DT	60 V
DG	75 V
DE	110 V
DU	125 V
DF	220 V



# Voltage code table

## GAF185 ... GAF300 contactors

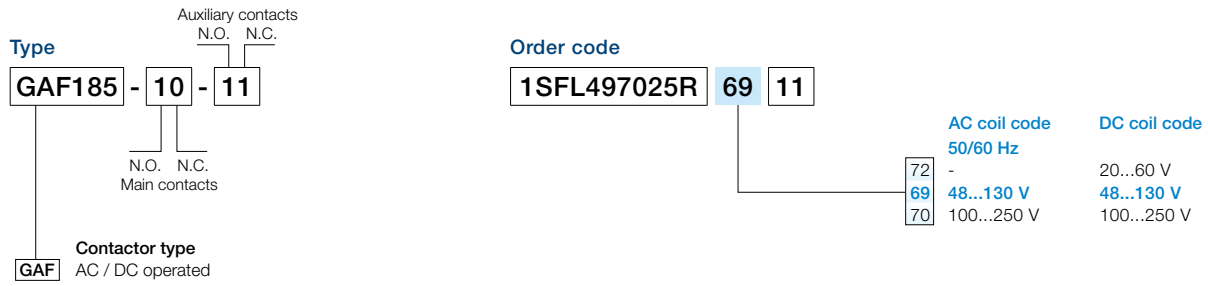

## GAF460 ... GAF1250 contactors

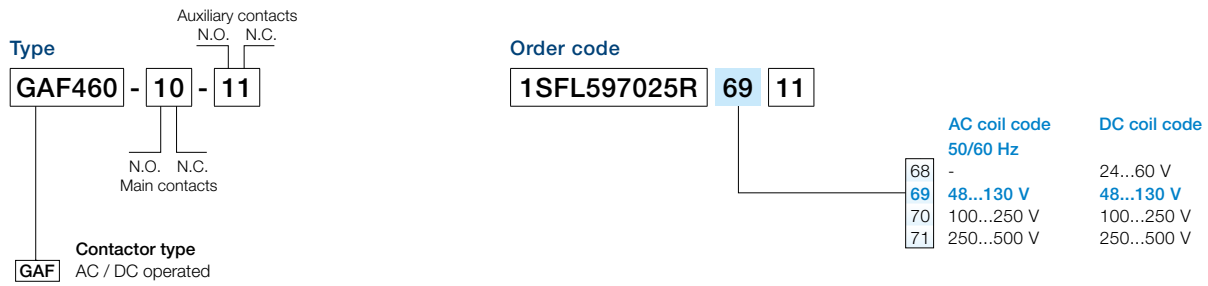

## GAF1650, GAF2050 contactors

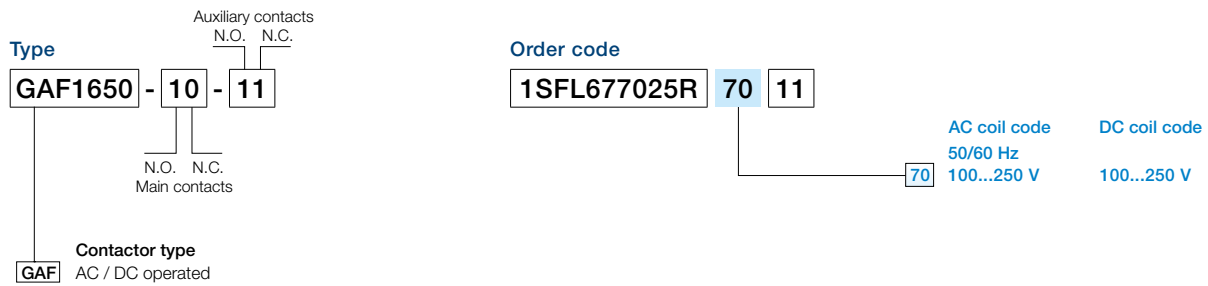



# Overload relays

## Overview

Thermal and electronic overload relays 7/2

## Thermal overload relays

T16	0.10...16 A	7/4
TF42	0.10...38 A	7/5
TF65	22...67 A	7/6
TF96	40 ... 96 A	7/7
TF140DU	66...142 A	7/8
TA200DU	66...200 A	7/9

## Electronic overload relays

E16DU	0.10 ... 18.9 A	7/10
EF19, EF45	0.10 ... 45 A	7/11
EF65, EF96, EF146	20 ... 150 A	7/12
EF205, EF370	63 ... 380 A	7/13
EF460, EF750	150 ... 800 A	7/14
E1250DU	375 ... 1250 A	7/15

## General accessories

WRH, WRB 7/16

For direct product details information, use product type or order code, ex:  
[www.abb.com/productdetails/AF09-30-10-13](http://www.abb.com/productdetails/AF09-30-10-13) or [www.abb.com/productdetails/1SBL137001R1310](http://www.abb.com/productdetails/1SBL137001R1310)

# Thermal and electronic overload relays

## Thermal overload relays

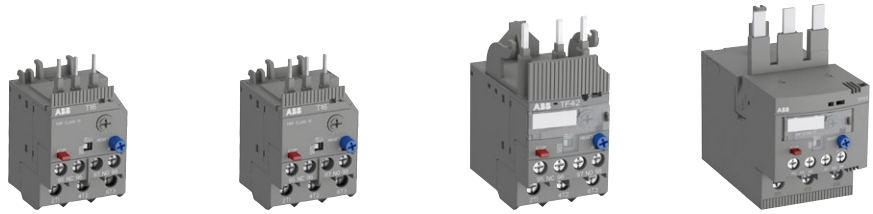

IEC: rated operational power AC-3	400 V	0.03 ... 4.0 kW	0.03 ... 4.0 kW	4.0 ... 18.5 kW	18.5 ... 30 kW
UL/CSA: 3-phase hp-ratings	480 V	1/2 ... 5 hp	1/2 ... 10 hp	5 ... 20 hp	30 ... 60 hp
Fitting to contactors		B6, B7	AS09 ... AS16	AF09 ... AF38	AF40, AF52, AF65
Type		<b>T16</b>	<b>T16</b>	<b>TF42</b>	<b>TF65</b>
Current range		0.10 ... 16 A	0.10 ... 16 A	0.10 ... 38 A	22 ... 67 A
Trip class		10	10	10	10
Single mounting kit		DB16	DB16	DB42	-

## 7 Electronic overload relays with integrated CT



IEC: rated operational power AC-3	400 V	4 ... 7.5 kW	4 ... 7.5 kW	4.0 ... 18.5 kW	18.5 ... 30 kW
UL/CSA: 3-phase hp-ratings	480 V	5 ... 10 hp	5 ... 10 hp	5 ... 20 hp	30 ... 60 hp
Fitting to contactors		B6, B7, BC6, BC7, A09 ... A16, AL09 ... AL16, VB6, VB7, VBC6, VBC7	AF09 ... AF16	AF26 ... AF38	AF40, AF52, AF65
Type		<b>E16DU</b>	<b>EF19</b>	<b>EF45</b>	<b>EF65</b>
Current range		0.10 ... 18.9 A	0.10 ... 18.9 A	9 ... 45 A	20 ... 70 A
Trip class		10E, 20E, 30E selectable			
Single mounting kit		DB16E	DB19EF	-	-

## Electronic overload relays with external separate CT

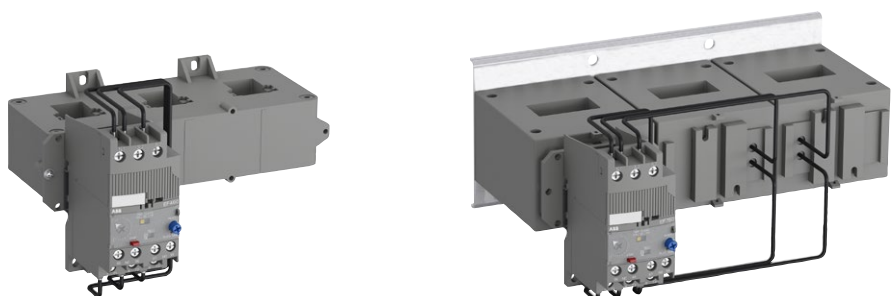

IEC: rated operational power AC-3	400 V	200 ... 250 kW	315 ... 400 kW
UL/CSA: 3-phase hp-ratings	480 V	350 ... 400 hp	500 ... 600 hp
Fitting to contactors		AF400, AF460	AF580, AF750, AF1250
Type		<b>EF460</b>	<b>EF750</b>
Current range		150 ... 500 A	250 ... 800 A
Trip class		10E, 20E, 30E selectable	

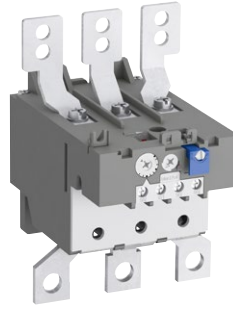

37 ... 45 kW

60 hp

AF80, AF96

**TF96**

40 ... 96 A

10

-

55 ... 75 kW

75 ... 100 hp

AF116, AF140

**TF140DU**

66 ... 142 A

10A

-

90 ... 110 kW

125 ... 150 hp

AF190, AF205

**TA200DU**

66 ... 200 A

10A

DB200



37 ... 45 kW

60 hp

AF80, AF96

**EF96**

36 ... 100 A

10E, 20E, 30E selectable

-

55 ... 75 kW

75 ... 100 hp

AF116, AF140, AF146

**EF146**

54 ... 150 A

-

90 ... 110 kW

125 ... 150 hp

AF190, AF205

**EF205**

63 ... 210 A

-

132 ... 200 kW

200 ... 350 hp

AF265, AF305, AF370

**EF370**

115 ... 380 A

-

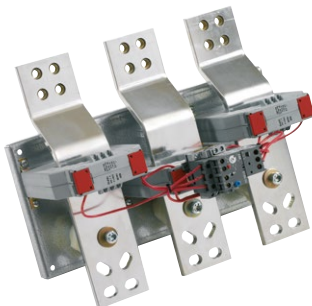

475 ... 560 kW

800 ... 900 hp

AF1350, AF1650

**E1250DU**

375 ... 1250 A

10E, 20E, 30E selectable

# T16 thermal overload relays

## 0.10 to 16.0 A



2CDC231009F0013

T16



2CDC231029F0013

T16 + DB16



1SFC151224F0002

KPR-101L



2CDC231002F0011

DB16

### Description

The T16 thermal overload relays are economic electromechanical protection devices for the main circuit. They offer reliable protection for motors in the event of overload or phase failure. The devices have trip class 10.

The thermal overload relays are three pole relays with bimetal tripping elements. The motor current flows through the bimetal tripping elements and heats them directly and indirectly. In case of an overload (over current), the bimetal elements bent as a result of the heating. This leads to a release of the relay and a change of the contacts switching position (95-96 / 97-98).

- Manual or automatic reset selectable
- Phase loss sensitive acc. to IEC/EN 60947-4-1
- TEST and STOP function - Trip indication on the front
- Temperature compensation
- Suitable for three- and single-phase applications

### Ordering details

Setting range	Short-circuit protective device	Trip class	Type	Order code	Weight (1 pc) kg
<b>A</b>					
0.10 ... 0.13	0.5 A, fuse type T	10	T16-0.13	1SAZ711201R1005	0.100
0.13 ... 0.17	1.0 A, fuse type T	10	T16-0.17	1SAZ711201R1008	0.100
0.17 ... 0.23	1.0 A, fuse type T	10	T16-0.23	1SAZ711201R1009	0.100
0.23 ... 0.31	1.0 A, fuse type T	10	T16-0.31	1SAZ711201R1013	0.100
0.31 ... 0.41	2.0 A, fuse type gG	10	T16-0.41	1SAZ711201R1014	0.100
0.41 ... 0.55	2.0 A, fuse type gG	10	T16-0.55	1SAZ711201R1017	0.100
0.55 ... 0.74	4.0 A, fuse type gG	10	T16-0.74	1SAZ711201R1021	0.100
0.74 ... 1.00	6.0 A, fuse type gG	10	T16-1.0	1SAZ711201R1023	0.100
1.00 ... 1.30	6.0 A, fuse type gG	10	T16-1.3	1SAZ711201R1025	0.100
1.30 ... 1.70	10.0 A, fuse type gG	10	T16-1.7	1SAZ711201R1028	0.100
1.70 ... 2.30	10.0 A, fuse type gG	10	T16-2.3	1SAZ711201R1031	0.100
2.30 ... 3.10	10.0 A, fuse type gG	10	T16-3.1	1SAZ711201R1033	0.100
3.10 ... 4.20	20.0 A, fuse type gG	10	T16-4.2	1SAZ711201R1035	0.100
4.20 ... 5.70	20.0 A, fuse type gG	10	T16-5.7	1SAZ711201R1038	0.100
5.70 ... 7.60	35.0 A, fuse type gG	10	T16-7.6	1SAZ711201R1040	0.100
7.60 ... 10.0	35.0 A, fuse type gG	10	T16-10	1SAZ711201R1043	0.104
10.0 ... 13.0	40.0 A, fuse type gG	10	T16-13	1SAZ711201R1045	0.104
13.0 ... 16.0	40.0 A, fuse type gG	10	T16-16	1SAZ711201R1047	0.104

### Ordering details accessories

Suitable for	Description	Type	Order code	Weight (1 pc) kg
T16	Single mounting kit	DB16	1SAZ701901R0001	0.032
T16	Reset push button*	KPR-101L	1SFA616162R1014	0.027

\*Note: for more information see catalogue 1SFC151004C0201

### Main dimensions mm, inches

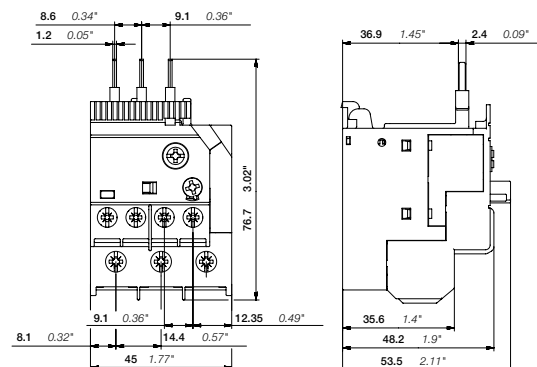

T16

2CDC232009F0008

2CDC106036C0201\_1s4

# TF42 thermal overload relays

## 0.10 to 38.0 A



2CDC231008F0013

TF42



2CDC231001F0011

DB42



2CDC231026F0013

TF42 + DB42



1SFC151224F0002

KPR-101L

### Description

The TF42 thermal overload relays are economic electromechanical protection devices for the main circuit. They offer reliable protection for motors in the event of overload or phase failure. The devices have trip class 10.

The thermal overload relays are three pole relays with bimetal tripping elements. The motor current flows through the bimetal tripping elements and heats them directly and indirectly. In case of an overload (over current), the bimetal elements bent as a result of the heating. This leads to a release of the relay and a change of the contacts switching position (95-96 / 97-98).

- Manual or automatic reset selectable
- Phase loss sensitive acc. to IEC/EN 60947-4-1
- TEST and STOP function – Trip indication on the front
- Temperature compensation
- Suitable for three- and single-phase applications

### Ordering details

Setting range	Short-circuit protective device	Trip class	Type	Order code	Weight (1 pc) kg
<b>A</b>					
0.10 ... 0.13	0.5 A, fuse type T	10	TF42-0.13	1SAZ721201R1005	0.130
0.13 ... 0.17	1.0 A, fuse type T	10	TF42-0.17	1SAZ721201R1008	0.130
0.17 ... 0.23	1.0 A, fuse type T	10	TF42-0.23	1SAZ721201R1009	0.130
0.23 ... 0.31	1.0 A, fuse type T	10	TF42-0.31	1SAZ721201R1013	0.130
0.31 ... 0.41	2.0 A, fuse type gG	10	TF42-0.41	1SAZ721201R1014	0.130
0.41 ... 0.55	2.0 A, fuse type gG	10	TF42-0.55	1SAZ721201R1017	0.130
0.55 ... 0.74	4.0 A, fuse type gG	10	TF42-0.74	1SAZ721201R1021	0.130
0.74 ... 1.00	6.0 A, fuse type gG	10	TF42-1.0	1SAZ721201R1023	0.130
1.00 ... 1.30	6.0 A, fuse type gG	10	TF42-1.3	1SAZ721201R1025	0.130
1.30 ... 1.70	10.0 A, fuse type gG	10	TF42-1.7	1SAZ721201R1028	0.130
1.70 ... 2.30	10.0 A, fuse type gG	10	TF42-2.3	1SAZ721201R1031	0.130
2.30 ... 3.10	10.0 A, fuse type gG	10	TF42-3.1	1SAZ721201R1033	0.130
3.10 ... 4.20	20.0 A, fuse type gG	10	TF42-4.2	1SAZ721201R1035	0.130
4.20 ... 5.70	20.0 A, fuse type gG	10	TF42-5.7	1SAZ721201R1038	0.130
5.70 ... 7.60	35.0 A, fuse type gG	10	TF42-7.6	1SAZ721201R1040	0.130
7.60 ... 10.0	35.0 A, fuse type gG	10	TF42-10	1SAZ721201R1043	0.130
10.0 ... 13.0	40.0 A, fuse type gG	10	TF42-13	1SAZ721201R1045	0.130
13.0 ... 16.0	40.0 A, fuse type gG	10	TF42-16	1SAZ721201R1047	0.130
16.0 ... 20.0	63.0 A, fuse type gG	10	TF42-20	1SAZ721201R1049	0.145
20.0 ... 24.0	63.0 A, fuse type gG	10	TF42-24	1SAZ721201R1051	0.145
24.0 ... 29.0	63.0 A, fuse type gG	10	TF42-29	1SAZ721201R1052	0.145
29.0 ... 35.0	80.0 A, fuse type gG	10	TF42-35	1SAZ721201R1053	0.145
35.0 ... 38.0/40.0	80.0 A, fuse type gG	10	TF42-38	1SAZ721201R1055	0.145

### Ordering details accessories

Suitable for	Description	Type	Order code	Weight (1 pc) kg
TF42	Single mounting kit	DB42	1SAZ701902R0001	0.087
TF42	Reset push button*	KPR-101L	1SFA616162R1014	0.027

\*Note: for more information see catalogue 1SFC151004C0201

### Main dimensions mm, inches

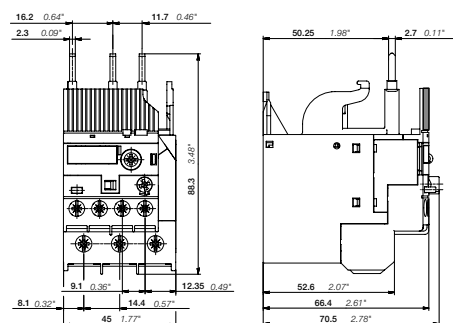

TF42

2CDC232005F0009

2CDC106046C0201\_1s4

# TF65 thermal overload relays

## 22.0 to 67.0 A



2CDC231004F0013

TF65



1SFC151224F0002

KPR-101L

7

### Description

The TF65 thermal overload relays are economic electromechanical protection devices for the main circuit. They offer reliable protection for motors in the event of overload or phase failure. The devices have trip class 10.

The thermal overload relays are three pole relays with bimetal tripping elements. The motor current flows through the bimetal tripping elements and heats them directly and indirectly. In case of an overload (over current), the bimetal elements bent as a result of the heating. This leads to a release of the relay and a change of the contacts switching position (95-96 / 97-98).

- Manual or automatic reset selectable
- Phase loss sensitive acc. to IEC/EN 60947-4-1
- TEST and STOP function - Trip indication on the front
- Temperature compensation
- Suitable for three- and single-phase applications

### Ordering details

Setting range	Short-circuit protective device	Trip class	Type	Order code	Weight (1 pc) kg
A					
22.0 ... 28.0	80 A, gG Type Fuses	10	TF65-28	1SAZ811201R1001	0.456
25.0 ... 33.0	80 A, gG Type Fuses	10	TF65-33	1SAZ811201R1002	0.456
30.0 ... 40.0	100 A, gG Type Fuses	10	TF65-40	1SAZ811201R1003	0.456
36.0 ... 47.0	125 A, gG Type Fuses	10	TF65-47	1SAZ811201R1004	0.456
44.0 ... 53.0	125 A, gG Type Fuses	10	TF65-53	1SAZ811201R1005	0.456
50.0 ... 60.0	125 A, gG Type Fuses	10	TF65-60	1SAZ811201R1006	0.466
57.0 ... 67.0	160 A, gG Type Fuses	10	TF65-67	1SAZ811201R1007	0.466

### Ordering details accessories

Suitable for	Description	Type	Order code	Weight (1 pc) kg
TF65	Reset push button*	KPR-101L	1SFA616162R1014	0.027

\*Note: for more information see catalogue 1SFC151004C0201

### Main dimensions mm, inches

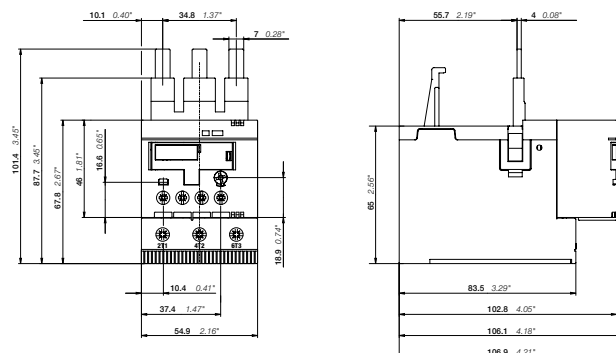

TF65

2CDC231004F0009

2CDC106063C0201\_1s4



# TF96 thermal overload relays

## 40.0 to 96.0 A



TF96

2CDC231005F0013



KPR-101L

1SFC151224F0002

### Description

The TF96 thermal overload relays are economic electromechanical protection devices for the main circuit. They offer reliable protection for motors in the event of overload or phase failure. The devices have trip class 10.

The thermal overload relays are three pole relays with bimetal tripping elements. The motor current flows through the bimetal tripping elements and heats them directly and indirectly. In case of an overload (over current), the bimetal elements bent as a result of the heating. This leads to a release of the relay and a change of the contacts switching position (95-96 / 97-98).

- Manual or automatic reset selectable
- Phase loss sensitive acc. to IEC/EN 60947-4-1
- TEST and STOP function – Trip indication on the front
- Temperature compensation
- Suitable for three- and single-phase applications

### Ordering details

Setting range	Short-circuit protective device	Trip class	Type	Order code	Weight (1 pc) kg
A					
40.0 ... 51.0	125 A, gG Type Fuses	10	TF96-51	1SAZ911201R1001	0.620
48.0 ... 60.0	160 A, gG Type Fuses	10	TF96-60	1SAZ911201R1002	0.620
57.0 ... 68.0	160 A, gG Type Fuses	10	TF96-68	1SAZ911201R1003	0.620
65.0 ... 78.0	200 A, gG Type Fuses	10	TF96-78	1SAZ911201R1004	0.620
75.0 ... 87.0	200 A, gG Type Fuses	10	TF96-87	1SAZ911201R1005	0.620
84.0 ... 96.0	250 A, gG Type Fuses	10	TF96-96	1SAZ911201R1006	0.630

### Ordering details accessories

Suitable for	Description	Type	Order code	Weight (1 pc) kg
TF96	Reset push button*	KPR-101L	1SFA616162R1014	0.027

\*Note: for more information see catalogue 1SFC151004C0201

### Main dimensions mm, inches

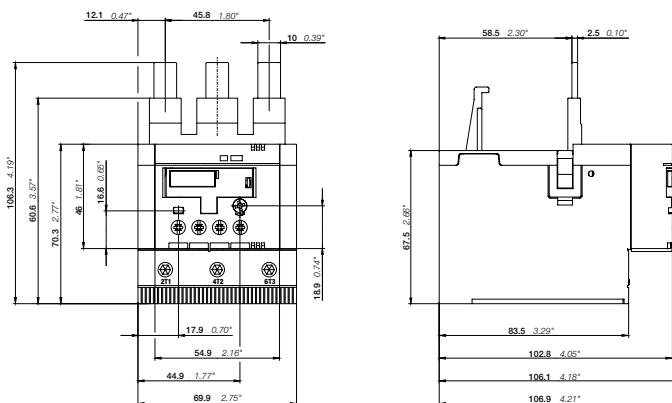

TF96

2CDC232005F0009

2CDC106064C0201\_1s4

# TF140DU thermal overload relays 66 to 142 A



2CDC231012P0012

TF140DU



1SFC151224F0002

KPR-101L

## Description

The TF140DU thermal overload relays are economic electromechanical protection devices for the main circuit. They offer reliable protection for motors in the event of overload or phase failure. The devices have trip class 10A.

The thermal overload relays are three pole relays with bimetal tripping elements. The motor current flows through the bimetal tripping elements and heats them directly and indirectly. In case of an overload (over current), the bimetal elements bent as a result of the heating. This leads to a release of the relay and a change of the contacts switching position (95-96 / 97-98).

- Manual or automatic reset selectable
- Phase loss sensitive acc. to IEC/EN 60947-4-1
- TEST and STOP function - Trip indication on the front
- Temperature compensation
- Suitable for three- and single-phase applications

## Ordering details

Setting range	Short-circuit protective device	Trip class	Type	Order code	Weight (1 pc) kg
<b>A</b>					
66 ... 90	200 A, fuse type gG	10A	TF140DU-90	1SAZ431201R1001	0.820
80 ... 110	224 A, fuse type gG	10A	TF140DU-110	1SAZ431201R1002	0.820
100 ... 135	224 A, fuse type gG	10A	TF140DU-135	1SAZ431201R1003	0.820
110 ... 142	250 A, fuse type gG	10A	TF140DU-142	1SAZ431201R1004	0.820

## Ordering details accessories

Suitable for	Description	Type	Order code	Weight (1 pc) kg
TF140DU	Reset push button*	KPR-101L	1SFA616162R1014	0.027

\*Note: for more information see catalogue 1SFC151004C0201

## Main dimensions mm, inches

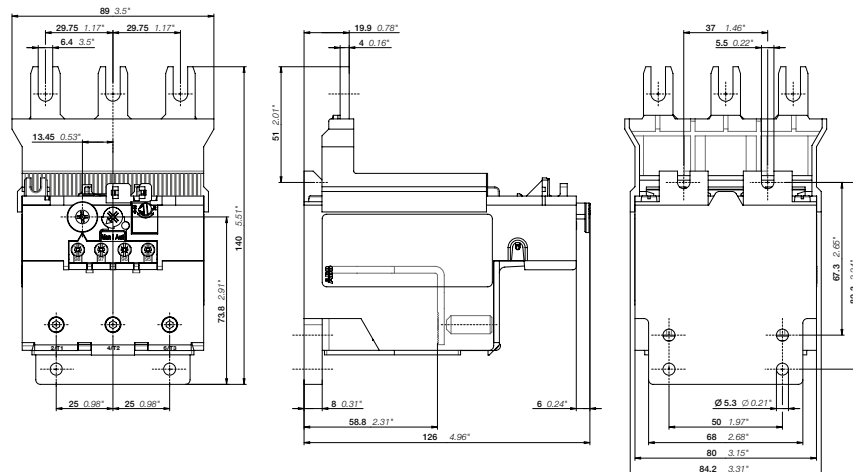

TF140DU

2CDC232008F0012

2CDC106054C0201\_1s4

# TA200DU thermal overload relays

## 66 to 200 A

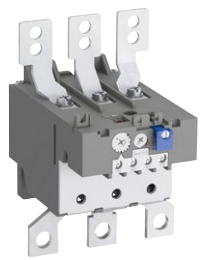

2CDC23016R0013

TA200DU



1SFC151224R0002

KPR-101L

### Description

The TA200DU thermal overload relays are economic electromechanical protection devices for the main circuit. They offer reliable protection for motors in the event of overload or phase failure. The devices have trip class 10A.

The thermal overload relays are three pole relays with bimetal tripping elements. The motor current flows through the bimetal tripping elements and heats them directly and indirectly. In case of an overload (over current), the bimetal elements bent as a result of the heating. This leads to a release of the relay and a change of the contacts switching position (95-96 / 97-98).

- Manual or automatic reset selectable
- Phase loss sensitive acc. to IEC/EN 60947-4-1
- TEST and STOP function – Trip indication on the front
- Temperature compensation
- Suitable for three- and single-phase applications

### Ordering details

Setting range	Short-circuit protective device	Trip class	Type	Order code	Weight (1 pc) kg
A					
66 ... 90	200 A, fuse type gG / 125 A aM	10A	TA200DU-90	1SAZ421201R1001	0.755
80 ... 110	224 A, fuse type gG / 160 A aM	10A	TA200DU-110	1SAZ421201R1002	0.760
100 ... 135	224 A, fuse type gG / 200 A aM	10A	TA200DU-135	1SAZ421201R1003	0.760
110 ... 150	250 A, fuse type gG / 200 A aM	10A	TA200DU-150	1SAZ421201R1004	0.760
130 ... 175	315 A, fuse type gG / 250 A aM	10A	TA200DU-175	1SAZ421201R1005	0.770
150 ... 200	315 A, fuse type gG / 250 A aM	10A	TA200DU-200	1SAZ421201R1006	0.785

### Ordering details accessories

Suitable for	Description	Type	Order code	Weight (1 pc) kg
TA200DU	Terminal shroud	LT200/A	1SAZ401901R1001	0.090
TA200DU	Single mounting kit	DB200	1SAZ401110R0001	0.225
TA200DU	Reset push button*	KPR-101L	1SFA616162R1014	0.027

\*Note: for more information see catalogue 1SFC151004C0201

### Main dimensions mm, inches

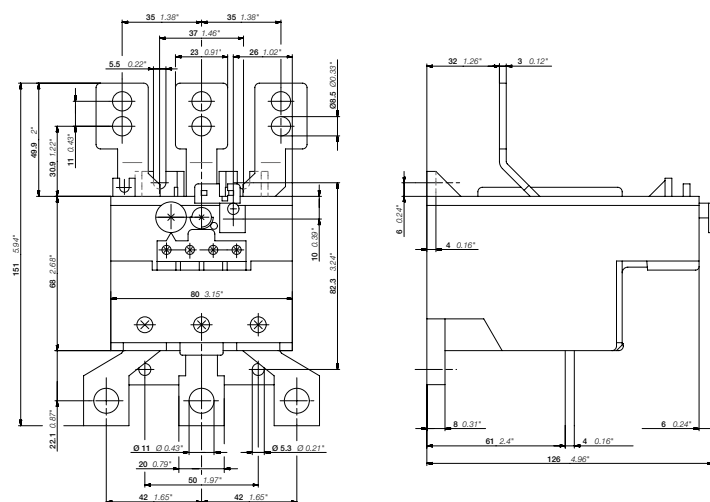

TA200DU

2CDC23021 F0011

2CDC106038C0201\_1s4

# E16DU electronic overload relays

## 0.10 to 18.9 A



2CDC231001F0007

E16DU-1.0



2CDC231003F0010

DB16E

7



1SFC151224F0002

KPR-101L

### Description

The E16DU is self-supplied electronic overload relays, which means no extra external supply is needed. It offers reliable protection for motors in the event of overload or phase failure. Easy to use like a thermal overload relay and compatible with standard motor applications, the electronic overload relay is convincing, above all, due to its wide setting range, high accuracy, high operational temperature range and the possibility to select a trip class (10E, 20E, 30E). Further features are the temperature compensation, trip contact (N.C.), signal contact (N.O.), automatic or manual reset selectable, trip-free mechanism, STOP and TEST function and a trip indication. The overload relays are connected directly to the contactors.

### Ordering details

Setting range	Short-circuit protective device	Trip class	Type	Order code	Weight (1 pc) kg
A					
<b>E16DU electronic overload relays</b>					
0.10 ... 0.32	1 A, fuse type gG	10E, 20E, 30E	E16DU-0.32	1SAX111001R1101	0.150
0.30 ... 1.00	4 A, fuse type gG	10E, 20E, 30E	E16DU-1.0	1SAX111001R1102	0.150
0.80 ... 2.70	10 A, fuse type gG	10E, 20E, 30E	E16DU-2.7	1SAX111001R1103	0.150
2.00 ... 6.30	20 A, fuse type gG	10E, 20E, 30E	E16DU-6.3	1SAX111001R1104	0.150
5.70 ... 18.9	50 A, fuse type gG	10E, 20E, 30E	E16DU-18.9	1SAX111001R1105	0.150

### Ordering details accessories

Suitable for	Description	Type	Order code	Weight (1 pc) kg
E16DU	Single mounting kit	DB16E	1SAX101110R0001	0.035
E16DU	Reset push button*	KPR-101L	1SFA616162R1014	0.019

\*Note: for more information see catalogue 1SFC151004C0201

### Main dimensions mm, inches

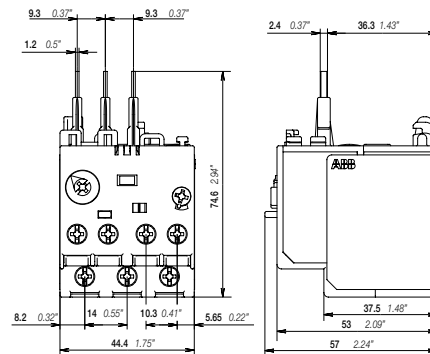

E16DU

2CDC232007F0011

2CDC107032C0201\_1s4

# EF19, EF45 electronic overload relays

## 0.10 to 45.0 A



1SBC101147F0010

EF19-18.9



1SBC101148F0010

EF45-30

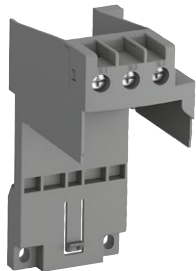

2CDC231024V0013

DB19EF



2CDC231022V0014

DB45EF



1SFC151224F0002

KPR-101L

### Description

The EF19 and EF45 are self-supplied electronic overload relays, which means no extra external supply is needed. It offers reliable protection for motors in the event of overload or phase failure. Easy to use like a thermal overload relay and compatible with standard motor applications, the electronic overload relay is convincing, above all, due to its wide setting range, high accuracy, high operational temperature range and the possibility to select a trip class (10E, 20E, 30E). Further features are the temperature compensation, trip contact (N.C.), signal contact (N.O.), automatic or manual reset selectable, trip-free mechanism, STOP and TEST function and a trip indication. The overload relays are connected directly to the contactors.

### Ordering details

Setting range	Short-circuit protective device	Trip class	Type	Order code	Weight (1 pc) kg
<b>A</b>					
<b>EF19 electronic overload relays</b>					
0.10 ... 0.32	1 A, fuse type gG	10E, 20E, 30E	EF19-0.32	1SAX121001R1101	0.158
0.30 ... 1.00	4 A, fuse type gG	10E, 20E, 30E	EF19-1.0	1SAX121001R1102	0.158
0.80 ... 2.70	10 A, fuse type gG	10E, 20E, 30E	EF19-2.7	1SAX121001R1103	0.158
1.90 ... 6.30	20 A, fuse type gG	10E, 20E, 30E	EF19-6.3	1SAX121001R1104	0.158
5.70 ... 18.9	50 A, fuse type gG	10E, 20E, 30E	EF19-18.9	1SAX121001R1105	0.158
<b>EF45 electronic overload relays</b>					
9.00 ... 30.0	160 A, fuse type gG	10E, 20E, 30E	EF45-30	1SAX221001R1101	0.362
15.0 ... 45.0	160 A, fuse type gG	10E, 20E, 30E	EF45-45	1SAX221001R1102	0.362

### Ordering details accessories

Suitable for	Description	Type	Order code	Weight (1 pc) kg
EF19	Single mounting kit	DB19EF	1SAX101910R1001	0.046
EF45	Single mounting kit	DB45EF	1SAX201910R0001	0.100
EF19, EF45	Reset push button*	KPR-101L	1SFA616162R1014	0.019

\*Note: for more information see catalogue 1SFC151004C0201

### Main dimensions mm, inches

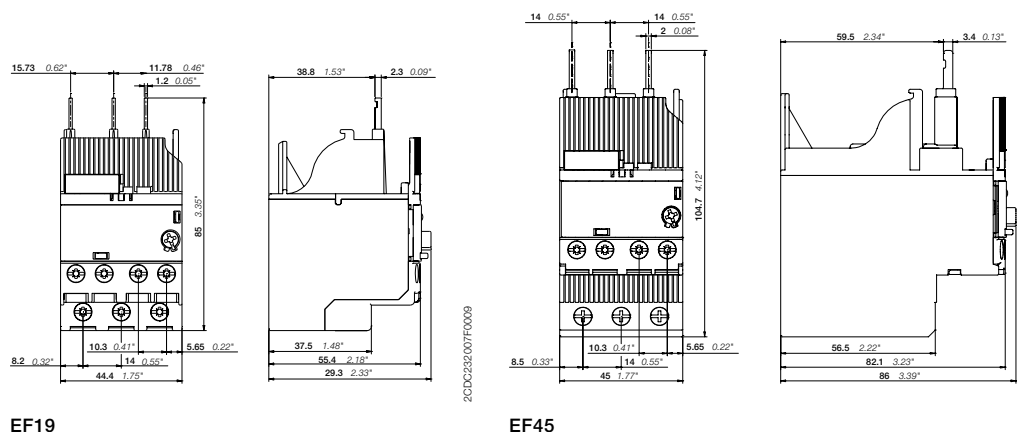

# EF65, EF96, EF146 electronic overload relays 20 to 150 A



2CDC231001F0012

EF65-70



2CDC231002F0012

EF96-100

7



2CDC231003F0012

EF146-150



1SFC151224F0002

KPR-101L

## Description

The EF65, EF96 and EF146 are self-supplied electronic overload relays, which means no extra external supply is needed. It offers reliable protection for motors in the event of overload or phase failure. Easy to use like a thermal overload relay and compatible with standard motor applications, the electronic overload relay is convincing, above all, due to its wide setting range, high accuracy, high operational temperature range and the possibility to select a trip class (10E, 20E, 30E). Further features are the temperature compensation, trip contact (N.C.), signal contact (N.O.), automatic or manual reset selectable, trip-free mechanism, STOP and TEST function and a trip indication. The overload relays are connected directly to the contactors.

## Ordering details

Setting range	Short-circuit protective device	Trip class	Type	Order code	Weight (1 pc) kg
A					
20 ... 56	160 A, fuse type gG	10E, 20E, 30E	EF65-56	1SAX331001R1102	0.821
25 ... 70	160 A, fuse type gG	10E, 20E, 30E	EF65-70	1SAX331001R1101	0.821
36 ... 100	200 A, fuse type gG	10E, 20E, 30E	EF96-100	1SAX341001R1101	0.802
54 ... 150	315 A, fuse type gG	10E, 20E, 30E	EF146-150	1SAX351001R1101	0.879

## Ordering details accessories

Suitable for	Description	Type	Order code	Weight (1 pc) kg
EF65, EF96, EF146	Reset push button*	KPR-101L	1SFA616162R1014	0.019

\*Note: for more information see catalogue 1SFC151004C0201

## Main dimensions mm, inches

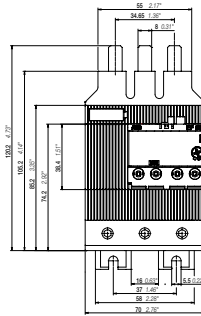

EF65-56 / EF65-70

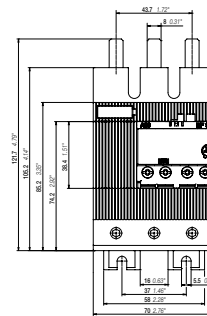
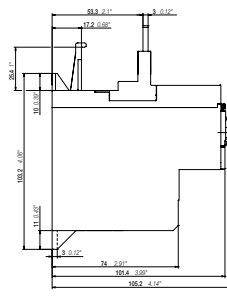

EF96-100

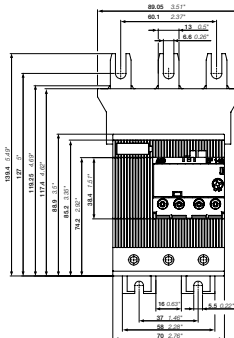

EF146-150

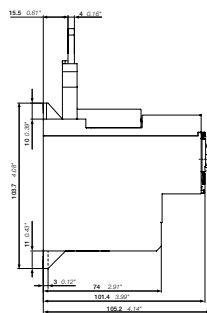

# EF205, EF370 electronic overload relays 63 to 380 A



2CDC231004F0012

EF205-210



2CDC231005F0012

EF370-380



1SFC151224F002

KPR-101L

## Description

The EF205 and EF370 are self-supplied electronic overload relays, which means no extra external supply is needed. It offers reliable protection for motors in the event of overload or phase failure. Easy to use like a thermal overload relay and compatible with standard motor applications, the electronic overload relay is convincing, above all, due to its wide setting range, high accuracy, high operational temperature range and the possibility to select a trip class (10E, 20E, 30E). Further features are the temperature compensation, trip contact (N.C.), signal contact (N.O.), automatic or manual reset selectable, trip-free mechanism, STOP and TEST function and a trip indication. The overload relays are connected directly to the contactors.

## Ordering details

Setting range	Short-circuit protective device	Trip class	Type	Order code	Weight (1 pc) kg
A					
63 ... 210	1250 A, fuse type gG	10E, 20E, 30E	EF205-210	1SAX531001R1101	1.210
115 ... 380	1600 A, fuse type gG	10E, 20E, 30E	EF370-380	1SAX611001R1101	1.430

## Ordering details accessories

Suitable for	Description	Type	Order code	Weight (1 pc) kg
EF205, EF370	Reset push button*	KPR-101L	1SFA616162R1014	0.027

\*Note: for more information see catalogue 1SFC151004C0201

## Main dimensions mm, inches

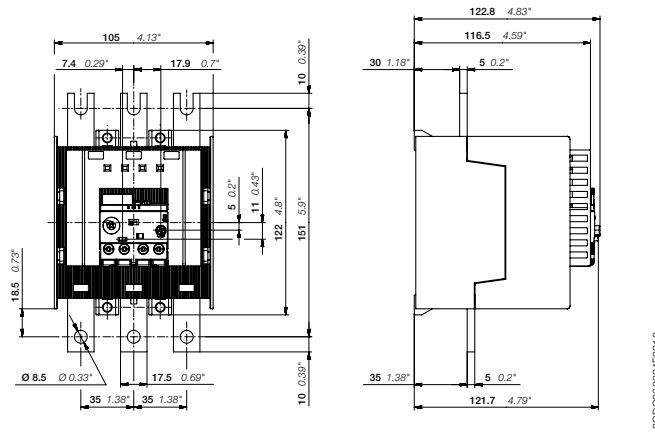

EF205-210

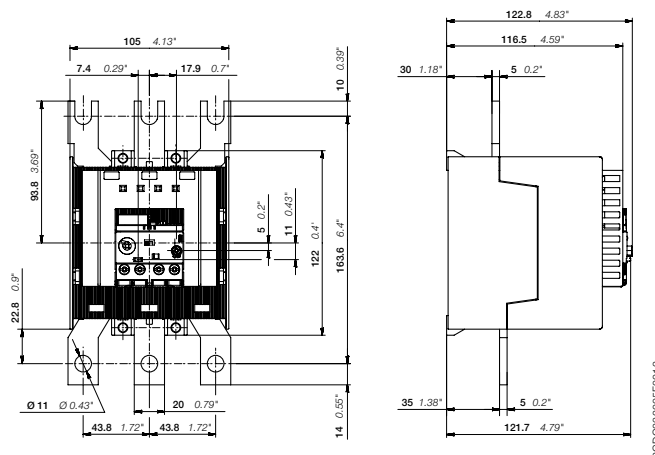

EF370-380

# EF460, EF750 electronic overload relays 150 to 800 A



2CDC231016F0013

EF460-500

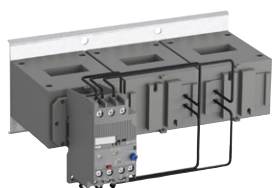

2CDC231014F0013

EF750-800



1SFC151224F0002

KPR-101L

## Description

The EF460 and EF750 are self-supplied electronic overload relays, which means no extra external supply is needed. It offers reliable protection for motors in the event of overload or phase failure. Easy to use like a thermal overload relay and compatible with standard motor applications, the electronic overload relay is convincing, above all, due to its wide setting range, high accuracy, high operational temperature range and the possibility to select a trip class (10E, 20E, 30E). Further features are the temperature compensation, trip contact (N.C.), signal contact (N.O.), automatic or manual reset selectable, trip-free mechanism, STOP and TEST function and a trip indication. Busbar kits are available as accessory for contactor mounting.

## Ordering details

Setting range	Short-circuit protective device	Trip class	Type	Order code	Weight (1 pc) kg
A					
<b>EF460 electronic overload relay</b>					
150 ... 500	690 V: 630 A, Type gG 1000 V: 1600 A, Type gG	10E, 20E, 30E	EF460-500	1SAX721001R1101	1.170
<b>EF750 electronic overload relay</b>					
250 ... 800	690 V: 800 A, Type gG 1000 V: 1600 A, Type gG	10E, 20E, 30E	EF750-800	1SAX821001R1101	3.905

## Ordering details accessories

Suitable for	Description	Type	Order code	Weight (1 pc) kg
EF460, EF750	Reset push button*	KPR-101L	1SFA616162R1014	0.027

\*Note: for more information see catalogue 1SFC151004C0201

## Main dimensions mm, inches

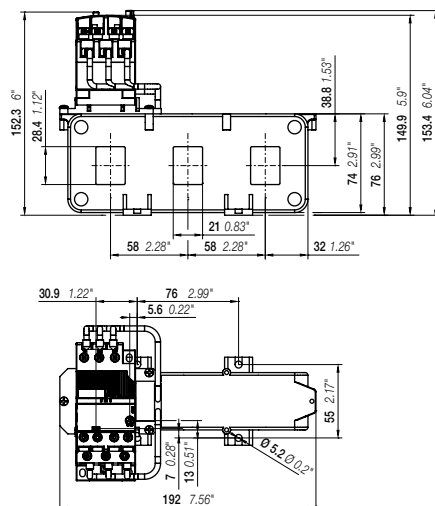

EF460-500

2CDC232008F0013

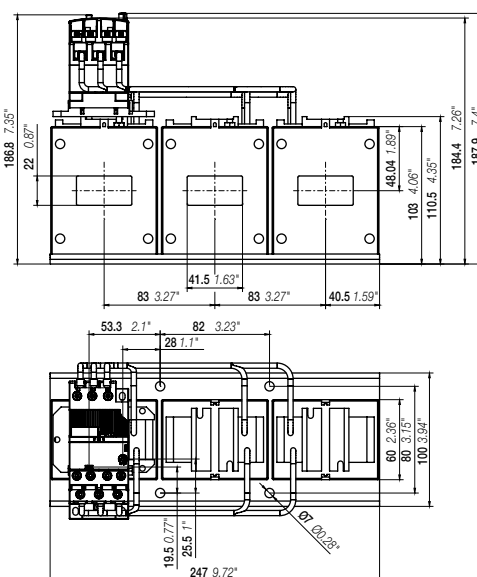

EF750-800

2CDC232008F0013

2CDC107045C0201\_163



# E1250DU electronic overload relays 375 to 1250 A

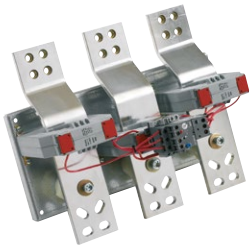

1SFA739001R1000

E1250DU-1250

## Description

The E1250DU are self-supplied electronic overload relays, which means no extra external supply is needed. It offers reliable protection for motors in the event of overload or phase failure. Easy to use like a thermal overload relay and compatible with standard motor applications, the electronic overload relay is convincing, above all, due to its wide setting range, high accuracy, high operational temperature range and the possibility to select a trip class (10E, 20E, 30E). Further features are the temperature compensation, trip contact (N.C.), signal contact (N.O.), automatic or manual reset selectable, trip-free mechanism, STOP and TEST function and a trip indication. Busbar kits are available as accessory for contactor mounting.

## Ordering details

Setting range	Short-circuit protective device	Trip class	Type	Order code	Weight (1 pc) kg
A					
<b>E1250DU electronic overload relay</b>					
375 ... 1250	-	10E, 20E, 30E	E1250DU-1250	1SFA739001R1000	12.181

# Thermal and electronic overload relays

## General accessories

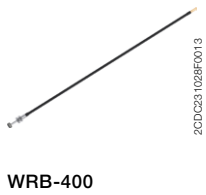

### Description

The wire reset is a general accessory for thermal and electronic overloads relays. In installations which are difficult to access, like a motor control centre or compact cubical, the accessory allows the user to remotely reset the overload relays.

The wire reset consists of two parts, the bowden wire with actuator and the holder. The actuator should be mounted into a door of a panel. The holder will be mounted on the overload relay. The actuator and holder are connected via the bowden wire.

### Ordering details

Suitable for	Description	Length mm	Type	Order code	Weight (1 pc) kg
<b>Holder</b>					
TF42, TF65, TF96, EF19, EF45, EF65, EF96, EF146, EF205, EF370, EF460, EF750	Holder for tool less direct mounting		WRH-F	1SAZ701903R1001	0.006
<b>Bowden wire with actuator</b>					
WRH-F	Bowden wire with actuator, hole diameter: 7.3 mm, maximum panel thickness: 12 mm	400	WRB-400	1SAZ701903R1011	0.030
		600	WRB-600	1SAZ701903R1012	0.040
		1000	WRB-1000	1SAZ701903R1013	0.060
<b>IP54 gasket</b>					
WRB-400 WRB-600 WRB-1000	IP54 Panel seal gasket		WRBG	1SAZ701903R1030	0.037

### Overload relays with accessory wire reset (WRH, WRB)

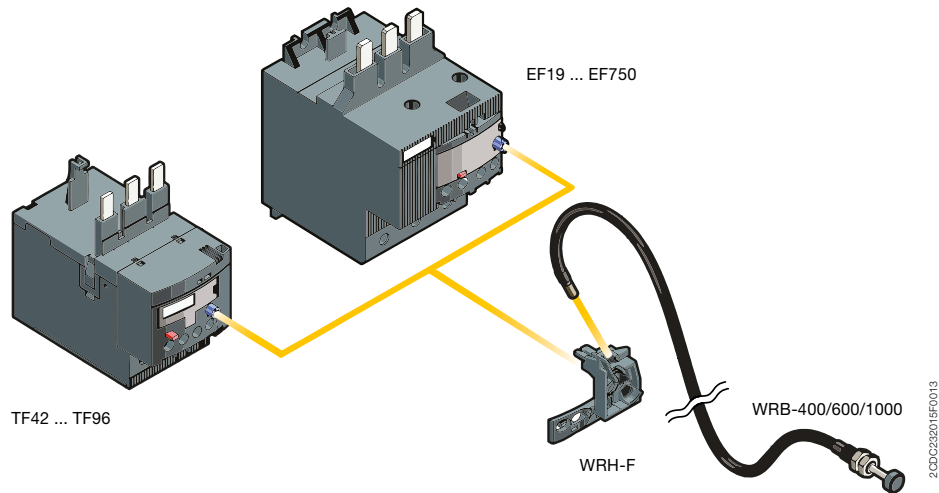

# Notes

A series of horizontal dotted lines for taking notes, spanning the width of the page.

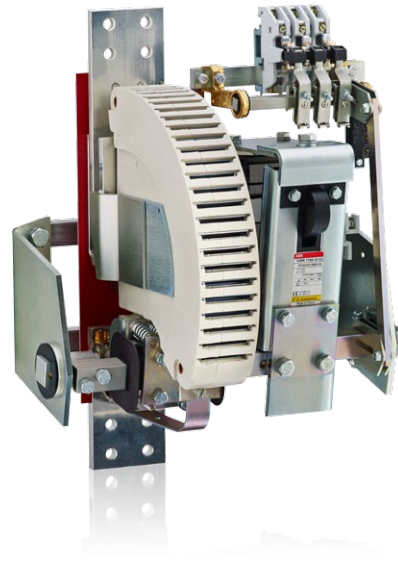
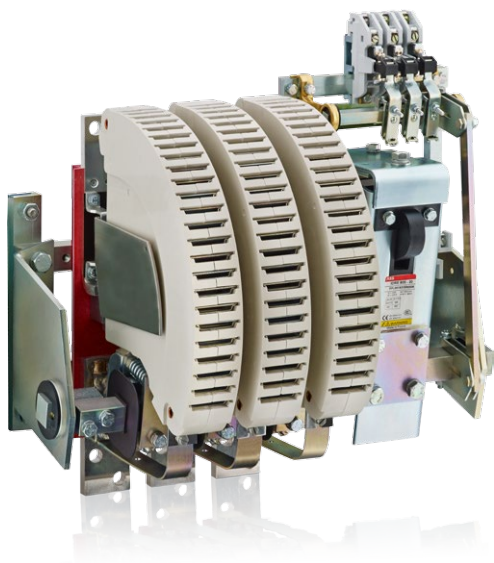

# R contactors

## Download



For additional information refer to our main catalog.

[Download main catalog](#)



Submit your request with the dedicated form. Our expert will define the right contactor for your application.

[Download the form](#)



# R contactors

## Tailored to your needs

With over 100 years of experience in control, ABB has designed its R contactors to meet the particular requirements of power applications from 63 A up to 5000 A in AC and DC.

With a variable number of poles and advanced features, these tailor-made bar mounted contactors remain the most flexible solution. Robustness and reliability bring our technology far beyond the limits of standard contactors. Our know-how enables us to offer R contactors perfectly suited to your applications whatever the environment.

### Performance

- High making and breaking capacity
- Current up to 5000 A
- Voltage up to 1000 V AC or 1500 V DC.

### Flexibility

- Variable number of poles
- Combination of N.O. and N.C. poles
- Adjustable number of auxiliary contacts.

### Reliability

- Robust construction
- Durability up to 5 millions of operating cycles
- Experienced and proven for years.

... you can trust

### Easy maintenance

- Direct access to all the contactor parts for inspection or replacement
- Complete and didactic instruction manual for installation, inspection or maintenance
- Dedicated R contactors service support available by ABB.

### From standard to tailor-made solution

- Pre-sales support to identify and define customer requirements
- Customized support with development of solutions from specifications
- Specialists available to optimize your configuration.

### Sustainability of control for a wide variety of applications

- Iron and steel industries
- Mining
- Cranes
- Induction furnaces
- Hydroelectric power stations
- Photovoltaic power plants
- Power distribution
- Energy storage
- Railway substation
- Lighting equipment
- Pump stations.



# R contactors

## Get the right product

### Conventional applications

#### AC circuit switching

Up to 500 V AC  
IOR contactors

From 500 up to 1000 V AC  
IOR..MT contactors

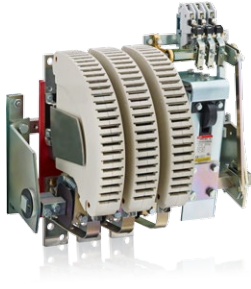

AC-1 Rated operational current up to 5000 A  
AC-3 Rated power up to 1500 kW (1520 A - 440 V)

#### DC circuit switching

Up to 1500 V DC with poles in series  
IOR..CC contactors



DC-1 Rated operational current up to 5000 A  
DC-3 / DC-5 operational current up to 2000 A

### Advanced applications

#### N.O./N.C. main poles combination

AC circuit switching  
NOR..MT contactors

DC circuit switching  
NOR..CC contactors



#### Power circuit coupling

Up to 1000 V AC / 1500 V DC  
LOR couplers



#### Slip-ring motor control

Up to 5000 V AC  
FOR contactors



#### Energy saving and safety requirements

Equipped with latching  
..AMA, ..AME contactor types

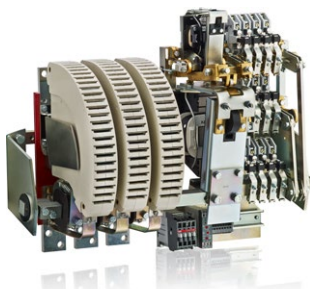

#### Alternator field discharge

U<sub>max</sub> 2250 V DC  
AM-CC-JORE contactors

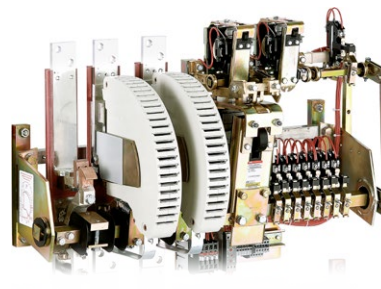

# Coordination with short-circuit protection devices

In compliance with standards IEC 60947-4-1 and EN 60947-4-1, we define for the contactors and starters the type, rating and characteristics of the short-circuit protection devices SCPD which allow selective protection against overloads and ensure protection against short circuits.

## Basic functions

Any starter is designed to:

- start motors,
- ensure continuous functioning of motors,
- disconnect motors from the supply line,
- guarantee protection of motors against overloads.

The starter is typically made up of a switching device (contactor) and an overload protection device (thermal overload relay or electronic overload relay).

These two devices MUST be coordinated with equipment capable of providing protection against short circuit (SCPD: short circuit protective device): typically a circuit breaker with magnetic release only or a switch fuse. These are not necessarily part of the starter.

## Applicable standards

IEC 60947-4-1 (EN 60947-4-1) precisely defines the different points to be considered in order to carry out correct coordination.

Complete coordination for a combination includes the following points:

- Selectivity test between the overload relay and the short-circuit protection device SCPD.
- Short-circuit condition tests:
  - at prospective "r" currents - These currents depend on the rated operational current of the starter (**I<sub>e</sub>** AC-3) and are given by the standard (Table 13). For example:
    - r = 1kA for **I<sub>e</sub>** AC-3 < 16 A
    - r = 3 kA for 16 A < **I<sub>e</sub>** AC-3 < 63 A
    - r = 5 kA for 63 A < **I<sub>e</sub>** AC-3 < 125 A etc.
  - at the rated conditional short-circuit current "**I<sub>q</sub>**" - This is the maximum prospective current that the combination can withstand, for example 50 kA.

9

## Types of coordination

IEC 60947-4-1 (EN 60947-4-1) defines two types of coordination according to the expected level of service continuity. Acceptable extreme damage for the switchgear is divided into two types.

**Type 1:** In short-circuit conditions, the contactor or starter does not endanger persons or installations and will not be able to then operate without being repaired or having parts replaced.

**Type 2:** In short-circuit conditions, the contactor or starter does not endanger persons or installations and will be able to operate afterwards. The risk of contacts light welding is acceptable. In this case, the manufacturer must stipulate the measures to be taken with respect to maintenance of the equipment.

## The complete ABB offer

ABB has acquired years of experience with respect to problems of coordination and is able to make a complete offer based on tests performed in its qualified laboratories. This offer includes 400 V, 500 V, 690 V networks.

**A complete data base of coordination tables**, according to IEC 60947-4-1 (EN 60947-4-1), is available on the ABB Website.

In the coordination tables the following short-circuit protection devices are recommended:

- Moulded case circuit-breakers (MCCBs)
- Miniature circuit-breakers (MCBs)
- Switch-disconnector-fuses (aM, gG and BS)
- Manual Motor Starters (MMS).

## General remarks applicable to all tables

- Each table is defined for a maximum ambient temperature of 40 °C. For higher temperatures, apply a derating factor according to the following rules:
  - Fuses: factor of 0.8 applied to **I<sub>n</sub>** for an ambient temperature of 70 °C
  - MCCBs and MCBs: factor of 0.8 applied to **I<sub>n</sub>** for an ambient temperature of 60 °C
  - The starter derating factor depends on the operating conditions of thermal overload relays:
    - Factor of 0.9 applied to **I<sub>n</sub>** for an ambient temperature of 70 °C.
- Each table is defined for motor currents: 3-phase motors, 4-pole
- **Normal starting** means a starting time < 2 s. - **Difficult starting** means an accelerating time 10 s < **t<sub>s</sub>** < 30 s
- **Tripping classes** of thermal overload relays according to IEC 60947-4-1 (EN 60947-4-1): 10A and 10
- **Tripping classes** of electronic overload relays according to IEC 60947-4-1 (EN 60947-4-1): 10E, 20E, 30E selectable
- In the tables with MCCBs, these are fitted with the magnetic relay alone. Setting is always carried out at > 12.3 **I<sub>e</sub>** AC-3 so that the transient current peak occurring during starting does not lead to tripping.



# Coordination with short-circuit protection devices

A complete data base of coordination tables, according to [IEC 60947-4-1](#) (EN 60947-4-1) or [UL 508 / UL 60947-4-1](#), is available on the ABB Website: see below.

## Selection

Simple or multiple selections all from the same screen.

### Short-circuit protection devices

- Air circuit breakers
- Fuses "gG" or "aM"
- Miniature circuit breaker
- Moulded case circuit breaker
- Manual motor starter

### Starter type

- Direct-on-line normal start
- Direct-on-line heavy duty
- Star-delta normal start
- Soft starter normal start

### Overload relay

- TOL : thermal overload relay
- EOL : electronic overload relay
- UMC : Universal motor controller

### Coordination

- IEC type 1 or type 2
- UL type A to Type F

## Results

- Search results displayed at the bottom of the selection page.
- Only the most appropriate solutions to your application, will be displayed at the bottom of the page.
- "Enable Smart Current Search" function featured for the short-circuit current where "near to" selected values also are included in the result.
- Possible to print the page to a pdf file or from your printer.
- "Clear selection" function to deselect all selected.

Fuses, 400 Vac, 100 kA, DOL-NS, Coordination Type IEC Type 2, Overload Relay TOL, Motor efficiency class IE1 + IE2									
Motor Rated Power [kW]	Rated Current [A]	Fuses IEC		Contactor Type	Overload Relay		Max allowed load current [A]	Table	
		Switch-Fuse Type	Rating gG/aM [A]		Type and Size	Type			
0,25	0,85	OS32GD_	2	CFAF 000aM	AF09	TF42-1,0	0,74 - 1,00	1,00	>>
0,12	0,44	OS32GD_	2	CFAF 000H	AF09	TF42-0,55	0,42 - 0,55	0,55	>>

Fuses, 400 Vac, 100 kA, DOL-NS, Coordination Type IEC Type 2, Overload Relay EOL, Motor efficiency class IE3									
Motor Rated Power [kW]	Rated Current [A]	Fuses IEC		Contactor Type	Overload Relay		Max allowed load current [A]	Table	
		Switch-Fuse Type	Rating gG/aM [A]		Type and Size	Type			
0,18	0,60	OS32GD_	2	CFAF 000aM	AF09	EF19-1,0 10*	0,30 - 1,00		>>
0,12	0,44	OS32GD_	2	CFAF 000H	AF09	EF19-1,0 10*	0,30 - 1,00		>>
0,12	0,44	OS32GD_	2	CFAF 000H	AF09	EF19-1,0 10*	0,30 - 1,00	0,54	>>
0,18	0,60	OS32GD_	2	CFAF 000aM	AF09	EF19-1,0 10*	0,30 - 1,00	1,00	>>



### Access

To find the coordination tables for motor protection, please see:  
<http://applications.it.abb.com/SOC/Page/Selection.aspx>



















# Marketing material

<http://new.abb.com/low-voltage/products/motor-protection>

HOME • PRODUCTS • LOW VOLTAGE PRODUCTS • MOTOR PROTECTION AND CONTROL

GLOBAL SITE Power and productivity for a better world™ **ABB**

## Motor protection and control

### To keep it running, you need Control

ABB's motor protection and control offering is among the widest on the market. From system integrator, OEM, engineering consultant and distributor to panel builder and industrial end-user, our comprehensive range of motor starting solutions, products and services delivers the certainty of consistent quality and performance.



Are you looking for support or purchase information?  
↓ [Contact us](#)

### Highlights

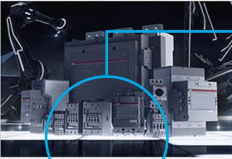

AF contactor launch



Gamesa chooses AF



ADL and Free Tech cuts logistic costs

### Our offering



Starting solutions  
Get the perfect match  
→ [Link](#)



Motor protection  
A complete motor protection concept  
→ [Link](#)



3-pole contactors and overload relays  
For motor starting and power switching  
→ [Link](#)



4-pole contactors  
For power switching  
→ [Link](#)



R bar contactors for advanced and heavy duty applications  
Tailored to your needs  
→ [Link](#)



Contactor relays  
For switching control and auxiliary circuits  
→ [Link](#)



Contactors for capacitor switching  
Withstand unlimited peak current  
→ [Link](#)



Contactors for DC switching  
For a compact and efficient way of DC switching  
→ [Link](#)



Contactors for railway applications  
Meeting the most stringent standards and requirements  
→ [Link](#)



Installation contactors  
Noiseless control  
→ [Link](#)

### Products and documents

Documents **Tools**

#### Download related documents for Contactors

You now see 5 documents within All documents (1989) → [Advanced search](#) → [Documents in all languages](#)

<b>Show all (1989)</b>	<b>ESB Installation contactors - Technical catalogue</b> Catalogue - English - 2010-02-08 - 0,66 MB <a href="#">↓ PDF</a>
<b>Popular documents (5)</b>	<b>ePLAN Electric P8 product data - Mini Contactors, Mini Contactor Relays, Mini Reversing Contactors and Accessories</b> Circuit diagram - English, German - 2011-06-17 - 0,08 MB <a href="#">↓ ZIP</a>
Brochure (10)	<b>Block contactors</b> Catalogue - English - 2005-01-27 - 5,80 MB <a href="#">↓ PDF</a>
CAD outline drawing (1)	<b>Main catalog Motor protection and control</b> Catalogue - English - 2013-06-04 - 94,02 MB <a href="#">↓ PDF</a>
Catalogue (30)	<b>Modular DIN rail components - Installation contactors</b> Brochure - English - 2014-03-27 - 0,75 MB <a href="#">↓ PDF</a>
Certificate (500)	
Circuit diagram (12)	
Course description (1)	

### News

2014-11-20 No job too dirty for ABB products	2014-11-06 Prost! ABB keeps Oktoberfest beer flowing	2014-09-26 ABB's Business Unit Control Products attends first Automation & Power World in Mexico	2014-07-24 Product of the year - ABB's AF contactor	2014-07-09 New ABB AF range contactors reduce SKUs by 90 percent	2014-06-19 ABB inaugurates new factory in Bulgaria
---	---	---	--	---	---

## Videos, prints, technical presentations and more



Videos



Success stories

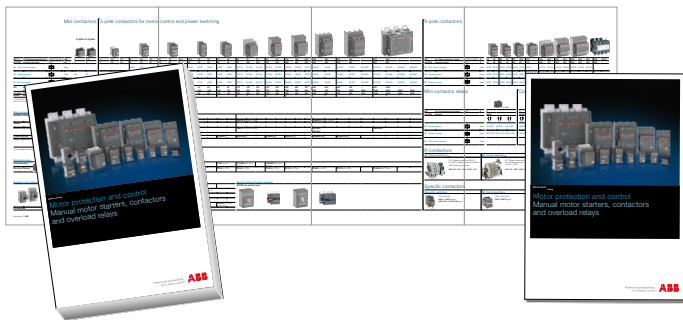

Main catalog : 1SBC100192C020  
 Short form catalog : 1SBC100195C0201  
 Panorama : 1SBC100191L0202

For direct product details information,  
 use product type or order code, ex:  
[www.abb.com/productdetails/AF09-30-10-13](http://www.abb.com/productdetails/AF09-30-10-13) or  
[www.abb.com/productdetails/1SBL137001R1310](http://www.abb.com/productdetails/1SBL137001R1310)

**Block Contactors**

Overview Data Contacts

---

**AF09-30-10-13**

**General information**

Extended Product Type: AF09-30-10-13  
 Product ID: 1SBL137001R1310  
 EAN: 3471223110038  
 Catalog Description: AF09-30-10-13 100-250V/50/60Hz DC Contactor

**Long Description:**  
 AF09 contactors are used for controlling power circuits up to 690 V AC and 220 V DC. They are mainly used for controlling 3-phase motors, non-inductive or slightly inductive loads. AF<sup>+</sup> contactors include an electronic coil interface accepting a wide control voltage DC min. - DC max. Only four coils cover control voltages between 24 - 500 V (500V/10 or 25 - 500 V DC). AF<sup>+</sup> contactors can manage large control voltage variations. One coil can be used for different control voltages used worldwide without any coil change. AF<sup>+</sup> contactors have built-in surge protection and do not require additional surge suppressors. The AF<sup>+</sup> series is track 3.



Print View  
Print to Pdf  
Download

## Userfriendly web design



## Tools

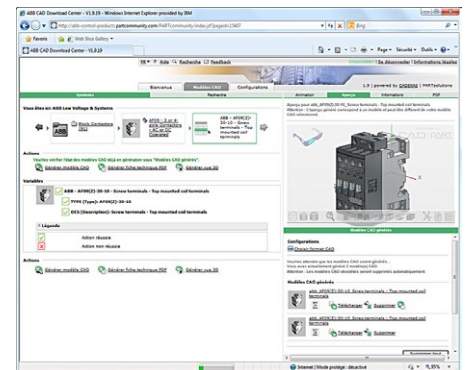

Cadenas portal: Download 2D or 3D files according to your needs (STEP, IGES...)

**Coordination tables for motor protection**

Selected Optimized Coordination

63 records (24 selected)

Protection Device	Rated Voltage	Short-Circuit Current (kA)	Starter Type	Coordination Type	Overcurrent Relay	Motor Name	Power (kW)
ABB	400V AC	5	DOL/NO	IEC Type 1	Embedded		0.06
ABB	400V AC	5	DOL/NO	IEC Type 2	TOC		0.06
ABB	400V AC	10	DOL/NO	UL Type A	EDL		0.09
ABB	400V AC	10	DOL/NO	UL Type D	AWC		0.10
ABB	400V AC	16	DOL/NO	UL Type D			0.10
ABB	400V AC	20	UL	UL Type D			0.17
ABB	400V AC	25	UL	UL Type D			0.20
ABB	400V AC	27					0.20
ABB	400V AC	27					0.10

**MFR: 400 Vac, 16 kA, DOL/NO, Coordination Type IEC Type 1, Overcurrent Relay, Embedded**

Motor Power (kW)	Rated Current (A)	Short-Circuit Current (kA)	Starter Type	Coordination Type	Overcurrent Relay	Motor Name	Power (kW)
0.06	0.20	10-15-25	AD	IEC	AWC		0.06
0.09	0.25	10-15-25	AD	IEC	AWC		0.09
0.10	0.25	10-15-25	AD	IEC	AWC		0.10
0.17	0.30	10-15-25	AD	IEC	AWC		0.17
0.20	0.30	10-15-25	AD	IEC	AWC		0.20

SOC II: Select the Optimized Coordination tables for your starter according to IEC or UL standard

**Helsinki**

tel. +358 9 540 4940  
automation@klinkmann.fi

**Yekaterinburg**

tel. +7 343 287 19 19  
yekaterinburg@klinkmann.spb.ru

**Vilnius**

tel. +370 5 215 1646  
post@klinkmann.lt

**St. Petersburg**

tel. +7 812 327 3752  
klinkmann@klinkmann.spb.ru

**Samara**

tel. +7 846 273 95 85  
samara@klinkmann.spb.ru

**Tallinn**

tel. +372 668 4500  
klinkmann.est@klinkmann.ee

**Moscow**

tel. +7 495 641 1616  
moscow@klinkmann.spb.ru

**Kiev**

tel. +38 044 495 33 40  
klinkmann@klinkmann.kiev.ua

**Minsk**

tel. +375 17 200 0876  
minsk@klinkmann.com

**Riga**

tel. +371 6738 1617  
klinkmann@klinkmann.lv